

Sweating done by red\_gonzo.

Note: sometimes formatting of the text may be a little fuzzy. It's all because the OCR process didn't go as smoothly as I expected. Also there may be some errors inside text so be vigilant. In any case share this book, send emails to people about knowledge contained in it. If you are an amateur electronic guy/girl try to make some good use of this knowledge and post your results. Try to use physics vocabulary as is presented in this book because as the author concludes, there are many good inventors around but they each use their own vocabulary and explanations of their inventions which are only understandable to them.

And please don't be naive and expect you'll be buying those devices in your local supermarket any time soon. Although some progress is being made it's still too slow, especially with the suppression factors watching over it. The knowledge has been handed to you and it's expected that at least a few of us make some use of it. Gather together and try to share your results with the rest of us.

TABLE OF CONTENTS:

|  |            |
|--|------------|
| Acknowledgements   | xi         |
| Foreword   | xiv        |
| Chapter 1  | 1          |
| Foundations and Scientific Mindset   | 1          |
| 1.1 Introduction.....  | 1          |
| 1.2 Organized Science Often Resists Innovative Change.....   | 24         |
| 1.3 Scientific Disagreement or Street Fight?.....  | 32         |
| 1.4 A Few Significant and Unresolved Scientific Problems.....  | 36         |
| 1.5 Electrodynamics is Still Developing.....   | 51         |
| 1.6 A Summarizing Letter.....  | 55         |
| Chapter 2  | 75         |
| Background and Concepts  | 75         |
| 2.1 Comments on the Foundations of Classical Electrodynamics ..  | 75         |
| 2.2 Lorentz Regauging of the Maxwell-Heaviside Equations.....  | 108        |
| 2.3 The Suicidal Closed Unitary Current Loop Circuit.....  | 119        |
| 2.4 In Summary.....  | 122        |
| <b>Chapter 3</b>   | <b>125</b> |
| <b>Giant Negentropy, Dark Energy, Spiral Galaxies and<br/>    Acceleration<br/>    of the Expanding Universe</b> | <b>125</b> |
| 3.1 Broken 5-Symmetry of the Dipole.....   | 127        |
| 3.2 Reinterpreting Whittaker's Decomposition of the Scalar<br>Potential.....                                     | 137        |
| 3.3 <b>How</b> the Dipole Charges Transduce Time Energy.....   | 141        |
| 3.4 Reordering of the Local Vacuum: Giant Negentropy.....  | 143        |

|  |            |
|--|------------|
| 3.5 Some Implications of Giant Negentropy.....                             | 143        |
| 3.6 How Circuits Are Powered.....  | 153        |
| 3.7 The Heaviside Component vs. the Poynting Component . . . .             | 155        |
| 3.8 Dark Positive Energy: The Unaccounted Heaviside<br>Component.....      | 157        |
| 3.9 A Short History of the Discarding of the Heaviside<br>Dark Energy..... | 158        |
| 3.10 The Problem of the Accelerating Expansion of the<br>Universe.....     | 164        |
| 3.11 In Conclusion.....  | 166        |
| <b>Chapter 4      171</b>  |            |
| <b>Setting the Stage for Understanding Overunity Power Systems</b>         | <b>171</b> |
| 4.1 Introduction.....  | 173        |
| 4.2 Demonstration Gedanken Experiment.....                                 | 180        |
| 4.3 Iterative Retroreflection and Collection in a Circuit.....             | 194        |
| 4.4 Tesla's Iterative Retroreflection Work.....                            | 197        |
| 4.5 Perspective on Tesla vs. Marconi.....                                  | 203        |
| 4.6 Conclusion.....  | 209        |
| <b>Chapter 5      219</b>  |            |
| <b>Selected Approaches to Overunity Power Systems      219</b>             |            |
| 5.1 Introduction.....  | 219        |
| 5.2 Tesla's Shuttling of Potential Energy and Barrett's<br>Extension.....  | 220        |
| 5.3 Moray's Radiant Energy Device.....                                     | 220        |
| 5.4 Anti-Stokes Emission and Similar Processes.....                        | 225        |
| 5.5 Gain in Intensely Scattering Optically Active Media.....               | 227        |
| 5.6 The Fiber Fuse.....  | 230        |
| 5.7 Multiple Feedforward and Feedback Semiconductor Loops. ..              | 235        |

|   |     |
|---|-----|
| <b>5.8 Negative Resistors</b> .....   | 236 |
| 5.9 Suppression of Free Energy Systems Has Been Common.....   | 288 |
| 5.10 In Conclusion.....   | 289 |
| <b>Chapter 6      293</b>   |     |
| <b>Additional Approaches to Overunity Power Systems    293</b>  |     |
| <b>6.1 Introduction</b> .....   | 294 |
| <b>6.2 Energy Conversion and Energy Amplification</b> .....   | 295 |
| 6.3 Other Systems of Electrical Interest.....   | 304 |
| <b>6.4 Some Magnetic Processes of Interest</b> .....  | 341 |
| 6.5 Conclusion.....   | 381 |
| <b>Chapter 7      385</b>   |     |
| <b>Aharonov-Bohm Effect, Geometric Phase, and the Motionless<br/>Electromagnetic Generator (MEG)    385</b> |     |
| 7.1 Introduction.....   | 387 |
| 7.2 Aharonov-Bohm (Geometric Phase) Effect.....   | 390 |
| 7.3 Abbreviated History of the Geometric Phase.....   | 391 |
| 7.4 Possible New Aspect of the Curl-Free Magnetic Vector<br><b>Potential</b> .....                          | 393 |
| 7.5 Use of Aharonov-Bohm Effect in the MEG.....   | 397 |
| <b>7.6 Collection of Field Energy in the MEG</b> .....  | 403 |
| 7.7 Experimental Path to Development of the MEG.....  | 408 |
| <b>7.8 Additional MEG Functions</b> .....   | 411 |
| <b>7.9 In Conclusion</b> .....  | 419 |
| <b>Chapter 8      421</b>   |     |
| <b>Approach to Antigravity      421</b>   |     |
| <b>8.1 Introduction</b> .....   | 422 |
| 8.2 Selected Theories of Gravitation.....   | 423 |
| 8.3 Selected Antigravity and Inertial Engineering Research<br>Efforts.....                                  | 431 |



|   |     |
|---|-----|
| 8.4 The Author's Engineering Approach to Local Antigravity... | 454 |
| 8.5 In Conclusion .....                                       | 471 |

**Chapter 9      473**

**The Supersystem and Remarks on Gravity, Antigravity, and Testing 473**

|   |     |
|---|-----|
| 9.1 The Supersystem and Its Considerations .....                                      | 476 |
| 9.2 Differences between Effects in COP»1.0 and COP<1.0<br>EM Systems.....             | 479 |
| 9.3 Primarily Concerned With Dirac Sea Holes and Not Lattice<br>Holes.....            | 487 |
| 9.4 Peculiarities of Spacetime Curvature and Dirac Hole<br>Interactions.....          | 488 |
| 9.5 Charging and Discharging a Capacitor.....   | 490 |
| 9.6 The Open-Loop COP>1.0 EM Power System.....  | 495 |
| 9.7 Remarks on Dirac Sea Holes, Currents, and Negative<br>Energy.....                 | 501 |
| 9.8 Remarks on the Observed Acceleration of the Expanding<br>Universe.....            | 505 |
| 9.9 A Solution to the Hole Current Problem and Close-Looping..                        | 509 |
| 9.10 Negative Energy: Localized and Nonlocalized.....                                 | 510 |
| 9.11 Tests Reinforcing the Antigravity Mechanism.....                                 | 514 |
| 9.12 Susceptible Unitary System without Conversion of<br>Dirac Sea Hole Current ..... | 519 |
| 9.13 Unitary System with Conversion of Dirac Sea<br>Hole Current.....                 | 521 |
| 9.14 Non-unitary Outrigger Array System.....  | 521 |
| 9.15 Some Instrument Considerations.....  | 525 |
| 9.16 Still Anomalous Aspects.....   | 528 |

**Chapter 10      537**

|   |            |
|---|------------|
| <b>Cold Fusion: Low Spatial-Energy Nuclear Reactions at High Time-Energy</b>            | <b>537</b> |
| 10.1 Explaining Time as Energy.....   | 539        |
| 10.2 Mechanism Generating Flow of a Mass through Time .....                             | 540        |
| 10.3 Time-Polarized EM Waves and Longitudinal EM Waves....                              | 542        |
| 10.4 Time Reversal Zone and New Nuclear Reaction Mechanisms.....                        | 554        |
| 10.5 Revision of the Conservation of Energy Law.....                                    | 560        |
| 10.6 Some Resulting <i>Low Spatial Energy</i> Nuclear Reactions.....                    | 566        |
| 10.7 Time-Energy Can Generate Instrumentation Anomalies.....                            | 570        |
| 10.8 Additional Implications for the Future.....  | 577        |
| <b>Chapter 11</b>   | <b>583</b> |
| <b>Final Perspective: Permissible COP&gt;1.0 Maxwellian Systems</b>                     | <b>583</b> |
| 11.1 Introduction.....  | 583        |
| 11.2 Source Charges, Curved Spacetime, Efficiency, and COP....                          | 585        |
| 11.3 Truncations of Maxwell's Theory and Discard of System Classes.....                 | 590        |
| 11.4 Examples of COP>1.0 Electromagnetic Systems.....                                   | 594        |
| 11.5 Motionless Electromagnetic Generator (MEG).....                                    | 596        |
| 11.6 Physical Considerations of Gauge Freedom.....                                      | 599        |
| 11.7 Special Modeling of the Vacuum.....  | 600        |
| 11.8 Every Charge and Dipole in an EM System Receives and Transduces Vacuum Energy..... | 601        |
| 11.9 Energy from the Vacuum Powers Every Electrical Power Line and EM Circuit.....      | 601        |
| 11.10 Significant Developments in Negative Resistance.....                              | 602        |
| 11.11 In Conclusion.....  | 605        |
| <b>Annotated Glossary of Selected Terms</b>   | <b>609</b> |

|  |     |
|--|-----|
| Appendix                                   |     |
| A.....                                     | 739 |
| Appendix                                   |     |
| B.....                                     | 767 |
| Index(notincludedbecauseyoucansearchinPDF) | 774 |
| ENDNOTES                                   | 849 |

# Acknowledgements

This book is dedicated to those lone researchers and stalwart inventors who have succeeded in building working model COP>1.0 electrical systems in the face of overwhelming odds and strong scientific opposition. We particularly mention Gabriel Kron, T. Henry Moray, John Bedini, Jim Watson, Ed Gray, Frank Golden, Floyd Sweet, Howard Johnson, Ken Shoulders, Bill Fogal, the Correas, and Teruo Kawai. There are quite a few others, of course, and no slight is intended by not listing all their names.

Also, I particularly acknowledge the contributions of my long-suffering close colleagues Dr. Lee Kenny, Dr. Jim Hayes, Ken Moore, and Steve Patrick, whose efforts on the bench have produced the working motionless electromagnetic generator (MEG) experiments as well as several variants. Our first MEG patent was issued in April 2002 and a second patent application has been filed. The MEG represents the first practical macroscopic application of the geometric phase (extended Aharonov-Bohm effect) for EM power systems. I particularly thank Lt. Col. (Retired) Ken Moore for watching my back and keeping me alive. I'm also grateful to both Dr. Fred Wood Sr. and Dr. Fred Wood Jr. for their personal support, action, and encouragement. I particularly acknowledge more than two decades of close cooperation and work with John Bedini, who is one of the most creative inventors on this planet; nearly a decade of work with Floyd Sweet and his vacuum triode amplifier; more than a decade of work with Frank Golden in COP>1.0 motors and uncurled A-potential communication systems; and a special thanks to Don Jensen for his important contributions and work in special combustion systems. Working with these inventors, I was able to physically examine working COP>1.0 power system prototypes and also experience and study the novel phenomenology that results in such systems.

With deep appreciation I acknowledge the kind assistance and helpful critiques of Dr. Myron W. Evans and other members of the Alpha Foundation's Institute for Advanced Study (AIAS) such as Alex Labounsky, Alain Beaulieu, and Bob Flower. Dr. Evans encouraged me to write down the basic concepts of the theory of permissible COP>1.0 Maxwellian systems I have been working on for three decades. This book is the result of that effort.

A special note of thanks goes to Dr. Dave Hamilton of the Department of Energy, who oversees a DoE restricted website provided for the important

**ongoing scientific work and drafts of the AIAS.** On that site, now there are more **than** 100 AIAS papers, many **of them dealing** with EM energy from the vacuum in rigorous fashion. Many of these AIAS draft papers have been published in leading journals such as *Foundations of Physics Letters*, *Physica Scripta*, *Optik*, etc. **This** is an invaluable scientific effort that clearly establishes the importance and potential for extracting copious EM energy directly from the active vacuum. It also extends the present U(1) electrodynamics to the much more extensive O(3) group symmetry electrodynamics, in which such things as I discuss in this book can indeed be accomplished on the bench and mathematically modeled.

The outstanding work and encouragement of Dr. Hal Fox and Dr. Eugene Mallove are particularly recognized, and I am grateful to them for their continued publication of important information and developments in cold fusion and the entire field of anomalous energy systems. I am also grateful to Dr. Robert Flower for his cogent explanations of some tough issues and points in quantum field theory that were beyond my ken before his explanation. Dr. Hal Puthoff introduced me to his cosmological feedback mechanism, and I am grateful for his important work with his colleagues in the areas of inertia, permissible thermodynamic extraction of energy from the vacuum, and possible mechanisms of antigravity.

A special thanks goes to Tim Ventura and to Jeffrey Cameron and the engineers of Transdimensional Technologies, Inc. for their courtesy and demonstrations of Transdimensional's successful lifter and rotary devices, and for an introduction to the field of inertial propulsion and antigravity now ongoing under the NASA Breakthrough Propulsion Physics (BPP) research program.

To Marcia Stockton I owe very special thanks indeed for her tireless efforts in reading and proofing the manuscript and translating the graphics. Also, I am much indebted to Michael Anderson for the art direction, and to Tony Craddock for making it possible. I am deeply grateful to Tony for his unfailing encouragement and support, and for operating and maintaining my website [www.cheniere.org](http://www.cheniere.org). I also deeply appreciate the continued contributions of Mike Rieker, of Network Innovations, who furnishes the website pro bono. A special thanks also goes to Dr. Steve Greer, who gave my wife and I great assistance and personal uplift at a time of personal tragedy. Dr. Greer has also now taken up the effort to develop and deploy practical electrical power systems, freely taking their EM energy from the vacuum.

Stalwart modern researchers in the overunity movement such as Jerry Decker and Walter Rosenthal are particularly to be commended for both their work, assistance to others, and their communication of work in the field. I am much indebted to Walt for furnishing the pictures of the closed-loop Sweet vacuum triode amplifier used in this book.

To Jean-Louis Naudin, I also am very grateful for his extraordinary experimental work and extensive publication of valuable information, his personal replication of a variety of systems, and his kind permission to use several illustrations in the book. His important website, <http://jnaudin.free.fr/>, is a cornucopia of information, experiments, and results in this entire area, with important links to many other appropriate web sites.

Also, to more than a dozen special persons — including those now passed on such as Glenn Foster and R. J. Reynolds III — who encouraged and supported these efforts through the years, I am very grateful. Throughout the years their kind words and friendship have made a very great difference to me personally and professionally, and they still do.

Finally and most importantly, I acknowledge the continuing and unwavering support of my dear wife, Doris, without whose encouragement and tolerance this work could never have been accomplished. She made all these long years of seven-day weeks and 18-hour days possible and humanly bearable. Without her, this book simply could not have been written.

# Foreword

The original purely scientific purpose of this book was interrupted en route by two events: The first was a sudden heart attack and onslaught of severe hypoxia resulting from the resurgence in Spring 2001 of a 33-year old chronic mycoplasma infection, of the modified biological warfare kind produced by a combined U.S./Canadian team, which got loose in Canada and Florida in the 1950s. I contracted this "mysterious, unknown ailment" in 1968 while in the U.S. Army and stationed in Quebec, Canada as the U.S. Army Liaison Officer to the Canadian Armament Research & Development Establishment (CARDE). The second event was the sudden terrorist attack on the U.S. on September 11, 2001, which propelled this nation and others into a war against international terrorism.

For the mycoplasma, Kenn Thomas recognized and informed me exactly what the difficulty was, and I was finally tested and diagnosed correctly in December 2001 due to the efforts of a courageous family physician. Accordingly, in December 2001 we started a yearlong (or longer) regimen of antibiotics and supplementary oxygen, with additional medication to control the runaway heart fibrillation associated with this virulent form of the disorder. If we make it through this yearlong program, we will probably survive with at least some significant recovery. Now on a much-reduced regimen, this made me realize the absolute necessity of passing the "energy from the vacuum" information and baton, so to speak, to those sharp young graduate students and post doctoral scientists who are interested in this area. They simply must not have to spend 30 years of their lives getting to this point. Instead, they should start where I am now, correct any errors I have inadvertently made, and go much farther.

Accordingly, we sharply changed the intent and content of the book to comply with that new purpose. We also deeply considered the potential U.S. and World energy implications of that second shocking event of 9/11 when international terrorists struck the World Trade Center in New York Center and the Pentagon, having also targeted the White House.

In the new asymmetric form of warfare, the internal aspects of a nation - its civilian population, its vulnerable installations, its energy infrastructure, its food crops, and its transportation modes — are the targets. Terrorist teams and groups in significant numbers are already inside every targeted developed nation, and these teams have weapons of mass destruction including biological weapons and even nuclear weapons. For confirmation

of the hostile nuclear weapons already secreted in large U.S. cities, read Lunev's book<sup>1</sup> to see how the former Soviet Union brought them in, along with the Spetznaz teams to detonate them on call. The nuclear weapons and the Spetznaz teams are still here. Other hostile nations have inserted terrorist teams with weapons such as anthrax, smallpox (camel pox is nearly identical to smallpox, and widely available), bubonic plague, etc. At the end of the 1991 Persian Gulf War, most of Iraq's calutrons and its nuclear program escaped the weapon inspectors and were hidden. In the few calutrons we did get, weapons-grade U235 residues were found. In a formal threat study for a foreign nation, begun before the Gulf War and delivered after its end, my analysis team and I estimated that Iraq had produced sufficient U235 in 1991 for from 7 to 12 nuclear weapons, particularly of the gun assembly type. My personal estimate now would be that Iraq has made sufficient weapons grade U235 to build three dozen to six dozen nuclear weapons. If so, then some of those weapons are undoubtedly long since spirited into the United States, and planted in our large cities.

In modern asymmetric strategic war, the first phase of the war is conducted in "peacetime". The first phase is to insert the weapons of destruction into the targeted nation and hide them at the intended targets, along with the teams to detonate and unleash the weapons when desired. In that sense, the first phase of WW III has already been accomplished.

According to Vice-President Cheney,<sup>2</sup> *"The war on terrorism will not be over in our lifetime. It is different than the Gulf War was in the sense that it may never end. At least not in our lifetime. The way I think of it is, it's a new normalcy."*

With much of the cheap oil of the world in its borders, the MidEast is a powder keg ready to explode. If a clash between the U.S. and Iraq occurs, Saddam Hussein has already clearly shown that he will attack and destroy his foe's energy infrastructure and he will also use weapons of mass destruction. Simply witness the hundreds of oil wells set afire in Kuwait by Iraqi forces during the Persian Gulf War, and the use of chemical weapons on his own people. As this is being written, Pakistan and India are skirting the brink of war, and both have nuclear weapons. Either side

<sup>1</sup> Stanislov Lunev and Ira Winkler, *Through the Eyes of the Enemy*, Regnery, Washington, D.C., 1998, p. 26.

<sup>2</sup> Vice President Richard B. Cheney, October 21, 2001.



that decides on war **will have to make a nuclear strike** on the other. They have no antimissile defenses, hence **making the "first knock-out"** or preemptive strike is each **nation's only chance of survival**. Hopefully cooler heads will prevail, but **If that war erupts**, the Mid East, oil, and present energy infrastructures will never again be the same, for the entire world.

There are other very serious U.S. vulnerabilities of gas and oil pipelines, port facilities, Gulf of Mexico oil rigs, nuclear power plants, power substations, hydroelectric dams, long power transmission lines on towers, etc. that are too numerous to enumerate. With but a moment's reflection, one realizes that even normal and cheap guerrilla-type or commando-type forces with C-4 explosives and timers can destroy a very substantial portion of the energy infrastructure with minimal risk and loss of assets. For those who wonder about a nuclear power plant's vulnerability, visualize a seized Boeing 747 loaded with fuel and flown directly into the main reactor container. If meltdown occurs, the nuclear tragedy at Chernobyl in 1986 will appear tame by comparison. There are also several other electromagnetic ways (such as a portable EMP "shooter" hauled in the back of a personal SUV) to instantly destroy the electronic controls of the nuclear power plant, seriously risking runaway and core meltdown.

Consequently, increasing attention is now focused on the extreme vulnerability of the centralized energy infrastructure in the U.S. and every other developed nation. So what started for me as a purely scientific endeavor to set out the concepts and principles of permissible COP>1.0 EM systems suddenly assumed a role of potentially critical strategic significance to the U.S. and to the entire developed world. Quite simply, some 20,000 terrorists in teams already in the United States can - at this very moment—destroy large portions of the nation's energy infrastructure at will, easily and cheaply. The economy of any modern developed nation depends on the availability of cheap energy. So this kind of hostile strategic capability means that the power to readily destroy a nation's economy — and thus defeat a mighty nation itself in the ensuing economic collapse — has passed into the hands of hostile forces already in country and awaiting the order to commit their assets.

In this new asymmetrical form of warfare, it would appear that the rapid development and deployment of significant distributed power sources is now a critical element of national survival for many nations of the world. Decentralization **does little good, however, if fuel** for the decentralized generators must remain **centralized and distributed** by very large and complex systems. The **fuel and its distribution** are still extremely **vulnerable resented easy targets allowing paralysis** of the decentralized

generators. Self-refueling (*self-powering*) of the electrical power systems is therefore a mandatory additional requirement.

So sober assessment dramatically reveals the need for self-powering electrical power systems, freely extracting their EM energy from the local vacuum. Thus an engineerable theory of permissible  $COP > 1.0$  EM systems has become essential to the national survival of the U.S. and many other nations, so that an effective decentralized energy infrastructure — with the seething vacuum as the "localized and inexhaustible free fuel supply" — can be rapidly designed, developed, and deployed.

Sadly, the leaders of the scientific community are still in a "business as usual" mode with respect to energy, and intend to remain so. They do not even recognize what powers and *always has* powered an EM circuit and system: EM field and potential energy extracted directly from the vacuum by the broken symmetry of the source charges and dipoles. Since no scientific research on EM energy from the vacuum is going to be launched by the scientific leaders at the top, then the results of the broken symmetry discovered in 1957 are going to have to be applied in the scientific community from the bottom up. Consequently, a rather desperate need to communicate everything possible to the young graduate students and post-docs has become imperative, if the nation is to survive.

From the beginning of my effort in  $COP > 1.0$  systems, and then my effort on this book and prior to the events leading to the attack on September 11, 2001, the appalling *humanitarian* need for  $COP > 1.0$  electrical power systems taking their energy from the vacuum has been obvious and overwhelming. One third of the human population usually goes to bed hungry at night. One third is infested with worms and parasites of one kind or another, in addition to other diseases. Simple things such as clean water, common sanitation, medical treatment, and jobs to support one's family are difficult things in many parts of the world.

In the final analysis, the only way to get a suffering, impoverished, and undeveloped nation up and going is to provide cheap clean energy, and to do it with systems which get their "fuel" for free, such as from the vacuum itself. Once cheap clean energy and self-powering systems are widely available, then the economy and infrastructure of that nation can be slowly and steadily built up to get the society moving. Roads, bridges, hospitals, schools, teachers, industry, and jobs then follow as the economy rises. Until there is a cheap energy infrastructure available and growing, essentially fuel-free, none of that is going to happen in most impoverished nations because presently the world's fuel is monopolized, controlled, and

**fought over**, and it will become even more expensive as the supply vs. **demand** ratio falls, prices escalate, and additional wars - almost certainly involving weapons of mass **destruction** - are engendered. With present aid concepts, at best the politicians and warlords usually get the bulk of whatever assistance is sent in, and the warlords on the take from foreign masters will continually plunge the country into turmoil, war, and human tragedy. *Assistance is necessary*, but the eventual aim has to be to enable and empower the common citizens to be self-supporting, educated and trained, relatively free from disease, and living in a nation having a growing and developing infrastructure, jobs, and a decent economy. Availability of cheap and affordable energy — and *clean* energy if we wish to save the precious environment — is the primary key to "freeing and empowering the developing nations" as well.

Along with this omnipresent, desperate humanitarian need, the increased strategic need for decentralized energy systems freely fueled from the vacuum itself has led me to make every effort possible — particularly after the heart attack in 2001 and in continued hypoxia from severe chronic mycoplasma infection — to finish the book and at least outline the major concepts and principles that enable the construction of a sorely-needed COP>1.0 electrical power systems theory, followed by the development and rapid deployment of actual self-powering systems. The Alpha Foundation's Institute for Advanced Study (AIAS), spearheaded by Dr. Myron Evans, has also been vigorously preparing and publishing papers in leading scientific journals and other publications<sup>3</sup> showing that EM energy from the vacuum is permissible, possible, and feasible.

In my three decades of work with multiple inventors of working prototype COP>1.0 electrical systems, I have been privileged to experience and work with several actual COP>1.0 circuits and prototype systems, study them, and slowly comprehend some of the advanced and unusual principles involved. In short, thanks to the courtesy and kindness of others, I have been able to gradually acquire at least an elementary understanding of the

<sup>3</sup> E.g. *Modern Nonlinear Optics*, Second Edition, 3 Vols., edited by M. W. Evans, Wiley, 2001; M. W. Evans et al, "Derivation of  $0(3)$  Electrodynamics from the Irreducible Representations of the Einstein Group," *Found. Phys. Lett.*, 15(2), Apr. 2002, p. 179-187; "Anti-Gravity Effects in the Sachs Theory of Electrodynamics," *Found. Phys. Lett.*, 14(6), Dec. 2001, p. 601-605; "Classical Electrodynamics Without **the Lorentz Condition: Extracting Energy** from the Vacuum," *Physica Scripta*, 61(5), May 2000. p. 513-517; "Runaway Solutions of the Lehnert Equations: The **Possibility of Extracting Energy from the Vacuum**," *Optik*, 111(9), 2000, p. 407-409.

mechanisms which enable  $COP > 1.0$  EM power systems. With this background, one can understand why conventional EM systems and circuits do not develop  $COP > 1.0$  or self-powering, even though all the energy collected and used in every electrical power system comes from the vacuum and not from the shaft energy input to the generator, chemical energy dissipated in a battery, wind energy collected by a windmill (that just "feeds" the shaft of the generator), or from the water power dissipated in a hydro turbine (the hydro turbine also only turns the shaft of the generator, which does not actually furnish the power to the external power line connected to it).

It seems appropriate that other researchers should be able to start where I am now, understand what I have learned or think I have learned, find and correct any errors, and simply go forward with alacrity — much farther than I have been able to go, and much faster. This is particularly true of the young researchers who have excellent theoretical and experimental skills and a vigorous lifetime ahead of them. When an old and tiring runner falters with the baton, it is time to pass it on to the fresh young runners who can carry it to the successful end of the race.

The purpose of this book, then, is to lay out in some little detail what I have learned in all these years of sustained effort, but in such a way that it ties directly into good physics. In some cases, the tie-in to physics is unavoidably to a somewhat esoteric area such as the geometric phase and to time as a special form of energy.  $COP > 1.0$  EM systems are not simple, and they involve special phenomenology rarely encountered in conventional EM circuits and systems.  $COP > 1.0$  EM systems simultaneously involve a combination of particle physics, modern active vacuum theory, advanced materials science, higher group symmetry electrodynamics, quantum mechanics, and general relativity. They also involve areas where foundations of physics are presently in error. We found it necessary to think in terms of the *supersystem*, defined as having three components, which are (i) the physical power system itself, (ii) the active local vacuum, and (iii) the active local curvatures of spacetime. All three components of the supersystem interact and exchange energy with each other continuously. Any legitimate  $COP > 1.0$  power system must freely receive, collect, and use some excess energy from its active environment — in this case, the latter two components of its supersystem. By definition, this  $COP > 1.0$  function requires disequilibrium between the system and its active environment, so that classical equilibrium thermodynamics does not apply. Instead, the thermodynamics of systems

far from **equilibrium** in **their** energetic exchange with an active environment applies.

However, since the "environmental energy" we are extracting is virtual photon energy from the vacuum and energy from local curved spacetime, the fundamental definitions of classical thermodynamics and classical electrodynamics have to be re-examined and altered. A closed system, e.g., can no longer be defined just as one closed to the transfer of mass across its boundary, but permitting energy to exchange across it. Since the advent of general relativity in 1915, we have known that energy and mass are the same thing. Whenever any system changes its energy, it also changes its mass by the well-known  $E = mc^2$  rewritten as  $dm = dE/(c^2)$ . Further, in the fierce virtual particle exchange of the vacuum with every part of every system, both virtual mass and virtual energy continually cross the system boundary. Neither classical thermodynamics nor classical electrodynamics deals with the transduction of time-energy into spatial energy in a system, which is a totally different type of energy exchange accomplished by charge.

Further, certain phenomenological areas — such as strong gradients — are already well known to violate present thermodynamics. These are presently being researched under the aegis of *extended nonreversible thermodynamics*. Finally, as the present laws of classical thermodynamics are stated in the textbooks, *every charge and dipole in the universe already violates those laws, and has done so since the beginning of the universe*. Let us put it bluntly: Every charge in the universe already freely and continuously pours out EM energy in 3-space in all directions, without any observable EM energy input. That is the well-concealed *source charge problem*, known but ignored by the leaders of the scientific community for a century. *All EM fields and potentials and their energy come from those source charges, according to electrodynamics itself*. Either we must give up the conservation of energy law entirely, or else we must accept the fact that unobservable *virtual* EM mass and energy are continuously absorbed

The vacuum by the source charge, transduced into real observable EM energy, and then re-radiated in 3-space in all directions as observable EM energy, creating the associated fields and potentials reaching out across the universe. That this problem continues to be ignored by the scientific community — some 45 years after the basis for its solution has been proven and is well known in particle physics — is totally inexplicable. But it continues to be resoundingly ignored, which means that *the scientific community itself is and remains totally responsible for the energy crisis and the associated vast despoilment of the biosphere, because it adamantly*

*insists on using a seriously flawed electrical energy science whose hoary basis is more than a century old.*

Accordingly, we have simply extended the first law of thermodynamics appropriately, pointed out that the second law does not apply absolutely but only as an approximation when conditions are appropriate, and revised the third law and the zeroth law. In this book we simply show the results of that revision, particularly in Appendix A.

We were also able to trace the history of electrodynamics, and to find exactly how the permissible Maxwellian systems far from equilibrium with an external active environment — which are included in Maxwell's 1865 seminal theory and even in Heaviside's vector truncation later — were arbitrarily discarded by Lorentz with his symmetrical regauging of the Maxwell-Heaviside equations. The purpose of such arbitrary regauging was and is to provide simpler equations that can usually be solved analytically without resorting to numerical methods. In the name of mathematical simplicity and ease, that entire great class of Maxwellian systems far from thermodynamic equilibrium in their supersystem was just arbitrarily discarded. Those Maxwellian systems are still arbitrarily discarded in every electrical power-engineering textbook today.

So the first requirement for a  $COP > 1.0$  EM system becomes *building-in a mechanism to violate the Lorentz symmetry condition, at least for a significant fraction of the time*. Further, the standard closed current loop circuit — including the entire external circuit in the same closed current loop as the source dipole inside the generator — is what already *self-enforces* the Lorentz symmetry condition. Consequently, in any legitimate  $COP > 1.0$  electrical system, the operation of that closed current loop circuit must be violated for some portion of the system's operation. This of course places the system in disequilibrium with its active supersystem environment, allowing intake of extra energy from the environment and therefore permitting  $COP > 1.0$ . So one of the immediate requirements in  $COP > 1.0$  electrical systems research is to seek out and find known or suspected mechanisms that accomplish just such violation of the Lorentz symmetry condition. In the book, I show a sampling of the various mechanisms I found other inventors using or that I uncovered myself, or that already exist in physics.

Finally, we discovered (and found the basis for it was shown in the hard literature in Heaviside's original work) that every generator and battery as an energy transducer already extracts from the vacuum and outputs from its terminals a far greater *nondiverged* energy flow than is accounted in the

**Poynting** diverged energy flow theory (which captures only that small **fraction that is diverged** into the circuit and captured by it). The total output energy flow from the terminals of a generator is also far greater than the mechanical energy input to the shaft of the generator. So in its *energy transduction* function, every dipolar electrical circuit ever built is already a "free energy circuit" and a COP  $\gg 1.0$  system, extracting its utilized electrical energy from the vacuum and extracting additional energy also. But presently the electrical power system is unwittingly designed and constructed by engineers to deliberately destroy the source of that enormous energy flow from the vacuum faster than the system can use some of it to power its load. Wryly put, that does not seem to be the proper way to build energy systems or "run an energy railroad," even though it's always been done that way.

This led to recognition of a great scientific faux pas, perhaps the greatest in history. One must keep one's sense of humor! So with tongue in cheek, let us state it this way: *There is not now, and there never has been, a single electrical engineering department, electrical engineering professor, or electrical engineering textbook that teaches what powers an electrical circuit. Yet the basis for it has clearly been in particle physics since 1957, as certified by the award of the Nobel Prize to Lee and Yang. What powers every electrical circuit and system is the broken symmetry of the primary power system's source charges and source dipole (i. e., the broken symmetry of the opposite charges on the ends of the dipole) in its fierce energy exchange with the seething vacuum, once that dipole has been made. The modern "charge" is also a dipolarity, once its associated clustering virtual charges of opposite sign are considered. Further, any dipole will freely extract EM energy from the vacuum, convert it into real, usable, observable EM energy, and pour out real, usable EM energy continuously and indefinitely, so long as the dipole remains intact.*

The external circuit attached to a generator is not powered by the mechanical energy that is input to the generator shaft. The external circuit attached to a battery is not powered by the chemical energy expended by the battery. Astonishingly, every electrical power system and electrical circuit ever built, and every one built today, was and is powered by energy extracted and transduced directly from the active vacuum by the broken symmetry of the opposite charges on the ends of the source dipole (or a charge considered as a modern dipolarity), once that dipole is formed. A Nobel Prize was awarded to Lee and Yang in 1957 for the prediction of broken symmetry (strongly in 1956). Wu and her colleagues proved it **experimentally** in early 1957. So revolutionary a change in physics was

that startling discovery of broken symmetry, that — in a nearly unparalleled action — the Nobel Committee awarded the Nobel Prize the same year, December 1957, to Lee and Yang. *One of the broken symmetries proven was that of opposite charges such as are on the opposite ends of every dipole, or such as constitute a classical "isolated charge" when the charge and its clustering virtual charges of opposite sign are considered as in modern physics theory. Rigorously, every source dipole is continuously extracting EM energy from the vacuum and pouring it out of the "terminals" of the dipole in all directions in 3-space. And so is every charge as well.* That the leaders of the scientific community continue to ignore this solidly proven fact is astonishing. But they do.

We also came to realize that the great Gabriel Kron, who was never allowed to reveal the secret of his *open path*, had in fact discovered the precursor of that very broken symmetry of opposite charges (of dipolarity). His open path is simply the recognition that any two points in the universe, that are at differing potentials and therefore can be considered as a dipolarity of opposite charges, acts as a source dipole that already extracts virtual photon energy from the vacuum, transduces it into real, observable photon energy, and pours out that energy in all directions. In reaching that understanding, he had applied general relativity to rotating electrical machines, simulated various forms of electromagnetics equations, and dealt deeply with quantum mechanics and the Schrodinger equation.

Sadly, the electrodynamics model used in electrical power engineering still does not even model the active vacuum, *much less* a broken symmetry in the virtual photon exchange between that active vacuum and all the charges in every electrical system. The electrical engineering model does not model the *supersystem*, hence cannot be used to design and produce COP>1.0 systems. *A priori*, that seriously truncated and crippled model arbitrarily discards all permissible Maxwellian systems far from thermodynamic equilibrium (i.e., with broken symmetry) in their vacuum flux exchange. And those are precisely the systems that are permitted to perform the five magic functions of great interest to the COP>1.0 energy researcher. Such a disequilibrium system can permissibly (i) self-order, (ii) self-rotate or self-oscillate, (iii) output more energy than the operator inputs (the excess energy is freely received from the active environment), (iv) power itself and its load simultaneously (all the energy is freely received from the active environment), and (v) exhibit negentropy. *Every charge and dipole in the universe already performs all five magic functions.*



It is **the purpose** of this book to clearly show that all EM systems are already powered by vacuum energy, and always have been. We cite the references and experimental proof that this is true, and the interested reader can check the extensive references himself or herself. The intent is to show that only a part of what has been discovered and is already known in particle physics is presently included in the woefully inadequate and ancient electrical power-engineering model. And frankly, unless there is a groundswell from the bottom of the scientific community, the leadership of the scientific community has no intention whatsoever of funding or allowing significant research in extracting copious EM energy from the vacuum (very simple) and learning to use it effectively (more difficult). A single 200 million dollars of good research in EM energy from the vacuum would solve the energy crisis forever, and dramatically reduce the pollution of the biosphere. The scientific community will spend many times that amount on their favored "big science" projects, but not one cent on EM energy systems powered by energy extracted from the vacuum.

Also, we show a sampling of the present work ongoing in inertial propulsion and antigravity research. Working with Sweet, in the 1980s I designed and Sweet performed a highly successful antigravity experiment.<sup>4</sup> I share with the reader the concepts and theoretical basis for that experiment, why it worked and how it worked, and the excellent results achieved. One of the tragic losses to science was the loss of the Sweet COP $\gg$ 1.0 vacuum triode amplifier (VTA) system with the death of Floyd Sweet. Nonetheless, we apply the mechanism we conceived so long ago to propose a mechanism generating the antigravity recently confirmed to be accelerating the expansion of the universe. We offer the long-neglected, Lorentz-discarded giant nondiverged Heaviside energy flow component accompanying every field-charge interaction as the probable generatrix of the excess gravity holding the arms of the spiral galaxies together. And we offer that same component — when connected with a flow of *negative* EM energy and with *negative energy* EM fields and potentials — as the specific generatrix of the excess antigravity that is accelerating the expansion of the universe. Both theses are testable on the laboratory bench.

Our target audience is several fold. Even though presented conceptually, the material is not oversimplified, and it is targeted at (i) the sharp young grad students and post-docs interested in extended (higher group internal

<sup>4</sup> Floyd Sweet and T. E. Bearden, "Utilizing Scalar Electromagnetics to Tap Vacuum Energy," *Proc 26th Intersoc. Energy Conversion Eng. Conf. (IECEC '91)*, Boston, Massachussets, 1991, p. 370-375.

symmetry) electrodynamics and in researching and developing COP>1.0 electrical power systems, (ii) the forward-looking electrical engineering professors who will at least consider that extended electrodynamic models and the laws of nature do permit COP>1.0 electrical power systems, and (iii) the still open-minded leaders of the scientific community, such as the National Academy of Sciences, National Science Foundation, the U.S. Department of Energy, the great national laboratories, etc. In *one area* of physics much better models of electrodynamics enabling COP>1.0 power systems, antigravity, and novel propulsion systems already exist (and a few such systems *experimentally* exist in the hands of independent inventors as well), while in a *second area* of physics that part of electrodynamics dealing with permissible COP>1.0 EM systems and unified field theory has been arbitrarily excluded at great cost to society, to the environment, and a tragedy to science and technology. Additional secondary targets are (iv) governmental leaders responsible for advanced research and development planning and funding, to argue that the "energy crisis" is a direct result of an inexplicable and sustained shortfall in the scientific mindset, and not as a result of the laws of nature and the need for cheap oil, coal, and gas or nuclear power plants, (v) science writers, journalists, and entrepreneurs to sensitize them to (hopefully) a coming energy revolution of unparalleled proportion, (vi) strategic and tactical planners in our Department of Defense to make them aware that the great logistics burden of modern highly maneuverable armed forces can and will be dramatically lowered by rapidly developing and using self-powering power systems "fueled" directly by the local active vacuum, and by adapting novel new propulsion methods, (vii) theoretical and experimental physicists to make them aware that the easiest thing in the world is to extract copious EM energy freely from the vacuum; just pay *once* to make a little dipole or assemble a charge and do not let it be destroyed, (viii) the Department of Energy upper level managers to bring into their awareness the coming advent of (and terrible need for) self-powering decentralized EM power systems worldwide, and the pressing need for a major role to be played by the DoE, (ix) the struggling but serious COP>1.0 researchers and inventors, to give them a technical overview — rather than just anecdotal material — of much of what has been done, tried, and conceived, and what seems to be successful and what is still to be determined, (x) the environmentalists devoted to cleaning up the biosphere and saving this precious planet, to make them aware that the answer to the world's energy problems and saving the biosphere cannot come to them from their conventional scientific consultants, who are trained in applying the very scientific disciplines responsible for the problem in the first place,

and (xi) **the long suffering undeveloped** and impoverished nations and peoples of the earth. Our fervent message is one of hope after all, *once a change occurs in the scientific mindset*. There is a cheaper, cleaner, and better way to get their economies and national infrastructures up and running, and it is imminently doable.

The main message of this book is that there is not now and there never has been an *electrical energy availability* problem. Every large centralized power generator actually outputs enough EM energy flow, extracted directly from the seething vacuum, to power all electrical loads on earth, if all the energy pouring from its terminals were caught and utilized. However, there is certainly an *EM energy flow interception* problem, to get more of the available energy flow from a source dipole intercepted and diverged into the circuit in a manner not complying with the Lorentz symmetrical regauging condition. Also, once the excess energy has entered the circuit and been collected, there certainly is a problem in *using the intercepted and collected energy in the circuit without destroying that part of the generator or battery — the source dipole — that is actually extracting all the energy from the vacuum*. Or at least to use the circuit's collected energy in such fashion as to destroy the source dipole in the generator *slower* than the energy is used to power the external load.

That conglomerate of the two sub problems — the "energy flow *interception, collection, and usage* problem — is the single energy problem. There is no other energy problem, and there has never been any other. One finds it very ironic that, in the conventional agencies, universities, the DoE, the National Science Foundation, the National Academy of Sciences, the national laboratories, etc., not one of them is working on the real, solitary electrical energy problem, even though they are importantly spending billions of dollars purporting to do so.

We fervently hope that the content of the book will reach a sufficiently interested audience to begin to change that century-old erroneous scientific mindset. We hope that the book, along with the important contributions of other COP>1.0 inventors and researchers having success, will spark a new creative drive in the scientific spirit that solves the problem of cheap, clean energy in three years or less. This is a doable. I firmly believe in the scientific method and what it can do once it is unleashed from the century-old dogma that COP>1.0 systems are against the laws of nature, physics, and thermodynamics. Just turn the young scientific and engineering tigers loose on the problem, give them some funding, and watch them do it.

As we stated in a formal rebuttal to a charge of perpetual motion nonsense, it only takes one white crow to prove that not all crows are black. And with respect to COP>1.0 EM systems far from thermodynamic equilibrium with their active environment, every charge and dipole in the universe is already a "white crow" pouring out EM energy freely and continuously with the speed of light, and exhibiting COP =  $\infty$ . This is in fact reluctantly recognized in physics, but it has essentially been buried from the attention and knowledge of generations of electrical engineers and most physicists.

A COP>1.0 experiment well known to nonlinear optics is the Bohren-type experiment, demonstrating the known negative resonance absorption of the medium. A typical experiment of that type outputs some 18 times as much EM energy as the experimenter inputs by standard calculations. We note that a single replicable experiment can and does negate any theoretical model that contradicts it. Hundreds of such materials experiments proving the feasibility of COP>1.0 EM systems are performed every year in any major nonlinear optics laboratory without a second thought. Together with the known but avoided source charge problem and proven broken symmetry of any dipolarity, it is almost unthinkable that our electrical engineering departments still do not incorporate the active vacuum exchange — and every EM circuit's broken symmetry in it — into the classical electrodynamic model used. In short, to really understand what powers every EM circuit, just now the electrical engineer would have to go across campus to the particle physics department and investigate broken symmetry of opposite charges — as are on the ends of the source dipole, once created in the generator or the battery, or as are involved with the single "isolated charge" considered with its associated virtual charges of opposite sign.

It is high time that our electrical power engineers and scientists heed the message of all these demonstrated white crows of nature, and begin developing and deploying self-powering COP>1.0 electrical power systems with alacrity.

We have a biosphere, a planet, a strong world economy, and an uplifting for the long downtrodden poor people of the world to recover. We strongly urge the scientific community to accept the challenge and meet it head-on.

Tom Bearden

22 July 2002.

# Chapter 1

## Foundations and Scientific Mindset

*"...the scientist makes use of a whole arsenal of concepts which he imbibed practically with his mother's milk; and seldom if ever is he aware of the eternally problematic character of his concepts. He uses this conceptual material, or, speaking more exactly, these conceptual tools of thought, as something obviously, immutably given; something having an objective value of truth which is hardly even, and in any case not seriously, to be doubted. ...in the interests of science it is necessary over and over again to engage in the critique of these fundamental concepts, in order that we may not unconsciously be ruled by them." [Albert Einstein]{1}*

### 1.1 Introduction

Einstein's quote is a beautiful statement that scientists should never take the present understanding — and the present models — as absolute. That is the approach the present author has taken for some 30 years, in a struggle to comprehend that class of electromagnetic (EM) systems that are open systems in disequilibrium in their *virtual photon energy exchange* with the active vacuum, and exhibiting a broken symmetry in that exchange. The statement beautifully expresses that the major problems encountered in grappling with such EM systems have been the existing errors and non-sequiturs in classical electrodynamics and other parts of physics. Many difficulties have resulted from the continued propagation of a 137-year old classical electrodynamics model formed before electrons, atoms, nuclei, positrons, the active vacuum, special and general relativity, quantum mechanics, etc. were discovered or known.

#### 1.1.1 EM Foundations Are Incomplete and Contain Errors

In any model, there are many assumptions. Even when a model is well-fitted and well-developed, it still applies only when the foundations assumptions on which it is based are true or are not too much in error. Whenever one or more of the fundamental assumptions is violated by phenomena uncovered, then there is a new class of phenomena where the model does not hold, or does not hold well and is only an approximation at

best. In that case, either the existing unsatisfactory model must be improved and advanced, or a new model must be constructed.

Great scientific minds continue to point out Einstein's beautiful principle in different words. E.g., expressing the thought of Stephen Hawking, one of the great physicists of our day:

*"All we ever know is our models, but never the reality that may or may not exist behind the models and casts its shadow upon us who are embedded inside it. We imagine and intuit, then point the finger and wait to see which suspect for truth turns and runs. Our models may get closer and closer, but we will never reach direct perception of reality's thing-in-itself." [As stated by George Zebrowski] {2}.*

Excellent scientists — Feynman, Wheeler, Bunge, Evans, Barrett, and many others — have indeed pointed out that classical EM theory is seriously flawed. In the words of Bunge {3}:

*"...it is not usually acknowledged that electrodynamics, both classical and quantal, are in a sad state."*

The author also found it imperative to return to many of the original seminal papers of physics, particularly in electrodynamics. The major concepts in those papers led to the present classical EM model. This was particularly true of the work of Poynting {4a, 4b} and Heaviside {5a-5c}, who independently and simultaneously arrived at the notion of the flow of EM energy through space<sup>5</sup>. Their work occurred in the 1880s, after Maxwell was already deceased. It also necessitated reviewing Lorentz symmetrical regauging of the Maxwell-Heaviside equations, where Lorentz arbitrarily discarded all permissible COP>1.0 Maxwellian systems.

The science of this "EM energy flow through space" is controversial to this day. Which is the real "EM energy flow vector" as such has never been

---

<sup>5</sup> As we shall point out later, the concept of energy flowing through 3-space is a non sequitur and requires substantial revision today, to be consistent with the nature of observation and the fact that no observable continuously persists. Any observation is an instantaneous frozen 3-space "snapshot" at a single instant, gone the next instant when almost immediately replaced by another such frozen snapshot. In between observations, not mass but *masstime* exists. The same is true for 3-space, which only exists as the output of an observation process. Prior to observation, *spacetime* exists.

adequately resolved, and there continue to be polite debates about it {6}. One should also be aware that physicists really do not know what many things — including energy — *are*. The definitions of these fundamentals are still uncertain, as stated rather poignantly by Feynman {7} in this quote:

*"It is important to realize that in physics today, we have no knowledge of what energy is."*

As another fundamental example, Feynman {8} also pointed out that we really do not know what *force* is<sup>6</sup> either! Quoting:

*"One of the most important characteristics of force is that it has a material origin, and this is not just a definition. ... If you insist upon a precise definition of force, you will never get it!"*

### 1.1.2 Physics Is Not the Mathematics, But What It Manipulates

Following Feynman's ansatz, one should realize that the physics is not really in the mathematics itself, but in the physical meaning of the concepts that the mathematics manipulates. Here again, the inimitable Feynman {9} cautioned against over-attachment to the mathematics itself. He said it very clearly:

*"Mathematicians or people who have very mathematical minds, are often led astray when "studying" physics because they lose sight of the physics. They say: "Look, these differential equations – the Maxwell equations – are all there is to electrodynamics it is admitted by the physicists that there is nothing which is not contained in the equations. The equations are complicated, but after all they are only mathematical equations and if I understand them mathematically inside out, I will*

---

<sup>6</sup> The problem is the ubiquitous and erroneous use of a "separate" force acting on a "separate" mass. Actually mass is a *component* of force, as can be seen from  $F \sum d/dt(mv)$ . Hence there is no such thing as a separate force in empty space, acting upon a mass. Instead, the massless 4-field in space acts upon mass to produce force *in that interaction*. Force is not a cause, but an effect of an ongoing interaction — as is any observable. An observable is a continuing series of frozen 3-space LLL snapshot entities given by the result of continual application of  $\epsilon/\epsilon t$  (LLLT) ♥ LLL by photon emission. The formation of the LLLT (spacetime and masstime) in between observed  $m$  as LLL, is produced by photon absorption of the previous  $m = \epsilon/\epsilon t$  (LLLT).

*understand the physics inside out." Only it doesn't work that way. Mathematicians who study physics with that point of view – and there have been many of them – usually make little contribution to physics and, in fact, little to mathematics. They fail because the actual physical situations in the real world are so complicated that it is necessary to have a much broader understanding of the equations."*

Such matters and similar thoughts had bothered me even back in the early 1950s, when I could not find a single professor or dictionary of physics that *logically* defined a field or a potential. Considered rigorously, the definitions all fell apart and violated elementary logic. Improper, insufficient, or just plain *wrong* definitions in physics have continued and are still widespread to this day. To give a single example from an excellent book by Kraus {10}: On p. 60, Kraus gives the formula for a potential referred to as the "absolute potential" of a charge source. Quoting:

*"This potential... is, by definition, the work per coulomb required to bring a positive test charge from infinity to the point  $r_1$ ."*

Kraus erroneously "defines" the scalar potential identically as work, which is equating the cause with the effect. The work that dissipating a potential does or can do, is not the potential itself! Else "human" means nothing but how well one can chew one's food or drive an automobile. Actually, Kraus gives one theoretical way to measure or calculate the effect of the potential's *local intensity at a point*.<sup>7</sup> Note that what is measured is the energy *diverted from* the potential at that point, around that test charge. This does not specify the *entity* (the potential itself) at all, but only what has been diverted from it. It is rather like confusing the whirlpool (water diverted from the normal river flow) in a river as being the river itself.

---

<sup>7</sup> To show the non sequitur, a million more positive test point charges could be brought from infinity to that same point, and the potential — without any change in it — would cause the same amount of work to be done upon each of those charges. As can be seen, even noted professors can speak rather casually when they "define" the potential's point intensity as "the" potential (which extends over all space, not just at that one point). There may be different intensities at different points in the potential, but the potential itself remains one-and-the-same thing regardless of which one or all of the point intensities are discussed. And neither the point intensity of the potential nor the potential is the work that is done upon a moving charge by that potential or its intensity.



Integrating what has been diverted from it does not yield the potential itself! At best, the measurement gives an indication of the *intensity* of the potential at a point, insofar as its reaction with charge is concerned. More rigorously, what is being utilized is the potential's reaction cross section presented to a *unit point static charge* at that point. The same unit point charge, if placed in particle resonance, will sweep out more geometrical area and exhibit a greater reaction cross section. That will increase the energy collected divergence of the energy flow that is being moved around the particle itself. By normal calculations, the resonant charge may collect some 18 times as much energy as is possible at the same point by the same charge in static mode — e.g., as shown by Bohren {24, 25}.

A definition must present an identity. Examining the proposed definition as "the potential is identically ... work" one sees the problem immediately. *The potential exists whether or not there is a positive test charge, or whether one moves such a charge in from infinity or not, and whether there is any work done or not.* None of that is what a potential *identically is*, but only one aspect of what it *does* or *can do* or *can cause*. One leaves as an exercise for the reader the task of further examining dictionaries of physics and textbooks, to try to find a satisfactory definition of that common scalar potential.<sup>8</sup> We do not believe the reader will find it.

Yet any good textbook will also contain some real gems of great insight, simply said. As an example from Serway {11}, we eventually took a most marvelous cue, of how to get around classical thermodynamics' prohibition against heat energy "running uphill" from hot to cold. In an insightful statement, Serway said {11}:

*"The second law [of thermodynamics] does not rule out the possibility of pushing heat uphill, as it were, from a cold object to a hot one, or of creating order out of*

---

<sup>8</sup> The scalar potential identically is actually a harmonic set of phase conjugate longitudinal EM wavepairs, as shown by E. T. Whittaker in 1903 {85}. Even Whittaker, however, misinterpreted his wavepairs only after interaction with that ubiquitous unit point charge assumed at every point in space. He gave two *effects* of that interaction, not the *cause* (which exists prior to interaction) *and the effect* (which exists only after interaction). Reinterpreting to get at the causal wave, each wavepair is a matched set of two waves; an incoming EM longitudinal wave in the time domain prior to interaction with a charge, and — after the time-energy wave is absorbed by the charge, an emitted outgoing EM longitudinal EM wave in 3-space. The so-called "static" potential is not static at all, but is a dynamic, ongoing 4-space process. This follows the re-interpretation by the present author {12} of Whittaker's decomposition — a re-interpretation then found to be consistent with quantum field theory {19} and with broken symmetry of opposite charges in particle physics {73}.

*disorder. It merely states that such a reversal of the natural flow requires an influx of energy... "*

This essentially states the *law of entropy*, where to reverse entropy (disorder), one must apply ordering (energy).<sup>9</sup> We also note that the original concept of entropy was as *dissipation of potential*. There are of course different ways to apply the energy, and it need not be by the operator himself. Chapters 4, 5, 6, 7, and 8 of the present book give some unusual ways. A special paper {12} published by the author in 2000 gives another. Indeed, when the flow of time is predominantly reversed, so is the "entropy" of a situation, since the "videotape is running backward", so to speak. In that case, the entire classical thermodynamics must be extended to essentially include its own opposite. The making of a small time-reversal zone where such things happen is as simple as involving a predominance of antiphoton interactions with the charged particles in that zone, rather than a predominance of photon interactions. What we are saying is that the notion of irreversibility in thermodynamics is not necessarily absolute. It usually assumes a "time forward" situation, and may not hold in a "time-reversed" situation. In our chapter on cold fusion, we will present some specific and quite startling nuclear interactions that occur as a result of the time reversal of the coulomb barrier (repulsion of

---

<sup>9</sup> Now notice what Serway's statement means with respect to the classical thermodynamics "definition" of closed system. Thermodynamics defines a *closed system* as one in which mass is not exchanged across its boundary, but energy can be. That definition permits a closed system to receive excess energy from its active environment, and thereby reduce its entropy. A specific example is simply potentializing a circuit, prior to movement of the current. Hence the entropy of a closed system does not necessarily increase, but may decrease or increase if the system is in disequilibrium (difference in energy received from its active environment and energy escaping back to the active environment from the system. For the same system, if energy exchanges across its boundary equally in both directions, the system is said to be in "equilibrium" with respect to external energy exchange. One must be very careful in interpretation of the second law of thermodynamics! One has a very different "closed thermodynamic system" when it is in *energy exchange disequilibrium*, than when it is in *energy exchange equilibrium*. Equilibrium is the condition of maximum entropy. For substantial disequilibrium condition, entropy cannot be computed, but is less than the entropy of the same system in equilibrium. The entire ansatz of thermodynamics may be violated once time-energy is transduced into internal EM energy inside the system. That is a fundamental disequilibrium, performed by every charge in the universe. Hence of necessity we have advanced and utilized new definitions of "open system" and "closed system" in our approach in this book, as discussed in the Appendix.

like charges in a forward time situation) into a coulomb attraction between like charges in a time-reversal zone and time-reversed situation.

If Serway's statement were reversed, it would then be a statement of the *law of negentropy*. It would state that self-ordering (i.e., freely receiving energy from the active environment) in a system could indeed "push heat uphill from a cold object to a hot one", and the system could simultaneously emit energy in the process. Every charge does it!

We did find it necessary to correct the classical thermodynamic definitions of "open system" and "closed system". To define a closed system as closed only to mass transfer, but open to energy transfer, is a gross non sequitur. Since general relativity was published in 1915, energy and mass are known to be the same thing (*mass is just a special form of energy*), hence the term "mass-energy" (mass as energy) in physics. Whenever energy crosses the boundary of a system, the system's mass changes and mass (or certainly mass change) has also crossed that boundary. Indeed, as we shall point out, in 1917 Hilbert specifically pointed out that in general relativity there can be no energy conservation equations of the kind usually employed elsewhere. The fact that general relativity falsifies much of the present foundations of classical thermodynamics seems to have been either ignored or missed by most of the scientific community, although we will quote leading Russian scientists who have noticed it and are aware of it.

The reader is thus warned that, henceforth, when we use "open system" we mean one where either energy or mass or both exchanges across the system boundary. When we use "closed system" we mean one in which *neither* energy nor mass exchanges across the boundary. In short, the notion of a "closed system" has been redefined into what classical thermodynamics calls an "isolated system". We already know from particle physics and the active vacuum (and from general relativity and the change of spacetime curvature with every change of spatial energy or mass-energy), and from the giant negentropy involving time energy transduced into 3-space energy and vice versa, that there is no such thing in all the universe as a truly closed system.

In Appendix A, we have discussed how extension and change to classical thermodynamics must be made. We do this by extending the first law, refuting any absoluteness of the second law and third law, dealing with the zeroth law in a new way, etc. We also urge the better theoreticians to re-examine classical thermodynamics along such lines, to modernize and upgrade it. We believe that the present scientific work to extend

thermodynamics so it fits those situations now known to violate it should include additional considerations such as we present in Appendix A.

In short, with the new definitions Serway clearly states the difference between classical equilibrium thermodynamics, where no excess energy from the environment is received, and the thermodynamics of systems far from equilibrium with their active environment (using the new definition of open system for clarity), in which case excess net energy from the environment can be received and used in electromagnetic systems, providing  $COP > 1.0$  systems or even  $COP = \leftarrow$  systems. The windmill, sailboat, and waterwheel are age-old examples of disequilibrium systems where of course the energy of mass in motion is what is transduced. It is our objective in this book to point out the use of electromagnetic systems in energetic disequilibrium with their active environment (the active vacuum and curved spacetime) to provide just such negentropy.

### 1.1.3 Time Is Energy and Must Be Considered As Such

In a physics model, one's choice of fundamental units is arbitrary.<sup>10</sup> As an example, in one type of physics only a single fundamental unit — length — is employed. All other entities then become functions of length.

We are also free to choose the *joule* as the single fundamental unit in our physics model. The result that mass is a function of energy is now familiar and quite accepted, by the famous formula  $E = mc^2$ . Indeed, as can be seen, in that equation mass and energy are one and the same thing, since  $c^2$  is a dimensionless constant. However, in our new model time becomes a function of energy similarly, and thus time is identically energy.

Let us perform a thought experiment. Suppose we take some spatial EM energy in 3-space, and compress it by the factor  $c^2$ . What can we do with it? If we leave it there in 3-space, it is known as "mass". If we place it on the fourth Minkowski axis  $ict$ , it is known as time because  $t$  is the only variable on that axis, and the only "place we can set it".

So to first order, *time has the same energy density as mass*. Multiplying an amount of time  $t$  (in seconds) by  $c^2$  gives the decompressed spatial energy  $E$  that the time  $t$  will transduce into. In short,  $E = tc^2$  also.

Now we notice what special relativity has to say about the relationship between time-energy and mass-energy. When the mass-energy increases

---

<sup>10</sup> E.g., see Jackson, *Classical Electrodynamics*, 2nd Edition, Wiley, 1975, p. 811-812; *ibid.*, 3rd Edition, 1998, p. 775. Jackson wryly remarks on how much excess heat and passion have been unnecessarily expended on that subject.

(e.g., as a function of velocity), time "dilates" or "decreases". In other words (hint), there is a sort of special new extension to the conservation of energy law: If mass (3-space) gains some 3-spatial energy, then time loses some time-energy. Since time is spatial EM energy compacted by  $c^2$ , then *the relativistic energy changes in the time domain are enormously greater than the corresponding relativistic changes in spatial energy in the photon*. To the external 3-space observer, this is the injection of negentropy with respect to the present 3-spatial conservation of energy law. In the reverse case (as when the object reduces its velocity), if mass (3-space) loses some energy, then time gains some time because the time dilation reduces — i.e., time contracts or densifies (less time has more energy). To the observer, this is the production of entropy with regard to 3-space energy conservation. Yet the observer misses the fact that, accompanying entropy in 3-space is negentropy in time energy on the 4th Minkowski axis, and vice versa.

We believe this to be a rather dramatic extension to the previous concept of entropy in thermodynamics. We get 3-space entropy in physical processes only by gaining 4th dimensional negentropy accordingly. One can thus appreciate the impact upon the entire subject of thermodynamics, once time-energy is accounted and the new interplay of entropy and negentropy are accounted. We believe that this mechanism may involve the fundamental mechanism for both entropy and negentropy. Neither is produced alone; both are always produced in tandem. This of course is not what we "observe" since all observation is 3-spatial. Hence to observe the system and see 3-space entropy or negentropy is to hide the simultaneous 4th dimensional negentropy or entropy that unobservably accompanied the observable that we did see.

Again we call attention to the original meaning of entropy: the dissipation of potential (i.e., potential energy).

Once we understand that *time* is a special form of energy (we discuss this shortly), we may input the energy required to "move heat energy backwards" — i.e., we may directly engineer negentropy — by transducing some time-energy into 3-spatial energy. We can do it easily by time reversal, and every charge in the universe does it already. On the other hand, we can do it by breaking the symmetry of time-energy flow — which is as simple as forming a little dipole. The broken symmetry of unlike charges — and therefore the dipole — was discovered by Lee and Yang {13a-13c}, who strongly predicted it in 1956. Wu *et al.* {14} confirmed it experimentally in early 1957. This was such a revolutionary

change to physics that Lee and Yang were awarded the Nobel Prize in the same year, 1957 — an almost unprecedented action.

Its broken symmetry tells us that the dipole's unlike charges continuously absorb virtual photon energy from the active vacuum, transduce it into real observable energy, and pour out real, observable EM energy in all directions in 3-space. That puts an entirely different perspective on *what really powers every dipolar EM circuit; i.e., what produces the flow of energy pouring from the terminals of every generator and battery, filling all space around the external circuit and its conductors*. The EM energy pouring from the generator or the battery is not due to the generator outputting some of its own available internal energy (from the shaft energy input to the generator, transduced into magnetic field energy inside the generator, and then dissipated to separate the charges and form the source dipole between the generator terminals) or the battery transducing and outputting some of its available chemical energy (which is only dissipated inside the battery to separate the internal charges and form the source dipole between the battery terminals). We will explain that later, and explain how any dipole or charge simply pours out real, observable energy continuously in all directions, without any *observable* input of energy. The input energy is there, but it is in *unobservable* (virtual) form.

In 1971 while a graduate student at the Georgia Institute of Technology, I realized the mechanism that generates the "passage of time" insofar as the observer is concerned {15}. With a little more work, this gave the clue in the 1990s for the mechanism generating little momentary *time-reversal zones* (TRZs) {16} in the electrolyte utilized in cold fusion experiments. Hence we proposed the use of little time-reversal zones forming momentarily in the electrolyte after loading of the palladium lattice of the electrodes with hydrogen or deuterium. Such time-reversal zones can form in the region of excessive positive charge accumulation, since positive charge can be said to receive negative EM energy from the time domain and output negative EM energy in 3-space.

This led to uncovering an entire class of new nuclear reactions — fusion reactions at low spatial energy but high temporal energy — in these little temporary time-reversal zones (TRZs), in which like charges attract and unlike charges repel {17}, followed by rapid decay of the TRZs where the normal law of attraction and repulsion is restored again.

In theory, a fermion cannot be time-reversed because the Pauli exclusion principle prohibits it. However, a boson can be time-reversed, so fermions can be time-reversed in pairs, where each pair acts as a *quasi*-boson. The

TRZ completely overcomes and *reverses* the "coulomb barrier" between a pair of like fermion charges.<sup>11</sup>

As an example, two deuterium ions in a little TRZ would momentarily form a quasi-nucleus of helium, since the two positive deuterons are attracted so closely that each enters the strong force region of the other. At the same time, the strong force is weakened by the partial time reversal of the gluon forces, so that the quarks are nearly freed. As the other ions in the surrounding solution then move to destroy the momentary time-reversal zone, their movement forces the TRZ to decay back to a time-forward zone — with the decay action starting from every point in spacetime inside the nucleons themselves<sup>12</sup>. The TRZ decay-induced action thus strikes the *nearly freed* quarks first, and decay can occur by easy quark flipping while the gluon forces are still much reduced and not back to normal strength. Hence as the gluon forces return toward normal, the quasi-nucleus decays by the strong force increasing and overpowering and drawing the quasi-nucleus into a full-blown helium ion — i.e., an alpha particle — flipping the partially-freed quarks as necessary to do so (that is not necessary in equation [1] below).

During decay of the TRZ, the weakened strong force grows much more rapidly than the Coulomb force zeroes and then increases. Consequently, the quasi-nucleus of two D+ ions merely draws together due to the rapidly increasing strong force, forming an alpha particle without quark flipping. Four H+ ions — four protons — in a quasi-nucleus in a TRZ will undergo quark flipping twice when the TRZ decays, thereby resulting in an alpha particle.). So that explained the anomalous formation of the alpha particles in the experiments. The interaction for two ions of deuterium is given by:

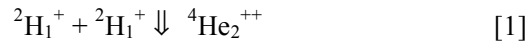

---

<sup>11</sup> In a TRZ, the law of attraction and repulsion of charged particles is reversed.

<sup>12</sup> Any moment in time exists everywhere simultaneously throughout the universe. In short, time is a multiple connection in 3-space. Hence in any time-reversal zone (a TRZ) where time is reversed, then starts fading away and back to a time-forward zone (TRZ), the changes induced by the "fading back to TFZ" *simultaneously* involve every point in the 3-space of that TRZ that is changing (decaying). An easy change is quark flipping, since the quarks are almost freed in the TRZ to begin with. The reason the reaction proceeds in that direction is that the recovery of the strong force is much faster than the restoring of normal electrical repulsion, hence the quasi-nucleus is drawn further together into a full nucleus, constituting a legitimate nuclear transmutation at low spatial energy but high time-energy.

This interaction between two deuterons in solution does not occur in a normal time-forward zone because of the coulomb barrier preventing the two deuterons from entering each other's strong force region and acting as a quasi-nucleus of helium, so particle physicists have missed it. It does exist in a time-reversal zone; such zones form and then decay back into normal time-forward zones. This is possible because the coulomb barrier is momentarily reversed. The use of such TRZs in particle physics opens up thousands of new nuclear reactions, all at low *3-spatial* energy, but involving very high *time-energy*. Because of the extreme energy density of time, *these time-energy-induced reactions are actually much higher-energy reactions than high-energy physicists presently consider and utilize!* Indeed, it opens up a new kind of far more energetic "high energy physics".

Cold fusion experimenters have unwittingly opened a window upon a vast new particle physics, previously overlooked by our scientists because they have disregarded the use of time-energy, time reversal zones, and transmutation of time-energy into 3-spatial energy in their nuclear reactions. However, a few physical theorists attempting to better explain particle physics have recognized the importance of the time domain, and probing work in that respect is occasionally done {18}. In our view, it is not accidental that more than 600 successful cold fusion experiments have been obtained, by a variety of researchers in many labs in several nations. We strongly suggest that much of the conventional physics community has firmly placed its collective head in the sand, and is refusing to grapple with the startling new time-energy physics that is being initiated by cold fusion research.

In 1999 (published in 2000) {12} we finally discovered a great new symmetry in EM energy flow, whereby time-energy flow symmetry and 3-space energy flow symmetry are each individually broken, while an overlooked and more fundamental 4-symmetry energy flow — between the time-domain and 3-space — is sustained. *The result is that all EM energy in 3-space comes from the time domain locally and returns to the time domain locally, in a giant negentropic circulation.*<sup>13</sup> Together by the

---

<sup>13</sup> This is also understandable from the implications of the observation process, which yields a frozen 3-space snapshot existing only at a single instant. Thus any 3-space energy existing there in that frozen instant, had to just come from 4-space (from the time-domain via the giant negentropy process, if we take the view that "the past exists only in time itself"). For the frozen snapshot to "change", time must be added to it, which converts it to a 4-space process again. So the "3-spatial" observed



discovery of relevant quantum field theory work by Mandl and Shaw {19}, this now lends strong support to the use of time-energy in physics as a practical matter for strenuous investigation.

As an example, Mandl and Shaw {19} treat the four polarizations of the photon. Neither the longitudinal nor the scalar photon is directly observable, but in the presence of charge the two are observable in combination, where they manifest as the "instantaneous" Coulomb (i.e., electrostatic) potential. This argument, translated from particle terminology to wave terminology, directly fits our re-interpretation {12} of Whittaker's 1903 decomposition of the scalar potential {85}. For the combining mechanism of the fields of the photons, we must account for *the field as a ubiquitously assumed interaction with the detecting/observing unit point charge*. Thus we must account for the absorption of the incoming time-polarized wave or photon, the transduction of that excitation energy of the charge into longitudinal EM wave/photon energy, and subsequent emission of that excitation energy in 3-space. That is what happens for a negative charge. For the positive charge, the process is time-reversed, hence occurs in opposite fashion. Or as an alternative, the positive charge can be said to continuously receive negative time-energy from the time domain and emit negative spatial EM energy.<sup>14</sup>

There is an *energy polarization transduction function* of charge, whereby it transforms received time-polarized photon energy into emitted longitudinal photon energy in 3-space (for the negative charge, and vice versa, for a time-reversed positive charge). This transduction appears to have been overlooked in physics prior to our recognition of it. It can in fact be used to generate an acceptable definition of charge itself. Charge is the

---

energy must come from an immediately previous 4-space process, and must return to an immediately following 4-space process.

<sup>14</sup> As we will find in our chapter on antigravity, there is good reason to treat the positive charge as a source of negative energy and negative energy fields. However, this is pertinent only prior to observation of the charge, while it is still a 4-spatial unobserved negative energy electron entity. For the observable charge, one has already conjugated — after all, the positron is observed as if it were an electron going backwards in time, which we observe as an electron with its charge reversed and with parity reversal (of its spatial direction). For the observable charge, we have already reversed the negative energy fields into positive energy fields by simply reversing their direction and the time associated with the photon (quantum of the EM field).

continuously active entity which performs that ongoing process or those ongoing processes of energy transduction between the time domain and 3-space (between the causal unobserved 4-space process and the observed 3-space snapshot). Or in other words, it is an active process connecting 4-space cause and 3-space effect, and connecting the unobserved (such as virtual) to the observed (such as mass).

So for a dipole, the "causal" time-polarized EM wave or photon as a 4-space entity comes to the dipole<sup>15</sup> (3-spatial as observed) and is absorbed by the detecting negative charge or dipole, then is re-emitted as the longitudinally polarized EM wave or photon in 3-space. *That absorption and remission is what charge does, since it is an entity for performing that process.* The emitted energy in turn is absorbed by the nearby positive charge, retransduced into time-energy, and re-emitted back to the time domain. This ongoing very special 4-space energy circulation (even with a virtual charge in the vacuum) is what a scalar potential *identically is and is doing*, at every spatial point of itself, inducing vacuum polarization and "point dipoles" in the virtual state in the process. Recognition of these missing functions allowed at last a solution to the long-vexing problem of the source charge and its associated fields and their energy, often called the most difficult problem in both quantum and classical electrodynamics {68}. We discuss that solution later.

#### 1.1.4 The Search for COP>1.0 Circuits and Systems

A very long search and much intense study and reflection eventually revealed the concepts and principles of those long-neglected disequilibrium Maxwellian systems that permissibly output more energy than the operator inputs. The active environment — not the operator — simply inputs the rest of the energy. Such disequilibrium systems are indeed permitted in Maxwell's theory {20}, and are also still prescribed by Heaviside's severe curtailment of it {21} into what is two vector equations with variables unseparated, rather than Maxwell's 20 equations in 20 variables.

---

<sup>15</sup> Prior to interaction of the incoming time-energy with the observable charge or dipole, it interacts with the virtual particles of the vacuum, generating vacuum polarization. Neither the virtual particles nor the time-energy are observable; only the effects of their conglomerate interactions with observable charges are observed. Hence one can take the particle view that virtual particle energy is continually absorbed, or one can also take a quantum field theory view that time-energy is continually absorbed. The two are always present in combination.

When Lorentz<sup>16</sup> symmetrically regauged the Maxwell-Heaviside equations, he arbitrarily discarded the entire class of Maxwellian systems that are far from equilibrium in their exchange with their active (vacuum) environment. Lorentz revised (symmetrically regauged) the Maxwell-Heaviside equations to make them amenable to separation of variables and closed analytical solutions, thus reducing the onerous chore of numerical methods. This Lorentz symmetrical regauging is given in most EM textbooks {22}, and we show it in Chapter 2. The symmetrically regauged Lorentz equations are not Maxwell's equations, nor are they the truncation of Maxwell's theory by Heaviside *et al.* Considering an active environment, under our altered thermodynamics definitions Lorentz implicitly selected and retained only the equilibrium class of Maxwellian systems, while *arbitrarily discarding* the entire disequilibrium class. He thus discarded all those Maxwellian systems permitted to produce COP lying in the range  $1.0 < \text{COP} \Omega \leftarrow$ .

Maxwell's electrodynamics is a *material fluid flow theory* and it assumes a material ether. Anything that fluid systems can do, electrodynamics systems can do, at least in theory, because their mathematical models are the same form. So when one cites known examples of fluid-driven physical systems where the energy to run the system is freely furnished by the active environment, analogous electrodynamic systems in active environments — and in disequilibrium exchange with that environment — must also exist in nature. Indeed, particle physics requires it and proves it. These are the very systems arbitrarily discarded by Lorentz symmetrical regauging in every university.

So there exists a direct analogy between fluid systems and classical electromagnetic systems. The common windmill, waterwheel, and sailboat demonstrate by analogy that open EM systems far from equilibrium — powered by free EM "winds" and "energy flows" in the active vacuum environment — also exist in consonance with natural law. They are no more mysterious than a solar cell power system, which is after all a recognized "free energy" or "overunity" system, as is the humble charge (thought to be the source of all EM energy, fields, and potentials). In physics, the powering of systems by receipt and use of energy from their

---

<sup>16</sup> Actually first accomplished by Ludwig Valentin Lorenz in 1867, then by H. A. Lorentz much later. Lorentz was given the credit erroneously. Lorenz actually derived electromagnetic theory independently in his paper. See J. D. Jackson and L. B. Okun, "Historical roots of gauge invariance," *Rev. Mod. Phys.*, Vol. 73, July 2001, p. 663-680.

active environment leads directly to the thermodynamics of systems far from thermodynamic equilibrium in their energetic exchange with that active environment.

It follows that the seeming absence of such *electrodynamic* systems arises not because they are impossible but because present-day circuits and systems are ubiquitously designed to self-enforce an inherent energy equilibrium with their active vacuum environment. The closed-current loop circuit turned out to be the Lorentz self-regauging demon involved in destroying the COP>1.0 capabilities of every EM circuit. So little by little, we unraveled the long tedious trail of Maxwell's electrodynamics and what had happened to those missing Maxwellian-Heaviside systems far from equilibrium with the active vacuum.

We learned how, where, and by whom those permissible overunity Maxwellian systems were discarded. That is, we found what happened to all those Maxwellian *open disequilibrium systems* — originally included in Maxwell's and Heaviside's theories — where such a system receiving and using excess energy from its active environment<sup>17</sup> is permitted by the laws of physics, electrodynamics, and thermodynamics to:

---

<sup>17</sup> For the discerning reader, of necessity we have revised the foundations of the ancient classical thermodynamics, as further discussed in Appendix A. We refer the reader to Bimalendu N. Roy, *Fundamentals of Classical and Statistical Thermodynamics*, Wiley, New York, 2002, and to any good book on the history of thermodynamics. Also particularly good is Kondepudi and Prigogine, *Modern Thermodynamics: From Heat Engines to Dissipative Structures*, Wiley, Chichester, 1998, reprinted with corrections in 1999. The foundations of classical thermodynamics (and its fundamental definitions) were basically frozen prior to the advent of Maxwell's 1865 seminal theory, and well before the 1880s discovery (modeling) of the flow of EM force field energy through space. Some of the fundamental definitions of thermodynamics now will not withstand critical review in terms of "meshing" with the Heaviside/Poynting material fluid energy flow theory. Neither will they withstand the new concepts of energy such as mass-energy, time-energy and transduction between time-energy and spatial energy by every charge. E.g., thermodynamics defines an *open system* as one that exchanges energy and mass with its surroundings. Yet it defines a *closed system* as one closed only to mass exchange, not to energy exchange. *If the energy exchange is analogous to material energy flow and changes the mass of the system, then that definition of closed system is a non sequitur.* From general relativity, mass is simply energy anyway, and so "mass" exchanging across the boundary of the system is actually energy exchanging, and vice versa. Since Maxwell's theory is a *material fluid* theory, the Poynting and Heaviside energy flow models are *material fluid flow energy* models by analogy. The specialized thermodynamics definition of *closed system* rigorously will not logically allow the exchange of "material fluid energy flow" (or energy as matter)

since it prohibits matter flow, but the specialized definition of *open system* would and does. In short, with respect to material fluid energy flow, the concept of the “closed system” in thermodynamics has forced itself to become the *isolated system* instead, which is unacceptable since we must model EM energy flow exchange between the environment and the system. So we must change the thermodynamic definitions of *open system* and *closed system*. Else there cannot be any EM energy-mass or mass-energy flow between environment and system, which totally violates what is well known to be happening in all EM systems. In modern physics, every charge and every dipole already have such energy exchange with the active vacuum environment, and it is never zero; instead, it is of enormously high magnitude. Without that exchange, as we advance in this book, there cannot even be a “source charge” or associated EM fields and potentials and their energy, reaching across space. In other words, without it we can have no electrodynamics at all. So we have uncovered a fundamental and major contradiction between classical thermodynamics and general relativity, as well as between thermodynamics and the “material EM fluid energy flow” model used in electrodynamics. What classical thermodynamics calls a “closed system” permitting energy flow exchange, we must now logically regard as an *open system* because it is open to energy exchange across the boundary! The previous notion of the *isolated system* — with no exchange of either energy or mass — is what we must treat as a truly *closed system*. And there is none such in the universe, as we know in particle physics (e.g., because of the discovery of broken symmetry in 1957 and because of the well known active vacuum exchange with every EM charge and dipole). So we have corrected these direct contradictions between “EM as a material fluid energy flow theory” and the old classical thermodynamics.

As the reader will later see, this strongly affects our new definitions of *efficiency* and *coefficient of performance*. The new definitions we advance are rigorous, and they also apply to  $COP > 1.0$  EM systems, and even to self-powering ( $COP = \leftrightarrow$ ) EM systems. They also hold for very novel new energy processes such as quantum potential energy in a multiply connected space, multiple retroreflections and re-use of the same energy, conversion between time energy and spatial energy, and 4-space giant negentropy energy flow circulation.

But one can no longer be allowed to equate *efficiency* with *coefficient of performance*. Now they are never the same thing, just as a six-foot tall man and a six-foot tall doorway are never the same thing, even though they have the same height magnitude. We warn the reader that a great deal of thought and study must be put into appreciating these suddenly encountered changes to the quite old classical thermodynamics definitions. The changes are absolutely necessary. Bluntly put, in light of much more modern knowledge, a rigorous foundations analysis reveals the classical thermodynamics as well as disequilibrium thermodynamics to contain logical contradictions, such as its direct contradiction with general relativity and the EM material fluid energy flow theory. Either we give up or dramatically change the present EM energy flow theory, or we must make the necessary foundations changes to thermodynamics. We have chosen the latter option in this book, and the reader is forewarned of that dramatic change. The specific changes and rationale are discussed in Appendix A.

- (1) self-order,
- (2) self-oscillate or self-rotate,
- (3) output more energy than the operator inputs (the excess being freely received from the active environment),
- (4) power itself and its load simultaneously (all the energy being freely received from the active environment), and
- (5) exhibit negentropy.

We vigorously pursued those long-lost Maxwellian systems, and we eventually found them. We also found real experiments {23, 24, 25, 26, 27, 28} and real devices {29a, 30, 31, 32, 33, 34, 35a, 36a, 36b} that performed one or more of those fabulous five functions, though there was often no realization by the experimenters, inventors, and scientists of the actual mechanism involved. Eventually my colleagues and I were also able to produce a successful experimental device {37, 38a-38c, 39}, the motionless electromagnetic generator (MEG), which outputs more energy than we input to it. We cover the MEG in Chapter 7. Presently a cooperative research program is ongoing with the National Materials Science Laboratory of the National Academy of Sciences of a friendly foreign nation, to develop and market commercial power systems based on successful laboratory experiments with the MEG. At this writing, we are also strongly seeking the extensive funding required to set up a physics lab and complete the final research allowing production of power systems.

### 1.1.5 Additional Very Important Implications

We also formally proposed {40} that the vast nondiverged EM energy flow component — Heaviside's "dark" nondiverged energy flow component, accompanying every reaction of a charge with a field or a potential, but arbitrarily discarded by Lorentz and modern classical electrodynamicists — is the generatrix for the extra gravity holding the arms of the spiral galaxies together, after all the dark matter is accounted.<sup>18</sup>

---

<sup>18</sup> Heaviside himself recognized the gravitational implications of his extra component of energy flow, which is in closed circular loops. Beneath the floorboards of his little garret apartment, years after his death, handwritten papers were found where Heaviside used this component for a unified EM approach to gravitation. See E. R. Laithwaite, "Oliver Heaviside – establishment shaker," *Electrical Review*, 211(16), Nov. 12, 1982, p. 44-45. Laithwaite felt that Heaviside's postulation that a flux of gravitational energy combines with the ( $\mathbf{E}\Delta\mathbf{H}$ ) electromagnetic energy flux, could shake the foundations of physics. Quoting from Laithwaite: "*Heaviside had*

In addition, my close colleague Bedini and I have filed a patent application upon a very special process to "freeze-frame and lock-in" a disequilibrium Maxwellian system in its otherwise far-from-equilibrium state, so the apparent disequilibrium operation of the system can be maintained stably as a new equilibrium condition. This appears to be a method to produce and utilize what Kondepudi and Prigogine refer to as a *nonequilibrium stationary state*. This stabilization is necessary in order for such a system to maintain its COP>1.0 excitation and steadily output more energy than the operator inputs, or to steadily power itself and its load {41}.

We also found that COP>>1.0 EM systems (and some COP>1.0 systems) produce (as a function of the COP) a current of Dirac sea holes (positrons) *in the local vacuum environment itself*, from the output section back to the input section. At COP<1.0 and COP not too greatly above 1.0, a Dirac sea hole in the vacuum almost immediately interacts with an orbital electron in the material lattice of the system. This converts the negative energy, negative mass "vacuum hole or state" into a lattice hole, which is attached to the large positive mass of the ion left by the disappearance of the electron. This "lattice positron" type of problem has been known in semiconductor design for some decades. Normal EM circuits do not usually meet the phenomenon overtly because the semiconductor designers controlled it in the semiconductors themselves by use of appropriate donors and acceptors.

There is a great difference between the actions of Dirac sea holes in the vacuum prior to observation, and lattice holes in materials (after observation). So there is a great difference between the action of a "positron" on spacetime before its interaction with mass and observation, and its action on spacetime after it interacts with mass and is observed.

For COP>>1.0, significant phenomenology and novel effects occur because a substantial fraction of the Dirac sea holes (unobserved positrons) sweeping from output to input do not convert to lattice holes (observed and bound positrons) along the way. For substantial values of COP above 1.0, Bedini's invention (patent application filed by Bedini and the present

---

*originally written the energy flow as  $\mathbf{S} = (\mathbf{E}\Delta\mathbf{H}) + \mathbf{G}$ , where  $\mathbf{G}$  is a circuital flux. Poynting had only written  $\mathbf{S} = (\mathbf{E}\Delta\mathbf{H})$ . Taking  $p$  to be the density of matter and  $e$  the intensity of a gravitational force, Heaviside found that the circuital flux  $G$  can be expressed as  $p\mathbf{u} / 4c$ , where  $\mathbf{u}$  represents the velocity of  $p$  and  $c$  is a constant."*

author)<sup>19</sup> covers the master process for intercepting and transducing this appreciable flow of negative energy from the output section back to the input. Otherwise, that flow — if not intercepted and not converted — will "eat" extra input electrons from the power supply, thus acting as a novel "extra load" appearing in the input section. That extra load then draws additional current and power from the external power supply by electron-hole annihilation<sup>20</sup>.

With the Bedini invention, the negative energy (unobserved positron) flow appearing at the input section is transduced into a flow of positive energy (a flow of electron current) from the input section back into the system. The process deliberately uses the "interaction and observation" process to phase conjugate the charge and reverse its direction of flow! In that case, the otherwise detrimental *negative* energy output back through the COP>1.0 system (which is nature's decay process for COP>1.0 interactions) is changed to a beneficial *positive* energy input within the system itself, freely received from the vacuum environment. This process is then used to close-loop the system for self-powering in a "locked" and stabilized disequilibrium condition — a nonequilibrium stationary state.

If we consider mass to be a special kind of positive energy state, then positive energy states represent curvatures of spacetime that are positive gravity. Negative energy states generate antigravity (the time-reversal of gravity).

---

<sup>19</sup> Bedini personally discovered and implemented the solution before the exact nature of either the problem or the solution was recognized! My contribution was to recognize the nature of the problem and the mechanism used in the solution. We also stress that, contrary to conventional treatment, all EM circuits do involve not only lattice holes in the conductors and components, but also Dirac sea holes in the local vacuum. That the Dirac sea is involved whenever there are EM fields is clearly shown by Felix Finster, "Definition of the Dirac Sea in the Presence of External Fields," *Adv. Theor. Math. Physics*, Vol. 2, 1998, p. 963-985.

<sup>20</sup> With a proper change in the curvature of local spacetime, pair annihilation can occur with no accompanying photon radiation. The condition is that the part of the curvature of spacetime representing the energy change of the otherwise emitted radiation, does not "relax" even though it is an "excited state". Rigorously, the emission of the radiation from pair annihilation occurs in two steps: (i) first the local spacetime is curved for and by the energy excitation, as a *static change* of the curvature, and (ii) then that curvature relaxes back to its former value, propagating that specific curvature in space, which is recognized as the radiation propagating in space. If the spacetime curvature excitation does not relax, there is no photon emission and propagation.



*Before their interaction and observation*, the Dirac sea hole (positron) currents — produced in natural COP>1.0 processes in the universe — are still negative energy electrons in 4-space. They are not 3-positrons until interaction with matter has occurred. These “negative energy electrons” generate negative energy EM fields, including both the Poynting energy flow component and the Heaviside nondiverged energy flow component. These negative energy EM fields appear to be *generating the antigravity* whose effects are seen in the distant parts of the universe. They produce far more powerful effects than the accounted electrogravitation effects in astrophysics, which only uses the gravitational effects of the very much smaller Poynting energy flow component. Also, astrophysicists do not use the “positron before observation,” when it is still a negative energy electron with negative mass. The accumulation of the negative energy (Dirac holes) in space (in the surrounding vacuum) is connected with massive objects and violent processes, where very strong gradients are produced.<sup>21</sup> As a result, very large negative energy fields and potentials are produced. In turn, this results in cumulating antigravity. This cumulating and interacting antigravity appears to be the mechanism for the forces *accelerating* the expansion of the universe — rather than it decelerating as would be the case if the net gravity there were positive. In Chapter 8 we propose this explanation for the observed acceleration of the expanding universe — and the basis for the explanation can be and has been successfully demonstrated in a legitimate overunity EM circuit or system {42}. We offer this in honor of Heaviside, who first discovered the gravitational aspect of his huge nondiverged energy flow, but did not live to publish it. He also did not consider the Dirac sea prior to hole interaction with matter, as it was not yet formulated, so he had not yet recognized the way to produce and utilize the practical antigravity potential of his discovery.

### 1.1.6 A Scientific Dilemma

There would seem to be a sufficient abundance of techniques, devices, processes, and theoretical works to impel a crash project in the scientific community to develop successful overunity electrical power systems {43a-43d}. This would be especially appropriate at this time, since the

---

<sup>21</sup> Kondepudi and Prigogine, *ibid.*, p. 459 already point out that strong gradients produce situations that violate present thermodynamics. Research in these and other situations violating present thermodynamics is going forward under the caption of “extended thermodynamics” research. A discussion of the area is given by D. Jou, *Extended Irreversible Thermodynamics*, Springer-Verlag, New York, 1996.

escalating energy crisis now threatens to slow the world economy, and then eventually collapse it. At this writing, the MidEast has heated considerably, and appears headed for another MidEast war, with resulting severe interruptions of cheap oil supplies from the MidEast. Nonetheless, in spite of Russia having opened its oil field spigots to try to fill the need, a crisis in oil appears to be looming.

So *why* does the U.S. scientific community still so adamantly oppose the very notion of Maxwellian systems freely extracting EM energy from the vacuum? Why is there no outcry pointing out what the hoary old Lorentz regauging really means in terms of equilibrium or disequilibrium of the regauged system with the active vacuum? The unequivocal participation of the vacuum in a continuous energy exchange with the charges and dipoles of every EM system has long been affirmed by particle physics. All the fields and potentials — and their energy — manipulated in any EM circuit come from the vacuum, as proven in particle physics for 45 years. Why have our electrical scientists not understood — from the broken symmetry of the vacuum exchange with the opposite charges of the source dipole between the charged terminals of every generator and battery — that *EM energy from the vacuum powers, and has always powered, every electrical power system and circuit ever built?* Why have the later rigorous broken symmetry findings of particle physics not been incorporated to update the ancient classical EM theory used to design and build electrical power systems, nearly a half-century after those broken symmetries were discovered and proven? Why do our classical electrodynamicists continue to assume that every charge and dipole in the universe is a perpetual motion machine, freely creating energy out of nothing and pouring it out across all space at the speed of light?

Therein lies one of the real problems of present science — its historical and continuing resistance to "out-of-the-box" thinking<sup>22</sup> and to research that overcomes conventional strictures. More than 40 years after the basis for the vacuum-energy powering of every dipolar system (and of every

---

<sup>22</sup> "Out-of-the-box" thinking is a widely used concept among planners and program formulators, when conventional thinking will not suffice to solve a major problem with which they are struggling. Conventional thinking is considered "in the box" thinking, so by demanding out-of-the-box thinking, a problem demands an unconventional solution outside those normally proposed. In short, some new thoughts and concepts are required. Much lip service is given to the concept as a favored buzzword, but few proposed programs with truly "out of the box" approaches will be funded. In the energy field, none at all are funded that are truly "out of the box", whether or not that or similar phraseology is used.

observable charge once its clustering virtual charges of opposite sign are accounted) was discovered and proven in particle physics, all our university electrical engineering departments continue to erroneously teach that the shaft energy input to the generator powers its external circuit. Internal EM energy in the generator, transduced from the input shaft energy, does not directly add a single watt to the external circuit. Instead, it only continually forces the generator's internal charges apart, to continually remake the source dipole, which then extracts energy from the vacuum and pours it out of the terminals, filling the space surrounding the conductors of the external system for the system to intercept and utilize some of the available external energy flow.

Once the dipole is established, it will extract and transduce EM energy from the vacuum and pour it out in all directions at the speed of light, without ceasing. Else, the Nobel Committee should admit its grave error and revoke the Nobel Prize awarded to Lee and Yang. Real observable EM energy extracted and transduced from the vacuum's virtual energy is precisely what the "broken symmetry of the opposite charges" on the ends of the dipole *means*. Indeed, all the forces of nature are already considered as generated by the interaction of virtual particles with observed particles. Since force produces energy changes in the system affected, then it follows directly that energy changes are produced by the interaction of virtual particles with observable particles.

However, our power system engineers ubiquitously use the closed current loop circuit. This inane circuit self-enforces the Lorentz symmetrical regauging condition. It uses half the energy captured by the external circuit (from intercepting some of that "energy flowing around the circuit from the seething vacuum" that is copiously pouring out of the generator terminals) to ram the spent electrons back through the back emf of the source dipole itself. That scatters the dipole charges and kills the dipole and its broken symmetry — and also kills the free flow of transduced EM energy from the vacuum.

That insane circuit kills the source dipole in the generator faster than it powers its external loads! So one has to keep rotating the shaft of the generator, to keep producing a magnetic field inside the generator, so that this magnetic field energy can continue to force the charges back apart and continually reform the source dipole.

In short, our engineers build the equivalent of an electrical windmill, then — so to speak — force it into a closed barn so the environmental wind

cannot reach it any longer. It is little wonder that we ourselves then have to do work on that "electrical windmill" to crank it around!

We pay the power company to engage in a giant wrestling match inside its own generator and *lose*. We also wildly pollute the planet with hydrocarbon and nuclear wastes, poison species (including killing of X numbers of humans every year via the disruption of their body functions and health), and enhance global warming. We are slowly strangling our biosphere and ourselves. None of that is necessary.

## 1.2 Organized Science Often Resists Innovative Change

The history of science is littered with examples where the scientific community has ignored the principle behind Einstein's statement quoted at the beginning of this chapter. As pointed out by Smith {44}, science has become reoriented toward profit. Quoting:

*"...science is not the danger; scientists encouraged to do bad science to survive are." ... "...changing the way modern science is funded is an enormous undertaking, but it is a necessary one if we want to protect our future. Call it managed risk."*

Science's resistance to change is so well known to historians of science that it is rather universally accepted — although usually not made explicit to undergraduates. Further, scientists are under great pressure to conform:

1. After all, science is *patronized*; someone must fund the laboratories, the research supplies, the salaries and personnel benefits, etc.
2. To procure and protect its patronage, science has become quite organized, particularly with respect to how the funds — received and channeled down from the top — are cut into individual packages (research grants and research programs) and made available for competition among the "performing" chain of universities and research laboratories.
3. In the last few decades, there has risen an increasingly fierce demand by universities that the scientific researchers (i) be successful in attracting outside funds and (ii) file patents assigned to the university. So fierce has this demand become, that the research professor's continued livelihood may literally depend upon his or her success in bringing in extra funding. Further, much of his time is now spent in writing proposals to

compete for these "packaged funds". When he wins them, the kind of research and the areas of research are already stringently defined, and he dare not deviate — else there will shortly be no more funding packages won, no funding for his graduate students, and soon thereafter there will be no job of any importance for the professor!

4. In the United States, all the government National Laboratories and our universities are intensely seeking and filing patents! So small, independent inventors cannot deal with these organizations, without risking and almost guaranteeing the loss of their patents and intellectual property. Funding dangled in front of the inventor, much like a carrot dangled in front of a horse, is often tied to "march in" rights {45, 46} calling for surrender of the inventor's patent rights altogether, *whenever the government — i.e., a single bureaucrat — wants to take it*. All that has to be done is to declare that the inventor is not getting it developed and to market fast enough. Science has thus become more avaricious and — some inventors would even say — it increasingly involves overt and covert piracy of intellectual property rights. From personal experience, reluctantly I would not argue with that statement. Simply ask Larry Fullerton of Time Domain Corporation about his struggle with a National Laboratory over patent rights to his ultrawideband communications invention and technology.<sup>23</sup> It eventually resulted in a "draw" of sorts. He did not lose his rights, but the government gained them also, in competition with him. The government *circumvented* his patent, even though they did not succeed in taking it. We were delighted to recently see that Larry (the company is Time Domain, Inc.) received its 74th patent in this technology, as well as a ruling that will allow the technology to at last go to market.
5. The result is a dramatic increase in the pressure on working scientists and independent inventors to conform, and to "play the game by the rules". Then everybody up the scientific food chain is fed, and is happy and secure. The journals happily publish the research papers and results, the professor gets

---

<sup>23</sup> Stephen Fenichell, "Radio Flyer," *Discover*, 22(5), May 2001. Fullerton's technology has been given a limited go-ahead by the FCC, which has drafted standards and regulations in the area as of February 2002.

funding for his graduate students, the university gets that wonderful overhead cut of the research funding — such as half or it or more — and the entire apparatus is like a very large and tidy Titanic adhering to its ponderous course toward the iceberg. Meanwhile, truly new and innovative science discoveries — vulnerable and desperately needing nurturing funding during their initial embryonic state — get shoved aside, crushed, and starved in the funding rush to adhere to performance of the *prescribed* funding packages.

6. In this environment, the day of the "defenders of the scientific faith" has arrived! A small percentage of conventional scientists who are dogmatic and vociferous, are now very prominently attacking any novel experiments and ideas with a vehemence seldom seen in organized science. It is again reminiscent of some of the noted scientific attacks in history, e.g., as pointed out by Hellman {47}. Yet, because of the financial pressure upon the scientific community, and the increased pressures to conform, there is little restraint of the dogmatists and they are almost never called to task. Cold fusion is a current example. The American Physical Society has recently issued a statement condemning perpetual motion machines — yet the society's members continue to condone and use a classical EM model that assumes every charge in the universe to continuously be creating energy from nothing. Even the American Physical Society has not recognized what broken symmetry of opposite charges means with respect to the common dipole and dipolarity in every circuit. Nuclear reactions at low spatial energy (which means at extraordinarily high total energy when the  $c^2$ -compressed time energy is considered) do indeed sometimes occur in carefully controlled experiments, whether or not we yet sufficiently understand the reactions theoretically, and regardless of whether we can get the anomalous results to happen every time. Yet this area of nuclear interactions at low *spatial* energy {48} — and unknown to the scientific community, at very high *time* energy {49, 50, 51} — has been savaged by these self-appointed spokespersons for the "official" community, none of whom even account the compressed energy in the time increment portion of the photon. More than six hundred successful experiments in multiple laboratories, by respected scientists in multiple nations worldwide, are now

rather resoundingly ignored. Yet the replication rate for good cold fusion experiments is certainly higher than many of the replication rates for novel and little-understood phenomena in large particle accelerators, and the cold fusion experiments are also *far cheaper*.<sup>24</sup> While particle accelerators are "popular" in their ability to garner huge funding, their cost/benefit ratio compared with, say, cold fusion experiments, may be abysmally low. Simply examine the decades of effort and many billions of dollars expended on the search for *warm* fusion (using spatial energy only). What has it produced, in terms of watts of power on the power lines? When will it produce any electrical power of any significance? Prototype cold fusion power systems have in fact been produced and patented {52}. With seed money from the scientific community and using a higher symmetry electrodynamics, cold fusion power could proceed at a rapid pace.

Strangely, the ever-present pressure to conform to *that which is already known and accepted* has often made science its own worst enemy throughout its history. Establishment scientists and the "system itself" now probably block — and have blocked over the decades — more innovative scientific research than does any other factor {53}.

### 1.2.1 Many Scientists and Historians Have Pointed It Out

The scientific community is well known to have always been highly resistant to novel ideas and innovations. Here are some selected pertinent comments regarding this phenomenon, where organized science is itself the obstacle to the advance of science, and where such has been recognized for many decades:

---

<sup>24</sup> As an example, see R. P. Taleyarkhan *et al.*, "Evidence for Nuclear Emissions During Acoustic Cavitation," *Science*, Vol. 295, 8 Mar. 2002, p. 1868-1873; Charles Seife, "'Bubble Fusion' Paper Generates a Tempest in a Beaker," *ibid.*, p. 1808-1809. See also Donald Kennedy, "To Publish or Not to Publish," *ibid.*, p. 1793. *Science* had the courage to publish the peer-reviewed results of a tabletop sonoluminescence experiment that apparently produces nuclear reactions. Editor Kennedy essentially advises all protagonists on both sides to cut the rhetoric and allow the scientific community to do its replication work, to either validate or refute the successful experiments of Taleyarkhan *et al.* This action by *Science* is a shining beacon to remind the scientific community that science is based on experimental method, and that prevailing theories cannot refute new experiments that contradict them. Instead, laboratory bench experiments must decide such an issue.

*"Every great scientific truth goes through three stages. First, people say it conflicts with the Bible. Next they say it had been discovered before. Lastly they say they have always believed it." [Louis Agassiz, 1807-1873.]*

*"There are three steps in the history of a great discovery. First, its opponents say that the discoverer is crazy; later that he is sane but that his discovery is of no real importance; and last, that the discovery is important but everybody has known it right along." [Sigmund Freud].*

*"Anybody who has studied the history of science or worked as a scientist knows that whenever something novel is discovered or proposed, there is a polarization of scientists, with hostility and bitterness that may last for generations. What wins arguments is scientific fact, and that may change as the years go by. A good example of this is the geological theory of continental drift, as proposed by Wegener in 1912. When I studied geology around 1950, continental drift was acknowledged in my undergraduate textbook as a crank theory. The first serious confirmation was in 1956, and it was finally established as the dominant theory in the early 1970s. Until that time, anybody who admitted that he or she believed in continental drift was the subject of derision and scorn. Sorry, folks, science is not and has never been the 'idealized portrait painted in textbooks'." [Allan Blair] {54}*

*"... the four stages of response to any new and revolutionary development [are]: 1. It's crazy! 2. It may be possible — so what? 3. I said it was a good idea all along. 4. I thought of it first." [Arthur C. Clarke]. {55}*

*"...I suggest that most revolutions in science have taken place outside the lofty arena of the refereed journals, and with good reason. The philosophy by which these journals govern themselves virtually precludes publication of ideas that challenge an existing consensus." [William K. George] {56}*

*"At every crossway on the road that leads to the future, tradition has placed against each of us, 10 thousand men to guard the past." [Maeterlinck].*



*"An important scientific innovation rarely makes its way by gradually winning over and converting its opponents: it rarely happens that Saul becomes Paul. What does happen is that its opponents gradually die out, and that the growing generation is familiarized with the ideas from the beginning." [Max Planck] {57}.*

*"Peer review is widely seen as a modern touchstone of truth. Scientists are roundly drubbed if they bypass it and 'go public' with their research... The first limitation of peer review is that nobody can say quite what it is... A more pernicious danger is that peer review may reject the important work. As Charles W. McCutchen, a physicist at the National Institutes of Health, has put it, peers on the panel reviewing a grant applicant 'profit by his success in drawing money into their collective field, and by his failure to do revolutionary research that would lower their own ranking in the profession. It is in their interest to approve expensive, pedestrian proposals.' " [Jonathan Schlefer] {58}.*

The sheer massive size and inertia of the modern scientific establishment also exert mind-numbing difficulty in "hearing" and recognizing an innovative scientist's message, even a message of utmost importance, and even if it gets through the censors. For example:

*"We used to be able to say things once; if the message was reasonable, it had a good chance of becoming a permanent part of the structure of the field. Today, a single publication is lost; if we say it only once, it will be presumed that we have changed our mind, and we therefore must publish repeatedly. This further fuels the large publication volume that requires us to repeat." [Rolf Landauer] {59}*

### **1.2.2 Some Specific Examples**

There are hundreds of examples of new discoveries in science that have at first — and often for an extended period of years — been severely obstructed and ridiculed. Here are just a selected few:

#### **1.2.2.1 Conservation of Energy**

Von Mayer {60}, the discoverer of the modern statement of the conservation of energy and the mechanical equivalent of heat, was severely chastised for his "insane" work. He was hounded and severely

ridiculed. This extremely harsh treatment, together with domestic problems, drove him to a suicide attempt and a nervous breakdown, and into psychiatric treatment for some years. Toward the end of his life, his principle of energy conservation had so greatly increased the ease of calculations and the understanding of systems that the same scientific community — due to the commendable efforts of Helmholtz, Clausius, and Tyndall — began to recognize his great contributions and lionize him. In 1867, he was made a member of the nobility, dying in 1878 with his "insane" work by then well respected. He was fortunate to have the "cur dog attack" reversed in his lifetime. Most scientists with novel discoveries are not so fortunate.

#### **1.2.2.2 Continental Drift**

Alfred Wegener {61} proposed the theory of continental drift in 1912. The reception was extraordinarily hostile. So ferociously was he ridiculed for the notion that huge continents of rock could "float" and "drift" that his very name, "Wegener", was often used as a synonym for "utter idiot". To refer to someone as "a Wegener" was to cast the greatest slur possible upon that person's mental powers and to label him a gibbering lunatic. Only in the 1960s when sea-floor spreading from ocean ridges was discovered, proving that ocean basins are not permanent features, did Wegener's concept of continental drift concept finally gain acceptance.

#### **1.2.2.3 Kinetic Theory of Gases**

As pointed out by Paul Nahin {62}:

*"J. J. Waterston's paper on the kinetic theory of gases, in 1845, was rejected by the Royal Society of London. One of the referees declared it to be 'nothing but nonsense, unfit even for reading before the Society.' ... 'Waterston's dusty manuscript was finally exhumed from its archival tomb forty years later, because of the efforts of Lord Rayleigh..."*

Lord Rayleigh was the Secretary of the Royal Society when he had Waterston's paper reprinted nearly a half-century after submitted. Lord Rayleigh also gave an introduction to the paper, regretting it lying so long unpublished when its content was quite important. His introduction is a way of explaining the delay.<sup>25</sup>

---

<sup>25</sup> Waterston's paper was finally published as John James Waterston, "Free and Elastic Molecules," *Phil. Trans. Roy. Soc. Lond.*, Vol. 183, 1892, p.1-79. Lord

**1.2.2.4 Surgical Pain Deemed Necessary**

It has *always* been this way in science. As another example, the famed surgeon Alfred Velpeau wrote in 1839:

*"The abolishment of pain in surgery is the chimera. It is absurd to go on seeking it today. 'Knife' and 'pain' are two words in surgery that must forever be associated in the consciousness of the patient. To this compulsory combination we shall have to adjust ourselves."* [Martin Gumpert] {63}.

Wryly we observe that today a similar attitude of "we must glory in the pain" — where the "pain" is due to the yoke of COP<1.0 EM systems and of the second law of classical equilibrium thermodynamics — consumes most modern electrical power system scientists and engineers.

**1.2.2.5 The Photoelectric Effect**

Almost every household now knows Albert Einstein's epochal achievements. Yet his formative three papers — on Brownian motion, the photoelectric effect, and special relativity — were published in 1905 while he was working in the Swiss Patent Office. The most renowned physicist of the time was Max Planck. Planck was embarrassed that a scientist who was not even employed in physics was doing such important work in physics. So Planck and other scientists arranged for Einstein to be awarded a chair in physics at a proper university. In their letter to the university, they pointed out Einstein's brilliance in his papers. They also then excused him for straying down the road of the photoelectric effect, because — as they put it — everybody knew that was foolishness, but persons of such brilliance could be forgiven a few such little bobbles along the way. Years later, in 1921, Einstein was awarded the Nobel Prize for Physics, for his work in theoretical physics and *especially* for his explanation of the photoelectric effect.

The Einstein incident is a typical illustration of Arthur C. Clarke's cogent observation:

*"When a distinguished but elderly scientist states that something is possible he is almost certainly right. When he states that something is impossible he is very probably wrong."* [Clarke's First Law]

---

Rayleigh's introduction and Waterston's paper also are given in Jefferson Hane Weaver, *The World of Physics*, Simon and Schuster, New York, 1987, p. 632-651.

### 1.2.2.6 Amorphous Semiconductors

Stanford R. Ovshinsky's development of amorphous semiconductors {64, 65} is another modern example. "Everybody knew" that a crystalline structure was necessary in order to have a semiconductor at all; in short, a semiconductor formed out of non-crystalline material was deemed to be totally impossible, never mind this "phase" change that Ovshinsky advanced. However, some young graduate students, e.g., began to look at Ovshinsky's amorphous materials and his phase change approach.

Finally funded by the Japanese, Ovshinsky's company, Energy Conversion Devices, Inc. (ECD) simply placed its amorphous semiconductor devices into working equipment. Copy machines appeared with his amorphous semiconductors installed in them — with the machines and their amorphous semiconductors working very well. More graduate students and post-docs enthusiastically entered the area, did research, and wrote dissertations.

As a result, amorphous semiconductors finally became accepted, and they are now part of the established technology and scientific knowledge base. The interested reader can simply look up Ovshinsky's company and statistics on <http://www.ovonics.com>. The Japanese have reaped a continuing bonanza from the sales of amorphous semiconductors, because of the shortsightedness and bias of the U.S. scientific community.

## 1.3 Scientific Disagreement or Street Fight?

It is one thing to scientifically disagree — even strongly — in a technical and courteous fashion, and quite another to engage in ad hominem attacks. The first is science; the second is a cur dog fight. Unfortunately the history of science far too often reveals "cur dog fights" instead of respectful scientific disagreements {66}.

A recent modern example of legitimate research and qualified researchers still being savaged in a "cur dog fight" manner is cold fusion (low energy nuclear reactions). Quoting one learned orthodox scientist, whose name is withheld, speaking to a learned scientist in cold fusion:

*"How stupid do you think we are? My assessment of you and your colleagues is that you are complete frauds or totally mad. There is no known physical principle that would support the kind of results that you claim your technology can accomplish, nor is there any credible argument why there should be such a principle."*

We answer that "cur dog attack" unemotionally and scientifically. The key is in the scientist's own phrase: "no *known* physical principle." If the experiments work and are replicated, but are not understood by the conventional theory, then they refute the prevailing theory, whether the physical principle is understood or not. Else scientific method has been totally abandoned in favor of "truth by authority and dogma". The experiments clearly show that a previously *unknown* physical principle is at work. The real task then is to rediscover this new principle — that being one of the primary ways that science advances. We propose new principles in this book as a possible explanation of those experiments.

The dogmatic scientist's statement was made in spite of some two hundred (200 at that time; now more than 600) scientific experiments worldwide, in many nations, many at prestigious institutes, where dozens of scientists have reported positive and anomalous results in cold fusion experiments.

So yes, there is indeed a very "credible argument" — *the results and replicability of the experiments*, which are supposed to be the *decisive* statement of science. If that view in science has changed, then we are no longer practicing the scientific method. Instead of accepting successful and replicable experiments and seeking to change the model, the scientist is insisting that we must first understand the principle and thus have a model. This of course is a total violation and reversal of the scientific method. We used aspirin effectively for decades without the slightest notion as to the mechanism enabling its beneficial actions. The mere fact that "there is no known physical principle" for the results achieved has nothing to do with the validity of the replicated experimental results. Instead, it merely substantiates that *there should be a vigorous scientific program to uncover the new principle or principles obviously involved*, since the old model has either failed or been revealed as too limited.

The derogatory statement by the dogmatic scientist is also made from the viewpoint of the conventional nuclear physics model. The conventional physics has not taken into account that all 3-spatial electromagnetic energy associated with charges and dipoles and their fields and potentials in fact comes from the time domain {85, 86, 12, 19}. It has also not taken into account that time itself (as in the time component transported by the time-polarized photon or a time-polarized EM wave) may be comprised of extraordinarily dense energy. Indeed, time appears to be spatial EM energy compressed by the factor  $c^2$ , so it has the same energy density as mass {67}, which we pointed out earlier. The smaller the *spatial* energy of the

photon, the greater its time component and hence its *time*-energy in seconds expressed in decompressed spatial energy joules<sup>26</sup>. The highest energy particle physics is not *spatial*-energy physics as presently practiced, but *time*-energy physics, where some of the time-energy of photons is transduced into spatial energy. One second of time transduced (decompressed) into spatial energy yields approximately  $9\Delta 10^{16}$  joules. Further, every negative charge in the universe continuously accomplishes that decompression, and every positive charge continuously accomplishes the recompression.

In other words, not all physical principles were discovered in the particle physics of, say, five years ago, as the literature since then clearly shows. To assume that everything is already known today is ludicrous; science is never completed. The new principles reported in the present book now are at least "candidates" for the physical principles that do support cold fusion results. There is also another powerful argument for these hypothesized principles: they have produced the final resolution of the source charge problem — something for which the arch skeptic quoted has no solution whatsoever, and which he himself cannot explain. *If the arch critic cannot produce an alternate solution to the source charge problem, and is unaware of that new principle that may solve it, let him go and learn the new principle. Until then, he unwittingly assumes that every charge in the universe is a perpetual motion machine, continuously creating and pouring out EM energy in all directions at the speed of light.* So we return his own argument and approach to him: he should attack the conventional scientific community for accepting the source charge, while having absolutely no principle to explain how it continuously pours out observable EM energy without any observable EM energy input. In short, he should practice what he preaches; else he brands himself a total hypocrite. The alert reader will note that none of the arch skeptics doing all the ad hominem attacks on cold fusion and COP>1.0 EM systems are practicing what they preach.

---

<sup>26</sup> The spatial energy of the photon decreases linearly as the frequency is lowered, while the time component in seconds increases linearly. But the highly compressed time energy, comprising that time component, increases nonlinearly (by the factor  $c^2 \div t$ ). Hence the highest energy photons are actually the low frequency photons — something completely alien to particle physicists — and not the high frequency photons chased by "high energy physics". Indeed, high energy physicists are practicing a high spatial energy physics, which — overall — is a much lower energy physics than radar, microwave, VHF, or ELF, *if the total energy of the photon, to include its time energy, is considered.*

What we are saying is this:

- (a) If one's physics knowledge was current five years ago, it may be stale today. A few years ago, no one believed the expanding universe was accelerating. Today we know that it is, rather unequivocally. And by "no known physical mechanism". We will later present a strong candidate for that missing mechanism. The results of experiments will substantiate or refute it.
- (b) The proposed principles in this book, e.g., are newer, and may shed light on the mechanism for the cold fusion results as well as other phenomena. The experimental results themselves are irrevocable; any proposed explanation requires validation.
- (c) The new principles do explain cold fusion and are consistent with the phenomena encountered in multiple experiments by multiple researchers in many laboratories. We readily admit that the stale and incomplete principles presently utilized in nuclear physics *do not* explain cold fusion. Neither do they explain how a charge continuously pours out EM energy. So do the skeptics attack all those physicists who believe in source charges and their provision of the fields and potentials and all EM energy? Of course not. They themselves believe in that greatest of all "perpetual motion" *faux pas*.
- (d) The proposed new principles also solve the source charge problem, which is still ignored by most conventional physicists and electrodynamicists, even though often referred to as the "most difficult problem in electrodynamics" {68}.
- (e) Scientists should not be close-minded, but should consider new proposals and let the experimental results decide their validity or falsity — precisely the position taken by the journal *Science* in publishing the results of some new cold fusion experiments. That is the scientific method in action.
- (f) Those scientists who remain close-minded, and viciously attack experimentally demonstrated new processes and mechanisms, are guilty of practicing dogma and not science. They are in fact guilty of being what they so frequently charge: *pseudo-scientists*.

When science does not allow proposed new mechanisms and principles to be considered in science following demonstration of new phenomena inexplicable by present models, then science is no longer practicing scientific method. When any scientist rejects these demonstrated new

experimental phenomena out-of-hand, he is practicing dogma rather than science. The “friendly skeptic” attitude is welcomed and appropriate. The cur dog attack has no place in science, but only among cur dogs — and those who behave like them.

## 1.4 A Few Significant and Unresolved Scientific Problems

### 1.4.1 Time as Structured Energy

Time also has internal structure and dynamics {69, 70}, as we explain later, as well as the same energy density as mass. So it should not be surprising that a tiny bit of time-energy, transduced into ordinary spatial EM energy, might be capable of energetically inducing a wide variety of nuclear reactions. One has transduced not only "gross" energy, but also energy structuring and dynamics — which *act internally* on any object with which interaction occurs. Further, the overall spatial energy component and the time-energy component in a photon are canonical. Being quanta, all observable photons have the same fixed "total magnitude" with respect to angular momentum. The photon is also "made" of  $(\div E)(\div t)$  which may be taken as  $(\div E)(c^2 \div t)$  in terms of *purely spatial* energy equivalent content, assuming that the time energy is decompressed into spatial energy. As can be seen, the so-called "low (spatial) energy" photons are precisely the photons that transport the greatest time-component. When that time-energy component  $(\div t)$  is converted to spatial energy  $(\div E_C)$ , the formula is  $(\div E_C) = c^2(\div t)$ . As can be seen, the converted time energy will produce far more spatial energy in the *converted* interaction, than was carried by the photon in its spatial energy  $(\div E)$  component prior to interaction and time-energy transduction. Hence the highest energy photons are actually low frequency photons — under the circumstances where time-energy transduction into spatial energy is involved. With transduction, the highest energy particle physics can be conducted at low frequencies and low spatial energy if conversion of time-energy occurs in the interaction.

Since cold fusion involves transduction of a little bit of the time-energy, the total lack in physics of knowledge of time-energy transduction into spatial energy explains why conventional nuclear physicists find the cold fusion results so confusing and astonishing.

### 1.4.2 The Obsolete Foundations of Classical Electrodynamics

Another modern example of science's resistance to change is the failure to update classical electrodynamics to include the active vacuum interaction



and the interaction with the local curved spacetime<sup>27</sup>, as we shall discuss in Chapter 2. It has been scientifically established (in particle physics) that there can be no equilibrium of any physical system without accounting for the vacuum interaction.<sup>28</sup> To simply observe a physical electrical power system sitting there stably and running, is to prove its vacuum interaction in order to even *have* such equilibrium.

An interesting point then arises since every charge and dipole in the system is a *broken equilibrium* in the exchange between the material system and the vacuum. Not only does an electrical circuit receive some energy from the vacuum, but also the energy from the vacuum is *massively hemorrhaging* from the vacuum into the system (and back out)! The isolated charge, e.g., is infinite if one removes the screening clustered virtual charges of opposite sign, as is well known in modern physics. Further, the screening virtual charges also have infinite charge, again as is well known. The difference between these two infinite values of charge, e.g., gives the standard finite observed charge of the charged particle. The lay reader may wish to positively verify that statement; e.g., as given by Nobelist Steven Weinberg.<sup>29</sup> Quoting:

*"[The total energy of the atom] depends on the bare mass and bare charge of the electron, the mass and charge that appear in the equations of the theory before we start worrying about photon emissions and reabsorptions. But free electrons as well as electrons in atoms are always emitting and reabsorbing photons that affect the electron's mass and electric charge, and so the bare mass and charge are not the same as the measured electron mass and charge that are listed in tables of elementary particles. In fact, in order to account for the observed values (which of course are finite) of the mass and charge of the electron, the bare mass and charge must themselves be infinite. The total energy of the atom is thus the sum of two terms, both infinite: the bare energy that is infinite*

---

<sup>27</sup> We again stress the concept of the *supersystem*, introduced in footnote 11.

<sup>28</sup> E.g., see T. D. Lee, *Particle Physics and Introduction to Field Theory*, Harwood, New York, 1981. On p. 380-381, Lee shows how there is no symmetry of matter alone, but only of matter and vacuum.

<sup>29</sup> Steven Weinberg, *Dreams of a Final Theory*, Vintage Books, Random House, 1993, p. 109-110.].

*because it depends on the infinite bare mass and charge, and the energy shift ... that is infinite because it receives contributions from virtual photons of unlimited energy."*  
[Steven Weinberg].

So a simple charged particle actually involves a polarization of the vacuum involving two charge energy functions — the bare charge and the charge change functions — each of which has a known and recognized COP =  $\leftarrow!$

*A priori*, the conventional system's overall actions must incorporate functions (whether intentional or unintentional) that continuously adjust to provide *net equilibrium in that exchange by adjusting the hemorrhaging-out to equal the hemorrhaging-in*. In this book, we will spell out just what those unintentional functions are, such as the ubiquitous closed-current-loop circuit, and how to beat them so that excess energy from the vacuum can be utilized by the system to power the loads.

### **1.4.3 What Powers an EM Circuit or Electrical Power System?**

Another modern example of science's resistance to change is the continued engineering of electrical power systems with the erroneous notion that mechanically powering the shaft of a generator directly powers the power line. The notion is that the generator transduces some of the mechanical shaft energy into output EM energy added to the power line {71}. To the contrary, *all EM systems are powered by energy extracted from the vacuum*. They are not powered by the mechanical energy we input to the shaft of a generator, or by the chemical energy in a battery. In this book, we discuss at some length what powers the EM system, and we have previously published the basis for our "shocking" statement {12, 72}. The basis for how an EM system is powered by energy from the vacuum has been known in particle physics for nearly a half-century {73}, since the experimental proof of broken symmetry {74}, including the broken symmetry of opposite charges (and hence of any dipole) in its fierce energy exchange with the active vacuum {75}.

A generator or battery expends all of its available energy to separate its internal charges and form its source dipole between the terminals. Once made, the dipole's broken symmetry — in its violent energy exchange with the active vacuum — converts virtual photon energy absorbed from the vacuum into observable EM energy, and emits it — *pours it out* — through the terminals and along the power line, filling all space around the conductors.

If one wishes to appreciate the enormity of the vacuum changes engendered by formation of that source dipole, simply visualize those two

infinite charge energy functions (from Weinberg's quotation above) for every charged particle on the ends of that dipole. The dipole then is a great set of offsetting infinities in EM energy (photon energy) boiling and being ordered in the vacuum. Making a simple little dipole or producing a simple charge initiates into motion an enormous set of infinite energy changes in the vacuum! None of these startling, enormous vacuum energy changes and functions is modeled in classical electrodynamics and electrical power engineering. So when we speak of the Heaviside nondiverged energy flow component pouring from the terminals of a generator, as being a trillion or ten trillion times as great in magnitude as the intercepted Poynting component, the reader should not be appalled. The reader should recall that we are dealing with the difference between sets of infinities that combine to provide finite differences. These finite differences can be very small, or they can be extraordinarily large, depending on the exact situation. In the case of a source dipole formed in an ordinary generator or battery, the difference of the infinities is very large.

Figure 1, adapted from Kraus {76}, illustrates that small part of the external energy flow around a typical transmission line that is intercepted by the surface charges and their fields, and that is drawn into the wires to power the circuit as these charges are driven axially back and forth across the conductors. The surface charges are constrained to the "drift velocity" (usually a few inches per hour) movement down the wire by repulsion of the electrons ahead of them.

The spinning, *longitudinally restrained* electrons precess laterally, thus withdrawing across the transverse axis of the wire. So the laterally precessing electron withdraws a little ways, withdrawing that first small portion of its fields and their energy increased by intercept of additional energy from the outside energy flow. The further part of the fields is not withdrawn into the conductor, and is not used to power the electrons.

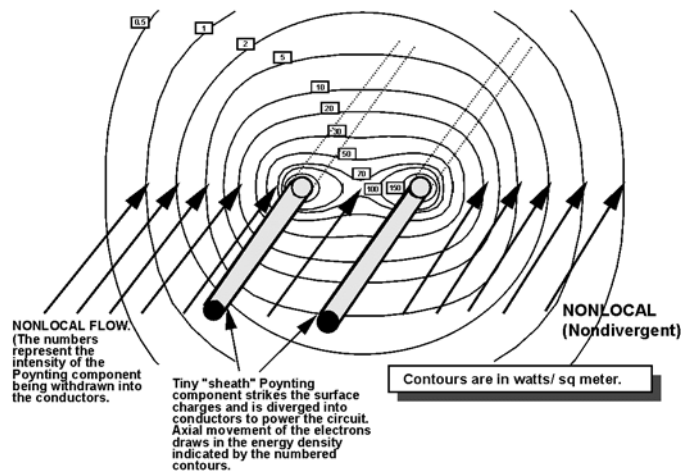

Figure 1-1 Poynting (caught energy) flow contours surrounding a transmission line.

Most of the available energy flow misses the circuit and is not drawn into the conductors. However, that large component is not shown by Kraus, and Poynting did not consider it. Heaviside {5c} pointed out that the remaining flow component is hardly reduced (hardly changes direction) from the entire flow component before the extraction of the small Poynting component. Given sufficient intercepting charges outside the wires in separate receiving circuits, the total remaining energy flow that could potentially be intercepted is enormous — far more than the feeble amount of energy that is input to the generator shaft or that is in the chemical energy of a battery.

This is easily established by actual experiments placing intercepting charges in separate "receiving" circuits in the otherwise nondivergent energy flow outside the conductors, or one may show it with Bohren's experiment {24}. Collecting additional energy completely outside conductors is one part of the COP>1.0 operation of the motionless electromagnetic generator (MEG) {37}, to be discussed later in this book. The Sweet device {29a} established sustaining self-oscillation of the

barium nuclei in a barium ferrite magnet, by using the surrounding vacuum as a semiconducting medium.<sup>30</sup>

#### 1.4.4 The Incompleteness of Aristotelian Logic

Another false notion usually perpetuated in much of science and mathematics is that Aristotelian logic is complete and consistent {77, 78}. To the contrary, it is both incomplete and inconsistent, as is easily shown. Let us use the symbols "A" for a particular thing, " $\bar{A}$ " for that which is not-A, " $\Sigma$ " for "is identical to," " $\neq$ " for "is not identical to," " $\vee$ " for "or", and " $\wedge$ " for "and". Using these symbols, the three laws of Aristotelian logic may be expressed as follows:

$$A \Sigma A \quad [2]$$

$$A \neq \bar{A} \quad [3]$$

$$A \vee \bar{A} \quad [4]$$

The first law states that a thing is identical to itself. The second states that a thing is not identical to that which is not itself. The third states that a thing is either itself, or it is something else. Those are the three laws of Aristotelian logic. As written, the process of perception, observation, etc. *has been excluded*. More on that in a moment.

Specifically excluded are the laws

$$A \neq A; A \Sigma \bar{A}; A \wedge \bar{A} \quad [5]$$

Which says that a thing is not identical to itself but is identical to something else that is not itself.

Heraclitus posed a profound challenge to Aristotelian logic, a challenge that has not been adequately resolved by Aristotelians to date. He simply observed that, for a thing to change, it had to change into something else. "But then," he asked, "how can a thing be itself but also something else as

---

<sup>30</sup> E.g., see Richard E. Prange and Peter Strance, "The Semiconducting Vacuum," *Am. J. Phys.*, 52(1), Jan. 1984, p. 19-21. The vacuum may be regarded as a semiconductor. In particular, the vacuum in the region close to the nucleus of a superheavy element is analogous to the inversion layer in a field effect transistor. The authors introduce the idea of the inverted vacuum. Just as a semiconductor may be manipulated by subjecting it to external fields, doping etc., it appears that so can be the vacuum.

well?" In philosophy that is still known as the unresolved "problem of change". It has no resolution in Aristotelian logic, but can be resolved in an extended logic we shall advance. The solution to Heraclitus' problem of change is the nature of observation, as advanced in this book.

We now critique Aristotelian logic, by observing a simple Venn diagram of the type used in "proving" logic theorems in axiomatic logic. See Figure 1-2.

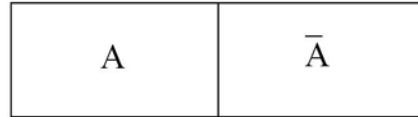

1-2a. Usual Venn diagram of  $A$  and  $\bar{A}$ .

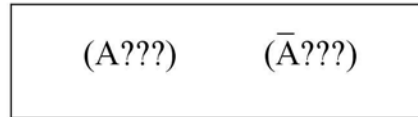

1-2b. Applying second and third laws to divider.



1-2c. Applying second and third laws to divider and outer boundary.

**Figure 1-2 Applying Aristotle's laws to Venn diagram used to prove logic theorems destroys the entire diagram.**

In Figure 1-2 a, we have introduced a dividing boundary line between  $A$  and  $\bar{A}$ . *Unfortunately that dividing line belongs entirely to both  $A$  and  $\bar{A}$ .* So it violates all three Aristotelian laws, and must be removed.<sup>31</sup>

Therefore, we remove it in Figure 1-2 b. Now we have neither a discernible  $A$  or a discernible  $\bar{A}$ , but we have removed naught but the boundary separating them, so we may argue that they are both still there although not discernible. However, if they are not discernible, we cannot distinguish what  $A$  is or what  $\bar{A}$  is, and so we cannot discern whether they

---

<sup>31</sup> A clever fellow once proposed regarding the boundary as a total discontinuity, being neither  $A$  nor  $\bar{A}$ . However, in that case  $A$  and  $\bar{A}$  could never meet, so there could not be a cause interacting with not-cause to produce an effect. So that suggestion as to how to "fix" Aristotelian logic does not hold.

are identical or not. Here again this violates all three laws of Aristotelian logic, so we have to remove the diagram. Indeed, the outer rectangle line is also such a boundary, between the "inside" and the "outside" (the not-inside), and so it must be removed. In compliance with Aristotle's laws, we are left with the trivial diagram shown in Figure 1-2 c, which is nothing at all.

If this Venn diagram method is objected to, then we must insist that all those papers and texts using that method of proof of logic theorems be either abolished or corrected!

Sometimes the objection is raised that, as far as the center boundary line is concerned in Figure 1-2a, the line "belongs to A on the left and belongs to  $\bar{A}$  on the right". Fine! Then we have a unique situation where a line (call it L) is an entity made of two entirely different things, which we may refer to as  $L_L$  and  $L_R$ . Yet  $L \sum L$ , without any qualifications as to "sides"  $L_L$  and  $L_R$ . It can be shown that every point in L is a point in  $L_L$ , and is simultaneously a point in  $L_R$ . The point in L is obviously identical to itself, by Aristotle's first law. Further, the same point in  $L_L$  and in  $L_R$  is identical to itself, by the same first law. But  $L_L$  is the set of all such points, and so is  $L_R$ , and so is L. Therefore  $L \sum L_L \sum L_R$ , since each one consists of each point that the others consist of. There is absolutely no distinction between the three things themselves, unless we are to violate Aristotle's laws.

Note that in passing from left to right across the boundary, a "change" occurs. This simply re-resurrects Heraclitus' original objection that, according to Aristotelian logic, there can be no change. That is, a line cannot change from "a different entity as seen from the left" compared to that entity as seen from the right. None of Aristotle's three laws contains a "left and a right" for A or  $\bar{A}$ .

So the question of logic is a little more complex than writing three simple laws and drawing simplified Venn diagrams. In short, one cannot have Aristotelian logic without having something else *outside* it, which follows directly from Gödel's theorem and proof {78}. Note that we are introducing the required notion of "perception" into the formal notions implied as axioms in Aristotle's laws, as that "something outside the prescription of the laws themselves" and in addition to them. We are perfectly free to *use* Gödel's theorem and observation.

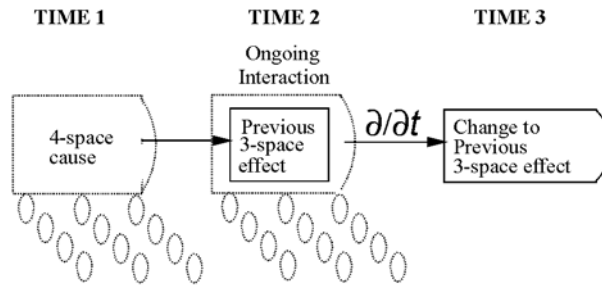

Figure 1-3 Mechanism for observation of change to a previous observation.

See Figure 1-3. We now add the notion that a thing is a perceived, thought, or observed thing. So let us use the symbol  $\Rightarrow$  to mean *explicit*, i.e., *output* by a given perception, thought, or observation process as the result of a  $\epsilon/\epsilon t$  operator having been applied to whatever exists prior to perception, thought, or observation. The symbol  $\Leftrightarrow$  is used to mean *implicit*, e.g., when one observes an observation "Y" at time two, and later is deciding in time three whether or not that observation "Y" in time two is identical to a previous observation "X" made during time one, then *memories* of the observations of X and Y are involved in time three rather than the observations X and Y themselves, and so the observations of X at time one and Y at time two — by whatever manner they were observed and according to whatever decision algorithm is used — is said to be "implicit".

We note that we can know nothing about the so-called "thing in itself" *without* thought, perception, observation, or other process involving  $\epsilon/\epsilon t$ . Further, at the moment the  $\epsilon/\epsilon t$  operator is applied, time momentarily ceases. The resulting perception, thought, or observation exists therefore as a "frozen output" at that single moment in time. To have it "persist" or exist a moment later, we have to apply the  $\epsilon/\epsilon t$  operator *again*, and stop time again, so that we again perceive, think, or observe.

But at any moment later than when we made a particular perception, thought, or observation of "A", *that* specific "perceived A" no longer exists, except in our memory as a recording of "observed A" that we can *continually recall*. Our conscious mind is a very fast serial processor, with only one "perception" or "thought" at each fleeting moment — only one



slide at a time in the slide projector, so to speak. But it is very rapid. However, our so-called "unconscious" mind is totally conscious, just multiply so. It is a massively parallel processor, and has "a great many slides in the slide projector" at any given time.<sup>32</sup> Hence in our genetic multiprocessor mind, we can indeed record, recall, compare, etc. — and perform all the modern massively parallel computer operations.

Let us now re-examine the three Aristotelian laws. Let us label the "slide snapshots" with the time instants when each "perception, thought, or observation" is or was consciously made, by use of a subscript, such as  $A_1$ , which means *what was perceived, thought, or observed as "A" in time-snapshot 1*. Let us also note that each of the symbols  $\Sigma$ ,  $\neq$ ,  $\forall$ , and  $\wedge$  actually involves the output of a *comparison and decision algorithm* in the massively parallel processor, after the two observations  $X_1$  and  $X_2$  were made. Let us use the symbol  $\heartsuit$  to mean "results in the decision that" or "implies that". As a check for identity, e.g., simple comparison algorithms for determining identity or nonidentity might be

$$\{[A_1 - A_{(2)}] = [0]_3 \heartsuit_4 (A_1 \Sigma A_2) \quad [6]$$

$$\{[A_1 - A_{(2)}] \Pi [0]_3 \heartsuit_4 (A_1 \Sigma A_2) \quad [7]$$

Thus we more precisely rewrite Aristotle's laws as

$$A_1 \Sigma_3 A_{(2)} \quad [8]$$

$$A_1 \neq_3 \bar{A}_{(2)} \quad [9]$$

---

<sup>32</sup> E.g., this can be seen by a moment's reflection. At any one time, the "unconscious" mind is controlling and directing a great multitude of ongoing physical processes, is also processing short-term and long-term memory processing, filing conflicts for resolution or later presentation to the conscious mind in symbolic fashion, etc. One can physically measure the electromagnetics associated with this activity, after the mind transduces its time-polarized EM interactions into 3-space EM actions. The process is two-way, and certain recorded EM stimuli will be "reverse-processed" back to affect the time-polarized EM operations of mind. Mind operations are electromagnetic; but they use time-polarized (scalar) photons and time-polarized (scalar) EM waves which are unobservable a priori. Mind operations are also electro-dynamically engineerable, but that is beyond the scope of this treatise.

$$A_1 \vee_3 \bar{A}_{(2)} \quad [10]$$

Where — surprise! We have now accounted for all those different times and periods of observations, processing, comparison, decision, etc. We are dealing not with some mystical "thing-in-itself", but with interactions (perceptions, thoughts, observations, associations) in the mind and psyche of the observer. And hidden in time 3 is the application of a decision algorithm such as given in [6] and [7] above.

Now the first law [8] states that in time one an observation was made and named "A", notated ( $A_1$ ), by comparing it to a previously recorded observational memory of what we call "A". The existence of that *memory* of what we call A is implicitly assumed in the first law, as well as the others. We do not show the memory itself in [8], [9], and [10]. In time two an observation  $X_2$  was made (not notated), but it is not then known at the moment whether that  $X_2$  is A or  $\bar{A}$ . So in time interval three the decision algorithm to determine identity or non-identity occurred in the mind, and the zero output of that algorithm [6, 7] established that  $A_{(2)}$  was actually identical to  $A_1$ , *according to the decision algorithm actually used. The algorithm matters, and it too is a variable.*

A similar process occurs in law two [9], but this time the algorithm had a different output. Note that the little line over  $X_{(2)}$  to make it  $\bar{A}_{(2)}$  was not assigned until time interval four (not shown) after the decision algorithm had given its output in time interval three.

The second law merely states that the operation of the decision algorithm in time interval 3 found the two snapshots (in time 1 and in time 2) not to be identical, *by the decision algorithm and comparison process utilized. Again, the algorithm matters, and it too is a variable that must be taken into account.*

All three laws [8, 9, 10] written one after the other assume that the identity algorithm does not change between snapshot 1 and snapshot 2, in all three of them. This is the key point.

With two different versions of the identity decision algorithm, the results of two different comparisons may differ. If the identity decision algorithm does not change during the time between snapshot one and snapshot two, then we have one case. This is like a person with good color vision, looking at a red marble beside a black marble. That observer clearly

distinguishes the marbles, and to him they do *not* appear identical. Every time he looks again, they still differ because he did not change his decision algorithm between looks. On the other hand, a color-blind observer cannot distinguish the marbles, and to him they are seen as identical. Every time he looks, they are seen as identical, because his identity decision algorithm did not change.

Or, suppose a proponent argues that the "rightness" or "leftness" of the dividing line L, between A and  $\bar{A}$  in the Venn diagram, can be taken into account. He is actually invoking a different algorithm (it belongs to the left and therefore to A) in one time snapshot than the algorithm (it belongs to the right and therefore to  $\bar{A}$ ) used in the other time snapshot. So his right side and left side of a line implicitly invokes the very point we are making: *the algorithm utilized is a variable and must be accounted.*

The point is this: *identity — whether in perception, thought, or observation — is not absolute, but depends upon the precise nature of the operation of the perception, thought, or observation process utilized and specifically on the "decision algorithm" used for "determining" identity or nonidentity.*

For example, two antennas certainly "see" quite differently, if one is a VLF (very low frequency) antenna and the other is an IR (infrared) antenna! As another example, two observers in different frames may see a particular object as quite different observed things! In n-space, an observer in a frame at right angles to the lab frame, will see any mass in the lab frame as a wavefront going at light speed; in short, as a photon or photonic object, whereas the observer in the lab frame will continue to see it as just a common old mass object. So the "same object" *physically* differs to the two different observers, according to their frame of reference. An observer whose frame is rotated by three orthogonal rotations from the lab frame, will see that object as an "object existing in time only," i.e., as simply a sort of "thought" image, so to speak. To be more scientific, he may assign it to something called the "virtual state".

In short, we can violate any and all of the laws of Aristotelian logic, because identity per se is *perceived, thought, or observed* identity — the output of a variable decision algorithm — and is not absolute.

For clarity, we add a fourth law that violates all Aristotle's three:

$$A_1 \sum_3 \bar{A}_{(2)} \quad [11]$$

All this really says is that, in time 3, the decision algorithm being used was changed from what it had been in times 1 and 2, and now could not distinguish between what was seen in snapshot 1 and what was seen in

snapshot 2, even though to some "ultimate" observer the two were distinctly different.

In addition, we say that it "implicitly includes" the negations of all three Aristotelian laws. We then add an "application rule" (or a fifth law, as one wishes) as follows:

$$\{ [(A_1 \sum_3 A_2) \Rightarrow \wedge (A_1 \neq_3 A_2)] \Leftrightarrow \}_5 \vee \{ [(A_1 \sum_3 A_2) \Leftrightarrow \wedge (A_1 \neq_3 A_2)] \Rightarrow \}_5 \quad [12]$$

This winds up producing an extension of Aristotle's logic, so that the following explicit laws emerge:

$$A_1 \sum_3 X_{(2)} \heartsuit A_1 \sum_3 A_{(2)} \quad [13]$$

$$A_1 \neq_3 X_{(2)} \heartsuit A_1 \neq_3 \bar{A}_{(2)} \quad [14]$$

$$A_1 \vee_3 \bar{A}_{(2)} \quad [15]$$

We also have the exact opposites of those three laws implicitly. The opposites can all be congealed into a single fourth law:

$$A_1 \sum_3 \bar{A}_{(2)} \quad [16]$$

To make sense of these, we also have the master application rule or 5th law:

$$\{ [(A_1 \sum_3 A_2) \Rightarrow \wedge (A_1 \neq_3 A_2)] \Leftrightarrow \}_5 \vee \{ [(A_1 \sum_3 A_2) \Leftrightarrow \wedge (A_1 \neq_3 A_2)] \Rightarrow \}_5 \quad [17]$$

We prefer to refer to this extension as a "four-law logic", where equations [13], [14], and [15] are the normal "explicit" laws, with the implicit law [16] understood but not explicitly written, and where equation [17] is the master application rule that puts it all together. But if one wishes to be rigorous, we have specified a 5-law extended logic that contains but expands Aristotle's 3-law logic. The application rule is the fifth law.

The point is this: In every case, we have a part of the perception, thought, or observation that obeys the explicit laws, and we also have a part that obeys the implicit laws. If opposites are not *explicitly* identical, then they

are simultaneously *implicitly* identical. If opposites are *explicitly* identical, then simultaneously they are also *implicitly* not identical.

The new approach then covers what we observe more completely. As an example, any "wave" (observed) is implicitly a non-wave (particle), but not observably so. If its particle nature is observed and therefore explicit, its wave nature is unobserved and therefore implicit, and vice versa.

One also resolves such dilemmas as stating something "does not exist" but having to first call it into existence to even state it does not exist. In the new approach, it simply does not *explicitly* exist, but *implicitly* exists. *Not-being* is something like that: explicitly it doesn't exist, but implicitly it exists. The great problems of the philosophers were never solved, mostly because the logic brought to bear was Aristotelian and incomplete. The ultimate answers they sought all involved the fourth and fifth logic laws. So the ultimate answers all appeared to them to involve such things as "the accursed necessity for the identity of opposites." Precisely!

In physics, there has been the same problem over whether a fundamental particle is a particle or a wave. Physicists argued fiercely until they realized the futility of further argument, and settled for the duality principle. That simply states, well, in one case it can be a particle as observed in your experiments, and in another case it can be a wave as observed. So simply treat it as whichever one is useful! The philosophers, on the other hand, split into different schools, where each school had its "interpretation" usually involving a very "smooth" position statement of the school's position. In physics also, there are eight or more "interpretations" of quantum mechanics, for example. So the same centuries-old problem is still with us today in modern physics.

Opposites are no longer the formidable opponents they once seemed. Instead, they become more like the two sides of a coin, lying with only one side up. To see heads or tails is to decide which is explicit. The other is always there, implicitly. But notice also that the "two sides" require a 3-dimensional object, and not just the 2-dimensional "head" or the 2-dimensional "tail". This juxtaposition of "identical" opposites is strongly met with in modern physics. For example, quoting Lee<sup>33</sup> :

---

<sup>33</sup> T. D. Lee, "Space Inversion, Time Reversal and Particle-Antiparticle Conjugation," *Physics Today*, 19(3), Mar. 1966, p. 23. Positive charge is really *observation* imposed on negative charge moving backwards in time, and the positron is really observation imposed upon an electron traveling backwards in time, etc.

*"As we expand our observation, we extend our concepts. Thus the simple symmetries that once seemed self-evident are no longer taken for granted. Out of studies of different kinds of interactions we are learning that symmetry in nature is some complex mixture of changing plus into minus, running time backward and turning things inside out."*

Any addition to the Aristotelian laws of logic is actually a higher dimensional form of it. Three-law Aristotelian logic is in fact fitted to primitive observation — the result or output of single-photon interaction and observation processes.

This "four-law" logic (or "five-law" logic if one includes the master application rule as another "law") has proven very useful over the years, particularly in bioenergetics applications. It has also been most useful in attempting to decipher that branch of Russian energetics weapon science called "psychoenergetics", and in attempting to decipher the mind-body coupling mechanism, but that is beyond the scope of this chapter {79}.<sup>34</sup>

#### **1.4.5 Substitution of Effect for Cause**

Refer to Figure 1-3 again, to see the relationship of the unobserved cause, the interaction of cause and a previous effect, and the production of the resulting "new effect" as a change to the old effect or the output of a second replica of it. The greatest non sequitur in electrodynamics — and in parts of physics such as mechanics — is the widespread substitution of the *effect* for the *cause*, as a result of considering an observable to *persist in time* without any physical interaction. We discuss that more fully in Chapter 2, particularly with respect the notion of the same EM field existing both as a component of a material environment and as a component of a nonmaterial environment, but with the "force reducing to zero" in the latter. Jackson {80} points out the prevailing view of electrodynamicists as follows:

*"Most classical electrodynamicists continue to adhere to the notion that the EM force field exists as such in the vacuum, but do admit that physically measurable*

---

<sup>34</sup> The interested reader is referred to my website, [www.cheniere.org](http://www.cheniere.org), for papers dealing with the nature of the mind-body coupling mechanism and the body-mind coupling mechanism, as well as direct engineering of the mind, and limited information on the weapons referred to.

*quantities such as force somehow involve the product of charge and field."*

On the other hand, Bunge {81} very clearly stated that the standard electrodynamics and physics itself are in terrible shape. Here is a direct quotation:

*"... the best modern physicist is the one who acknowledges that neither classical nor quantum physics are cut and dried, both being full of holes and in need of a vigorous overhauling not only to better cover their own domains but also to join smoothly so as to produce a coherent picture of the various levels of physical reality."*

We shall try to further clarify these unresolved difficulties with the field concept in Chapter 2.

## **1.5 Electrodynamics is Still Developing**

### **1.5.1 Statement by Penrose**

Roger Penrose, one of the leading physicists of our time, pointed out the still-developing nature of electrodynamics with respect to the developments from conventional gauge-theoretic interpretation of Maxwell's equations. Quoting Penrose {82}:

*"These facts should not, however, deter theoretical or experimental physicists from seeking alternative descriptions, unconventional formulations, surprising electromagnetic effects, or radical generalizations. The various articles in this book provide the reader with a great variety of different kinds of approach to developments of this nature. We have historically motivated accounts, suggestions for new experiments, unconventional viewpoints and attempts at generalizations. We also see novel and ingenious formulations of electromagnetic theory of various different kinds... I am sure that this book will make it clear that electromagnetism is a subject that is in no way closed to stimulating new developments. It is very much alive as a source of fruitful new ideas."*

### 1.5.2 An Example of a Ubiquitous Error

One of the rather horrid "bad examples" of ubiquitous errors in electrodynamics is the conventional illustration of a so-called planar EM wavefront moving through space, as shown in Figure 1-4.

A succinct evaluation of that diagram and notion is given by Evans {83}, one of the great electrodynamic theoreticians of our times:

*"I broadly agree ... that the transverse plane wave view of vacuum electrodynamics is the biggest blunder of twentieth century science."*

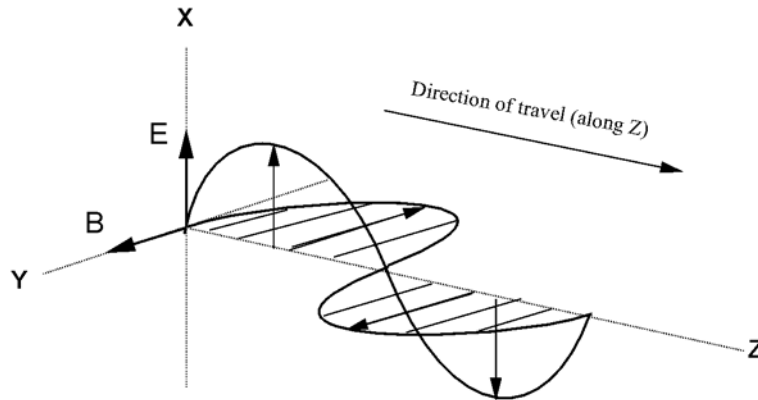

Figure 1-4 The erroneous but ubiquitous supposed illustration of the transverse EM wave in 3-space.

Dr. Robert H. Romer, former Editor of the *American Journal of Physics*, also chastised the horrid diagram shown in Figure 1-4, purporting to illustrate the transverse plane wave traveling through 3-space. In endnote 24 of his noteworthy editorial, Dr. Romer {84} takes that diagram to task as follows:

*"...that dreadful diagram purporting to show the electric and magnetic fields of a plane wave, as a function of position (and/or time?) that besmirch the pages of almost every introductory book. ...it is a horrible diagram. 'Misleading' would be too kind a word; 'wrong' is more accurate." "...perhaps then, for historical interest, [we*



*should] find out how that diagram came to contaminate our literature in the first place."*

Indeed, each point along the z-axis, is a momentary "3-space frozen slice" of the  $\epsilon/\epsilon t$  operator being applied to the ongoing 4-space interaction of the causal field in 4-space interacting with the previous "observed effect" (in this case, the previous 3-space slice) to produce a change to it. So the entire diagram is a set of "frozen 3-space observations", in which nothing at all is moving, and where the fields shown are in the mass (detecting/observing) medium. There is no such thing as a "traveling EM wave in 3-space", because "moving" or "changing" or "traveling" *a priori* must involve time as well as 3-space. What we are looking at in Figure 1-4 is the iterative and very rapid results of continual "3-space observations" (frozen 3-snapshots) of an on-going 4-space interaction.

### **1.5.3 An Extremely Important EM Omission**

There is an enormous amount of development yet to be done in electrodynamics! As a simple example, for nearly a century there has been waiting quietly a fundamental "internal" or "infolded" electrodynamics by Whittaker {85, 91a, 86}, based on more primitive initial work by Stoney {87}, existing inside — and *comprising* — all conventional EM potentials, fields, and waves. This internal electrodynamics {88} has been essentially ignored in the West, but has already been weaponized in the weapons laboratories of several nations under the aegis of *energetics*. The U.S. Secretary of Defense, Secretary Cohen {89}, alluded directly to some of these weapons in a speech in 1997 as follows:

*"Others [terrorists] are engaging even in an eco-type of terrorism whereby they can alter the climate, set off earthquakes, volcanoes remotely through the use of electromagnetic waves... So there are plenty of ingenious minds out there that are at work finding ways in which they can wreak terror upon other nations...It's real, and that's the reason why we have to intensify our [counterterrorism] efforts."*

The weapons are already being utilized against various nations in the form of terrorist acts in an undeclared war {89}, and have been so used since the 1950s.

This internal longitudinal-wave EM and its dynamics is a much more fundamental electrodynamics (actually a subset of a unified field theory) consisting of correlated longitudinal EM wavepairs in both the 3-space and time domains. Each Whittaker decomposition wavepair is comprised of an

incoming longitudinal wave — a "time-polarized" EM wave {90a-90c} — in the time domain, perfectly correlated with an emitted longitudinal EM wave in 3-space. See Figure 1-5. This multiwave structuring and dynamics in both the time domain and in 3-space simultaneously *comprises* the scalar potential.

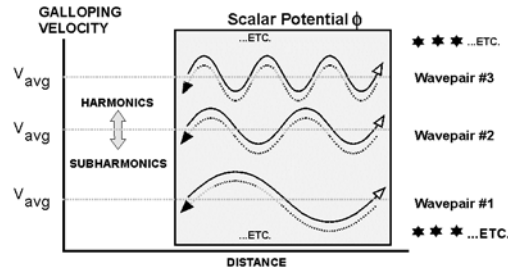

**The Structure Is:**

- A harmonic set of longitudinal phase conjugate wavepairs.
- In each wavepair the two waves superpose spatially after detection, but travel in opposite directions.
- Prior to detection, the convergent wave set is in the imaginary plane, and hence is not observable. It is EM energy incoming to the potential (dipolarity) from the time domain.
- The charges receive the complex convergent EM energy, transduce it into real EM energy, and emit enormous energy at the speed of light in all directions — which includes bidirectional pairs in 3-space (after the reaction, being after "observation").
- This produces the fields and potentials from the "source charge or dipole."
- Mandl and Shaw argue that the scalar (time-polarized) photon and longitudinal photon are observable only in similar pairs, which then makes the instantaneous scalar potential. Thus quantum field theory work strongly supports the "negative resistor" interpretation of the scalar potential and our solution to the source charge and source dipole problem.

**Figure 1-5 The scalar potential is a harmonic set of phase conjugate longitudinal EM wavepairs.**

We specifically stress that the dynamics occur in the *time* domain (in its specific structuring, propagation pace, etc.) as well as in 3-space.

Deliberately changing the internal longitudinal EM wave structuring produces precise energetics (both energy and dynamics) in spacetime itself. This is a special form of "spacetime curvature structure and dynamics" which we call a *spacetime curvature engine* or *vacuum engine*. Together with superpotential theory in the original form initiated by Whittaker {91a} and extended by others {91b, 91c, 91d}, this internal electrodynamics — together with scalar potential interferometry {92} — creates all ordinary EM fields and waves {79}. Superluminal communication is possible using the internal longitudinal EM wave structure of the EM fields, potentials, and waves {93a, 93b}.

## 1.6 A Summarizing Letter

Our thrust in this book is to attempt to (1) reveal some of the major flaws in electrodynamics that have prevented development and use of COP>1.0 electrical power systems, and (2) point the way toward the development and use of such systems. To give a general summary of the ground this book will cover, we conclude with an informal E-mail letter I sent to the recent editor of *American Journal of Physics*, pointing out the greater implications of his cogent observation of that "dreadful diagram" and where it leads. Indeed, it (i) leads to a dramatic change in electrodynamics, (ii) changes the way in which we regard "propagation of EM energy through 3-space", (iii) solves the long-vexing problem of the association of the source charge or source dipole with its fields and potentials and their energy, (iv) changes dramatically the way we view what powers an electromagnetic circuit or power line, (v) allows extraction and use of copious EM energy from the vacuum, and (vi) solves the energy crisis permanently.

Here is the letter sent informally to Dr. Robert H. Romer — *slightly edited* to improve the grammar, correct one error of misstatement, and with reference citations added and listed at the end of this chapter:

-----

|                             |                        |
|-----------------------------|------------------------|
| To: Dr. Robert H. Romer     | Thursday, Mar. 8, 2001 |
| American Journal of Physics |                        |
| Amherst College, Box 2262   |                        |
| Amherst, MA 01002           |                        |

### Personal communication

Subject: Implications of your cogent comments on that atrocious illustration

Dear Dr. Romer:

This is not a submission of a manuscript, but a personal communication to you on a matter of great importance in physics, directly related to endnote #24 of your seminal editorial {94}.

It will take a little exposition, so please bear with me and read this when you have the spare time to do so. We are going to show you how your keen insight can be extended to solve some extraordinarily formidable

foundations problems in present electrodynamics. We will also show how to apply the implications of your insight to totally solve the present electrical energy crisis permanently.

In your endnote #24, {94} you took to task (quoting):

*"...that dreadful diagram purporting to show the electric and magnetic fields of a plane wave, as a function of position (and/or time?) that besmirch the pages of almost every introductory book. ...it is a horrible diagram. 'Misleading' would be too kind a word; 'wrong' is more accurate." "...perhaps then, for historical interest, [we should] find out how that diagram came to contaminate our literature in the first place."*

Dr. Romer, you have lifted the corner of a dark cover concealing one of the most important flaws in electrodynamics and in fact in all of physics: the unwitting and pervasive substitution of the effect for the cause. A marvelous extension to the present physics is enabled if one removes this terrible non sequitur in physics, and particularly in electrodynamics. For openers, one solves what has been called the most difficult problem in electrodynamics (the problem of the source charge and the association of its fields and potentials and their energy) {100}. I will solve that problem for you in this informal write-up. I will also explain how to extract enormous EM energy from the vacuum, anywhere and anytime, easily. Extracting it is easy; catching it and using it to power loads without killing the extraction process is another matter.

One also gets a unified field theory, engineerable by novel electrodynamic means, as is steadily being shown by a series of rigorous Alpha Foundation's Institute for Advanced Study (AIAS) papers published in various leading journals (and more than 90 of them carried on a Department of Energy website restricted primarily to DoE scientists). Dr. Myron Evans, Director of the AIAS, has over 600 papers published in the literature, including such journals as *Physical Review*, *Foundations of Physics*, *Physica Scripta*, etc. Many of the other AIAS co-authors are excellent theoreticians and scientists.

The early pioneers of electrodynamics (Maxwell etc.) all assumed a material ether filling all space {95}. To these early scientists, there was not a single point in the entire universe that was devoid of matter, because the ether was present there. Hence their outlook as to the nature of EM fields etc. was quite material. Faraday conceived his "lines of force" as physical, taut strings, so that perturbations were "plucking these taut strings".

Maxwell himself points out in his famous "Treatise" that he specifically captured the thinking of Faraday in his theory. In fact, Maxwell wrote a *material fluid flow dynamics* theory.

In the light of more modern knowledge, let us see the impact of these and similar early *but still retained* erroneous electrodynamics assumptions.

First, observation/detection is totally spatial, as is well known in quantum mechanics. In fact, observation is a  $\epsilon/\epsilon t$  operator imposed upon 4-space (LLLT spacetime), yielding a frozen instantaneous snapshot LLL of an ongoing 4-space dynamic process. At the next instant, that particular *previous* observation no longer persists. Why?

Well, no observable *persists*, since it is only an instant frozen 3-space snapshot, at a single point in time, *a priori*. Here again we have another horrendous non sequitur in all of physics: the assumption that observables "continue to exist" and therefore persist in time in a passive manner. In fact, there is an interactive process that generates their (seeming) persistence, involves time, and continually changes mass into masstime and back to mass, etc. With the reader's permission, we will pass discussing that mechanism until another time (pun intended!).

What we conceive as "an observable such as mass, traveling through space and persisting in time while doing so", is actually an iterative, continual series of these frozen 3-space snapshots or observations, much like the frames of a motion picture film. We ourselves mentally add the "continuity" to provide "the sensed motion", but rigorously what is actually "observed" is not continuous, but is a vast continual series of those frozen 3-space snapshots.

We're getting directly at that atrocious diagram!

Each snapshot is an *effect*, not a cause, because it was the output of the observation process whereby a 4-space *causal* entity (non observed *a priori*) interacts with a previously observed frozen entity (say, a unit point charge at some point in space) to produce the observation (change or effect generated in that interacting observed charge) as the "next instantaneous observation".

The usual "representation" of a "3-space EM wave" propagating in 3-space is indeed atrocious, just as you stated! It is actually just an iterative succession of such instantaneously frozen snapshots in 3-space, one after the other. There is no such thing as that set of snapshots independently existing in spacetime, *prior to interaction with charge* in that series of

interactions and observations, unless we wish to discard quantum mechanics and the laws of logic.

There is, however, a continual iterative stream of those observations — those frozen 3-space snapshots — that we interpret (erroneously) by recall from memory as the "EM wavefront propagating in 3-space". As you eloquently pointed out, that is not so, and it is atrocious. An observation, being an absolutely frozen entity, cannot "move through time" anyway, since it cannot persist, nor can it move. A change to an observable can only be another observable snapshot of the ongoing 4-space entity and action, which is then compared to the first snapshot and a difference noted {96} [See Figure 1-3].

In short, a great stream of "frozen effects" (frozen instant observations) does not constitute a "picture" of the ongoing 4-space action, but only a series of frozen 3-space intersections involving the interaction of that fixed observed (3-space) charge with the ongoing causal 4-space entity. If we add and integrate a series of 3-space pieces, we *do not* get a 4-space entity! Instead, we get a longer or bigger 3-space slice/piece, but one for which each piece of it only existed at a single point in time as a 3-space "slice" at that moment. That is precisely what is wrong with that horrible illustration.

But it is also "wrong" with electrodynamics itself! Electrodynamicists mistakenly conclude that the same *effect* "series of static 3-slices" — which they might call, e.g., the "field" in a case where the field is the subject — is the same as the 4-space continuous *causal* field prior to observation interaction with charge at all. Well, LLLT is definitely not LLL, nor is it  $n(\text{LLL})$  where  $n$  is some large but finite number of 3-slices LLL.

So the field concept is dichotomously used in two contradictory manners in electrodynamics:

(1) it is considered to be in 4-space prior to the observing/detecting interaction with the observable (such as a unit point 3-space charge), and it is also considered a 3-space entity *after* that interaction. The dimensions of the two entities are not the same, and neither are the dynamics. The causal EM wave is dynamic and 4-spatial, the effect "3-space EM wave" (ugh!) is static and 3-spatial at each instant it is "observed". Assuming that the two are the same thing is a non sequitur.

In fact, it substitutes the *effect* for the *cause*, a rather gross violation of the causality principle itself.

(2) then an attempt at glossing over the illogic is used by the smooth statement that "the field (meaning that atrocious series of frozen 3-space snapshots) remains in the absence of charge, but the force goes to zero." Well, if the field is defined as a force field, it cannot be a "non-force field in the same observation!" Else, opposites are always identical.

So of what importance is all that?

It is of great importance. Let me show you one very startling thing that comes out of correcting this "biggest foundations non sequitur in physics, that of substituting the effect for the cause".

Consider a very special paper by E. T. Whittaker {97} in 1903. [I can send you a pdf file of the paper if you do not have it and are interested]. In this much-neglected paper, Whittaker decomposed the so-called "static" potential into a harmonic set of bidirectional longitudinal EM wavepairs, where each pair consists of a longitudinal 3-space wave (an *as-observed* wave) and its longitudinal phase conjugate wave (*considered unwittingly as having also interacted with charge, and therefore as being shifted into 3-space as an "as-observed" wave with inverse parity*).

Whittaker — as has everyone since him — unwittingly assumed the "iterative continual observation" interaction in there for the phase conjugate wave also. In so doing, he came up with two *effect* "waves" that are the outputs of the assumed observation process. Neither of these effect waves would be a wave in spacetime {98} at all, but the two in ensemble are an example of the same thing you objected to in your cogent commentary on that abominable "illustration".

In short, Whittaker invoked *observation* as a process with two effects and no cause, rather than with a cause and an effect, with the interaction with the observing/interacting unit point charge being assumed for both waves. Whittaker and everyone since seem to have made the same error in interpreting that seminal Whittaker decomposition. This misinterpretation of the decomposition has until now hidden one of the greatest secrets of all times in Nature's electrodynamics!

Let us correct the interpretation, and uproot that great secret to the light of day.

First, for observation to occur, one must have a cause acting upon the affected (observable) entity, and an effect (observable change) must be produced in, on, or of that affected (interacting) entity. One *must not* have two effects (two observables) and the affected entity (another observable and therefore another effect)! Again, assuming that one has three effects

(observables) constituting the observation process is a logical non sequitur of first rank.

Let us now correct that logical non sequitur made by Whittaker and other physicists and electrodynamicists, and see where it leads us.

First, we go to particle physics, where broken symmetry {99} was discovered in the 1950s. Lee, e.g., received a Nobel Prize for his work in that area {75}. Lee also showed that any dipole is a broken 3-symmetry in its violent energy exchange with the active vacuum.

Well, a scalar potential is a dipolarity; always a potential is actually a difference between two potentials, so to speak. So the potential itself represents a broken 3-symmetry in an energy flow exchange with the active vacuum.

Let us further examine that interesting broken symmetry aspect. It means that the "static" potential is a process whereby energy is received from the vacuum in *one* form, not observable, and hence unusable, but is output in *observable* (usable) form. In short, the dipolarity or dipole receives and absorbs (QM view) virtual photons, integrates them into observable magnitude, and emits real, observable EM energy ("continual observation" snapshots of the latter being assumed).

In physics, all observation is 3-spatial, as is well known. And 3-space is the realm of the observed. The EM energy from the vacuum is not received in 3-spatial (observable) form, else there would be no broken 3-symmetry of the dipolarity.

We can also *experimentally* verify that there is no 3-space input of EM energy to the potential — e.g., to the potential between the ends of any source dipole, because we cannot measure any 3-space observable energy feeding the charges of the dipole. Instead, observable 3-space energy is continuously pouring out of the dipole.

Let us continue now with the notion of a real dipole of separated source charges, with our "scalar potential" between its ends, so we have something concrete in mind.

First, our instruments prove there is a continual emission of EM energy in all directions in 3-space (of the kind in that atrocious diagram; a "series of iterative film-snapshots"). That is the way it is conventionally represented, as if observed at each and every point successively in that 3-space, and along every radial.



But secondly, our instruments also prove there is no such observable *input* of EM energy in that same 3-space *to* the dipole. Bummer! That is precisely what has stopped electrodynamicists from solving that vexing problem of where all the energy pouring out of the source dipole is coming from, and how! They unconsciously assume that the only possible source of the EM energy input is in 3-space. That is totally wrong. Further, the conservation of energy law does not require that energy be conserved in 3-space! Instead, rigorously — if we are using a 4-space (i.e., spacetime) model — it requires that energy be conserved in 4-space. The assumption of the extra condition of 3-space energy conservation is an added and arbitrary extra condition.

Since electrodynamics has not resolved this "source dipole and its associated fields and potentials" problem, it has stopped work on the problem and implied that every dipole in the universe is a perpetual motion machine, freely creating all that EM energy it continuously pours out across space, in all directions, creating its associated fields and potentials. That implicit assumption, if true, of course destroys the conservation of energy law.

It isn't true, and the energy conservation law is alive and well!

We can experimentally prove that the source dipole *does* continuously pour out energy in all directions in 3-space, without ceasing, as follows:

In a gedanken experiment, we set instruments every 300 million meters or so, along a radial line from an origin in the lab. With the instruments and clocks synchronized, we suddenly form a dipole at the origin. One second later, the first instrument reads. A second later, the second instrument reads. And so on. But it is not a "passing pulse". Whatever reading the instrument makes as the forward edge of the energy flow reaches it, is then continuously maintained thereafter. This proves that the energy is poured out continuously and at the speed of light, and in any (and all) directions in 3-space, *and it continues to pour out at exactly the same rate so long as that dipole remains intact.*

Dipoles in the original matter of the universe have been pouring out EM energy in that fashion for some 14 billion years, and they have not "exhausted" their unobserved energy input source yet.

A newly formed simple dipole, e.g., in one year will have poured out energy into a spherical volume of space that is a light-year in radius. Wait another year, and that volume of space whose energy density has been

changed will be two light years in radius. The dipoles in the original matter have filled the universe itself with that energy outpouring from them.

In other words, an incredible amount of EM energy has been and is being poured out into space from every dipole in the universe.<sup>35</sup> And electrodynamicists have had not the foggiest notion of where that mind-boggling amount of outpoured EM energy has come from.

Unless we wish to totally discard the conservation of energy law, we must have an equal input of energy *from outside 3-space*, going into every dipole continuously. In 4-space, that only leaves the fourth axis, along which and from which the input energy must move into the dipole.

And so it does. If we re-interpret that phase conjugate half set of the Whittaker decomposition, *before* observation has occurred, it then is a harmonic set of longitudinal EM waves moving in the time-dimension, *into* the source dipole (parity is not inversed because no interaction with charge has occurred to shift it into 3-space).

So voila! We have strangely (but quite rigorously) solved what Sen {100} referred to in this manner: *"The connection between the field and its source has always been and still is the most difficult problem in classical and quantum electrodynamics."*

We express our reasoning as follows: (i) we know from particle physics that the source dipole<sup>36</sup> is a broken 3-symmetry in its flux exchange with the vacuum. This means that we know the energy is received from the vacuum in an *unobservable* form, absorbed by the dipole, and emitted as *observable* EM energy. It remains to translate that into classical electrodynamics rather than quantum physics {101}. (ii) The *time* domain is the only domain outside 3-space, in the standard 4-space model. (iii) Anything in the time domain exclusively, is indeed nonobservable, since the  $\epsilon/\epsilon t$  observation operator destroys time and all its internal structure and dynamics whenever observation occurs. (iv) Looking for a "3-space" input is looking for an "observable" EM energy input, which would in fact disagree with the known broken 3-symmetry of the source dipole.

---

<sup>35</sup> Later we will see that, in a time-forward situation, the negative charge pours out positive EM energy while the positive charge may be said to pour out negative EM energy. Charge conservation then implies that an energy balance is maintained overall.

<sup>36</sup> Because of the broken symmetry of the opposite charges on its opposing ends.

Let me digress now to speak of fundamental units. As is well known, the fundamental units one chooses to make his physics model represent an arbitrary choice. One can, if one wishes, make a perfectly valid (but mentally nightmarish!) physics using only a single fundamental unit. In that case, all other "fundamental units" in the present model become functions of that single fundamental unit.

Suppose, e.g., that we make the joule our only fundamental unit. Then "mass" becomes totally a function of energy — and we have no heartburn with that one since the Einstein revolution and the nuclear age. But then "time" also becomes totally a function of energy — and that surprises us, because we have unconsciously been taught (erroneously) that "time is a flowing river down which a mass drifts like a drifting boat". That is not the nature of time at all; the totality of the photon interactions with a mass create that mass's "motion through time". I can later explain that to you also, if you wish, but let us pass it for now.

It turns out that time is spatial energy compacted by the factor  $c^2$ , so it has the same energy density as mass, but in the time axis instead of 3-space. Intuitively, if we are interested in cause and effect, the energy of the cause (time) should be equal to the energy of the effect (in this case, mass). After one reflects a moment, one also sees that "time energy" is required to "drive" a mass through time, just as "spatial" energy is required to "drive" a mass through space. The notion that mass in an inertial frame moves through "empty space with no reaction" is false; it continually moves through the energetics of spacetime, and interacts continuously with it.

Anyway, from still another viewpoint there is no magic in EM energy currents moving in the time domain! Quantum field theory already recognizes multiple polarizations of the photon, including transverse, longitudinal, and time-polarized. Thus, it implies a time-polarized EM wave also. A longitudinal EM wave *moving in the time domain* oscillates along its line of travel. That is indeed oscillating its energy density in the time domain, so that it is "time-polarized". Hence it is a proper time-polarized EM wave, and appears to "gallop" {102} or vary its speed periodically.

The solution to the "source dipole" problem is that the phase conjugate wave half-set of the Whittaker decomposition, when reinterpreted, is the *incoming* EM energy in the time domain, continuously input to the charges of the dipole. The charges interact in the imaginary plane (the time domain), and absorb the time-energy, then transduce it into 3-space, and emit it as Whittaker's set of real observable longitudinal EM waves in all

directions in 3-space (as observed). The time-energy waves that are input to the dipole cannot be observed, since observation destroys time and its constituents.

All 3-spatial EM energy comes from the time domain! Broken 3-symmetry of the source dipole immediately releases our arbitrary additional restriction on nature's energy conservation law — i.e., our insistence that the energy input for conservation must be input in 3-space. By removing these arbitrary "shackles" from nature's feet, we allow nature to joyously resume her much-preferred special 4-symmetry in EM energy flow: the circulation of EM energy from the time domain into 3-space, and outpouring of that energy in all directions in 3-space, at the speed of light {103}.

Now let us solve the source-charge problem as well. That one is now easy to resolve.

We know from quantum mechanics that any "isolated" observable charge is actually clustered around by virtual charges of opposite sign. So we simply take one of these clustering opposite charges while it exists, and a differential piece of the observable charge, and we have a composite dipole. Hence the "isolated charge" may be represented as a grouping of such momentary dipoles, each (while it exists) with a scalar potential between its poles, and hence each subject to the same decomposition and reinterpretation we have done.

That is why the source charge can "sit there" and pour out EM energy in 3-space (as observed) continuously, and indefinitely. It is also continuously absorbing EM energy from the time domain. As a set of composite dipoles, it is a set of broken 3-symmetries in EM energy flow. Hence it exhibits nature's preferred 4-symmetry in energy flow, between the time-domain and 3-space.

Note also that, to the 3-space observer, this 4-symmetry is purely negentropic. It is a continuous and ongoing (and expanding) reordering of the vacuum energy, in the form of the reinterpreted Whittaker decomposition.

We can easily engineer negentropy! Just make a little dipole, and nature happily starts pouring out energy and reordering part of the vacuum, with that reordering spreading at the speed of light, steadily increasing all the while.

Reinterpreting Whittaker's marvelous decomposition tells us many things: (i) the source charge or dipole does indeed continuously receive and

absorb its input energy from the time domain, (ii) it continuously transduces its absorbed energy to real 3-space energy (as observed!), and (iii) it continually outputs its absorbed and transduced time-energy as 3-space energy emitted in all directions in 3-space (as continually observed).

So the terrible foundations problem of the source charge and source dipole is resolved, and the energy conservation law is maintained.

We have also uncovered a most important thing: Given a little broken 3-symmetry in EM energy flow, t-symmetry in EM energy flow is also broken. A more primary 4-symmetry {104} between time-energy flow and 3-space energy flow emerges *automatically*. In short, every potential, every dipolarity, and every charge is such a broken 3-symmetry and an example of the new, preferred 4-symmetry of EM flow, with input flow in the time-domain (nonobservable!) and output flow (as continually observed in a series of 3-snapshots) in all directions in 3-space.

This also resolves the logical cause and effect problem for observation.

This 4-symmetry is a purely negentropic process, once the dipole is established! Well, we should have known that from the gauge freedom axiom in gauge field theory anyway! That axiom says that we can change the potentials anytime, freely and at will. In electrodynamics, that means we can change the potentials at will, anytime we want to. But that means *we can freely change the potential energy of a Maxwellian system at will, whenever we wish*. It costs nothing — at least in theory; in the real world we have to pay a little for switching — to suddenly potentialize an EM system, prior to the time the Drude electrons relax and current flow begins.

I have applied this great new 4-symmetry in EM energy flow, that is freely evoked and persists indefinitely after one pays a little to make the dipole and thus produce a little broken 3-symmetry, to produce EM energy freely from the vacuum. Without going into it, I refer you to our forthcoming papers {105}. Indeed, we can use this negentropic process to extract as much EM energy from the vacuum as we wish, anywhere, anytime, for peanuts. Let us now move to discuss that area.

First, we point out another astounding result that comes from resolving this "source charge and source dipole" foundations problem.

Generators do not use any of the shaft energy input to them — even in transduced form — to power their external circuits! A generator itself does not add a single watt to the power line, and neither does a battery's chemical energy dissipation add a single watt to its attached circuit.

Neither does burning all those hydrocarbons, consuming all those nuclear fuel rods, building all those dams, etc. to provide our conventional power systems and grid. None of that enormous destruction of the biosphere and pollution of it has ever directly produced one watt on the electrical power line.

Just follow the energy flow, in light of what we now know. Here's how it works.

Typically, we burn some fuel to boil water and make steam, and use the steam to power a steam turbine, which forcibly rotates the shaft of the generator, thereby inputting mechanical shaft energy into the generator. So far, so good. That took care of all the hydrocarbon burning and fuel rod consuming, extracting and transporting the oil, etc.

This input of the shaft energy forcibly rotates the rotor against internal resistance, forming an internal magnetic field. Assuming a 100% efficient generator with no internal losses whatsoever, this means that the *mechanical shaft energy input* has now been totally transduced into *internal magnetic field energy*.

So what does that magnetic field energy *do*? It is totally dissipated upon the internal charges of the generator, performing work on them and forcing the positive charges in one direction and the negative charges in the other direction. That dissipation of the energy in the internal magnetic field *forms a source dipole inside the generator, connected to the terminals*.

And that is all the generator does. Period. *None* of the energy transduced from that shaft input, went roaring out of the terminals and down through space outside the conductors of the power line. Not a single watt. So let us turn to particle physics to find out what happens next, because *it does not yet appear in the electrodynamics model, even though proven*.

The internal source dipole, *once formed*, is a great broken symmetry in the vacuum flux, as we discussed and as is well known in particle physics. But the proven and well-known vacuum interaction with the generator and the dipole charges is not even modeled in the classical EM theory used by the scientists and engineers to build electrical power systems — much less a *broken symmetry* in that active exchange! That's atrocious, since it's been proven in particle physics for nearly a half century, Nobel prizes awarded, etc. But the hoary old 137-year old Maxwell-Heaviside model, further curtailed by Lorentz symmetrical regauging, does not incorporate what has already been proven in physics. *It does not accurately model the situation as it is and as it is known to be*.

Let us continue.

Once that dipole is formed, it extracts *enormous* EM energy from the vacuum, and pours it out of the terminals of the generator, filling space surrounding those conductors of the attached external power line. It is a huge EM energy flow, trillions of times larger than what we account after Lorentz taught us to disregard almost all of it.<sup>37</sup>

Only the tiny little bit of that EM energy flow in space along and surrounding the conductors — the little "boundary layer" that skims down the surface of the conductors — will strike the surface charges in the conductors and get diverged into them to potentialize the Drude electrons and "power the power line and its circuits and loads". *All the rest of the giant EM energy flow in space surrounding the conductors, and generally parallel to them, misses that power line entirely and is just wasted.*

Check the original papers by Poynting {4a, 4b} and by Heaviside {5a, 5b, 5c}, who independently discovered the flow of EM energy through space (as if continually observed!) in the 1880s, after Maxwell was already dead. I can furnish the citations required. From the beginning, Poynting only considered that component of the energy flow that actually enters the circuit. He considered only the "boundary layer" right on the conductor surfaces, so to speak.

Heaviside considered that component that enters the circuit, and also uncovered and recognized the *gigantic* component in the surrounding space that *does not* enter the circuit but misses it entirely and is wasted. [Added] Here is Heaviside's {106} own statement:

*“It [the energy transfer flow] takes place, in the vicinity of the wire, very nearly parallel to it, with a slight slope towards the wire... . Prof. Poynting, on the other hand, holds a different view, representing the transfer as nearly perpendicular to a wire, i.e., with a slight departure from*

---

<sup>37</sup> However, contrary to what is in the textbooks,  $\mathbf{E} \Delta \mathbf{H}$  energy flow is not in observable EM field form  $\mathbf{E}$  and  $\mathbf{H}$  until it interacts with charge. Instead, the flow is in the form of virtual energy currents in the vacuum. We point out that the fields  $\mathbf{E}$  and  $\mathbf{H}$  utilized in the Poynting energy flow theory are effects and not causes. They are rigorously defined as  $\mathbf{E}$  and  $\mathbf{H}$  only after the causal 4-fields have interacted with charge. E.g.,  $\mathbf{E}$  is “defined” as force per unit point massive charge — i.e., as the force created by interaction of the “vacuum field” (curvature of spacetime) with a unit point charge. No unit point charge interaction, no force or force field intensity per interacting unit point charge.

*the vertical. This difference of a quadrant can, I think, only arise from what seems to be a misconception on his part as to the nature of the electric field in the vicinity of a wire supporting electric current. The lines of electric force are nearly perpendicular to the wire. The departure from perpendicularity is usually so small that I have sometimes spoken of them as being perpendicular to it, as they practically are, before I recognized the great physical importance of the slight departure. It causes the convergence of energy into the wire."* [End of Added].

But Heaviside had absolutely no explanation for the enormous and startling magnitude of this energy flow that "misses the surface charges of the conductors and is wasted". You can see an elementary illustration of the "point intensity" of this Poynting diverged energy flow component in Kraus {107}. Kraus's figure 12-59, p. 576 shows a good drawing of the Poynting component *being withdrawn* from the total EM energy flow filling all space around the conductors [see our Figure 1-1 in the present chapter].<sup>38</sup> Most of that available energy flow is not intercepted and thus not diverged into the circuit to power it, but just "wasted." The *remaining* huge component discovered by Heaviside is not shown on Kraus's diagram. Kraus's numbers on the contours represent the amount of power (watts per sq meter) being withdrawn from each contour, by the very limited axial movement of the electrons and the very ends of their associated fields into the wire.<sup>39</sup>

---

<sup>38</sup> The energy flow in space near the surface of the wires strikes the surface electrons and their fields, potentializing them and creating a force field with respect to inner electrons. This drives the surface electrons axially into the wire, since they can only move down the wire with the drift velocity, nominally on the order of a few inches per hour. The short inwards drawing of those small portions of the fields and of the increased potentials attached to the charges that move into the wires, interacts with the internal charges in the interior of the wire, powering the Drude electrons throughout the conductor and the circuit. For a discussion of the importance of the surface charges, see J. D. Jackson, "Surface charges on circuit wires and resistors play three roles," *Am. J. Phys.*, 64(7), July 1996, p. 855-870.

<sup>39</sup> Obviously the increased fields on the withdrawing surface charges reach toward infinity radially outward from the wire. Thus most of this increased field on a withdrawing electron remains outside the wire, radially reaching toward infinity, since the electron and its field cannot be withdrawn further than the diameter of the wire. As the surface charges and their fields change in Jackson's discussion, obviously those distant parts of the field remain outside the conductors. Hence there remains an extensive field and field energy outside the conductors and the circuits



So Heaviside {106} spoke cautiously of the *angles* and *relative directions* of the flow components; he did not wish to be scientifically destroyed for pointing out such an inexplicably large EM energy flow, far larger than the known energy input to the generator. There was then no such thing yet discovered as the electron, the atom, the nucleus, special relativity, general relativity, quantum mechanics, the active vacuum, etc. Poynting {4a, 4b} never even thought of the "nondiverged component that misses the circuit", nor did he consider it.

Lorentz, however, understood the extra Heaviside component and its vast magnitude, but he also could not explain it in any fashion. Even the great Lorentz could not risk publishing or advocating such an enormous energy flow, lest he be called a "perpetual motion nut" and destroyed. So he reasoned that, since that stupendous nondiverged energy flow component misses the circuit and powers nothing, it has "no physical significance" (his words).

Jackson in his famous 1975 *Classical Electrodynamics*, 2nd edition, uses essentially the same phrase {108a} as did Lorentz. And so do most other electrodynamicists.

So Lorentz {109} originated a little trick of integrating the energy flow vector itself around a closed surface surrounding any volume element of interest. Obviously, that zeros all *nondiverging* EM energy flows — including precisely that inexplicable and enormous Heaviside "dark energy" component. The integration trick does retain that small, *diverged* Poynting component that enters the circuit. In addition, our instruments measure energy dissipation from the circuit, and the energy has to *enter* the circuit to *be dissipated* from it. So our instruments and their measurements will indeed agree with the Poynting energy flow component. Lorentz thus arbitrarily discarded accountability of trillions of times as much EM energy flow as was retained and accounted.

In a later book by Lorentz, one can see that little trick {109} that is still used by electrodynamicists {110}.

---

that is never drawn into the wire. Additional separate receiver circuits with resistive loads, adroitly placed in this "externally remaining" field energy flow, can be made to intercept additional EM energy and will perform additional work in those external loads in the secondary circuits, separate from powering the loads in the primary circuit.

The Lorentz trick does not cancel the *actual* flow of the Heaviside dark energy component around every circuit! It just drops it from any accountability.

Indeed, we do precisely a similar thing for the "field" and the "potential". There is not a single text in the U.S. that calculates the magnitude of the *field itself*, prior to point interaction. Instead, we are taught to calculate the reaction of that field at a point in it, with a unit point static charge at that point. In short, we calculate *what is actually locally diverged from the field or potential by that little point static unit charge*, and call it "the magnitude of the field". At best, it is indicative of the field intensity at a point, because we have prescribed the magnitude of the static point charge's *reaction cross section* with the field, *not* the overall magnitude of the entire field itself. Another major non sequitur! By identifying the "field" as "that which is diverged from it", we gravely err. We do the same for the potential, again using its reaction cross section for a unit point charge at a point in the potential.

There is hardly a living electrodynamicist, it seems, who has calculated the magnitude of the field itself, or of the potential itself! All calculate the respective reaction cross section (and the *static* reaction cross section at that!) and erroneously call that the "magnitude of the field" or the "magnitude of the potential". It is no such thing. No thing filling all space is identical to a little something diverted from one point in itself, else we discard all logic.

Now we can return to our source dipole and its extraction of an *enormous* energy flow from the vacuum, once we account for the long-neglected (for more than a century) Heaviside dark (nondiverged, unaccounted) energy flow component. That is the essence of one of my papers {111}.

The easiest thing in the world to do is to extract enormous usable EM energy flow from the vacuum, *from the time domain*. Every circuit and every electrical power system already does it, and every electrical power system is powered by vacuum energy, *not* by burning all that coal, oil, etc. None of that does anything to actually power the circuit. It only makes dipoles.

If you will check the characteristics of the ubiquitous closed current loop circuit, you will discover a diabolical thing: that closed current loop circuit forces all the spent (depotentialized) electrons from the ground return line back through the source dipole (back through the back emf). It is easily shown that precisely half the energy *collected* in the circuit from that feeble Poynting energy flow component is then used to perform work on

those dipole charges and scatter them, thereby destroying the source dipole and abruptly shutting off all energy extraction from the vacuum. The other half of the collected Poynting energy is dissipated in the external loads and losses. That means that half the collected Poynting energy is used to kill the source dipole, and less than half is used to power the loads {112}.

Well, we must input at least as much energy (assuming a 100% efficient generator with no losses) to the shaft of the generator to *restore* the dipole, as was used to *destroy* it. This means we shall always have to input *more* energy to the generator shaft, than we get dissipated in the loads.

That is precisely what is responsible for our ubiquitous  $COP < 1.0$  systems. *COP* is Coefficient of Performance, and is the average load power output in the external circuit divided by the average shaft power we pay to input to the generator.

$COP < 1.0$  comes from (i) the ubiquitous usage of the closed-current-loop circuit, and (ii) the prevailing notion that electrical power systems far from equilibrium in their energetic exchange with the active vacuum are impossible to build. In fact, every electrical power system is *already* just such a  $COP > 1.0$  system, as far as the energy flow out of the generator or battery — compared to the shaft input energy to the generator or battery — is concerned.

As is well-known in the thermodynamics of open systems far from equilibrium with their active environment (in this case, the active vacuum), such a system is permitted to: (1) self-organize, (2) self-oscillate or self-rotate, (3) output more energy than the operator himself must input to the system (the excess energy being freely received from the active environment, in this case the active vacuum), (4) power itself and its loads simultaneously (all the energy being freely received from the active environment, in this case the active vacuum), and (5) exhibit negentropy.

But by designing all our systems so that they use more of their collected energy from the vacuum to kill their source dipoles than they use to power their loads, we have foolishly wasted the planet's resources, vastly overcharged the consumer, artificially created a great energy crisis, fomented wars for precious oil and other energy resources, polluted the planet, enhanced global warming, and strangled species.

In short, we pay the power company to have a giant wrestling match inside its generators and lose! And we pay our electrical engineers to keep designing and building such asinine systems!

This sad state of affairs is what is now upon us as a great and increasing energy crisis, polluting and destroying the biosphere, etc. and threatening to eventually collapse the world economy.

It is astounding that, since the basis for the above has been in physics for nearly a century (Whittaker decomposition) and for nearly a half century (broken 3-symmetry of the source dipole, as well as the active vacuum), the hoary old classical EM model has not been updated to incorporate what has already been proven in particle physics. Such is inexplicable and unconscionable.

It is also astounding that no electrical engineer realizes that energy extracted from the vacuum powers every electrical power system, and few if any professors are aware of it either.

This is where your cogent realization of the terrible non sequitur in that atrocious "wave in 3-space" standard diagram leads.

Our AIAS (Alpha Foundation's Institute for Advanced Study) advanced theorists now have a series of papers published in the hard literature pointing out the feasibility of extracting EM energy from the vacuum {113a, 113b}. About 20 other AIAS papers along such lines or related have been submitted to the various journals and are in the referee process.

I just wanted to contact you informally and, for your personal information, show you how perceptive and correct your objection to that atrocious diagram is. You have lifted the corner of the veil on electrodynamics' confusion between effect and cause, with effect being widely used as the cause. The entire notion of a "separate force" acting on a "separate mass" in mechanics is also a non sequitur. If we define force as  $F \sum \epsilon/\epsilon t(mv)$ , then we see that mass is a *component* of force! So here is another major and uncorrected non sequitur. This one was also largely responsible for the dichotomy of the field concept, where the "same field" is used in both a force (mass-containing) manner and a force-free (without mass) manner, as if the two were the same!

I very much enjoyed your editorial, and would urge you to publish additional material along that same vein. You are striking at the very heart of the problem, and every bit of insight and change in those terrible non sequiturs will result in enormous progress in electrodynamics and physics.

Sincerely,

Tom Bearden, Ph.D.

Lt. Col., U.S. Army (Retired)

Director, Association of Distinguished American Scientists

Fellow Emeritus, Alpha Foundation's Institute for Advanced Study

-----



# Chapter 2

## Background and Concepts

*"[Hypotheses made without realizing that they are being made] ...are what Poincare has called "unconscious" or "natural" hypotheses — a type which one hardly ever challenges, for it seems too unlikely that we could make progress without them. Nevertheless it should be the endeavor of the physicist always to drag them out into the light of day, so that it may be perfectly clear what we are actually doing." [Lindsay and Margenau] {114}*

*"Equilibrium states are the only ones that are capable of explicit analysis in thermodynamics..." [Lindsay and Margenau] {115}*

*"Non-equilibrium conditions cannot be specified by variables of state, and their entropy cannot be computed. ...the condition of equilibrium is the condition of maximum entropy." [Lindsay and Margenau] {116}*

### 2.1 Comments on the Foundations of Classical Electrodynamics

#### 2.1.1 Faraday, Maxwell, Quaternions, and Heaviside

For our purposes, we start with the important experiments of Faraday {117}, which produced experimental integration of electricity and magnetism {118}. Faraday's own work contained very little mathematics, and so he himself did not capture his own seminal experimental work in adequate theoretical fashion. That task was undertaken by James Clerk Maxwell {119a, 119b}, who deliberately set about to capture Faraday's results in a proper mathematical theory, using quaternion-like and vector expressions. Of the quaternion algebra, Maxwell had this to say {120}:

*"...the virtue of the 4nions lies not so much as yet in solving hard questions as in enabling us to see the meaning of the question and its solutions."*

Quaternion algebra {121a, 121b} is an advanced algebra created by William Rowan Hamilton, brilliant Irish mathematician. Hamilton was widely regarded as a "new Newton" by his peers. Hamilton coined the word "vector", wrote two books on quaternions, and hoped the books would find extensive use in physics. Vectors and tensors later came to suffice for most problems of that day, and so quaternions faded to the background.

Hamilton also grasped the importance of a science of time, and realized that such a science was possible. E.g., in 1837 Hamilton stated:

*"The notion of time may be unfolded into an independent pure science... a science of pure time is possible."*

In that statement, Hamilton anticipated that a physics model can be comprised using only a single fundamental unit, and that unit could be the second.

In the early 1890s, quaternions in electrodynamics were discarded in a short "debate", mostly in the journal *Nature*, and vector electromagnetics was adopted. So Maxwell's 20 quaternion equations {20} in some 20 unknowns contain a wealth of electrodynamics {122} that is not included in Heaviside's {123} later vector curtailment after Maxwell's death, or in the modern tensor formulation. As an example, Nikola Tesla's patented circuits cannot be properly understood in either a vector EM or tensor EM analysis. However, very novel functions performed in them can be seen in a quaternion EM analysis, as has been clearly shown by Barrett {124}. Any electrodynamicist, who has looked at Tesla's work only in terms of tensor or vector classical electrodynamics, has no concept of what Tesla was actually doing. Since that is precisely how most academics have examined Tesla's work, they have had little idea of the functions he was actually able to accomplish in circuits — functions that U.S. electrical engineering departments still cannot perform.

Along with other electrodynamicists at the time, Faraday and Maxwell believed in a material ether — a thin material fluid filling all space. Hence there was thought to be no point in the universe that was devoid of mass. For that reason, the EM field conceived in mass and the EM field conceived in "space" — actually, in the "luminiferous ether" thought to fill all space — were identically force fields and material entities, at least in the minds of the electrodynamicists at the time. The equations of Maxwell, the later truncation by Heaviside and others, and the final truncation by Lorentz are all still material fluid flow models. They still assume the material luminiferous ether, more than a century after its falsification.



See again Figure 1-3 in Chapter 1. Contrary to the conventional view, force is not a fundamental causative entity, but is a system of two coupled entities. It involves a nonobservable, dynamic, causative 4-space entity (which may be modeled as a curvature of spacetime) interacting with a previous "frozen" observable (a 3-space mass). The output of this interaction is another observable (i.e., a change to the previous observable or an iterative output of its replica). Observables do not continuously exist, but continually recur as continual outputs of the iterative observation process (photon interaction).

Mass is a *component* of force, as is apparent if we define force  $F$  as  $F = d/dt(mv)$ , which gives  $F = m(dv/dt) + v(dm/dt)$ . Both terms on the right of the expansion contain mass; hence force  $F$  contains mass as a *component*. Both terms on the right also contain nonmass terms; hence force  $F$  also contains nonmass coupled to and interacting with mass. So there can be a force generated by a nonmassive non-force entity in spacetime interacting with a mass, and the force only exists when that interaction is ongoing. The ether was erroneously considered to be a material system, containing mass, and hence capable of supporting a force. Maxwell modeled his fields (in what we know today to be mass-free space) as material force fields in the material ether.

In the 1880s, the Michelson-Morley experiments {125a-125d} destroyed the material ether. However, the fundamental Maxwell-Heaviside equations *assuming* those material force fields in the vacuum — which depended on the notion of a material ether and are a function of it — have never been altered, even to this day. Instead, electrodynamicists just assume the force "somehow" goes to zero in the field in space, but the same field remains. The equations still assume the same old material ether.

This is a non sequitur; a *force* field cannot be the same as a force-free *non-force* field. As an example, the EM force field in observable matter is an output of observation. It is therefore a *3-space effect containing mass*. The force-free field in mass-free spacetime (4-space) is a causal 4-space component of massless spacetime. *A priori*, it exists prior to interacting with the charged mass. It contains no observable mass and hence no force since mass is a necessary component of force. It independently exists without the presence of the charged mass at all.

In short, the field in massless spacetime is a specialized curvature (changed region) of that spacetime. *Spacetime consists of spacetime*, to slate a tautology. Once one fixes the concept of the medium, then any changes to the medium can only consist of "medium-stuff. So any

"changes" in spacetime can only be changes of 4-space itself, in the Einstein general relativity sense. This area is handled quite well by Sachs' unified field theory {126a, 126b}, extending and completing the work of Einstein.

Sachs' epochal theory provides a great generalization of general relativity and electrodynamics reaching from the quarks and gluons to the entire universe. Further, Evans' extension of electrodynamics into a higher  $O(3)$  group symmetry turns out to be demonstrably a special subset of Sachs' electrodynamics.<sup>40</sup> Hence, for the first time, an *electromagnetically* engineerable unified field theory is available. Much of general relativity, quantum mechanics, etc. can be engineered directly by Evans' electrodynamics subset of Sachs' overall unified field theory. I am much indebted to Evans {127} for the following statement with respect to  $O(3)$  electrodynamics:

*"In 1992 it was shown (Physica B, 192, 227, 237 (1992)) that there exists a longitudinal component of free space electromagnetism, a component which is phaseless and propagates with the transverse components. Later this was developed into a Yang-Mills theory of electromagnetism with  $O(3)$  Lagrangian symmetry. This theory is homomorphic with Barrett's  $SU(2)$  electrodynamics and has far reaching implications in field theory in general. Recently it has been recognized to be a sub theory of the Sachs theory of electromagnetism, based on the irreducible representations of the Einstein group of general relativity.<sup>41</sup> The Sachs theory produces a non-Abelian structure for the electromagnetic field tensor. The  $O(3)$  electromagnetism also has implications for the **potential** ability of extracting energy from the vacuum, **and its** topological implications are currently being **investigated** by Ranada. The  $O(3)$  electromagnetism has **been tested** extensively against empirical data, and succeeds **in** describing interferometric effects and*

<sup>40</sup> E.g., see M. W. Evans, "The Link Between the Sachs and  $O(3)$  Theories of Electrodynamics," in M. W. Evans (Ed.), *Modern Nonlinear Optics*, Second Edition, Wiley, 2001, part 2, p. 469-494.

<sup>41</sup> Evans et al, "Derivation of  $O(3)$  Electrodynamics from the Irreducible Representations of the Einstein Group," *Found. Phys. Lett.*, 15(2), Apr. 2002, p. 179-

*physical optical effects where the conventional Maxwell-Heaviside theory fails. Implicit in both the  $O(3)$  and Sachs theories of electromagnetism is the ability to extract electromagnetic energy from curved space-time. Working devices based on this ability would help solve the current energy crisis."*

### 2.1.2 Mass Is a Component of Force

The dichotomy of using the field concept in two mutually contradictory fashions as something massless and also as something massive — still unresolved in electrodynamics — is clearly summarized by Jackson's important statement {128} of the prevailing view:

*"Most classical electrodynamicists continue to adhere to the notion that the EM force field exists as such in the vacuum, but do admit that physically measurable quantities such as force somehow involve the product of charge and field."*

In trying to rationalize the "massive field versus massless field" dichotomy, Jackson {129} also states:

*"...the thing that eventually gets measured is a force..."  
"At the moment, the electric field can be defined as the force per unit charge acting at a given point."*

Actually, field is not force, so cannot be force per unit charge. Field produces force when it interacts upon charge. Causing something as an effect, but then being that same effect identically, is a confusion of cause and effect and a non sequitur.

We point out that spacetime is charged, but with *observably massless* (virtual) charge. So the field in spacetime is observably massless and therefore observably force-free. That massless field then interacts with an observable massive charge in the "observable" world, to create an observable force and an observable forcefield. In space, from a quantum mechanical view we may consider the field to have *virtual* force  $\times$  time, since the field may be regarded as a curvature of spacetime acting upon the *virtual* charged masses in the ever-bubbling *virtual particle fluctuations* of the vacuum permitted by the Heisenberg uncertainty principle. Nonetheless, that is only the "potentiality" for an observable force, as pointed out by Feynman and Wheeler, should the field — including its interactions with the virtual charges of the vacuum to produce forces and

accelerations on those virtual particles — interact upon an observable charged mass.

Obviously, the force-free field as a product of spacetime curvature and massless (virtual) charge, and the force field as a product of *that* observably force-free field but virtual force field (in the vacuum) with observable charged mass, cannot be the same thing. Assuming they are the same assumes an oxymoron, and confuses cause and effect. This illustrates the continuing dreadful foundations difficulties propagated in classical electrodynamics.

To resolve these EM foundations difficulties so long maintained and cherished as dogma, the scientific community at the highest priority should (1) fund extensive and rapid work by our very best theoreticians and foundations physicists to heal these century-old festering sores, (2) extend electrodynamics back to a higher group symmetry theory, as in  $O(3)$  EM theory for example, and (3) provide a rigorous dictionary of science foundations concepts and terms which does contain valid definitions and full discussions — clearing misdefinitions and disinformation now notable in the electrodynamics literature.

Nobelist Feynman, co-founder of quantum electrodynamics, was careful to state the notion of the field in mass-free space very differently. Quoting Feynman {130}:

*"...the existence of the positive charge, in some sense, distorts, or creates a "condition" in space, so that when we put the negative charge in, it feels a force. This potentiality for producing a force is called an electric field."*

Feynman's imagery clearly invokes a "distortion condition in spacetime" {131}, eventually coupled to a charged mass and interacting with it — and *then* one has a force and a force field. He erred in still somewhat making the force separate from the charged mass, in the phrase "it feels a force" — which ignores the fact that the mass of the interacting charge is a *component* of the force, not separate from it and not "feeling it as a separate external thing". He pointed out that the field in spacetime represents only the *potential* for a force field, *if a charge should be placed there*. And he points out that the field is a "condition in space" — in the full sense, a condition in spacetime.

We comment that, in a sense, spacetime and vacuum may be considered one and the same. Vacuum contains many fluctuations and virtual state

dynamics, all of which are curvatures of spacetime or produce curvatures of spacetime. Vacuum has energy density, and is therefore a potential. This energy density has dynamics, so the ambient vacuum potential has dynamics, and so therefore does spacetime {132}.

However, a dynamic of the potential is precisely what a field *is*. It follows that dynamics of spacetime are what fields are. So fields (as force-free entities in spacetime) may be taken more accurately as the dynamics of the vacuum-spacetime, or as dynamics of the ambient vacuum-spacetime potential, or as dynamics of the ambient curvature of spacetime.

Again quoting Feynman {133}:

*"We may think of  $E(x, y, z, t)$  and  $B(x, y, z, t)$  as giving the forces that would be experienced at the time  $t$  by a charge located at  $(x, y, z)$ , with the condition that placing the charge there did not disturb the positions or motion of all the other charges responsible for the fields. "*

Here Feynman very clearly shows that E and B involve functions of spacetime  $(x, y, z, t)$  only, prior to interaction, but do not physically exist until interaction with charge has occurred. But he has not quite yet completely eliminated the "force field" as a separate force acting on the charged matter independently. This centuries-old fundamental mistake in mechanics — that force is independent of and external to mass — has simply been propagated into electrodynamics, without correction. Physicists such as Feynman and Wheeler have been trying very hard to correct it.

The observed/measured force field is an output of observation, and observation is a  $d/dt$  operator imposed upon spacetime LLLT. All observables are 3-spatial, and any observation is an instantly frozen "3-space snapshot" at a single point in time. A single observation has no temporal existence *a priori*, since it is only an instantaneous 3-space snapshot existing at one moment only. Hence an observable — being 3-spatial and frozen — does not persist *as such* in time. Indeed, the next instant after an observation, that particular snapshot does not exist any more. [Refer again to Figure 1-3 in Chapter 1].

### 2.1.3 Mechanism for the Flow of Time and Related Matters

It is well recognized that the nature of time is itself an unresolved

question. For our purposes, we are interested in the energetics<sup>42</sup> approach. So we apply that approach to arrive at a mechanism generating the "flow of an object through time". First we will choose our fundamental units.

### 2.1.3.1 *Getting Creative with Fundamental Units*

In physics, the choice of fundamental units one chooses for one's model is arbitrary. Usually mass, length, time, and charge are used, but a perfectly valid model can be generated using only a single fundamental unit.

This is well known to modern physicists and leading electrodynamicists, but sometimes comes as a shock to electrical engineers! Jackson {134} expresses it very succinctly: Quoting:

*"For example, theoretical physicists active in relativistic quantum field theory and the theory of elementary particles find it convenient to **choose** the universal constants such as Planck's quantum of action and the velocity of light in vacuum to be dimensionless and of unit **magnitude**. The resulting system of units (called 'natural units') has only **one** basic unit, customarily chosen to be length. All quantities, whether length or time or force or energy, etc., are expressed in terms of this one unit and have dimensions which are powers of its dimension. There is nothing contrived or less fundamental about such a system than one involving the meter, the kilogram, and the second as basic units. It is merely a matter of convenience."*

So let us consider what happens if we use the joule as the single fundamental unit for a model of physics. Then each of the entities "mass", "length", "time," and "charge" will become totally a function of energy. Since the dawn of relativity and the nuclear age, the notion that "mass is energy" is no problem, and everyone is familiar with Einstein's  $E = mc^2$ . Solving for  $m$  in that expression, one realizes that spatial energy  $E$  has been compressed by the factor  $c^2$ , to yield what is called "mass  $m$ ". More rigorously, compressing the 3-space energy by the factor  $c$ , and then leaving it in 3-space, produces what we call "mass". However, if we

<sup>42</sup> **Energetics** is an **old term from the early birthing** days of electrodynamics. Russian scientists resurrected **the term to cover their use of an expanded electrodynamics** in a unified field-engineering **manner, particularly in new superweapons** developed and tested after WW II and deployed in 1963 and subsequently.

remove it from 3-space and place it over on the fourth Minkowski axis  $ict$ , it becomes what we call "time" because  $t$  is the only variable in  $ict$ . Hence time has or can have similar energy density to mass. Specifically, 1 sec  $\Rightarrow$   $9 \times 10^{16}$  joules of spatial EM energy, when transduced (decompressed) into spatial energy by a transducing charge.

In our new model using only the joule for our fundamental unit, we can also legitimately state that "time is energy", and be rigorously accurate. In that case, we must see what happens to 3-space EM energy when it is shifted to the time domain.

First, we take "EM energy in 3-space" as EM wave energy, in the usual transverse EM wave model (see Figure 1-4 of Chapter 1) of a field entity. We choose, say, the vector  $E$  oscillating in the x-direction, and another field entity (say, the vector  $B$ ) oscillating in the y-direction. If we then rotate each of these vectors into the time axis, then that is an orthogonal rotation for each, which is what the velocity  $c$  actually is. So we have to do two orthogonal rotations, and the two resulting  $c$ 's multiply to give  $c^2$ . With these two orthogonal rotations into the time axis, we have completely rotated the EM field wave energy vectors into the time axis. We have also compressed that EM field energy by  $c^2$ .

Hence "time as energy" is just EM spatial energy compressed by the factor  $c^2$ , but rotated into the time-axis as "time" rather than remaining in 3-space as "mass". Again, by this second analogy time has the same energy density as mass, but the highly compressed spatial energy has been rotated into the time domain to "produce time" rather than remaining in 3-space to "produce mass" {135}.

This sheds new light upon the scalar (time-polarized) photon of quantum field theory. Note that, prior to compression of the wave energy into time, the magnitude of the electric field  $E$  in the EM wave was oscillating lengthwise along its x-direction, which means that, with respect to x, it was a longitudinal EM wave. A similar consideration exists for the oscillation of the magnitude of  $B$  in the y-axis. Along the time-axis, we also have a "time-energy" vector having magnitude, and the magnitude of that time-energy can only vary along the time axis. Oscillating the time energy produces a longitudinal EM wave in the time dimension (on the fourth axis). What is actually varying is the time-density itself. This is a *time-polarized* or *scalar* EM wave, where by use of the term "scalar" we mean that it has no vector component in 3-space. In fact, this variability of time density produces a "galloping motion" in the speed of light itself, which has been recognized {136}.

We have uncovered a direct connection between the time-polarized EM wave (which can only oscillate its time-energy magnitude longitudinally in the time-domain) and the longitudinal EM wave in space. Such waves can only be observed when coupled or paired with an interaction existing between them, very similar to what Mandl and Shaw {167, 168} argue for the time-polarized and longitudinal photons of quantum field theory.

Again see Figure 1-3 in Chapter 1. Any observable is an instantaneous, frozen 3-spatial snapshot (or 3-intersection) of a 4-dimensional ongoing event. "Observation" itself may be taken as a process where a  $d/dt$  operator is invoked upon 4-space (spacetime), leaving a purely 3-spatial output. However, the resulting observable does not "exist or persist in time", since rigorously it is what was "caught" in only a single, frozen "3-slice" at one single instant, forever fixed.

For that reason, time is not an observable. It cannot be directly observed, even in principle, since *a priori* it is discarded by the observation process itself!

For further work along such lines, we recommend the Sachs unification approach to a combined general relativity, quantum mechanics, and electrodynamics, generalized from a topological standpoint {126a, 126b}. To work electromagnetically in that theoretical approach, we recommend the 0(3) electrodynamics as extended by Evans {137a, 137b}.

### 2.1.3.2. *The Four Polarizations of Photons and EM Waves*

In quantum field theory, four polarizations of a photon are recognized {138}. These are the  $x$ -,  $y$ -,  $z$ -, and  $/$ -polarizations, where  $x$ -,  $y$ -,  $z$ - and  $t$ - are assumed as the four dimensions in a 4-space. By agreement,  $z$ - is used as the direction of motion of a free photon or an electromagnetic wave. So at least in theory, there must also be four polarizations of electromagnetic waves, even though not all these waves are yet experimentally known.

The  $x$ - and  $y$ - polarizations are the familiar transverse photon and the transverse wave. The  $z$ - polarization along the line of propagation gives the longitudinal photon in 3-space and the longitudinal EM wave in 3-space.<sup>43</sup>

<sup>43</sup>Here we are **applying the conventional** model of the "EM wave in space", which is known to be erroneous **but is in ubiquitous** usage. See Romer, {84} for a scathing characterization of **that erroneous model**. **But there we are stuck with it, so will use it** as "just a model".



### 2.1.3.3 *Imperfect Longitudinal EM Waves in 3-Space*

When attempting to produce longitudinal EM waves (LWs) in 3-space, from transverse EM waves (TWs) input to some sort of polarization transduction process, only imperfect LWs are produced and a residue of TW content remains. The resulting imperfect LW is referred to as an *undistorted progressive wave* (UPW). Some work has been done on UPWs {139}. UPWs are expected to have remarkable characteristics including wave velocities either slower or faster than  $c$  {140}.

The  $t$ -polarization in the time dimension is quite unique: The *spatial* energy overall is in equilibrium and not vibrating at all; instead, the energy of the photon or wave is vibrating in the time domain and therefore exists in the time domain. That is called a "scalar photon" (time-polarized photon). Its wave version does not yet seem to be known in the literature, although in 2000 we uncovered its secret hiding place {12}. It was unexpectedly hiding in Whittaker's {85} decomposition of the scalar potential in 1903, but had been slightly misinterpreted.

### 2.1.3.4 *Photons and EM Waves Carry Energy and Time*

On the other hand, the concept of "EM waves flowing in 3-space" may be in need of a thorough overhaul {141}. A photon  $y$  is a "piece of angular momentum" in the form of  $y = (dE)(dt)$ . Hence the photon carries an increment of spatial energy  $dE$  and also an increment of time-energy  $dt$ . The time-energy component ( $dt$ ) may be regarded as ordinary spatial energy that has been compressed by the factor  $c^2$  {142}.

As can be seen, since  $c$  represents an orthogonal rotation in  $n$ -space, the multiplication or division by  $c$  and by powers of  $c$  changes the dimensionality of an entity, as seen by the observer in the laboratory frame.

So the photon transports two types of energy: (i) a "weak spring" (spatial, decompressed) energy  $dE$ , so to speak, and (ii) a "very stout spring" (time) energy  $dt$ , so to speak.

When a mass  $m$  absorbs a photon  $(dE)(dt)$ , the  $(dE)$  component is compressed spatially by  $c^2$ , turning it into an extra amount of mass  $dm$ , so that the mass becomes  $(m + dm)*dt$  the same time, the  $(dt)$  component is joined, so that what results is  $(m + dm)*dt$ . In short, mass  $m$  is changed to masstime  $mt$  by photon absorption. So in the absorption of a photon  $y$  by a mass  $m$ , we have

$$y+m \rightarrow (dE)(dt) + m \rightarrow (m + dm)dt$$

In short, the mass  $m$  turns into masstime  $mt$ , by absorbing a photon, and masstime  $mt$  is as different from mass  $m$  as impulse  $Ft$  is different from force  $F$ . We point out that "mass"  $m$  alone does not even exist in time, but masstime  $mt$  does exist in time. This is proposed as a simple but fundamental correction to much of present physics. Further, the state "mt" is an excited, time-charged state, excited by very dense time-energy.

For the simplest case, in the next instant the excited state  $mt$  decays and a photon is re-emitted, and so we have

$$(m + \Delta m)\Delta t \rightarrow (\Delta E)(\Delta t) + m \rightarrow \gamma + m \quad [12]$$

So emission of a photon changes the excited masstime state (time-charged state) back to mass (uncharged state with respect to time-charging), in the simplest case.

See again Figure 1-3 in Chapter 1. "Observation" and "observable change" are in fact generated by the photon interaction. The total photon interaction with a mass creates the "flow of that mass" through spacetime, macroscopically as seen by the observer and microscopically in myriad streams of virtual time changes. Mass is continually charged to the masstime state, and the masstime state is continually decayed to the mass state. Time flow itself thus has a myriad internal EM energy streams and a vast dynamic EM energy substructure.

The photon itself is not observable, as it exists prior to interaction. It is thus a "causal" entity in 4-space. It *is not* a simple 3-space observed "frozen snapshot" particle! When the causal photon is absorbed, its spatial energy component goes through the  $c$  compression function, thus adding a small amount of new mass to the previous mass (previous effect), but simultaneously connecting its  $dt$  time-tail, so that the slightly increased mass in fact now exists as masstime and not mass. Observation has not been completed at that point.

In the next instant, a photon is re-emitted (from masstime, never from mass!), in the simplest case removing that extra little mass increase and orthogonally rotating it back into 3-spatial EM energy, coupling that spatial energy increment  $dE$  to that "time-tail"  $dt$  and tearing it away as the photon is re-emitted. That leaves behind a frozen 3-space snapshot of the mass (the interacting particle) and completes the "observation". In the simple case, this is a replica of the previous particle (frozen 3-space snapshot) with which the causal photon interacted. So this process accounts for the so-called "persistence in time" of an object or mass, as seen by the observer's continual recall process accompanying his stream of

iterative observations. Mass does not *continuously exist* in time, but *continually recurs* in time.

As is well known, what we call "observable" change must involve the expression in equation [13] in the fashion discussed and with the observation mechanism given.

We first pointed out the preceding mechanism for the "flow of a mass through time" in 1971, as a graduate student at Georgia Institute of Technology, and later published it in a crude paper {143} in 1973. It still needs a far more thorough theoretical treatment, which perhaps some graduate student will take up as the subject of his or her doctoral thesis.

**2.1.3.5 Photon Interaction: Mechanism Generating Flow Through Time**

See Figure 2-1. Mass does not really "travel through time" continuously *per se*, but proceeds with an overall serial change mechanism as

$$m \rightarrow (mt) \rightarrow m \rightarrow (mt) \rightarrow m \rightarrow \dots \quad [14a]$$

where  $(mt)$  symbolizes a nonobservable ongoing "coupled" interaction state prior to observation completion. Equation [14a] represents the results of the continual photon interaction process, observation process, and "flow of a mass through time" process, at the highest single-photon interaction or quantum change level, and as "seen" or measured by the external observer.

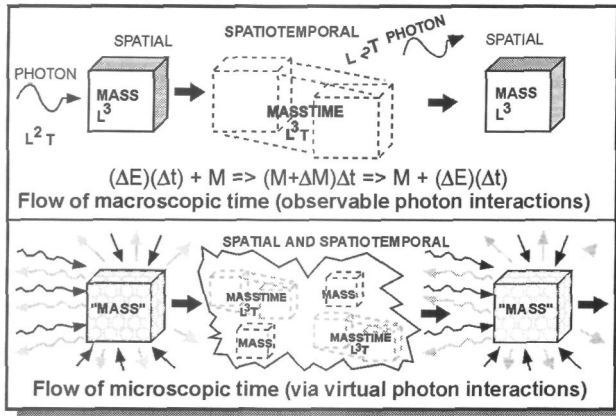

Figure 2-1 Mechanism for the flow of a mass through time.

Also, in that overall quantum level "flow" there are any number of ongoing streams and "sublevels" in the underlying subquantum level (in the virtual vacuum and in its virtual photon interaction with observable

mass). We might write one of these "internal time-stream interaction flow substructures" as:

$$(\delta m) \rightarrow (\delta mt) \rightarrow (\delta m) \rightarrow (\delta mt) \rightarrow (\delta m) \rightarrow \quad [14b]$$

In equation [14b] we have used parentheses, because all terms individually are nonobservable. We hypothesize that each stream continues until one of its terms participates in a summation which eliminates it by enfolding it into another interaction.

When a mass is observed as in [14a], a photon has been emitted (we observe the mass as the "effect" remaining). Time has been stripped away by the resulting  $d/dt$  operation, leaving a frozen 3-spatial snapshot, which we will see as (having been) a particle (simplest case). That occurs just after major ("observable") photon emission from the masstime state {144}. Immediately another observable photon is absorbed, and so state  $mt$  occurs. The particle of mass actually oscillates at a very high rate between the  $m$  and  $mt$  states — so high a rate that by arranging the interaction conditions one may interact with it either as a wave (react predominantly in the  $mt$  state) or as a corpuscle (react predominately in the  $m$  state).

Hence we propose that the process in [14a] may account for the duality of particle and wave.

#### 2.1.3.6 *The Overall Flow of Time Has an Internal Dynamic Structure*

During the transition in any mass to masstime state by reaction of the mass with an "observable" photon, a myriad of fleeting virtual photon interactions involving very tiny ( $dE$ ) ( $dt$ ) components occurs with the mass  $m$ . These tinier increments of time, and their increments of energy, constitute internal structures in the time flow process. Therefore they may be considered as "energy currents" or "time-like energy currents" and dynamic structures or streams inside the flow of time. This is particularly straightforward if we use a model having only a single fundamental unit, the joule. In that case, time is energy, and we are speaking of energy flow and its constituent internal structures of energy flow.

So the  $dt$  component of masstime at the observable-photon action level has a myriad of energy-time structured dynamics infolded within it. Hence the  $mt$  state is very dynamic in time, particularly for fundamental particles. The  $mt$  state is in fact a "collection of time-energy dynamics" and therefore "wavelike".

See again Figure 2-1. A major point is that *mass* does not emit a photon; *masstime* does. Mass "travels through time" by an extremely high oscillation between corpuscle-like state  $m$  and wavelike state  $mt$ , and with

a vast internal "dynamic streams" of other such high oscillations between corpuscle-like  $m$  states and wavelike  $mt$  states.

The concept can be very much extended, of course, but this suffices for our concept of energy currents in time, the interaction of such energy currents with mass in a mass system, and the internal dynamic structuring of the "flow of time".

This internal structuring is important in the event of "*time-energy*" *charging*. There the internal structure of time has experimental consequences. We will discuss those consequences in later chapters.

#### 2.1.4 The Ubiquitous Substitution of Effect for Cause

See Figure 1-3. To repeat, no observable exists or persists *as such* in time. An observable *as such* only exists at all when time has been momentarily stopped. It then quickly changes into (observable  $\times$  time) form, for a time interval after a photon absorption. Then it changes again to observable form by photon emission and the corresponding  $d/dt$  differentiation imposed by that photon emission.

What happens when we think we see an "observable moving through space" is that we make or suppose a continual series of very fast  $d/dt$  3-spatial snapshot observations, one after the other in serial fashion (much like the individual frames of a motion picture film). For more than a million years, human brain and mind processing have "always interpreted" this serial set of iterative operations occurring in the eyes and in the physical senses — and continually recalled and processed by the mind — as an "observable persisting in time", which it is not.

This age-old "natural" and inbred, instinctual *mentalpractice* and assumption by humans — and therefore by scientists — has provided a major problem in physics and especially in electrodynamics. It has resulted in the substitution of the "effect" for the cause in a great number of models. Even a rapid and continual series of 3-space effects after reaction of an observable (frozen snapshot) with a 4-space causal entity, does not and cannot constitute that 4-space entity which interacts with the previous "frozen snapshot" observable and causes the resulting "comparative change or sameness" of the new observable with the former. Hence, e.g., Romer's scathing condemnation {84} of the conventional drawing of an "EM wave in space".

In general relativity, it is straightforward. The curvature of spacetime — the cause — is not the mass (the 3-space observable effect) that is further changed or created again in the ongoing interaction, as seen in the "next

3-space snapshot" (next output of observation) when comparing that snapshot to the previous one.<sup>44</sup>

The same non sequitur — unwitting substitution of effect for cause — has existed for hundreds of years in mechanics, for example. There it is strongly passed on in the erroneous old notion of a separate force acting upon a separate mass. *Prior to* the interaction, no "force" exists. *During* the ongoing interaction, force exists because it is the product (interaction) of a "non-force" causal entity (e.g., a field in 4-space, as a certain curvature of spacetime there) and a previous effect (a 3-spatial frozen snapshot called "mass"). The force exists during the interaction and only during the interaction, when both cause and previous effect are coupled (and will produce the new effect at the completion of the next serial  $d/dt$  operation as a photon is emitted). The force can only exist when the mass (previous effect) is coupled to the cause (the curvature of spacetime), since *a priori* mass is a *component* of force {145}, and curved spacetime is another *component* of it. After the interaction "ends" in a new  $d/dt$  observation, the mind compares the new effect with the former, to determine whether there is a "change" or a replica (sameness). This comparison of the new observation (observable) with respect to the former, *occurs in the brain and mindprocessing*, and gives the sense of "persistence of an object in time" as well as of an object "changing in time".

So a great faux pas in physics — and especially in electrodynamics — is this widespread substitution of the effect for the cause. Understanding this non sequitur clearly, and correcting it, is a prerequisite to understanding the principles and concepts of legitimate COP>1.0 Maxwellian systems. Also, if we would ever hope to adequately correct electrodynamics, this tremendous faux pas must be recognized and rooted out of the model. Indeed, the same is true for mechanics and other branches of physics.

### 2.1.5 Some Additional Foundations Non Sequiturs

Another gross non sequitur is made in calculating the amount of EM energy flow continually being diverged around an intercepting unit static charge at a point in space, from a potential in which that point is located, and then calling this "local intensity" of the collecting interaction the "magnitude of the potential" itself.

<sup>44</sup> Rigorously, if one wishes to connect spacetime and mass, spacetime can be interpreted in *masstime* units, but not *mass* units. And vice versa. Again, *masstime*  $mt$  is as different from mass  $m$  as impulse  $Ft$  is **different** from force  $F$ .

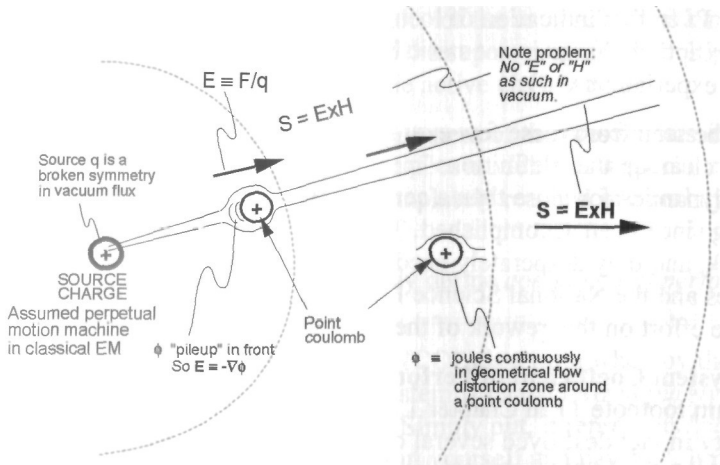

Figure 2-2 Field and potential are defined in terms of the diversions from them around a unit point static charge assumed at any spatial point

(See Figure 2-2). At best, it is a measure of the *local intensity of the diversion of energy flow* from the "bidirectional" EM longitudinal waves comprising a potential, as they are diverged around the unit point static charge. It is not the magnitude of the entire potential, filling all space, nor does it prescribe the spatial energy magnitude of that entire potential {146}. It is a small energy flow, *diverted* by an assumed standard fixed charge at a single point in the potential, from the overall energy flows comprising the potential. Calling this little "diversion of a bit of energy" the magnitude of the potential is rather like calling a little whirlpool in a river the "magnitude of the river". Or more exactly, it is like calling the amount of little "swirl diversion of a river's flow" around a standard small fixed rock the "magnitude of the river".

A similar non sequitur exists in the usual calculation of the "field" magnitude at a point, which is not the "entire field entity itself at all. It is merely what is *diverged from* the "field as it exists in spacetime" at a single point in it, by an assumed fixed standard point charge at that point that is interacting with the field. The field takes into account the patterning of the diverged flow, e.g., the difference in potential (difference in

pressure) across the unit point charge. That is not the field itself at all, and the textbooks and dictionaries of physics are completely wrong in calling it such. Again, at best, it is an indication of *the field intensity* at that point, and the reaction cross section of the field to an assumed unit point static charge. Even that indication of local intensity of the field will change if the intercepting charge is not static but is in resonance, as shown by the Bohren experiment {24}.<sup>45</sup>

As can be seen from these few examples, a great deal of work needs to be done to clean up the "definitions" promulgated in physics and electrodynamics for more than a century. It is inexplicable<sup>46</sup> that this has not long since been accomplished. These errors permeate almost every textbook, and they desperately need correcting. The National Academy of Sciences and the National Science Foundation should fund the best possible effort on this rework of the foundations of physics.

### **2.1.6 System Coefficient of Performance (COP) and System Efficiency**

See again footnote 11 in Chapter 1 and Appendix A. In 1915, general relativity in fact destroyed several of the fundamental definitions (axioms) of classical thermodynamics. It necessitated our correction of some thermodynamical definitions (open system and closed system) and our more rigorous definitions of COP and efficiency advanced below.

Once mass is recognized as energy and the two are just different sides of the same coin, there can be no thermodynamically closed system which passes energy across the system boundary without passing mass across it. Any system changing its rate of flow through time also changes its mass and its energy, and vice versa. Energy has mass characteristics, and any mass system with added or subtracted energy — either kinetic or potential

<sup>45</sup> Many Bohren-type experiments are continually done in nonlinear optical labs in universities and elsewhere. The effect (excess radiation from the medium) is euphemistically called "negative absorption of the medium," "negative resonance absorption of the medium," etc. Such terminology avoids clearly recognizing that more energy is output than the scientists (erroneously) calculate was input. Bohren faced the issue head-on, and clearly stated that more energy was output than was input (or than was thought to be input).

<sup>46</sup> A true pessimist might point out that it may be quite understandable, considering that it solidly blocks COP>1.0 EM electrical power systems and electro-gravitational anti-gravity systems from being developed by our universities, which would solve the energy and transportation crises forever. Thereby it also keeps about \$1.5 to 2 trillion a year pouring into the coffers of controlling financial groups behind many great interlocking corporations.



— will also change its mass relativistically as well as its other characteristics such as inertia and gravitational attraction. As pointed out by Logunov and Loskutov {635}, in 1917 the new characteristics of general relativity led Hilbert {632} to observe that in general relativity there can be no energy conservation rules of the usual classical kind. This also follows from our consideration of the supersystem with multiple active environments rather than a single active environment.

We have formally destroyed any absoluteness of the present classical thermodynamics, which is just an imperfect model. It is a special case which can be approached but never completely reached in a real dynamic system.

With that in mind, we now more exactly define *coefficient of performance* and *efficiency* of a system.

The term "coefficient of performance" (COP) is a ratio whereby the useful energetic output performance of the system is characterized *purely with respect to the operator's energy input*. Simply put, it represents "how much you get for what you have to input yourself and pay for". It does not characterize the performance of the system with respect to the *total energy input from all sources*. For our purpose, in general there are two major ways of expressing this COP:

- (a) COP == (work accomplished in the load during a representative time of operation) divided by (energy input by the operator during that representative time of operation). Or for short, COP = (useful work out in the load) + {operator's energy input). We stress that there may be other free inputs of energy to the system, in addition to the operator's input, but only the operator's input is accounted in the COP calculation.
- (b) COP == (average power out in the load) divided by (average power input by the operator).<sup>47</sup> Again, there may be additional average power inputs that are freely input from the environment, without cost to the operator, but only the *operator's* input is accounted. We stress that "power input" is

<sup>47</sup> This is in standard electrical engineering terminology, which is mangled. For a more precise physics statement of (b), COP == (the average rate at which the system dissipates energy in its load to do useful work) / (the average rate at which the operator must furnish energy to be dissipated as work in the input section of the system to make it operate and do its output work).

another of electrical engineering's misnomers, but we use it here because it is universally used in power system engineering.

For a system such as a transducer, which merely changes the form of the energy in some fashion and does not perform work in an external load (the transducer is its own load), we may express the COP as

- a.  $COP == (\text{effective energy output}) / (\text{energy input by the operator})$ . Here we accent that there may be additional energy inputs to the system from the active environment, and these inputs are "free" and are not input by the operator, so they are not accounted in the COP calculation.
- b.  $COP == (\text{average power output}) / (\text{average power input by the operator})$ . Again, additional average power inputs may be freely received from the environment, but they are not accounted in the COP calculation.

The "efficiency"  $E$  of a system is a ratio less than or equal to 1.0 (or a percentage less than 100%), where  $E$  indicates the percentage of the total input energy (from all sources) that is dissipated in the load as useful work. It follows that  $(1 - E)$  indicates the percentage of the total input energy that is dissipated in the internal losses in the system, not directly resulting in useful work by the system in its load. So the efficiency  $E$  of a system may be expressed as:

- a.  $E == (\text{total work output in the load during a representative operational period}) / (\text{total energy input to the system, from all sources, during that period})$ .
- b.  $E == (\text{average power output in the load}) / (\text{average energy rate of input to the system, from all sources, during that representative operational period})$ .

We accent that no system can have an efficiency greater than 100%, for then it would be "creating energy from nothing" {147}. No system can dissipate or convert energy that it does not first receive. The conservation of energy law states that energy can neither be created nor destroyed. This means that *there actually are no energy sources per se, in the sense that the source creates the energy*, even though we use the terms "energy

source" and "source of energy" informally. E.g., Semiz {148} states it this way:

*"The very expression 'energy source' is actually a misnomer. As is known since the early days of thermodynamics, and formulated as the first law, energy is conserved in any physical process. Since energy cannot be created or destroyed, nothing can be an energy source, or sink. Devices we call energy sources do not create energy, they convert it from a form not suitable for our needs to a form that is suitable, a form we can do work with."*

A medium inefficient system can easily have a  $COP > 1.0$ , if it receives additional energy from its active environment, and if that extra free energy is sufficient to overcome its internal inefficiency losses. An example is a common windmill, where a very good one may have an efficiency of less than 50% due to friction and drag losses in the gears and wind spillage losses in the blades, etc. Yet the operator himself does not have to input any energy at all, for the windmill to operate continually. In this case, the  $COP \gg 1.0$  and approaches infinity, but the efficiency of the windmill is still less than 50%.

Another example is the home heat pump, which may also have an efficiency of less than 50%. When acting as a refrigerator, its theoretical maximum  $COP = 8.22$  under nominal conditions {149}, and a well-designed 50%-efficient home heat pump will produce  $COP = 4.0$  when conditions are suitable.

On the other hand, if the only net energy input to the system is that energy that the operator inputs, then the  $COP < 1.0$ . This is a system in equilibrium with respect to any energy exchange with its external environment — *except* with respect to the energy input by the operator (i.e., with respect to its "fueling" by the operator, so to speak) and with respect to the energy subsequently dissipated in the loads and losses. If the system is 100% efficient (has no internal losses or conversion losses at all), its  $COP = 1.0$ . Almost all real systems do have internal losses, so their efficiency is  $E < 100\%$ . In that case, the system in equilibrium with its environment, and having  $E < 100\%$ , will also exhibit  $COP < 1.0$

irrevocably. Indeed, the same number will give both the efficiency  $E$  and the COP, because numerically they are then the same.<sup>48</sup>

For electromagnetic systems, the state of confusion between efficiency  $E$  of the system and the COP of the system is due to one fact. *Numerically* the two are always equal in *equilibrium* systems — and the Lorentz regauging condition enforced by the closed current loop circuit self-enforces the equilibrium condition of the system with respect to its active environment. Because electrical engineers usually have zero experience with  $\text{COP} > 1.0$  electrical systems, they tend to loosely and erroneously use the two terms "efficiency" and "COP" as if they meant the same thing. They do not.

Now suppose that we have an open system, far from equilibrium in its energy exchange with its active environment. Suppose that the system's efficiency  $E$  is very poor, so that  $E = 20\%$ . Now suppose that the environment inputs twice as much energy as does the operator. Let the operator's energy input be  $E_1$ . Then the total energy input to the system, from both the operator and the environment, is  $3E_1$ . The efficiency is only 20%, so the system outputs  $W$ , as work in the load, of  $W = 0.2(3E_1) = 0.6 E_1$ . The COP of the system is the work out divided by the operator's input, which is  $\text{COP} = W/E_1$ , which is  $\text{COP} = 0.6 E_1 / E_1$  which gives  $\text{COP} = 0.6$ . As can be seen, even though this system receives twice as much additional free energy as what the operator inputs, it is so inefficient that **its COP < 1.0**.

Suppose we have a similar system with the same energy inputs from the operator and from the environment, but now the system's efficiency  $E$  is  $E = 90\%$ . Then the total energy input to the system, from both the operator and the environment, is  $3E_1$ . The efficiency is 90%, so the system outputs  $W$ , as work in the load, of  $W = 0.9(3E_1) = 2.7 E_1$ . The COP of the system is the work out divided by the operator's input, which is  $\text{COP} = W/E_1$ , which is  $\text{COP} = 2.7 E_1 / E_1$ , which gives  $\text{COP} = 2.7$ . As can be seen, a more efficient system in the same energy input situation, now outputs more work than the energy input by the operator. Energy is conserved at all times; the excess energy for the additional work was in fact freely input

<sup>48</sup> We emphasize that COP and efficiency are two quite different concepts, however, even when their numerical values are the same. A 6-foot tall man and a 6-foot tall door have the same number for their **height**, but only a fool would consider them the "same thing".

to the system — which is an "open" system far from equilibrium in its exchange with its active environment.

Thus a system far from equilibrium in its energetic exchange with its active environment, is *permitted* to exhibit  $COP > 1.0$  even though its efficiency is always less than 100%. On the other hand, if the system is very inefficient and the energy input from the environment is not too great, the system will still exhibit  $COP < 1.0$ . But the operator will pay less for his energy costs to operate that inefficient system, than he would pay to operate it if he himself had to furnish all the energy input.

Two cautions are emphasized:

(a) First, electrical engineers use the term "power" to mean "energy flow rate without dissipation or change of form", as well as "energy flow dissipation and change of form rate." This is inexact and unfortunate, but it appears ubiquitously throughout the electrical engineering literature. So we are essentially "stuck with it" for the moment. From a rigorous physics point of view, energy flow without divergence or change has absolutely no power, because power is defined as the rate of change of the form of that energy flow — e.g., the rate of dissipation (scattering) of that energy flow, which in physics is a rate at which work is being performed.

(b) Second, it seems that more than half the engineers and scientists — and many textbook authors — do not clearly understand the difference between COP and efficiency, and often interchange these two terms as if they were the same. They are not at all the same, and a great deal of confusion exists in the casual engineering literature because of using them interchangeably. That is why we have clarified them and given some simple explanatory examples, sufficient for our purpose in this book.

### **2.1.7 COP > 1.0 and the Question of Perpetual Motion**

Legitimate scientific researchers attempting to work in open EM systems far from thermodynamic equilibrium are often subjected to rather vicious ad hominem attacks, charging that they are perpetual motion machine addicts and therefore raving lunatics. This of course is not true. We are simply trying to do with Maxwell's "electric fluid" systems what nature already shows us can be done with material fluid systems. We are in fact seeking the equivalent of "electromagnetic heat pump" processes and systems. It is the strident critics who are thoroughly confused and who reveal an immature knowledge of physics and thermodynamics.

As we explained, prior to their Lorentz symmetrical regauging, the Maxwell-Heaviside equations already clearly prescribe and permit  $COP > 1.0$  EM systems, including EM power systems. In addition to the present EM systems in equilibrium in their exchange with their active vacuum environment, the non-regauged equations also include Maxwellian systems far from equilibrium in their energetic exchange with an active environment, such as the active vacuum. Classical *equilibrium* thermodynamics — stridently waved as a sacred banner by the critics accusing  $COP > 1.0$  researchers of being "perpetual motion nuts" and such EM systems as being "perpetual motion nonsense" — does not even apply to such *disequilibrium* systems! One should simply read the literature of the thermodynamics of such disequilibrium systems {160a-160f}. Or one should read why Prigogine was awarded the Nobel Prize in Chemistry in 1977, for his contributions to such open systems in disequilibrium.

We accent again that, under our new rules where we corrected the thermodynamic definitions of open system and closed system, we are in compliance with general relativity. Further, every EM system must be taken as an open system, since in the supersystem energy (with mass-like changes resulting across the system boundary) is always exchanged between the three supersystem components.

Fortunately there are also rational, reasonable critics such as Angrist {150, 151} where the criticism is properly scientific and not ad hominem, even though still misguided. Usually the rational perpetual motion critic applies the three laws of classical *equilibrium* thermodynamics, to classify "perpetual motion machines" of class 1, 2, and 3 after equilibrium thermodynamics laws 1, 2, and 3. This of itself has no intellectual content for open systems in disequilibrium with their active environment. The classical equilibrium thermodynamics — including laws 1, 2, and 3 interpreted only in terms of the operator's energy input — does not apply to *open systems far from equilibrium* — which are the only systems permitted to exhibit  $COP > 1.0$  in the first place. And we insist that all EM systems are open systems far from thermodynamic equilibrium, since every charge is, and all fields and potentials come from those source charges. Indeed, such open disequilibrium systems are *permitted* to violate the laws of classical thermodynamics! As an example, the entropy of such an open disequilibrium system cannot even be computed {152}, and it is less than the entropy of the same system in equilibrium, since the equilibrium state is the state of maximum entropy.

The rational critic then falls upon the horns of a dilemma, by admitting that, yes, such open dissipative systems do exist and do permissibly exhibit

COP>1.0. He then labels these *as, false or fictitious perpetual motion machines* {150, 151}. In short, when such COP>1.0 machines are real and admittedly exist, they are not "*true*" perpetual motion machines but *fictitious* perpetual motion machines. My comment is that they are not perpetual motion machines at all, but permissible disequilibrium machines freely receiving excess energy from their energetic exchange with their active environment. They are no more mysterious than a windmill, a sailboat, a watermill, or a solar cell bank.

One must be precise. A bicycle is a free-energy COP>1.0 machine while going downhill. It is not such at all when going uphill. The difference is that gravitational input of energy aids the bicycle's motion in the downhill case, and opposes it in the uphill case. The active environment gives the system additional energy in one case, and takes energy from the system in the other case. Disequilibrium exchange can cut either way!

It is precisely the EM system far from equilibrium with its active environment — where the environment puts in additional energy — that the serious overunity researcher is seeking. It is a perfectly valid pursuit, even by the standards of the perpetual motion critics, who really should study *both* kinds of thermodynamics, not just *one*. They also should study how Maxwell's equations were curtailed and truncated; one result is that all Maxwellian disequilibrium systems were — and are — discarded *arbitrarily* by the Lorentz symmetrical regauging.

The only criticism one needs to raise vis a vis COP>1.0 and perpetual motion machines is this: If an inert (no hidden internal source) machine receives no net energy from its external active environment, but is in equilibrium in its energetic exchange with that environment,<sup>49</sup> then

<sup>49</sup> Here we quibble again and point out that Lorentz's symmetrical regauging actually does require that the system receive and take on excess EM potential energy from its environment (the active vacuum and the local curved spacetime). However, this excess energy can only be received in the form of two injections of field energy, where the fields are equal and opposite. Hence the energy is "bottled up" as a stress potential, with net zero translation force available to it. Since this stress potential energy cannot translate electrons, it cannot do work in an external load. It merely changes the stress of the system itself. The net result is actually a rotation of the frame in which the system exists, away from the "laboratory frame" of the observer. In short, the Lorentz condition establishes a new "equilibrium condition" for the system, by rotating its frame. It also implies that EM energy is continuously received by the system from both the active vacuum and local curved spacetime, in order to maintain the rotated frame and **the** new equilibrium condition. Further this

classical thermodynamics rigorously applies to it and the machine cannot and will not exhibit  $COP > 1.0$ . However, all EM systems contain charges, and these are indeed "hidden sources" of EM fields and potentials and their energy. It *rigorously follows that, since they contain hidden energy sources, all EM systems are potentially  $COP > 1.0$  systems a priori.* Further, *it follows that some ubiquitous design characteristic of the system itself must prevent the system from achieving  $COP > 1.0$ , since nature does not prevent it.* That characteristic feature is the ubiquitous closed current loop circuit, directing all spent electrons in the external circuit right back through the source dipole in the generator or other primary power source.

It is indeed mandatory that — if at all possible - the inventor or independent researcher *identify* a legitimate source of environmental energy that his purported  $COP > 1.0$  device receives and collects, and how it receives it and then uses it to power the loads. That means he should identify where and how his system violates the Lorentz self-regauging condition imposed by the standard closed current loop circuit. If the inventor himself cannot explain it — and this does happen — then someone else must explain it for him. If the machine works under proper independent test and replication, then criticism that no explanation exists for it in normal physics is of no relevance. It is a spur to the theorist to enlarge his horizons and to find the proper physics that *does* explain it.

We stress that we cited the works of Angrist because his voice is reasoned and he does not stoop to name-calling and ad hominem attacks. He also does point out a historical rash of machines that clearly must comply with classical equilibrium thermodynamics, because they have no discernible or stated extra input of energy from their active environment and have no self-asymmetrical regauging. When such machines have no external free input of energy from their active environment, they are systems in equilibrium with their active environment, and cannot exhibit  $COP > 1.0$  — exactly as pointed out by Angrist. With such a reasoned critic, a scientific dialog is possible, and his main thrust — that no *equilibrium* system can exhibit  $COP > 1.0$  — is quite valid. With the vehement critic, it is already a cur dog fight from the outset and there can be no scientific discussion at all.

The only contention one has with a rational critic, whose criticism is based on classical thermodynamics, is when he then generalizes that *all EM*

continuous input of two energy flows, equal and opposite, does continuous internal work on the Maxwellian system to increase and maintain its stress.



systems fall within this class. That conclusion is a non sequitur, and ignores the entire science of disequilibrium thermodynamics and a vast body of scientific literature and scientific experiments in electrodynamics. When stated for electrodynamic systems, it also ignores the actual documented history of electrodynamics, and ignores Lorentz's *arbitrary discard, from all accountability*, of the Heaviside giant nondiverged energy flow component accompanying every circuit and system. It also ignores Lorenz's and then Lorentz's symmetrical re-gauging of the Maxwell equations to give new and simple equations easier to solve. This arbitrary re-gauging did in fact unwittingly discard all open disequilibrium Maxwellian systems — precisely those permitted to exhibit  $COP > 1.0$ .

See again Figure 1-1. The energy entering the circuit is entering it from the surrounding space outside the circuit. Heaviside showed that the energy flow component remaining after the Poynting component is withdrawn is orders of magnitude greater than the Poynting component entering the circuit and powering it. *It can easily be demonstrated that every generator outputs far more EM energy in space surrounding the power line attached to it, than the operator inputs as mechanical energy to the shaft.*<sup>50</sup>

<sup>50</sup> E.g., just use a gedanken experiment followed by the Bohren {24} experiment as validated by Paul and Fischer {25}. Consider a 100% efficient DC system, powered by a DC generator, using a closed Current loop circuit. All the Poynting energy received by the system appears at first blush to be dissipated in the external load. That is not true, but let us not yet belabor the point. Include the complete circuit loop back through the source dipole in the generator. The back emf voltage across the source dipole between the terminals is precisely equal to the forward emf voltage between the terminals but around the external half-loop. The same current flows through both the forward voltage drop and the reverse voltage re-potentialization. So precisely as much energy is dissipated to force the current through the back emf, as is recovered from the load.

Accept the conventional view that the shaft energy input to the generator is transduced into magnetic energy, which is then dissipated to force those charges back through the back emf. Now examine the energy flow in space surrounding the external circuit, using both the Poynting theory and Heaviside's theory. We have accounted for the Poynting diverged component, but we have not accounted for the huge remaining nondiverged Heaviside component. From whence comes this excess remaining energy flow that did not enter the circuit, was not included in the Poynting calculation, and was not expended in the circuit but was just wasted? To prove the excess energy flow really exists, perform the Bohren experiment {24} where the intercepting charges in the circuit are in resonance, and thus "sweep out" a larger geometrical cross section of interception of the impinging energy flow. These charges do sweep beyond the static unit charge cross section conventionally assumed in the definitions of field intensity (e.g., of the fields E and H in the Poynting vector  $S$  in  $S = (E \times H)$ ). If the defining unit point charges are in resonance and sweep out a

Heaviside knew this in the 1880s. All the energy flow that is intercepted by the circuit and enters (i.e., the Poynting component) at essentially right angles, hardly even changes the angle of flow of the remaining huge flow of energy surrounding the circuit and missing it. Quoting Heaviside {153} directly:

*"It [the energy transfer flow] takes place, in the vicinity of the wire, very nearly parallel to it, with a slight slope towards the wire.... Prof. Poynting, on the other hand, holds a different view, representing the transfer as nearly perpendicular to a wire, i.e., with a slight departure from the vertical. This difference of a quadrant can, I think, only arise from what seems to be a misconception on his part as to the nature of the electric field in the vicinity of a wire supporting electric current. The lines of electric force are nearly perpendicular to the wire. The departure from perpendicularity is usually so small that I have sometimes spoken of them as being perpendicular to it, as they practically are, before I recognized the great physical importance of the slight departure. It causes the convergence of energy into the wire. "*

So every electrical power system is rigorously a COP>1.0 "energy gating" system already, if the neglected, enormous Heaviside energy flow through space around the circuit (and missing it and wasted) is re-accounted. In that case, much greater energy pours out of the terminals of every generator, than the feeble amount of mechanical energy we input to the shaft.

We do not have an *energy availability* problem, and we never have had one! Instead, we have an *energy flow interception and collection* problem

greater cross section, then the assumed Poynting vector  $S$ , for the static case, changes in magnitude by some ratio  $k$  for the resonant case to the vector  $S_R$ , so now  $S_R = k_1 E \times k_2 H = k_3 (E \times H)$ . Since  $k_3$  is just the ratio of the actual geometrical cross section swept out by the charge to the standard geometrical cross section swept out by the static charge, then for a static charge  $k_3 = 1.0$ , and for a resonant charge  $k_3 > 1.0$ . Hence the Bohren experiment, with  $k_3 = 18$  or so, produces 18 times as much collected (Poynting) energy "out" as we erroneously think we input by normal calculations ignoring the input Heaviside nondiverged component. The Bohren experiment {24} proves the argument; validation by Paul and Fischer {25} appears in the same journal issue.

— and we always have had one, due to the ubiquitous use of the closed current loop circuit.

Texts — e.g., such as by Kraus {154} — do show the Poynting (intercepted and collected) component of the EM energy flow surrounding the power line attached to the generator terminals, but none of them today go into the remaining nondiverged Heaviside component. Each of Kraus' contours {76} of energy flow in space, around those power line conductors, shows *only that part of the energy flow in space that is being drawn into the circuit*. It does not show the remaining huge energy flow that (i) is not intercepted, (ii) does not enter the circuit, and (iii) is wasted. Presently no texts illustrate this Heaviside nondiverged energy flow component, and no text accounts for it except to point out that the Poynting component must be considered to be indefinite, since it can be accompanied by an additional energy flow component. The texts then erroneously conclude that the excess flow can have no physical significance.<sup>51</sup>

One can easily prove the existence of additional energy flow to be collected, in addition to the Poynting component. E.g., simply examine the Bohren experiment {155} and its replication by Paul and Fischer {156} — or one can repeat the experiment oneself. The Bohren experiment outputs some 18 times as much energy as is input by normal "Poynting component" calculations alone, because it also intercepts additional energy from the unaccounted and ignored *free* Heaviside input component remaining and not diverged by a *static* unit point charge. Bohren simply places the charge in resonance, so it sweeps out a greater geometrical reaction cross section in the energy flow, thereby penetrating into the free — but arbitrarily discarded and unaccounted — Heaviside component, and intercepting and collecting additional energy. Bohren is perfectly aware that the excess energy caught by the resonant charges comes from the surrounding vacuum. However, he seems quite unaware of Heaviside's

<sup>51</sup> E.g., J. D. Jackson, *Classical Electrodynamics*, Second Edition, Wiley, 1975, p. 237: "...the Poynting vector is arbitrary to the extent that the curl of any vector field can be added to it. Such an added term can, however, have no physical consequences." Jackson errs in stating that the added energy flow vector cannot have any physical consequences. It cannot, of course, unless one catches some of it and uses it to power a load, without using half of the caught energy to destroy the source dipole faster than the load is powered. One of the major applications of it is to use it with Dirac sea negative energy 4-holes in the vacuum, where the holes produce negative energy fields and potentials in surrounding spacetime, acting back upon the system which is the source of the 4-holes to produce practical antigravity.

discovery and cautious statement of the excess energy involved in *every* field-particle interaction, and particularly in electrical circuits.

There are several such "white crows" which are legitimate  $COP > 1.0$  EM processes in physics. It only takes one small white crow to prove that not all crows are black. As another example, the papers of Letokhov {157a-157d} are especially recommended. So long as excess energy is received freely from the environment, the system is permitted to be in disequilibrium where  $COP > 1.0$ .

So far as this author could discover, none of the perpetual motion machine critics have noticed another very simple fact: The conventional electrodynamics they utilize to refute  $COP > 1.0$  Maxwellian systems implicitly assumes that the source charge — which is any and every charge in the universe — continuously *creates* and pours out energy in 3-space without any energy input at all. Their own conventional classical electrodynamics contains a "perpetual motion machine assumption" of the most fundamental and grossest kind. The ardent skeptics of overunity EM systems — in using that implicit conventional assumption — are themselves the greatest perpetual motion advocates of all, though perhaps unwittingly. In 2000 we resolved that long-vexing problem<sup>52</sup> of the source charge {12}.

The more strident critics simply set up the "equilibrium thermodynamics" straw man, then knock it down and attack independent  $COP > 1.0$  experimenters with it, erroneously implying that all overunity researchers seek such in an equilibrium system. They fail to notice orthodox science's implied assumption that every charge and every dipole in the universe is already assumed to be a  $COP \Rightarrow \text{inf.}$  perpetual motion machine, freely *creating* all that continuous outpouring of energy from nothing. None of the critics have noticed and critiqued this greatest of all perpetual motion assumptions right in their own ranks, without a single exception, and the most ubiquitous. Undoubtedly that is because the scientific community honestly and freely admits that it has not heretofore solved that problem {68}, and also points out that the outpouring of energy is an experimental fact and therefore unquestionable.

The better critics — at least the rational ones such as Angrist — already admit that there exists a class of legitimate "fictitious perpetual motion

<sup>52</sup> After publication of our paper, we also discovered very powerful support for our solution in quantum field theory. E.g., see F. Mandl and G. Shaw, *Quantum Field Theory*, Wiley, 1984/1993, Chapter 5.

machines" which are powered continuously without the operator inputting the energy. The phrase "fictitious perpetual motion machine" is an attempt to retain the classical thermodynamics straw man, when dealing with the thermodynamics of a system far from equilibrium in its energy exchange with its active environment. That phrase has been a non sequitur since the award of the Nobel Prize to Ilya Prigogine in 1977. We stress again our new use of all EM systems as open systems, in accord with general relativity.

So when rigorously analyzed from the breadth of physics and thermodynamics, and not just from a selected very narrow portion, the entire "perpetual motion" critical literature is inappropriate or — more exactly — is inappropriately focused upon a fictitious or false target. It is simply a classic example of reasoning from a false premise.

Not one such critic seems to have noticed that every generator and battery already pours out more energy than what is input to the shaft, and that it is easily proven experimentally via the thousands of experiments showing negative absorption from the medium. None seems to have bothered to read the original Heaviside, Poynting, and Lorentz papers to see how this startling fact was buried more than a century ago.

Finally, a self-appointed "expert" who does not even know what furnishes the energy to power every electromagnetic circuit, cannot be taken seriously in his "learned criticism" , regardless of what journal publishes it. If he continues to accept the unsolved source charge problem, implying that all charges freely create EM energy from nothing, he is not expert in any facet of powering electromagnetic systems and circuits.

### **2.1.8 Prescribed Systems Versus Changes to Maxwell's Equations**

As we stated, Maxwell's theory {20} was some 20 quaternion-like and vector equations in some 20 unknowns. By discarding the scalar component of the quaternion to retain only the vector subcomponent, and by discarding many of Maxwell's potentials, Heaviside {158} truncated the Maxwell equations to essentially the present familiar set of four vector equations - or in potential form, to two equations with variables unseparated.

While this truncation discarded a great deal of Maxwellian electrodynamics phenomenology, from a thermodynamics view the resulting *Maxwell-Heaviside* equations still contain and prescribe two types of Maxwellian systems:

- (1) systems in equilibrium with their active environment, such as the active vacuum, and
- (2) systems far from equilibrium with their active environment, such as the active vacuum.

Systems in the first class of Maxwell-Heaviside systems — i.e., in equilibrium in their energetic exchange with their active environment — rigorously obey classical equilibrium thermodynamics {159}. No system in that Maxwellian class can output more energy than the operator himself inputs to the system. The greatest coefficient of performance (COP) that these systems can accomplish, is  $COP = 1.0$  for a theoretically perfect system without internal losses whatsoever, and thus with 100% efficiency of conversion of their input energy into work in the load. Since any real system has internal losses and thus is less than 100% efficient, the *practical* systems of this first class exhibit  $COP < 1.0$ .

These Maxwellian systems of the first class are the electrical systems always "understood" by ardent skeptics who proclaim that no other kind of Maxwellian system exists, that therefore no Maxwellian system can exhibit  $COP > 1.0$ , and that a claim to  $COP > 1.0$  is perpetual motion lunacy and not science at all. These fellows often launch scathing and unjustified personal attacks upon any serious researcher trying to work with that second class of permitted Maxwellian systems! It would be scientifically beneficial if these self-appointed defenders of the faith would simply study some more physics and thermodynamics, review the history of Maxwell's theory and how it was altered, and understand the well-established thermodynamics of systems far from equilibrium.

This false charge — that there can be no  $COP > 1.0$  EM system because that would violate the laws of physics and the laws of thermodynamics — has been insidiously indoctrinated into generation after generation of physics and electrical engineering students. Today most of our electrical engineers and electrical scientists have absorbed it and believe it without question. Our power-engineering scientists believe it, and so advise the government. Hence our government believes it on the advice of our best scientists, such as the National Academy of Sciences and the National Science Foundation. Our great national laboratories also believe it and are just as mentally conditioned. The universities — especially the electrical engineering departments — also believe it, and provide a mainstream suppression of the sharp young graduate students and post-docs that would otherwise have long ago revised this mess and solved the energy crisis permanently.

Again we are reminded of that first quotation by Einstein, which we included at the beginning of Chapter 1, and which admonished us to ever examine the foundations of our science to root out and correct the errors. We are also reminded of another quote by Tolstoy:

*"/know that most men, including those at ease with problems of the greatest complexity, can seldom accept even the simplest and most obvious truth if it be such as would oblige them to admit the falsity of conclusions which they have delighted in explaining to colleagues, which they have proudly taught to others, and which they have woven, thread by thread, into the fabric of their lives. "* [Count Leo Nikolaevich Tolstoy].

The second class of Maxwell-Heaviside systems — rigorously prescribed and permitted by Heaviside's truncated Maxwellian theory — is comprised of systems in disequilibrium with their active environment. A system in this class does not obey classical equilibrium thermodynamics. To the contrary, this system obeys the well-known *thermodynamics of systems far from equilibrium* {160a-160f} with their active environment — such as the active vacuum.

Such a system *is permitted to*:

- (i) self-order,
- (ii) self-oscillate or self-rotate,
- (iii) output more energy than the operator himself inputs and thus exhibit  $COP > 1.0$  (the excess energy is freely received by the system from its external active environment),
- (iv) power itself and its load simultaneously (all the energy is freely received by the system from its external active environment,<sup>53</sup> without any operator energy input being required), and

<sup>53</sup> We accent the concept of the supersystem. consisting of three components: (a) the system and its dynamics, considered as in normal electrical engineering (with a flat spacetime and an inactive local vacuum), (b) the active local vacuum and its dynamics, and (c) the active local curvatures of spacetime and their dynamics. All three components of the supersystem interact with each other. In conventional electrical engineering, the assumption in U(1) electrodynamics of a flat local spacetime and equilibrium with the local vacuum exchange eliminates any

- (v) exhibit negentropy, which every charge and every dipole in the universe already does {12, 68}.

Let us now see why Maxwellian EM systems of the second class *are not being designed and built as such*, even though they are permitted by the laws of physics and reinterpreted thermodynamics, and even though they are prescribed in the Maxwell-Heaviside equations before further truncation by Lorentz {161a, 161b}. We may use the Maxwell-Heaviside equations in vacuum, because the energy flow intercepted by the external circuit pours out of the generator terminals and fills all space surrounding the power lines. It is therefore a transmission-reception problem, prior to the "potentialized current-transport" problem in the circuit.

## 2.2 Lorentz Regauging of the Maxwell-Heaviside Equations

### 2.2.1 Introductory remarks.

The domain of Lorentz's symmetrically regauged equations is only a small subset of the domain of the Maxwell-Heaviside equations they replace. Indeed, the later Lorentz {161a, 161b} symmetrical regauging discards an entire class of Maxwellian systems permitted by nature and by the Maxwell-Heaviside equations before they are symmetrically regauged.

Lorentz's symmetrically regauged EM equations discard all Maxwell-Heaviside systems that are far from equilibrium in their energetic exchange with the active vacuum. They retain only that subset of the Maxwell-Heaviside theory wherein the system being described is in forced equilibrium {162} in its exchange with its active vacuum environment. Hence the present Lorentz-Maxwell-Heaviside theory, by which EM circuits and electrical power systems are designed, produces only systems in self-forced equilibrium with the active vacuum, *specifically during the symmetrically regauging discharge* of the circuit's excitation energy. The closed current loop circuit in fact discharges half its collected energy to destroy the source dipole in the generator, thereby destroying that dipole's extraction from the vacuum and furnishing of the energy flow pouring out of the terminals. These circuits kill themselves faster than they can power the load, and they use more energy to kill the energy flow from the vacuum than they use to power their load. Hence all present EM systems

disequilibrium of the system with its active environment, hence arbitrarily discards all Maxwellian disequilibrium systems - precisely those that can exhibit  $COP > 1.0$ .



rigorously conform to classical equilibrium thermodynamics, and exhibit a coefficient of performance (COP) of  $COP < 1.0$  since any real system also has losses {163}.

### 2.2.2 Technical regauging of the Maxwell-Heaviside equations {164}.

For asymmetrical-regauging (A-regauging) considerations, we are speaking of A-regauging the potential energy in and around a circuit. We include not only the Poynting energy flow component that is diverged into the circuit conductors, but also the remaining Heaviside *nondiverged* energy flow in space surrounding the conductors. This means that the energy is in field energy (E-field and B-field) form, both overtly as ordinary EM fields and covertly or "infolded" inside the corresponding scalar potentials {165, 166, 167, 168}, or both. Consequently, we must analyze Maxwell's equations as we would for radiating energy, rather than employ only the  $\mathbf{j}\phi$  circuit analysis conventionally utilized, where the collected energy is sluggishly transported by the Slepian vector  $\mathbf{j}\phi$ . We show in this book that asymmetrical self-regauging (ASR) allows permissible overunity operation of electromagnetic engines and devices {169}, if other requirements are fulfilled also.

In Gaussian units, Jackson {170} shows that Maxwell's four equations (vacuum form) can first be reduced to a set of two coupled equations in the  $(\mathbf{A}, \Phi)$  representation as follows:

$$\nabla^2 \Phi + \frac{1}{c} \frac{\partial}{\partial t} (\nabla \cdot \mathbf{A}) = -4\pi\rho \quad [15]$$

$$\nabla^2 \mathbf{A} - \frac{1}{c^2} \frac{\partial^2 \mathbf{A}}{\partial t^2} - \nabla (\nabla \cdot \mathbf{A} + \frac{1}{c} \frac{\partial \Phi}{\partial t}) = -\frac{4\pi}{c} \mathbf{J} \quad [16]$$

The result is two coupled Maxwell equations rather than four. Jackson shows that potentials  $\mathbf{A}$  and  $\Phi$  in these two equations are arbitrary in a specific sense, since the  $\mathbf{A}$  vector can be replaced with  $\mathbf{A}' = \mathbf{A} + \nabla\Lambda$ , where  $\Lambda$  is a scalar function and  $\nabla\Lambda$  is its gradient. The  $\mathbf{B}$  field is given by  $\mathbf{B} = \nabla \times \mathbf{A}$ , so that the new  $\mathbf{B}'$  field becomes

$$\mathbf{B}' = \nabla \times (\mathbf{A} + \nabla\Lambda) = \nabla \times \mathbf{A} + \mathbf{0} = \nabla \times \mathbf{A} = \mathbf{B} \quad [17]$$

In other words, the  $\mathbf{B}$  field has remained entirely unchanged, even though the magnetic vector potential has been asymmetrically changed. However, if no other change were made, then the electric field  $\mathbf{E}$  would have still been changed because of the gradient  $\nabla\Lambda$ . In that case the net change would be asymmetrical, because one obtained a "free" E-field which could

then do work on the system — either beneficially or detrimentally, depending upon the specific conditions, geometry, and timing. To prevent this excess "free" E-field from appearing, the electrodynamicists simultaneously and asymmetrically regauge (transform) the scalar potential  $\Phi$  so as to offset the E-field change due to the regauging of equation [15]. In short, they also change  $\Phi$  to  $\Phi'$ , where

$$\Phi' = \Phi - \frac{1}{c} \frac{\partial \Lambda}{\partial t} \quad [18]$$

With that additional change, now the net E and B fields remain unchanged {171, 172}, even though both potentials have changed and the fundamental stored energy of the system has changed, as has the stress of the system. Unchanged force fields just mean that only a set of zero-summation forces (a zero-summed stress system) has been utilized to effect the change in potential energy. It also means that the net summation of the two *asymmetrical* regaugings has been entirely *symmetrical* {173}.

Jackson points out that, conventionally, a set of potentials ( $\mathbf{A}$ ,  $\Phi$ ) is habitually and *arbitrarily* chosen by the electrodynamicists such that

$$\nabla \cdot \mathbf{A} + \frac{1}{c} \frac{\partial \Phi}{\partial t} = 0 \quad [19]$$

This *net symmetrical* regauging operation creates a new and simpler Maxwellian system, with different system stress and different system potential energy. It successfully separates the variables, so that two inhomogeneous wave equations result. This procedure yields a new and simplified system, and the new Maxwell's equations for it are as follows:

$$\nabla^2 \Phi - \frac{1}{c^2} \frac{\partial^2 \Phi}{\partial t^2} = -4\pi\rho \quad [20]$$

$$\nabla^2 \mathbf{A} - \frac{1}{c^2} \frac{\partial^2 \mathbf{A}}{\partial t^2} = -\frac{4\pi}{c} \mathbf{J} \quad [21]$$

The two previously coupled Maxwell equations [15] and [16] (potential form) have been replaced by equations [20] and [21], to leave two much simpler inhomogeneous wave equations, one for  $\Phi$  and one for  $\mathbf{A}$ . These are *new equations for a new system!*

Of course, this arbitrary *net symmetrical* regauging (let us use the term **S-regauging**) is quite useful for purposes of simplifying the theory and for

easing calculations. But its unquestioning and rather universal usage has arbitrarily eliminated the freedom of the system designer to *asymmetrically* regauge the system's potentials, and *use* the resulting excess free force fields to change the stored energy in the system without the operator performing extra work upon the system. So we advance the condition for violating this S-regauging, violating the exclusion of net A-regauging, and violating the "frozen gauge" process as

$$\nabla \cdot \mathbf{A} + \frac{1}{c} \frac{\partial \Phi}{\partial t} \neq 0 \quad [22]$$

Any regauging of the potentials that complies with equation [22] will *a priori* produce one or more net excess forces in the system, as well as a change in potential energy of the system. By controlling the regauging, the system designer is then able to control where, how, and when these excess forces appear, and whether they enhance the system's operation or hinder it. These net forces can then be used to perform work and dissipate the excess potential energy taken on in the asymmetrical regauging. That is what we do when we ourselves add potential (and potential energy) to an EM system to enable it to do work! *If we always have to asymmetrically regauge the system to get it to do subsequent work, why do we not just let the system asymmetrically regauge itself so we get the input energy freely and also get the resulting work freely?* The gauge freedom axiom in quantum field theory assures us that nature will indeed freely change the potential energy of any system for us, if we but arrange it and permit it.

In short, we have had a gauge freedom principle for some time, which guarantees us that COP > 1.0 EM systems are permitted and possible. Yet we have failed to realize it, or take any advantage of it. So we continue to pay to asymmetrically regauge (potentialized) all electrical power systems, and to insure that we have to continue to do it, we specifically design the systems so they will then re-enforce Lorentz's symmetrical regauging condition.

This is another of those "inexplicable aberrations of the scientific mind" referred to by Nikola Tesla!

### 2.2.3 A Humorous Comment but an Exact Analogy

Again see Figure 1-1 in Chapter 1, and see Figure 2-3. In Figure 2-3, we show how Lorentz's integration trick {174a, 174b} discarded the huge nondiverged Heaviside component of energy flow outside the conductor, while retaining the small Poynting component that strikes the surface charges and gets diverged into the conductor to power the electrons. In

justifying his integration trick, Lorentz stated that all the rest of that wasted Heaviside energy flow

See Panofsky & Phillips  
Classical Electrodynamics and Magnetism, 2nd edn  
 Addison Wesley 1962.  
 p. 178-181

The Lorentz procedure arbitrarily discards the enormous Heaviside component that misses the circuit entirely and is wasted. This results in a non sequitur of first magnitude in EM energy flow theory

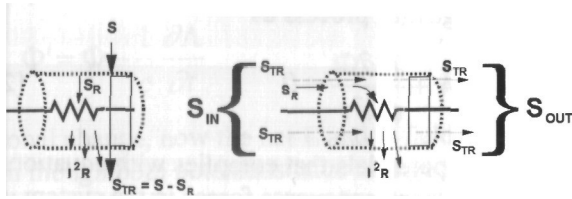

2-3a. Lorentz surface integration

2-3b. Actual S in and S out.

Figure 2-3 Lorentz's integration trick to discard the enormous Heaviside non-diverged energy flow component

The Heaviside component is often 10 trillion times the Poynting component but is simply wasted in ordinary single-pass energy flow circuits

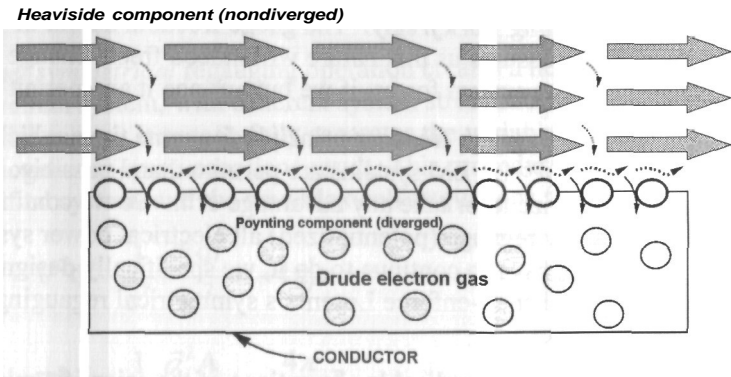

Figure 2-4 Heaviside nondiverged and Poynting diverged energy flow components.

(Figure 2-4) was "physically insignificant" (his term) because it did not strike the circuit, was not intercepted, and did not power anything. Well, Maxwell's theory is a material fluid flow theory, so let us evaluate Lorentz's justification in a fluid flow analogy.

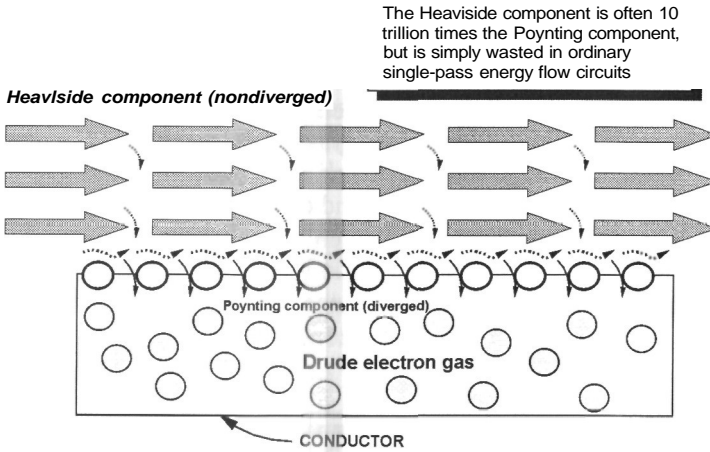

Figure 2-4 Heaviside nondiverged and Poynting diverged energy flow components.

Contrast Lorentz's statement if applied to the ocean wind on a sailing ship, where the wind represents the total energy flow and the ship represents a single Maxwellian system under consideration.

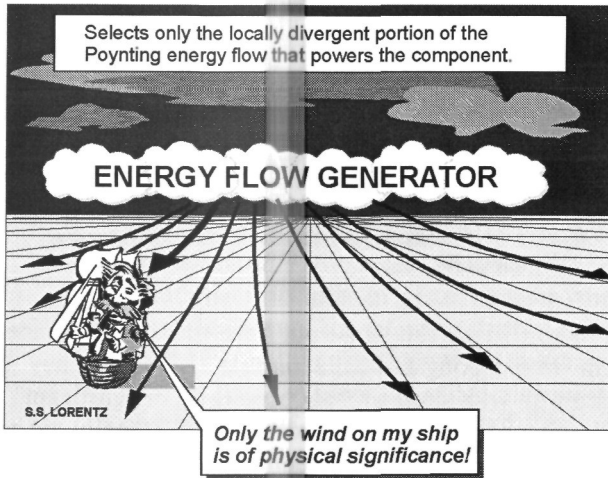

Figure 2-5 Lorentz in his sailing ship in an ocean wind, with no other ships around.

As shown in Figure 2-5, Lorentz's argument is analogous to stating that the huge component of the wind *that does not* strike the ship's sails is "physically insignificant" — in other words, it has no physical use. Now that is true for the single ship under consideration, as shown in Figure 2-5. None of that wind component that misses the ship's sails does anything at all to power *that ship* (that individual system). Hence it is indeed physically insignificant *to that ship itself*. Of course, if we flare the sails wider, the ship will catch more wind and develop more power. That is an analogy to the Bohren experiment, which resonates the charges (the "sails" intercepting the incoming EM energy flow "wind") so that they sweep out a greater geometrical cross section. Hence 18 times as much energy is caught, as when the charges are not resonated (the sails are not flared to a greater area).

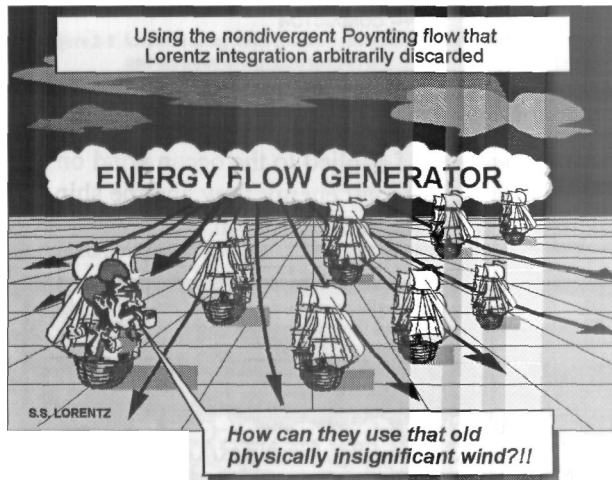

Figure 2 6 Lorentz in his sailing ship in an ocean wind, with many other ships alongside.

However, now see Figure 2-6. If we put some more ships (some more systems) with "intercepting and collecting sails" in there, they will be powered quite well with some of that "physically insignificant" wind. So Lorentz (following earlier work by Ludwig Lorenz) really did advance and impose upon electrostatics a non sequitur of first rank.

And the wind-fluid analogy helps to "lighten things up" a bit here and inject a little good-natured humor!

### 2.2.4 Discussion

Equation [22] has now become the first *necessary but not sufficient* principle of asymmetrical self-regauging (ASR) for overunity electromagnetic engines and devices. That is, we are now free to A-regauge in a *nonconservative* field manner, where excess net force fields automatically appear and remain for our use in the system. All that remains is for the designer to:

- (i) evoke "nonconservative" (asymmetrical) regauging in accord with equation [22];
- (ii) have the system assembly in disequilibrium with its energetic external environment, so that the system itself performs this nonconservative A-regauging in some sector or part {175} of its normal operation,
- (iii) insure that any "free force" that is produced and allowed to do work upon the system will do some positive work upon the system, so as to increase its collected energy, and
- (iv) assure that the "free" forces that are otherwise produced by the circuit design (this includes, e.g., the back emf) do not seriously degrade the system (i.e., do not substantially reduce its energy available to dissipate as work in the load). Usually this means that, contrary to the standard closed current loop circuit, the circuit must not dissipate half its collected Poynting energy to dissipate the charges in the source dipole and destroy it. *These four considerations we now advance as the primary or master principles of asymmetrical self-regauging of electromagnetic engines and devices for permissible overunity efficiency.* We will meet additional principles in a later chapter when we discuss what the form of the energy output of an overunity EM system is, and the considerations for close-looping a COP>1.0 EM system into stable disequilibrium and continuous self-powering.

It is understood that the asymmetrical regauging portion of the circuit or system must be a broken symmetry in the energetic exchange between the active vacuum environment and that portion of the system. We exclude, g., solar cell-powered systems, windmill-driven generators, etc.

For simplicity, the system designer may wish to A-regauge only one potential, producing a desired "free" force  $F_1$  to work on the system and increase its energy, while allowing any other extraneous force  $F_2$  to appear, but just "bottling up" that additional force  $F_2$  so that it cannot do any work at all on the system and therefore cannot degrade the system's operation. A most useful ASR corollary that immediately suggests itself is to simply A-regauge onto that force operation that normally produces the back-drag in a system or device, to either *eliminate* the back-drag altogether or reverse its algebraic sign so that it becomes an *assisting* force instead of a *hampering* force {176}.

In overunity systems, this becomes a startling and unexpected exercise in novel new phenomenology effected by tempic potential differences, tempic force, etc. It involves not only the system, but also the entire *supersystem* consisting of the physical system, its associated altered local vacuum, and its associated curved local spacetime. See Chapter 9 for our expose of these phenomena, and how one must transduce<sup>54</sup> the effects of a very novel kind of tempic force back emf, if the  $COP > 1.0$  system is to remain in disequilibrium with the active vacuum and thus maintain its stable  $COP > 1.0$  operation.

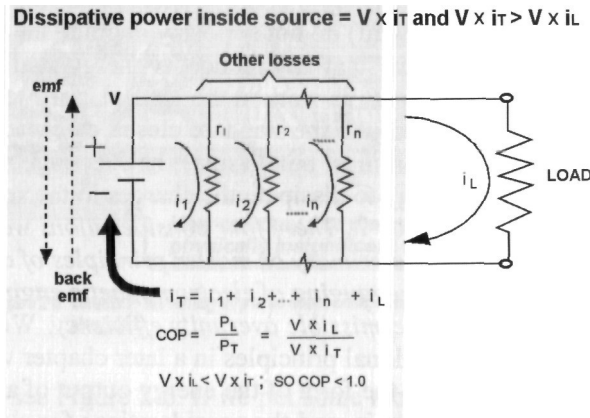

**Figure 2-7 Why a conventional closed current loop circuit is limited to  $COP < 1.0$ .**

Again see Figures 2-3 and 2-4, and equations [20] and [21]. Electrodynamicists have previously *assumed away* the capability of work-

<sup>54</sup> A patent application on the process has been filed by John Bedini and the present author.



free "refueling" of an electromagnetic system directly from the local vacuum {177}. They have deliberately designed their systems *to prevent self-evoking and positively utilizing asymmetrical self-regauging of their own potential energy during system excitation discharge.* (See Figure 2-7).

In fact, by forcibly pumping the ground electrons from the external circuit back up through the primary source dipole in the generator or battery, our closed current loop circuits self-enforce the Lorentz condition and require that precisely half the regauging energy freely intercepted and collected in the external circuit is used to destroy the source dipole providing the regauging energy. This destruction of the energy source is accomplished faster than the external load is powered. Hence all such systems with losses are COP<1.0 systems. For more than 100 years, this "self-destroying, suicidal system" is the only kind of electrical power system our energy scientists and engineers have designed and built. To inject a little humor, we can only describe this in Tesla's words<sup>55</sup> as "*one of the most remarkable and inexplicable aberrations of the scientific mind which has ever been recorded in history.*"

Thereby electrodynamicists have narrowed the inherent flexibility of the Maxwellian EM gauge theory model to an artificially symmetrized subset of Maxwell-Heaviside-Lorentz equations that utilize a single fixed gauge. This prohibits the free use of the system's vacuum energy freely received by the source dipole's broken symmetry in its violent exchange with the active vacuum. If the system increases its dipolarity (regauges freely), it simultaneously increases the speed at which it destroys the dipolarity! *Maxwell's equations themselves do not require this, and neither does Heaviside's truncation of them into the resulting Maxwell-Heaviside equations. Lorentz's symmetrical regauging of the Maxwell-Heaviside equations does require it.*

The Maxwell-Heaviside theory without Lorentz symmetrical regauging allows regauging asymmetrically to place the system in disequilibrium so that it freely receives and utilizes excess energy from the surrounding vacuum. Then it can again asymmetrically regauge by dissipating that freely received energy in an external load. *The theory specifically does not require destroying the primary source dipole as is done in the arbitrary closed current loop circuit between load and primary source dipole in the generator or battery.*

" Nikola Tesla, "The True Wireless, *Electrical Experimenter*, May 1919.

By arbitrary habit, electrodynamicists have discarded the Maxwell-Heaviside major EM overunity mechanism: *Asymmetrically self-regauging accomplished by the system itself, without requiring external work being done on the system by the operator*, in order to freely gather in and collect excess potential energy in the system from its broken symmetry with its active vacuum environment. In this self-A-regauging, associated *excess net force* does appear, whereupon that excess collected/stored regauging energy can then be used to "drive" the forces against load resistance and system losses to freely power the system and its loads {178}. They have also discarded the major overunity corollary whereby the designer is free to utilize *system self-regauging asymmetrically so that the normal back-drag or back-emfwork — usually done upon the system in its closed current loop configuration to reduce its kinetic energy — vanishes or reverses sign and becomes beneficial work done in the opposite sense, to freely increase the energy of the system.*

The failure to do this is bluntly met with, when one does succeed in producing a  $COP \gg 1.0$  system momentarily by suddenly and very powerfully breaking the system's equilibrium in its vacuum energy exchange. Nature then exhibits a very novel kind of Dirac sea hole reaction (powered by tempic force generated in the locally curved spacetime and resulting effects generated in the altered semiconducting vacuum). This reaction sharply jerks the system (or the system plus its external power supply) back into equilibrium and  $COP < 1.0$  operation. In Chapter 9, apparently for the first time in the literature<sup>56</sup> we present this novel mechanism exhibited by nature as a new kind of "tempic back emf phenomenon in systems in disequilibrium. We also explain how to handle the problem and in general how to use it for "freeze-framing" and stabilizing the system's disequilibrium operation in sustained  $COP > 1.0$  configuration while powering itself and its load.

All that is required for "self-powering"  $COP \gg 1.0$  EM engines directly powered by the vacuum, is that (1) initially the engine must asymmetrically self-regauge to produce  $COP \gg 1.0$ , and (2) positive *transduced* feedback (from the output) of a very special and previously unknown kind — where negative energy is transformed into normal electron current and energy — must be utilized to its input, in a clamped

<sup>56</sup> The basis for it, however, is in Dirac's electron theory published in 1930, nearly three quarters of a century ago. See P. A. M. Dirac, "A theory of electrons and protons," *Proceedings of the Royal Society of London, Series A*, 126(801), Jan. 1, 1930, p. 360-365.

and controlled fashion {179}. The clamped positive feedback can be designed and applied, once the fundamental engine is designed for self-regauging and overunity efficiency, and once the novel feedback and transformation requirements are understood and incorporated. The remaining excess output can then be utilized to power loads, while the engine seemingly "powers itself."

We stress, of course, that this system is just analogous to the windmill, and it continuously receives a "free energy wind" from its active environment. The conservation of energy law is obeyed at all times, as are physics and thermodynamics.

In a later chapter we present the concepts and processes for these novel phenomena involved in close-looping a  $COP > 1.0$  system for self-powering operation.

### 2.3 The Suicidal Closed Unitary Current Loop Circuit

The present Lorentz-Maxwell-Heaviside theory, by which EM circuits and electrical power systems are designed, produces only systems in net usable equilibrium with the active vacuum, specifically during the symmetrically regauging discharge of the circuit's excitation energy (Figure 2-7). Hence all present EM systems designed by that model rigorously conform to classical equilibrium thermodynamics, and exhibit a coefficient of performance (COP) of  $COP < 1.0$ .

Since the Maxwell-Heaviside equations do not restrict the designer to systems in equilibrium with their active environment, some ubiquitous characteristic of the standard circuit approach must be self-enforcing the Lorentz symmetrical condition as far as using any excess free potential energy of the system to freely power loads. That is the closed-loop circuit, as we have discussed. Let us now illustrate what goes on in such a circuit.

Taking into account Figure 2-4, Figure 2-8 shows a modified diagram of what is actually happening between the vacuum and the dipole to power the circuit. Figure 2-9 shows how a pair of conductors constitutes an extended series of parallel dipoles. Once the dipole is formed by dissipating some chemical energy in the battery, the dipole extracts energy from the surrounding vacuum and pours it out of the battery terminals, producing an energy flow filling space around the conductors of the external circuit. Only a very small portion (Figure 2-4) of the very large energy flow is intercepted by the external charges in the conductors, and diverted into the conductors to power up the Drude electrons.

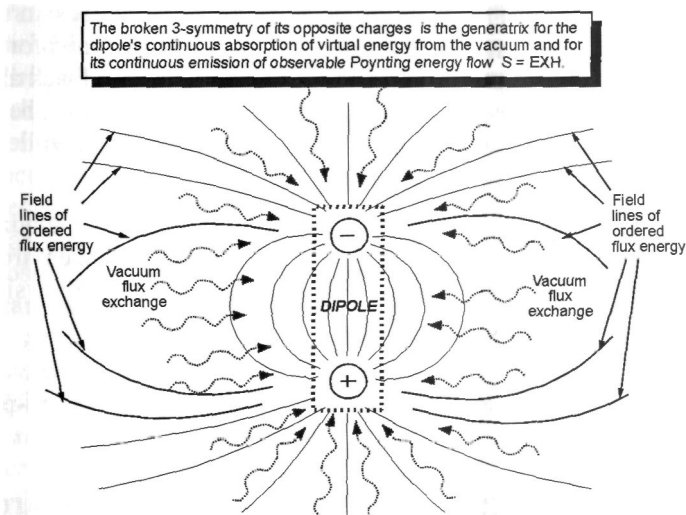

Figure 2-8 Virtual photon flux exchange intensity with the charges of a dipole.

As can be seen from Figure 2-7, half of the energy collected upon the internal electrons to drive them as  $\mathbf{j}\phi$  is expended as work required to pump the spent electrons from the ground return wire back through the source dipole in the battery. This scatters the charges of the dipole (in this case, by changing the chemistry of the battery plates) and destroys the dipole. The other half of the collected energy is dissipated in the external circuit's losses and in the load.

Then some more chemical energy has to be dissipated by the battery to perform work upon the internal charges and restore the dipole (in this case, to change the plate chemistry of the battery plates). So even if this process is 100% efficient, the battery has to dissipate as much chemical energy as was electrically dissipated upon those former dipole charges to scatter them and destroy the dipole.

In Figure 2-7, we show the small internal resistance of the conductors, as well as the load resistor. Half the energy dissipated by  $\mathbf{j}\phi$  is expended just to forcibly ram the spent electrons back through the back emf of the source dipole. The other half is expended in the circuit's internal losses and in the load resistance. Therefore, less energy is expended as usable work in the resistive load than is expended to destroy the dipole and cut off the flow of free EM energy from the vacuum.

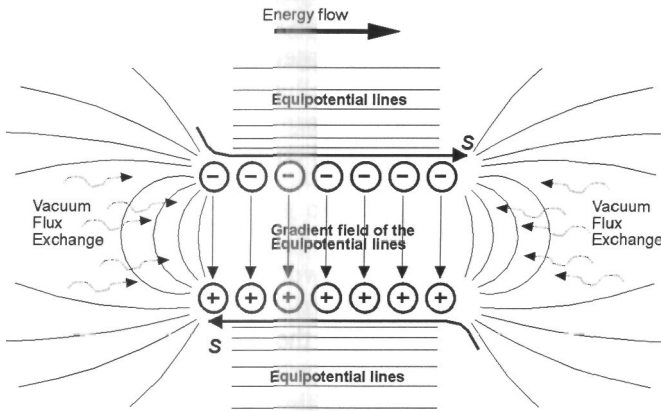

Figure 2-9 Paired conductors as an extended set of dipoles.

The battery has to input as much energy to restore the dipole as was used to destroy it. The battery has to expend at least as much chemical energy as equals half the entire energy originally collected in the external circuit and expended as  $\int j(t)\phi(t)dt$ . It must expend chemical energy  $CE \geq \frac{1}{2} \int j(t)\phi(t)dt$ . The energy  $RE$  dissipated as work in the load resistor  $R$  is  $RE < \frac{1}{2} \int j(t)\phi(t)dt$ . Thus  $CE > RE$ , and this system is forced to exhibit

$$COP \circ \frac{RE}{CE} = \frac{< \frac{1}{2} \int j(t)\phi(t)dt}{\frac{1}{2} \int j(t)\phi(t)dt} \text{ } \text{ } COP < 1.0 \quad [23]$$

As can be seen, this system symmetrically regauges itself during its excitation discharge, so that it self-enforces the Lorentz condition during that period. The circuit self-enforces  $COP < 1.0$ , even though all the energy — both the energy powering the external circuit and also destroying the internal source dipole in the battery to enforce the Lorentz condition during discharge — is freely received from the active vacuum via the broken symmetry of the source dipole,<sup>57</sup> once established, in its energetic exchange with the active vacuum.

<sup>57</sup> The broken symmetry of opposite charges is one of the broken symmetries predicted by Lee, {13a} and by Lee, Oehme, and Yang, {13b}. Broken symmetry was proven experimentally in early 1957 by Wu *et ai*, {14}. So profound were the implications for physics that the Nobel Prize was awarded to Lee and Yang in latter 1957, the same year! E.g., see T. D. Lee, "Weak Interactions and Nonconservation of Purity," Nobel Lecture, Dec. 11, 1957 in *T. D. Lee, Selected Papers*, Gerald Peinberg, Ed., Birkhauser, Boston, 1986, Vol. 1, p. 32-44.

The problem is that *the source dipole is destroyed faster than the load is powered*, as shown in Figure 2-7. Because of the inexplicable scientific pre-occupation with the conventional closed current loop circuit, the planet and biosphere have been increasingly polluted for more than a century, by burning more hydrocarbons, building more dams, using more nuclear fuel rods, etc. to provide ever more electrical energy.

## 2.4 In Summary

COP>1.0 operation in EM systems via work-free *asymmetrical* regauging has been inherent in the Maxwell-Heaviside equations for more than a century. Since Lorentz first did so circa the latter 1880s, electrodynamicists have just conveniently and arbitrarily *assumed away* COP>1.0 systems by (i) artificially limiting the theory to only that fraction of Maxwell-Heaviside systems in usable net force field equilibrium in their vacuum exchange during their excitation discharge, and (ii) using the ubiquitous closed current loop circuit to self-enforce the Lorentz symmetry condition during that excitation discharge. In other words, our engineers have only been building systems which self-enforce the overly restricted Lorentz-regauged theory.

Electrodynamicists have never seriously tried to build overunity circuits, nor until recently have they explored the discarded Maxwellian systems by removing the Lorentz regauging condition and examining EM energy from the vacuum.<sup>58</sup>

<sup>58</sup> Under the directorship of Dr. M.W. Evans, the Alpha Foundation's Institute for Advanced Study (AIAS) has been gradually developing the physics of EM systems far from equilibrium with their active environment (the local active vacuum and local curved spacetime). Some of the papers of interest are: M. W. Evans et al., "Derivation of the Lehnert field equations from gauge theory in vacuum: Space charge and current," *Found. Phys. Lett.*, 13(2), Apr. 2000, p. 179-184; Evans et al., {38b}, {38c}, {113b}, {233a}, {233b}, {233e}; {233g}, {233j}; Evans et al., "Schrodinger Equation with a Higgs Mechanism: Inherent Vacuum Energy," *Found. Phys.* (in review); — "Vacuum Energy Flow and Poynting Theorem from Topology and Gauge Theory," *Physica Scripta* (in review); — "Energy from the Vacuum," *Physica Scripta* (in review); — "Some Notes on Asymmetric Regauging", *J. New Energy* 4(3), Special Issue, Winter 1999, p. 325-326; — "Inconsistencies of the Maxwell-Heaviside Theory of Electrodynamics: The Aharonov-Bohm Effect," *J. New Energy*, 4(3), Special Issue, Winter 1999, p. 236-240; — "Spontaneous Symmetry Breaking as the Source of the Electromagnetic Field," *Found. Phys. Lett.* (in press), A monumental work. *Modern Nonlinear Optics*, Second Edition, 3 vols., ed. M. W. Evans, Wiley, 2001 gives a broad coverage of higher group symmetry electrodynamics and energy from the environment (the local active vacuum and the

Every electrical power system ever built is and has been powered by electrical energy freely extracted from the seething vacuum exchange with the source dipole in the system, due to that dipole's broken symmetry. But the engineers and scientists have designed and built only those electrical systems which self-enforce Lorentz's symmetrical regauging.

The time for energy scientists and engineers to correct this procedure and cease this inane practice is long overdue, following the direction pointed out by the AIAS.

local curved spacetime). Some 60 AIAS papers are published as a Special Issue of **the J, New Energy**, 4(3), Winter 1999. More than 100 AIAS papers are also carried on DoE restricted website <http://www.ott.doe.gov/electromagnetic/>.

## Chapter 3

# Giant Negentropy, Dark Energy, Spiral Galaxies and Acceleration of the Expanding Universe

*"... the discoveries made in 1957 established not only right-left asymmetry, but also the asymmetry of the positive and negative signs of electric charge. In the standard nomenclature, right-left asymmetry is referred to as P violation, or parity nonconservation. The asymmetry between opposite signs of electric charge is called C violation, or charge conjugation violation, or sometimes particle-antiparticle asymmetry. " [T. D. Lee]. {180}*

*"The ends of a dipole, being oppositely charged, exhibit charge conjugate symmetry violation. An 'isolated' charge, considered with its clustering virtual charges of opposite sign, also exhibits symmetry violation. " [T. E. Bearden, this book, below].*

*"A generally acceptable, rigorous definition of radiation has not as yet been formulated." ... "The recurring question has been: Why is it that an electric charge radiates but does not absorb light waves despite the fact that the Maxwell equations are invariant under time reversal? " [B. P. Kosyakov]. {181}*

*"It [the energy transfer flow] takes place, in the vicinity of the wire, very nearly parallel to it, with a slight slope towards the wire... . Prof Poynting, on the other hand, holds a different view, representing the transfer as nearly perpendicular to a wire, i.e., with a slight departure from the vertical. This difference of a quadrant can, I think, only arise from what seems to be a misconception on his part as to the nature of the electric field in the vicinity of a wire supporting electric current. The lines of electric force are nearly perpendicular to the wire. Their departure from perpendicularity is usually so small that I have sometimes spoken of them as being perpendicular to it, as*



*they practically are, before I recognized the great physical importance of the slight departure. It causes the convergence of energy into the wire.* " [Oliver Heaviside]. {182}

*"The funny thing about the dark matter is it doesn't show up in light, X-rays, gamma rays, infrared, ultraviolet, radio waves, or submillimeter. We're running out of places to look for it."* [William Keel]. {183}

*"... baryonic, ordinary matter — the stuff of stars and of people — makes up just over 4% of the energy and matter in the universe. ... about 30% of the stuff in the universe is dark [unobserved] matter. The remaining two-thirds, theorists believe, is a mysterious 'dark energy' or 'quintessence' — a large-scale antigravity-like effect that is making the universe expand ever faster.... "* [Charles Seife]. {184}

*"And yet, curiously enough, we do not know exactly what charge is, only what it does. Or, equally significantly, what it does not do."* [M. P. Silverman]. {185}

*"**Charge** is the ongoing circulation of EM energy flow between the time and 3-space domains, as seen by the observer. Negative charge is the ongoing absorption of EM energy input from the time domain (from ict), transduction of the absorbed energy into 3-space EM energy, and re-emission of the EM energy in all directions in 3-space. **Positive charge** is the ongoing absorption of EM energy input from 3-space, transduction of the absorbed energy into the time domain, and re-emission of the EM energy in the time domain. If we wish, we may also consider the positive charge as radiating negative energy, while the negative charge radiates positive energy. Once we consider vacuum polarization, we recognize that this circular flow process is involved at each "dipolar point" of the polarized vacuum. "* [T. E. Bearden, this book, below].

*"The matter density of the Universe is extremely low. On average there might be one atom per cubic metre of space. The major constituent of the Universe is believed to be some kind 'dark energy', which is pushing the Universe apart. "* [Matthew Colless]. {186}

### 3.1 Broken 3-Symmetry of the Dipole

To recap from Chapters 1 and 2: In 1956, Lee and Yang {187} strongly predicted broken symmetry in physics, suggesting experiments to detect it in the weak interaction. In early 1957, Wu *et al.* {188} experimentally demonstrated broken symmetry, thus furnishing the experimental substantiation of broken parity in the weak interaction. The emergence of broken symmetry was such a dramatic change to the view of physics, that in December of the same year, 1957, Lee and Yang were awarded the Nobel Prize.

One of the asymmetries shown by Lee *et al.* is the asymmetry of opposite charges. That means that a dipole, which consists of slightly separated opposite charges, exhibits broken symmetry in the seething vacuum virtual particle flux. In short, a dipole — any dipole or dipolarity — must absorb or receive virtual photon energy from the active vacuum, integrate at least some of it to observable state, and re-radiate that integrated EM energy in observable form in 3-space.

We stress: *The ends of a dipole, being oppositely charged, exhibit broken symmetry. An 'isolated' charge, considered with its clustering virtual charges of opposite sign, is a set of composite dipoles and also exhibits broken symmetry.*

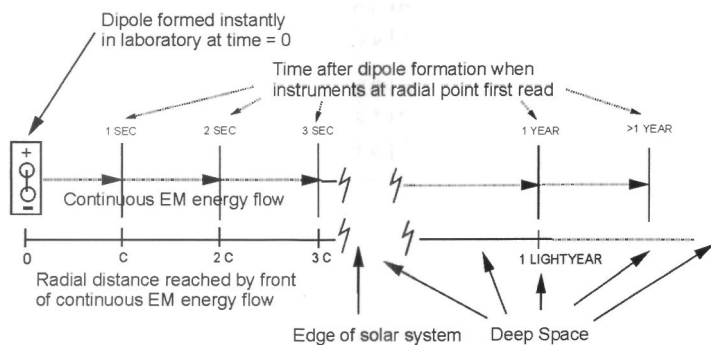

Figure 3-1 The source dipole experiment, demonstrating continuous energy flow.

Let us now consider a gedanken experiment, as shown diagrammatically in Figure 3-1, to illustrate Kosyakov's quotation cited above. At a point in the laboratory corresponding to the origin of a 3-dimensional frame, a dipole is produced instantly by separating charges, such as in a flash-charged capacitor. Along two radial lines in 3-space from that origin, we have

previously placed perfect EM field and potential detectors, at distances  $ct$  apart, where  $t = 1, 2, 3, 4, n, \dots$  and so on in seconds, with the radials extending across the universe, and where  $c$  is the speed of light. We neglect the transient pulse that momentarily occurs at each instrument package, since we are examining steady state conditions.

At the end of one second, the instruments at  $t = 1$  instantly read, and those readings remain thereafter. One second later, the instruments at  $t = 2$  instantly read, and those readings remain thereafter. And so on with each of the instruments progressively farther from the origin reading at the proper light-time travel, and with all field readings then *remaining continuously* thereafter.

This gedankenexperiment demonstrates that what is emitted from the dipole, from its moment of creation at the origin, is a continuous flow of EM energy in all directions in 3-space.<sup>59</sup> This energy continuously flows from the dipole, indefinitely or as long as the dipole physically exists. Other than paying once to initially separate the charges and make the dipole, we have neither added nor input any additional energy. Yet energy continues to flow out from the dipole in all directions, unceasingly, as shown by the continued of the reading on each field energy density instrument, once the leading edge of the energy outpour reaches that instrument and passes it by. In short, the experiment shows that it is not a "pulse" that passes each instrument, but a continuous and sustained flow of EM energy, remaining steadily thereafter so long as the dipole remains.

One year after making the dipole, the instruments at one light year distance suddenly read, and their readings remain. *The energy density of a volume of space one light year in radius has now been changed, and that change in spatial energy density continues to spread outwards at light speed.*

<sup>59</sup> More exactly, what is observed is a spreading change in the energy density and point-like polarization of the vacuum itself, and of the local curvature of spacetime. At each point, once the change of energy density and ST curvature occur, the energy density and ST curvature remain fixed in a new equilibrium condition, steadily fed by the energy radiating from the dipole. See our point made in {181}. The discovery of giant negentropy {12} requires a change in how we view the very process of energy propagating in space. Now it has become a quite different *propagation of energy circulation between time and space domains at each affected point in space.*

Yet there has been no input of *observable 3-space* EM energy flow to the dipole whatsoever, as our instruments also verify. All observable energy flow in 3-space is *outward* from the origin where the dipole is located.<sup>60</sup>

We have shown that the *observable* EM energy flow from a source dipole is not conserved in 3-space, which is consistent with a broken 3-symmetry since symmetry implies conservation. Either we must discard the conservation of energy law altogether, or it must be conserved in 4-space since we have proven the dipole does not conserve energy in 3-space. If we assume that the experiment must conform to the conservation of energy law, then 4-symmetry EM energy flow must exist since 3-symmetry energy flow is broken. The energy steadily pouring out of the dipole in all directions in 3-space must therefore be received by the dipole *charges from the time-domain*,<sup>61</sup> assuming we are working in Minkowski 4-space. In particle physics, this is essentially the same as receiving the energy from the virtual domain, and therefore is consistent with the proven broken symmetry of every dipole and dipolarity.

The energy flow is indeed received from the time domain, as we have argued {189} in a wave manner consistent with (i) quantum field theory as shown by Mandl and Shaw in the photon model {190}, (ii) broken charge conjugation symmetry of particle physics using the virtual photon and observable photon concepts, and (iii) a re-interpretation of Whittaker's decomposition of the scalar potential {191} when applied to the scalar potential between the ends of the dipole {12}.

We state the obvious: A dipole is a Maxwellian system. This gedanken experiment also proves by demonstration that a Maxwellian system — e.g., a dipole — is permitted by the laws of nature, physics, and thermodynamics to output more energy than the operator inputs, since we

<sup>60</sup> Obviously, we are utilizing the prevailing notion of the flow of energy through 3-space, which is actually a non sequitur. No 3-space observable entity can "move" in 3-space alone; it requires time to move, and so any movement is in 4-space a priori. We previously discussed this and the *dldt* operator being applied by the observation process. But for simplicity, we are using the conventional view here, so the negentropy of the dipole can be easily grasped.

<sup>61</sup> Again, we have stated the positive time case only. In the spreading special 4-circulation, energy appears in 3-space at each point dipole from the time domain (courtesy of the action of the negative charge of the dipole), and then returns from 3-space back to the time domain (courtesy of the action of the positive charge, which is a time-reversal of the action of the negative charge).

input nothing to the source dipole<sup>62</sup> once we have made it. After paying to produce the dipole initially, the operator has made no other energy input to the dipole at all, yet the dipole will continue to pour out observable energy in 3-space for the next 14 billion years if the dipole remains and is not destroyed. In addition, every positive charge and every negative charge in the universe form a dipole, regardless of the separation distance between them. That dipole is also performing the gedanken experiment process. Every dipolar EM circuit contains innumerable such dipoles — e.g., across "open paths" between the various points in the circuit, as shown by Kron {192}. Kron {193} stated:

*"... the missing concept of "open-paths" (the dual of "closed-paths") was discovered, in which currents could be made to flow in branches that lie between any set of two nodes. (Previously - following Maxwell - engineers tied all of their open-paths to a single datum-point, the 'ground'). That discovery of open-paths established a second rectangular transformation matrix... which created 'lamellar' currents... " "A network with the simultaneous presence of both closed and open paths was the answer to the author's years-long search."*

By considering all dipoles in the universe, one has in fact finally defined Kron's open path. One has also defined the master mechanism responsible for the incredible EM energy density of the vacuum — the so-called "zero-point EM energy". Overall, every electrical circuit thus has innumerable energy flow broken 3-symmetries in it, with respect to exchange of EM energy flow between the time and 3-space domains. To sum all these broken 3-symmetries to an overall net 3-symmetry during the discharge of the free excitation energy of the circuit, obviously requires some specific macroscopic cohering function in the circuit. Moreover, one exists. Specifically, the closed current loop between the external circuit attached to the generator and the internal source dipole created between the terminals of the generator, is what enforces the circuit's net 3-symmetry and Lorentz symmetrical regauging. That is an arbitrary man-made condition, and not a law of nature, physics, or thermodynamics.

<sup>62</sup> Or to a charge with its clustering virtual charges of opposite sign, if we redo the experiment with a single "isolated" observable charge and consider it more exactly as a set of composite dipoles, each of which exhibits broken symmetry in the vacuum virtual particle flux.

By our gedanken experiment's demonstration and the existence of innumerable disequilibria between the active environment<sup>63</sup> and the system in an ordinary EM circuit, it follows that a Maxwellian circuit must be *capable* of exhibiting a coefficient of performance (COP) of  $COP > 1.0$ . It is a giant collection of open dissipative systems, far from equilibrium in the vacuum exchange.

That concept of course is contrary to the entire present mindset of electrical engineering and Maxwell-Heaviside-Lorentz classical electrodynamics. Those disciplines merely continue to accept the source charge as if it freely created from nothing all that energy in its associated fields and potentials reaching across the universe. Ironically, so long as the giant negentropy of the common dipole and its disequilibrium with its active environment (the local active vacuum and the local active curvatures of spacetime) are unaccounted, engineers and scientists will continue to produce the inane Lorenz/Lorentz-regauged power systems they produce today and have produced for more than a century. Also, they will continue — wittingly or unwittingly — to implicitly prescribe that every charge and dipole in the universe violates the conservation of energy law and is thus a *perpetuum mobile* of the grossest kind: a system which massively and continuously creates EM energy from nothing.

We now point out something deeper and very important. In modern physics, the *observed* positive charge is regarded as the time reversal of the *observed* negative charge. See Figure 3-2. If the negative charge is responsible for EM energy flow from the time-domain into 3-space, then *as observed* the positive charge must represent a time-reversed situation. We observe time reversal in the charge domain as a parity reversal and a charge reversal, but with the energy remaining positive. In other words, one imagines that one records a process on videotape, and then runs the video backwards to observe the "time-reversed" situation. When observed, both the sign of the positive charge and its direction of motion appear to us to be reversed from the negative case.

<sup>63</sup> In paragraph 3.10 and in Chapter 9 we will introduce — more deeply — the notion of the supersystem, consisting of three parts: (1) the system and its dynamics, (2) the active vacuum and its dynamics, and (3) the active spacetime curvatures and their dynamics. All three components of the supersystem interact with each other. In our gedanken experiment, the system (component 1) must receive the excess energy from the system's external environment, which consists of components 2 and 3 of the supersystem.

It follows that the positive charge as observed involves a flow of (positive) energy from 3-space back to the time domain. If we wish, before observation we can accept that "observed positive energy inflow" as an unobserved outward radiation of negative energy. Thus, a dipolarity involves a continuous flow of energy from the time domain into 3-space, and back from 3-space into the time domain (Figure 3-2). The energy flow circuit (circulation) is completed by a remaining energy flow across the dipolarity in the time-domain only, from the positive charge where the energy enters the time domain, to the negative charge where it exits again.<sup>64</sup>

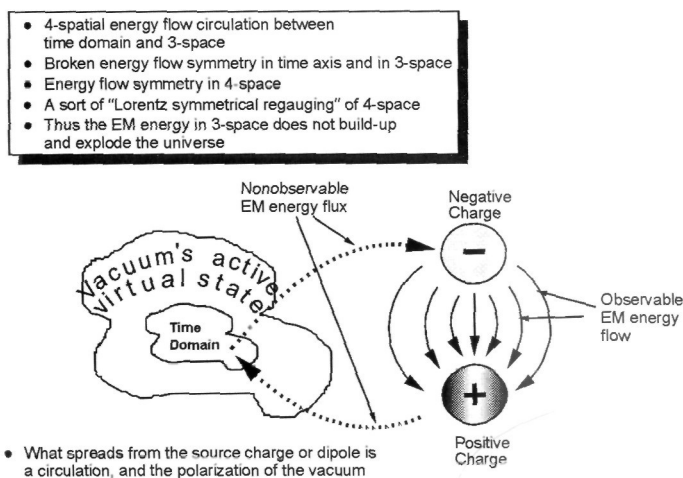

Figure 3-2 Circulation of energy flow in a dipole, between time domain and 3-space.

<sup>64</sup> Rigorously, we should speak of  $+qt$  and  $-qt$ . Charge  $q$  is an observable, and therefore an instant frozen snapshot. No observable exists continuously in time, but instead it recurs continually as the photon interactions — iteratively producing the  $d/dt$  (LLLT) = LLL observations — continue. The moment a charge  $q$  absorbs a photon, it changes to  $qt$  in form. The moment the charge-time  $qt$  emits a photon, it changes back to  $q$  in form. This incessant change of  $q \rightarrow qt \rightarrow q \rightarrow qt \rightarrow \dots$  is continual, at every level of the macroscopic charge, with its entire ensemble of photon interactions, including both virtual and observable photon interactions. As can be seen, the "charge as it persists" and "moves through time" has a rich dynamic substructure essentially ignored in present electrodynamics. It is, however, recognized by leading theoreticians and Nobelists.

However, even each of the clustering virtual charges and each of the differential charges of the observable charge, may be further broken into a central charge and clustering charges of opposite sign, in the modern view of the vacuum and its polarization. Hence, at any level — electron or positron — we actually have a dual and slightly separated bidirectional flow, at least in the observable equilibrium condition. The "positive energy" and positive flow of time is usually associated with "inert" matter with the electrons on the outside, so that the observer observes normal matter through the "forward time" situation mostly. Hence much of the accompanying backwards or time-reversed flow — from the positive charges in the nuclei, etc. — is "buried in the vacuum virtual state" in the Dirac sea and in Dirac sea hole flows.

Indeed, the vast hierarchy of nested structures and nested dynamics in charge as it exists in the vacuum, is recognized in physics, as is the fact that it involves infinite energy. E.g., quoting Nobelist Weinberg {194}:

*"[The total energy of the atom]... depends on the bare mass and bare charge of the electron, the mass and charge that appear in the equations of the theory before we start worrying about photon emissions and reabsorptions. But free electrons as well as electrons in atoms are always emitting and reabsorbing photons that affect the electron's mass and electric charge, and so the bare mass and charge are not the same as the measured electron mass and charge that are listed in tables of elementary particles. In fact, in order to account for the observed values (which of course are finite) of the mass and charge of the electron, the bare mass and charge must themselves be infinite. The total energy of the atom is thus the sum of two terms, both infinite: the bare energy that is infinite because it depends on the infinite bare mass and charge, and the energy shift... that is infinite because it receives contributions from virtual photons of unlimited energy."*

Here again we have met Kron's "open path" in a new and unrecognized form.



Hopefully we now are in a position to rigorously define charge — or try to — for the first time in physics.<sup>65</sup> **Charge** is the ongoing circulation of EM energy flow between the time and 3-space domains, as seen by the observer. **Negative charge** is the ongoing absorption of positive EM energy input from the time domain (from ict), transduction of the absorbed energy into positive 3-space EM energy, and re-emission of the EM energy in all directions in 3-space. **Positive charge** is the ongoing absorption of EM energy input from 3-space, transduction of the absorbed energy into the time domain, and re-emission of the EM energy in the time domain. Or contrary-wise, one may regard the positive charge as the ongoing absorption of *negative* EM energy input from the time domain, transduction of the absorbed negative energy into 3-space, and re-emission of the negative EM energy in all directions in 3-space. The negative charge then absorbs the negative EM energy impinging on it from 3-space, and transduces it into negative energy flowing back into the time domain.

Any *overall* curvature of spacetime, as seen by the observer, results in one of the two flows *predominating* as seen by the observer. Usually, at  $COP < 1.0$ , this Dirac sea hole current does not bother our circuit's operation, but remains confined to the local vacuum. It is often not bothersome or is minor for other than very high COP's. The reason is that, for such moderate and small COP's, most of the Dirac sea hole currents react either with (i) the seething local vacuum virtual particle cauldron, or (ii) the atoms in the material lattice to form lattice holes.

As the COP increases, the fraction of Dirac holes interacting with the lattice to form lattice holes increases. As the COP further increases greatly, a large fraction of the Dirac sea holes do not react with the local vacuum cauldron (they become stable forms in that cauldron) or the lattice, but flow into the input section of the system to react with and "eat" incoming electrons from the external power source.

If the inflow of electrons is insufficient to fill the arriving Dirac sea hole current at the input section, the hole current passes back into the feeder line and into the distant power source, eating electrons all the while. This

<sup>65</sup> This is still a first order, macroscopic definition. For a more comprehensive statement, one must spell out the hierarchy and dynamics of the virtual state, the participating mass of the charged particle and its generatrix, the operations and dynamics of the  $d/dt$  observation operator, etc. We have not yet succeeded in getting all that into a single reasonable but sufficiently short statement!

includes eating electrons in the distant power source, which simply "sees" that it must furnish additional current and voltage (power) toward the distant circuit or system.

In that operational COP region where strong interaction with the lattice occurs, the attachment of the lattice positron (lattice hole) to the mass of the atom or other ion, results in a very sluggish response of the overall ion with EM fields, compared to the response of an electron or a negative energy state electron hole (Dirac sea hole). Hence much of conventional electrical power circuit theory ignores the lattice holes and hole currents which no longer have negative energy because they have reacted and been "observed". Semiconductor designers, however, account for it and handle it in the semiconductor (in a given range of operation) primarily by the use of donor and acceptor materials.

At  $COP \gg 1.0$ , however, the Dirac sea hole current must be strongly taken into account because it produces substantial and novel new effects in the power system itself. This Dirac sea hole current "flows in reverse" with respect to the circuit — from output back to the input. In short, it flows *through the vacuum* from the output section of a unitary  $COP \gg 1.0$  system, back through the middle section of the system, and back into the input section where it "eats" incoming electrons from the external power supply. The power supply thus must furnish electrons to "kill (power the killing of) the Dirac sea hole current arriving in the input section", while still furnishing the necessary amount of additional electrons to power the circuit's losses and loads.

The hole current arriving back in the input section of the unit poses an additional "power system load". These holes must be filled with incoming electrons (which disappear into the Dirac sea hole in the vacuum without radiation, due to the concomitant relaxation or change of the local curvature of spacetime) before any incoming electrons are left to power the circuit in normal fashion. So the hole current appears as a highly undesired extra "load" formed in the input and "eating input power from the external power supply".

We further discuss this situation and how to deal with it, in Chapter 9.

**Finally**, we propose a formal modification of the concept of "EM energy flow through space" (perhaps the first since its formulation independently by Heaviside and Poynting). The EM energy flow connected with the charge is a circulation of EM energy flow between the time domain and 3-space and back, *as a result of dipolarity*. This 4-circulation flow occurs at every point in 3-space (at every point dipole in the 3-space vacuum).

The formation of an observable charge results in an immediate, continuing, spreading re-organization (polarization) of the polarization of the vacuum virtual particle flux itself. It is this *spreading polarization of the vacuum* — and its accompanying giant negentropy EM energy flow circulation in 4-space connected with the spreading dipolarity and the observable "source" charge — that moves outward in all directions at the speed of light in 3-space from the newly formed charged particle or group of them.

We also define charge itself as that *continuously spreading dipolarity in 3-space*<sup>66</sup> accompanied by the giant negentropy EM energy flow 4-circulation from the time domain to 3-space and back.

*The giant negentropy circulation in 4-space* — represented by the spreading vacuum point-polarization and hence broken 3-symmetry — is what (observably) moves out in all directions from the newly formed observable charge. Since we "observe" only the 3-space aspect, we "see" it as the spreading appearance of 3-space EM energy (the polarization change of the vacuum itself) moving in 3-space, because we "see" it as the iteratively observed frames of a motion picture. *As observed*, that is one way of expressing it. *As it actually exists and happens prior to observation?*<sup>67</sup> the so-called "flow of EM energy in space" is not that at all. It is the radial spread of the appearance of a giant 4-space negentropy EM energy flow circulation between the dipoles formed in the polarization of space. In that process, the special 4-symmetry between time and space is maintained but with broken 3-energy flow symmetry and broken time-energy flow symmetry with respect to the 3-space observer.

<sup>66</sup> I.e., the spreading partial restructuring and re-organization of the vacuum energy or energy flux.

<sup>67</sup> The sharp-eyed reader will note that we clearly distinguish between the operation of a "tree falling in the forest" without an observer to see it, and a "tree falling in a forest" as an observer sees it. Without observation, there is no observed tree, no observer, and no "observed falling". Yet there exists the "tree x time", the "observer x time", and the "falling x time" whether or not their observation occurs with its resulting  $d/dt$  differentiation operation. One set (the causal set) is 4-spatial, and the other set (the event set after observation) is 3-spatial. The cause is 4-spatial and unobserved, and the effect is 3-spatial and observed. They are not the same, though related by the  $d/dt$  observation operator and by the interaction of the 4-space cause with a previous 3-space frozen observation to change it to a new 3-space frozen observation. Note that one can and does have a cause without an effect in any legitimate theory of causality, but not an effect without a cause. The cause only assumes the potential for interaction and observation, whereas the effect assumes that the interaction has occurred, yielding the observation as the effect.

The 4-circulation (giant negentropy) of the EM energy flow "from" or "connected with" a charge, is intimately connected with the spin of the charged particle, since the charged particle spins in both the time domain and in 3-space, as discussed in paragraph 3.3 below. We believe the spin itself is the basic giant negentropy generator.<sup>68</sup> If that hypothesis is true, then giant negentropy, the circulation of EM energy between time-domain and 3-space and back, broken 3-symmetry and broken time-energy symmetry (as seen by the observer), the flow of EM energy through space (as observed), the nature of charge itself, and polarization of the quantum mechanical vacuum are all just different sides of the same coin.

Without amplification, we state that his giant negentropy outflow process has additional important ramifications in electrodynamics, general relativity, particle physics, and unified field theory. However, we leave further discussion of the subject for a future paper or book and for the advanced theorists.

### 3.2 Reinterpreting Whittaker's Decomposition of the Scalar Potential

As previously stated, we applied and re-interpreted Whittaker 1903 decomposition of the potential {85} between the ends of the dipole. The scalar potential is actually a harmonic set of bidirectional longitudinal EM wavepairs, where each wavepair consists of an outgoing EM longitudinal EM wave in real 3-space and an incoming EM longitudinal EM wave in the complex plane. Hence we have a new and novel EM energy flow symmetry in 4-space, where (as seen by the observer) the broken 3-symmetry of the dipole has removed the usual arbitrary imposition of an additional condition of 3-space energy flow symmetry as well. Simply making a dipole permissibly breaks the 3-space conservation of energy flow symmetry, and moves to 4-dimensional conservation of energy flow. Both EM energy conservation in 3-space and in the time domain are individually broken, but conservation of energy flow is now upheld between the time-domain and the 3-space domain. In blunt terms, we "consume a little time" to get any EM energy that exists in 3-space.

<sup>68</sup> We leave to a future sharp young graduate student the business of expressing the angular momentum (spin) of the charged particle as a result of giant negentropy in EM energy flow between the time domain and 3-space. It can probably be done by deeply considering the giant negentropy process for an "isolated" observable charge considered as also containing its clustering set of virtual charges of opposite sign.

The broken symmetry of a source dipole — or of a source charge considered with its clustering virtual charges of opposite sign as a set of dipoles — produces a continuing giant 3-negentropy, as seen by the observer. He only sees the steady 3-space outpouring of energy, and sees that it will continue as long as the dipole or charge remains intact.

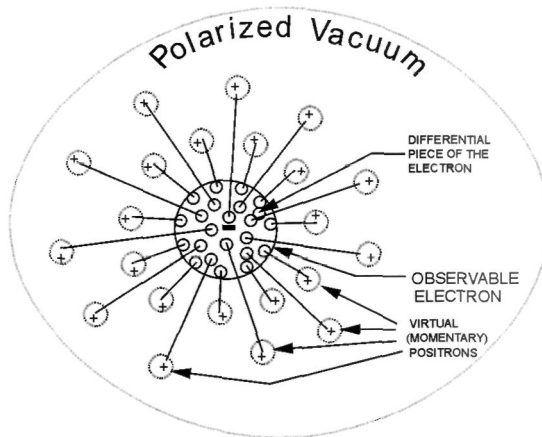

Figure 3-3 Observable electron charge as a set of composite dipoles.

To clarify the "isolated charge" as a set of composite dipoles, see Figure 3-3. There is no such thing as an *isolated* observable charge in 3-space; instead, the observable charge is surrounded by attracted virtual charges of opposite sign in the active vacuum. We take a differential piece of the observable charge and a momentary virtual charge of opposite sign, and call the two a "composite dipole". An observable charge is simply a set of composite dipoles connecting virtual and observable energies and energy flows.

Hence any source charge (classical sense) may be considered such a set of composite dipoles. So any source charge also multiply initiates the broken 3-symmetry and broken t-symmetry in EM energy flow (as interpreted by the observer), but conserves energy flow 4-symmetry between the time domain and the 3-space domain. In 4-space, there is an energy flow circulation from the time domain to 3-space and back to the time domain again.

This special circulation of energy is strikingly similar to, and may be an extension of, Heaviside's unpublished theory of combined electrodynamics and gravity, where he used closed circulation of EM energy as exhibiting

gravitational effects (in modern terms, producing spacetime curvature) {195, 172b.}. This approach or extensions of it may yet have a profound impact on physics, as commented upon by Laithwaite {196}. Certainly Heaviside considered his own energy flow theory. So it appears that he considered the excess energy flow — that "misses" the interaction with the circuit or assumed unit point charge and is not utilized — as producing gravity. That of course would be in perfect agreement with modern general relativity, since any change in the local energy density of vacuum is also a change in the local curvature of spacetime. We have called that Heaviside nondiverged and unaccounted EM energy flow by the label *dark positive energy*. See our further discussion of unaccounted (dark) positive energy in paragraph 3.8 below.

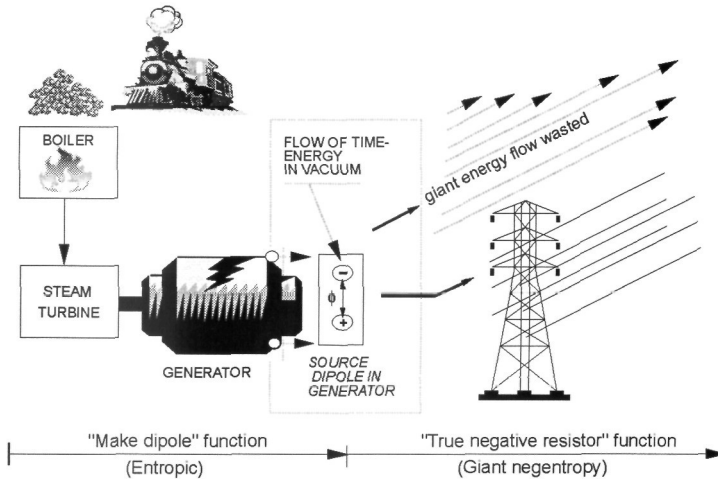

Figure 3-4 Dipole in generator powering circuits, taking energy from the time domain.

See Figure 3-4. This 4-symmetry is a far more fundamental energy flow symmetry than either 3-symmetry or t-symmetry. Both the "isolated charge" and the dipole are open systems far from equilibrium with their external active environment (the active vacuum and the active curvatures of spacetime). They are permitted to perform the five "magical" functions of disequilibrium thermodynamical systems. Such a system can: (i) self-order, (ii) self-oscillate or self-rotate, (iii) output more energy than the operator inputs, (iv) power itself and its loads (the "load" of a source dipole or source charge may be said to be comprised of the associated fields and potentials reaching across all space, and the continuous flow of

energy necessary to maintain those fields and potentials), and (v) exhibit negentropy.

The source charge and the source dipole exhibit all five functions. We often refer to these characteristics of a charge or dipole as its *giant negentropy* functions {197}.

It only takes a single white crow to prove that not all crows are black. Every charge and dipolarity in the universe is already a Maxwellian system far from thermodynamic equilibrium with its local active environment — the very class of Maxwellian systems that Lorenz/Lorentz symmetrical regauging of the Maxwell-Heaviside equations arbitrarily discards. That local environment consists of the local curvatures of spacetime and the local active vacuum. The system together with the two components of its active environment is called the *supersystem*. All three components of the supersystem continuously interact with each other and exchange energy. All is dynamic, continuously. Any appearance of a "static state" in the system is actually an equilibrium condition stabilized in the ongoing supersystem dynamics.

So one does not have to "prove" that Maxwellian systems exhibiting  $COP > 1.0$  (even  $COP = \infty$ ) are possible. Every charge and dipolarity in the universe is already just such a Maxwellian system, even though all such systems are erroneously discarded by Lorenz/Lorentz symmetrical regauging. Either one must accept asymmetry and  $COP > 1.0$  EM systems in electrodynamics, or one must purge from the theory all the charges and dipoles and all effects from them. That destroys all the charges, all the fields, and all the potentials.

That also destroys electrodynamics itself, as well as chemistry, particle physics, and most of modern science. The arch critic of overunity EM system research would do well to acquaint himself with some additional physics. Either that, or practice what he advocates, and give up all charges and dipoles and all effects from them — including in chemistry, particle physics, materials science, etc. When he holds on to the charges and dipoles while insisting on the impossibility of  $COP > 1.0$  Maxwellian systems, his cherished conventional EM theory eats itself by its own tail and becomes an oxymoron.

### 3.3 How the Dipole Charges Transduce Time Energy

We present a simplified analogy<sup>69</sup> that allows one to visualize how the dipole transduces the incoming time-like longitudinal EM energy flow into 3-space real EM energy flow for negative charge, or vice versa in the case of positive charge. With a little oversimplification, a charge may be said to spin 720° degrees in one complete rotation. For our purposes, it spins 360° in the imaginary plane (over in *ict*), and then spins 360° in the real plane (in 3-space). Thus the negative charge can absorb the incoming EM energy flow in the complex plane, transduce or "flip" the absorbed EM energy into 3-space to begin its 360 degrees in 3-space, and the excitation can decay during that 3-space spin part of the cycle. The only "variable" in *ict* is the *t*, so any energy flow has to be "by means of the variation of the *t*-variable". We already argued in a previous chapter that time can be treated as highly compressed spatial energy, having the same energy density as mass. So absorbing a very tiny amount of time-energy and transducing (decompressing) it into spatial energy produces enormous spatial energy (*t* multiplied by the factor  $c^2$ ).

The negative charge absorbs a *little bit* of positive time energy, transduces it into a much larger amount of 3-space excitation energy, and re-emits it in 3-space as an observable, real flow of EM energy radially outward in all directions. The positive charge receives the large amount of 3-spatial EM energy and absorbs it, transduces it back into time-energy (highly compressed energy) and re-emits it in the time domain as a little bit of highly compressed time energy.

Conversely, we may consider that the positive charge absorbs a little bit of negative time energy, transduces it into a much larger amount of negative 3-space excitation energy, and re-emits this negative 3-space energy in all directions in 3-space. That consideration is important in the cold fusion phenomenology, and in fact accounts for the formation of little fleeting "time-reversal zones" in the electrolyte solution where the law of attraction and repulsion of charged particles is momentarily reversed. The omission of the giant negentropy mechanism and the negative energy mechanism from particle physics reaction theory is why there do not exist such nuclear transmutation actions at low spatial energy (but high time energy) in

<sup>69</sup> For simplification, the analogy treats "spin" of the charged particle as if it really were something like that of a spinning top, at least in its 3-spatial component. However, in physics the entity **spin** is not confined to a flat plane or even to 3-space. **Consequently**, we caution that the analogy is primarily a mnemonic aid.



conventional particle physics. All such permissible reactions have been arbitrarily omitted from the discipline.

For the positron (or any positive charge), we assume that the process is reversed: 3-space energy is continuously absorbed (from the active vacuum exchange) by the positive charge during its  $360^\circ$  spin in 3-space. This 3-space excitation energy is then flipped into the time domain as time-charge or time-energy, as the charge starts its second  $360^\circ$  spin in the time domain. During that latter part of its  $720^\circ$  spin cycle, the spinning charge re-emits the time-charge energy (time-excitation) as a flow of a little bit of very dense EM energy in the time domain.

The effects of these mechanisms in systems of charges in motion are met with as time dilation effects, spacetime curvature effects, frame rotation effects, etc. in relativity theory.

A charge that has received excess EM energy from the time domain is said to be *time-charged* or *time-excited*. Since time-charge or time-energy is  $c^2$  denser than spatial energy, a tiny amount of time-energy excitation or time-charge may be re-emitted as substantial spatial energy over a period of time. In short, the decay of time charging or time-excitation of charged particles can occur slowly and over time. The decay is marked by the presence of longitudinal EM wave radiation, by mysterious ionization phenomena appearing in some Geiger counters depending on their individual time-histories (individual initial time-charging condition), and by excess energy appearing in electrolytes and emitted as heat where such decay of time-charge is occurring.

Usually in ordinary circuits and EM systems the time-charge and time-charge-decay effects are minimal, being offset by their opposites in close adherence to equilibrium. However, when this is not the case and time charging does appreciably occur, then novel phenomena result in those circuits and systems. Such effects have occurred for some time in instruments associated with rigorous electrolyte experiments at U.S. Naval research facilities at China Lake {198}, but the researchers have not recognized the cause. We have pointed out the time-charge and time-decay solution to those novel phenomena, and explained why apparently "identical" instruments need not respond to the stimuli in the same manner {199}. Along the way, we also explained several of the low spatial energy (thus high time-energy) transmutations, including giving the typical reactions producing the excess deuterium, tritium, and alpha particles. We also explain those new nuclear reactions at low spatial energy (but high time-energy) in Chapter 10.

As we stated in Chapter 1, paragraph 1.1.3: In such electrolyte experiments where the palladium electrodes load with concentrations of positive charges on hydrogen ions of one form or another, then in the adjacent solution there can arise fleeting **time-reversal zones**. Such a zone is simply a very tiny volume of fluid in which antiphotons temporarily comprise the majority of the ongoing photon interactions with the local ions in solution in that zone. The result is that the normal (time-forward) law of attraction of unlike charges and repulsion of like charges is reversed; *in the TRZ, like charges attract and unlike charges repel*. This allows two positive ions such as H<sup>+</sup> to be drawn together so tightly that each enters the (reduced) strong force region of the other, forming a quasi-nucleus. When the other ions move to eliminate the TRZ, during the decay of the TRZ the strong force increases more rapidly than the EM force. Hence, the preferred method of decay of the now-excited quasi-nucleus is by quark flipping to allow the quasi-nucleus to become a new nucleus. This nuclear transformation interaction allows the production of the excess deuterium, tritium, and alpha particles.

### 3.4 Reordering of the Local Vacuum: Giant Negentropy

A giant negentropic reordering of a fraction of the surrounding vacuum's energy is initiated when a dipole or charge is formed. This reordering is deterministic, and is the 4-flow energetic structure shown by Whittaker {85}, slightly reinterpreted, with perfect coordination of the converging EM energy inflow in the complex plane with the outflowing converted real EM energy in 3-space. Hence this negentropic reordering introduces "hidden order" into the vacuum's otherwise disordered energy. This reordering of a fraction of the vacuum's disordered energy also changes the Gibbs statistics assumed in quantum mechanics, replacing it with an "already chaotic" statistics containing hidden order. We propose this as a possible contribution toward resolving the presently unsolved problem of the missing chaos in quantum mechanics {200}.

### 3.5 Some Implications of Giant Negentropy

Giant negentropy has many envisioned impacts upon physics, such as:

- (a) Allows development and use of negentropic EM circuits (COP>1.0 systems) rather than entropic circuits. Once a broken 3-symmetry with stable 4-symmetry is established (as by forming a dipole), it continues indefinitely unless deliberately destroyed.

- (b) Allows direct negentropic reordering of a practical and usable fraction of the vacuum's energy at will, at any point in the universe, easily and cheaply.
- (c) Provides for electrodynamic engineering of the vacuum energy and of spacetime curvatures clustered in specific templates (the concept of vacuum engines or spacetime curvature engines). This has significant medical applications {387c}.
- (d) Utilizes time as energy (per our previous discussion) and thus allows use of the Whittaker phase conjugate half of the biwave set as an EM energy flow within the flow of time. Observably this translates to the continuous receipt of free time-energy by the formed broken 3-symmetry (e.g., the charge or dipole). Accordingly, the charge or dipole continuously pours out real observable EM energy in 3-space, without any observable EM energy input (time is not observable, and neither is the time-polarized photon alone).
- (e) Allows "burning a little time for fuel", so to speak, in order to transduce it into a very large spatial energy flow, due to the enormous compression of 3-spatial energy represented by time-energy by a factor of  $c^2$ .

So from the giant 3-negentropy discovery, we have arrived at some intriguing findings:

- (a) As is well known in particle physics, the opposite charges of a dipole constitute a broken 3-space symmetry in the violent flux exchange between the active vacuum and the dipole.
- (b) This dipole's broken 3-space symmetry in EM energy flow, provides a *relaxation* to a more fundamental EM energy flow symmetry between the time domain and 3-space, and therefore in 4-space.
- (c) There is no law of nature or physics that requires 3-symmetry of EM energy flow as an additional condition applied to 4-symmetry of EM energy flow. Instead, 4-symmetry energy flow is more basic, by the hierarchy rule.<sup>70</sup>

<sup>70</sup> Quoting Steven Weinberg: " ..there is a hierarchy of symmetries; whatever symmetry unites the gravitational and strong nuclear forces with the electroweak

- (d) The dipole is a practical and very simple means of "breaking" the additional 3-flow symmetry condition in EM energy flow our systems have previously exhibited, and relaxing to the fundamental 4-flow symmetry *without* 3-flow symmetry.
- (e) So long as the dipole statically exists (e.g., imagine an electret suddenly formed, or a charged capacitor with no leakage), real usable EM energy circulation between time and 3-space, at each point in 3-space, will continuously move out from the dipole at light speed in all directions. In the view of the observer, at the same time, reactive EM power (actually, time-energy) will continuously flow into the dipole from the time-domain (the complex plane), and be transduced into real EM power output radially outward in 3-space from the dipole.
- (f) Observably, a dipole or dipolarity and its scalar potential thus comprise a *true negative resistor* system of the most fundamental kind. The dipole continually receives EM energy in unusable form (reactive power, which cannot perform real work), converts it to usable form (real power, which can perform real work), and outputs it as usable, real EM energy flow (real power) in 3-space. Further, it spreads this "transformation of time-energy into 3-space energy at every dipole point" outward in 3-space in all directions.
- (g) So at its formation the dipole initiates a continuing *giant negentropy* — a progressive reordering of a substantial and usable portion of the vacuum energy {201} that begins with dipole formation and continues. Further, this reordering of vacuum energy flow at every point in space continuously spreads in all directions from the initiation point, at the speed of light. Dipoles in original atoms formed shortly after the beginning of the universe, have been pouring out real EM energy for some 14 to 15 billion years or so (i.e., in the prevailing view; the age of the universe and whether it is expanding are still controversial {754}), and have reordered a fraction of the vacuum's energy, where the magnitude of the re-ordering varies inversely as a function the

*forces is broken roughly a hundred million million times more strongly than the symmetry that unifies the weak and electromagnetic interactions. The puzzle of explaining this enormous difference in fundamental energies is therefore known in elementary particle physics today as the hierarchy problem.*" [Weinberg, *Dreams of a Final Theory*, Vintage Books, Random House, 1993, p. 205],

radial distance from the dipole.<sup>71</sup> This is in fact the solution to the long-vexing problem of the source charge and its associated fields and potentials and their energy, reaching across the universe. The charge together with its associated clustering virtual charges is a set of composite dipoles, hence a multiple *broken 3-symmetry* energy flow system.

- (h) If the dipole is destroyed, the ordering of the vacuum energy ceases, leaving a "separated chunk" of reordered vacuum energy dynamics that continues to expand at the speed of light in all directions, steadily reducing in local intensity as it expands.
- (i) At any very small volume in space, from the dipole dynamics of the universe it follows that a great conglomerate of reordered vacuum flows and fluxes — some continuous, some chopped — is continually passing through that volume. Further, the situation is totally nonlinear, so that direct wave-to-wave interactions occur continuously amongst these energy flows and waves. We hypothesize that this is the actual physical mechanism constituting Puthoff's cosmological feedback mechanism {202}.
- (j) Further, in 1904 Whittaker {203} showed that any EM field or wave pattern can be decomposed into two scalar potential functions. This initiated what is called *superpotential theory*. Each of the two potentials for those functions, of course, decomposes into the same kind of harmonic longitudinal EM wavepairs as shown in Whittaker 1903, plus superposed dynamics. In other words, the interference of scalar {204} potentials — each of which is actually a set of longitudinal EM waves, and not a scalar entity {205} at all, but a *multivectorial* entity — produces EM fields and waves and their dynamics. Hence we hypothesize that the Whittaker interference of the propagating reordered EM energy entities, continuously occurring at any point in space, generates the zero-point EM field energy fluctuations of the vacuum itself. Indeed, an AIAS group paper by Evans *et al.* {206} has already shown that just such "scalar interferometry" produces transverse EM fields and waves in the vacuum at a distance.

<sup>71</sup> The field energy density in the fields produced by the source charge varies inversely as the square of the radial distance. The potential energy density in the potentials produced by it will vary inversely as the distance.

Since energy can neither be created nor destroyed, there really are no true *energy sources* in nature in the sense that they *create* energy and pour it out {207}. Instead, what we call "energy sources" merely convert the energy already there in one form, into another form. All energy sources are no different from a solar cell in the sun, or a windmill in the wind, at least in principle. They are actually energy transducers rather than energy sources. This corresponds well with the conservation of energy law wherein not a single joule of energy can be created or destroyed. Instead, the form of that joule of energy can be continually changed. Every joule of energy present in the universe after its formation is still present, and is still doing joule after joule of work in iterative interactions with transducers that change its form.

*A priori*, we can measure no real 3-space input of EM energy to the unchanging charge but we can measure real 3-space EM energy pouring from it. Energy must be input to it from the active vacuum in a *nonobservable* form, and converted by it into an *observable* form that is re-emitted, usable, and produces what we call the "fields and potentials" and their energy, associated with that "source charge". As is common usage, we will continue to use the term "source charge" or "source dipole", but with the understanding that we refer to a special kind of *energy transducer*.

When we "make entropy", we must do work. Even so, doing work is not really entropic unless we also lose control of the energy<sup>72</sup> — whose form was merely changed by doing the work — and thence lose any *further* ability to use that energy (change its form, or transduce it) to do useful work. And when we observe entropy, we also do work in the observing. Some of the erroneous notions about entropy desperately need correcting. E.g., quoting Weinberg {208} for a lay definition of entropy:

*"..a certain quantity called entropy: To define entropy, imagine that some of the system's temperature is very slowly raised from absolute zero. The increase in entropy of the system as it receives each small new amount of heat energy is equal to that*

<sup>72</sup> An interesting point is that energy is energy and remains energy. "Disordered" ultimately means "unusable" or "inconvenient" and nothing else. Disordered energy is still energy, and if we do not lose it from the system we can in fact have the **system** automatically reorder it, e.g. by use of simple retroreflection. The entire concept of entropy must be rigorously interpreted in terms of "energy whose reuse is lost", at least by the processes being performed by the system considered. In our view, "entropy" itself is just additional usually "lost" energy to be recovered.

*energy divided by the absolute temperature at which the heat is supplied."*

*"...entropy, which always increases with time in any closed system..."*

However, we point out that apparently there exists no completely closed system in the entire universe. In the notion of entropy and the escape of the energy from their "closed" system, thermodynamicists themselves ubiquitously negate the latter premise that entropy in a completely closed system always increases with time. That simply does not follow. The real situation is as follows: (i) Entropy in a half-open system with no allowed external input of energy, but with allowed escape of energy, does decrease with time if the energy of the system decreases with time by escaping.<sup>73</sup> Hence the cooling of "hot" water with time, if and only if the excess energy in the system can have a net escape to the (cooler) environment as time passes, (ii) Energy in a completely closed system (closed to both energy and mass), with no input and no output of energy at all, simply remains constant because it is not dissipated; simply apply the conservation of energy law. It may rearrange within, and the subcomponent energies may disorganize with respect to range, but the total energy remains. Entropy actually only deals with the loss of ability to utilize the energy. To wit, the assumed (and apparently true, so far as we can tell) conservation of energy in the present universe is an example. A closed system is in this sense a special case of a system in equilibrium with its active environment.<sup>74</sup> I.e., any "closed system" is such a special case.

<sup>73</sup> In case the reader has not thought of it, until the energy "escapes" it is not dissipating or dissipated from the dissipating "object". A "hot" object is energetically excited but not hot; the *energy dissipated* from it (including from every component within it) is scattering, and hence disruptive and "hot" in its interaction with a test instrument (or one's finger). The thermometer (or any other instrument) is external to the rest of the system (even if imbedded in it). Hence merely to "measure the temperature" is actually to pass energy out of the system into the thermometer (or other instrument), so that the thermometer measures the heat of the dissipating energy that has just escaped from the system. For these and similar reasons, Romer — former editor of *A. J. Phys.* — pointed out that "heat" should not even be used as a noun {84}.

<sup>74</sup> The concept of energy always requires that one can write "energy of...(X)" and fill in the (X). We usually write the phrase "of...(X)" as "X energy". Thus we write the phrase "energy of heat" as "heat energy," the "energy of the vacuum" as "vacuum energy", and the "energy of the EM entities" as "EM energy". At least in its usage, energy always requires a medium or entity "having" or "exhibiting" the energy. As Feynman pointed out, we really do not know what "energy" per se is.

(iii) In a system closed with respect to output (escape) of energy, but with the system opened only to allow external input of energy, the system energy will increase, simply by the conservation of energy law. That system's entropy will decrease and its negentropy will increase. (Its mass will also increase, and so it violates the thermodynamic misdefinitions of closed system; see Appendix A). It is well known that the entropy of an open system far from equilibrium cannot even be computed! (iv) Energy in an open system where input of energy and escape of energy both occur, may either increase, decrease, or remain constant, depending upon whether the input rate exceeds the output rate, or vice versa, or the energy input and output rate are equal. Therefore such a system can exhibit overall entropy, overall negentropy, or overall equilibrium, (v) Net energy scattering rate (rate of energy escaping the system in disordering fashion) from a hot system determines the observed temperature of that system at the time of observation. The system itself is cold, prior to escape of the energy. The "heat" is due to the interaction of the escaping energy with an external object, in its disordering fashion. Inside the system prior to escape, the energy is ordered hence cold.

A system in equilibrium in its exchange with its active external environment is in a state of maximum entropy *for that specific rate of energy exchange with its environment*. As we will point out in Chapter 9, by deliberately balancing the *system-and-vacuum* exchange with the *system-and-curved spacetime* exchange, so that the two exchanges are equal and opposite at a desired rate of exchange, one may establish (at least in theory) system equilibrium at whatever specific rate of energy exchange is desired.<sup>75, 76</sup> In this fashion, e.g., an "impossible" molecule normally intensely unstable and decaying in a nanosecond or less, can in fact be stabilized once an appropriate balance between the two opposing energy exchanges with the system is achieved at the required specific rate of energy exchange. This is actually a new Lorentz symmetrical regauging

<sup>75</sup> This is necessary, e.g., to close-loop a COP>1.0 EM unitary system taking its input energy from the vacuum, as we shall see in Chapter 6.

<sup>76</sup> The Fogal superluminal transmission system in fact uses a conventional signal input to change this "symmetrical regauging" condition in consonance with the amplitude of the input signal. Thus suddenly Lorentz symmetrical regauging becomes a way to transform a conventional signal into a signal consisting of changes in the stress energy potential of the vacuum. That constitutes a longitudinal EM wave, and so it is not limited by the speed of light. To use this process, a Fogal semiconductor must be used as the modulator in the "transmitter", and another must be used as the demodulator in the "receiver".



condition; change of symmetrical regauging is very useful in this fashion. In this way, a great new chemistry with reactions presently deemed impossible is in the offing, and it is already being developed by at least one U.S. company. We do not name the company, under our tacit agreement with the scientists doing the work.

To operate conventional entropic systems,<sup>77</sup> first we must input energy to the inert system to force it out of equilibrium and back into excitation (back into an asymmetrically regauged system, violating the Lorentz condition) so that it has some excess energy (and negentropy). Then we allow the decay of the excited system's excess energy to pass through a load and be dissipated from it, doing work for us by powering the load. Conventional systems usually do not recapture the "escaping dissipated energy" but just waste it. *"Dissipating" energy is merely allowing it to escape from the system and from further system control.* Then we brutally force more excitation energy into the system, opening it and breaking its equilibrium to do so. Again we dissipate the system's excitation energy in the load to produce some more work, usually wasting an appreciable fraction of the excitation energy.

In EM systems, it is a little more complex. We continually "switch on" a negentropic flow of EM energy from the vacuum by making a source dipole. In the circuit, we collect a small part of the resulting huge energy flow in space surrounding the circuit conductors. Then we use half the collected energy to destroy the dipole source of the energy flow, while less than half of the collected energy is dissipated in the load (the rest of that second half is dissipated in the external circuit's losses). Hence we must continually restore the source dipole and pay more to do it than we get out in the load as useful work. We make a perfectly good negentropic system, and then forcibly destroy its negentropic ability faster than we power the load and get any use out of it. That's a terrible way to make and use power systems, but it is what has been done for more than a century.

So with our present entropic EM systems (actually our *self-killing negentropic* EM systems) we continually wrestle nature fiercely to the mat, so to speak, by brute force, repeatedly, to bind her into 3-space EM energy

<sup>77</sup> By "entropic system" we mean a system whose excitation energy decays and is dissipated from the system or at least from its further control, so that the entropy (lost or unusable energy) of the system continually increases until equilibrium (total decay of the excitation energy) is achieved. As can be seen, this also can be used to define entropy and increase in entropy. What is usually unappreciated is that *equilibrium is actually a counterbalance between ongoing entropy and negentropy.*

conservation. All the while, nature protests our continual entropic brutality by providing the Newtonian third law reaction force<sup>78</sup> back upon our causative wrestler performing the "forcing". To do entropic engineering, we have to continually input 3-space energy to the wrestling mechanism or engine, losing a bit of the input energy in the inefficiencies, and fighting the "back emf", "back mmf", or Newtonian third law reaction that is nature's cry of protest all the while. Those are nature's penalties for imposing a monstrous 3-space EM energy flow symmetry<sup>79</sup> upon her as an *additional, highly undesired, and highly unnatural condition* added upon her beloved special 4-symmetry energy circulation between the time domain and 3-space.

In short, because we so love entropic engineering and 3-space EM energy flow symmetry, we have to provide the continual input energy to our entropic processes by burning fuel, damming rivers, erecting windmills, building waterwheels, erecting solar cell arrays, building and charging chemical batteries, etc. In the process, we destroy and pollute the biosphere on a giant scale as we rip down forests, strip-mine and drill the earth, pile up thousands of tons of radioactive nuclear wastes —that will be hot for thousands of years — from our power plants and related facilities, and spew streams of pollutants into the atmosphere, the rivers, the oceans, etc. We do all that biosphere destruction because we inexplicably insist upon placing cruel chains on nature by brutally enforcing 3-space energy flow symmetry upon her. In the process, we adamantly require adherence to classical equilibrium thermodynamics (as given a somewhat altered explanation above, and also in Appendix A).

We do not have to do it that way. In avoiding solving the source charge problem for so long (more than a century), we have been extremely

<sup>78</sup> Note that Newton's third law reaction is implicit in the special negentropic energy flow circulation of the dipole, or of the charge considered as a set of composite dipoles. The same energy that moves into 3-space from the time domain, then returns from 3-space to the time domain, at every point in the 4-circulation. If we consider the positive charge as a "source" of negative energy, then there is a concomitant circulation of negative energy from the time domain to a point in 3-space, and back to the time domain.

<sup>79</sup> The 3-space symmetry of energy flow equilibrium is actually between the energy we input (from its external environment) to the system, and the energy that escapes from the system back into its external environment, either in its losses or in its loads. As we stated, equilibrium condition is a balance between ongoing entropic and negentropic operations.

backward in our thinking and in our consequent development of entropic engineering technology.

For our dullness, we have had to pay and pay continuously for insisting on doing such atrocious entropic work and forcing nature to do it that way. In so doing, we "tie nature's feet" with that added arbitrary 3-symmetry in energy flow. We ourselves prohibit nature from performing the giant negentropy she so dearly loves and much prefers. We also arbitrarily and *meanly* discard the bountiful electromagnetic energy flow that nature loves to furnish us so freely by her vast preference for giant negentropy. We *meanly* discard nature's bountiful giant negentropy banquet free for the taking, by our vast thirst for giant entropy and doing violence to nature. Because we act like brutes instead of scientists, we destroy nature in spite of nature's continuing attempt to give us all the EM energy we wish, freely except for a little switching cost.

A far better way is to cooperate with nature and "let nature make her beloved copious negentropy" as she yearns to. To do that, we now can see the startlingly simple mechanism. We simply make a little dipole, *once*, entropically. So we have to pay for *making* the dipole, *once*, and we have to do just a little gentle violence to nature, *once*. Then we need do no more violence, if we just leave the dipole intact and do not destroy it. In short, we do have to tap nature gently on the shoulder. We do not have to brutally knock nature down to the mat, repeatedly.

When we make the dipole, we make a little bit of "broken 3-symmetry" in the universe's energy flow. Voila! Nature sings for joy at finally having her feet freed from the shackles of the horrid 3-symmetry energy flow. In great glee, she instantly relaxes into her dearly preferred giant negentropy and 4-symmetry. She instantly sets to re-ordering a substantial and usable

<sup>80</sup> E.g., so far as I am aware, there have been no funded research programs to discover how to deviate and collect some of the freely flowing energy from a permanent magnet or an electric dipole. Instead, electrodynamics has smugly continued to call it "statics" as if there were no dynamics, and ignored the giant negentropy circulation that is "seen" as the steadily outflowing field energy in 3-space, and erroneously called the "static field". There is no such thing as "statics" in the entire observed universe *a priori*; the very process of observation itself is dynamic. What we see as "static" is continual recurrence of a given condition or state or magnitude, as beautifully pointed out by Van Flandern {628}. One might even say that, not only is nature energetic, nature *is* energy, constantly changing and in motion in innumerable ways at once! One might even define "energy" as the process by which nature both acts and observes its actions, in every form and structure and possibility.

portion of the vacuum energy of the universe, in all directions at the speed of light, spreading her preferred giant negentropy EM 4-energy circulation flow from the dipole toward the ends of the universe at the speed of light. As long as we do not destroy the dipole (the broken 3-symmetry) that gently breaks the 3-symmetry shackles, nature's feet remain freed from brutal 3-space symmetry in EM energy flow. In that case, she delightedly continues to reorganize a portion of the vacuum energy, with the reordering spreading radially outward at the speed of light. Simply making a common dipole or charge<sup>81</sup> sets nature to going about reordering an ever-increasing fraction of the entire vacuum energy of the universe, and continuing indefinitely.

Simultaneously with freeing her from enforced 3-space EM energy flow symmetry, in great gratitude nature pours out an immense real EM energy 3-flow from that little dipole or charge. She will continue to pour it out forever for us, if we do not destroy the dipole or charge.

Instead of the present universal entropic engineering, the smart thing to do is make just a little bit of entropy wisely, using the work we get to break 3-space energy flow symmetry (basically, to make a dipole). *Then leave that mother of all negative resistors and free energy flow generators alone and forever unchanged!* Concentrate on intercepting, extracting, and using the free 3-space energy copiously flowing forth from the giant negentropy, without destroying the dipole that is freely providing it.

### 3.6 How Circuits Are Powered

Let us now look at the great magnitude of the energy flow that nature gives us from that dipole. We have to get into the subject a bit, because EM energy flow theory has been rather thoroughly confused for more than a century.

**First**, batteries and generators *do not* use their available internal energy — the shaft energy we input to the generator, or chemical energy available in the battery — to power the external circuit. Instead, each uses its available internal energy {209} to perform work on its own internal charges, forcibly separating the charges to form the *source dipole*.

See again Figure 3-4. *All the hydrocarbons ever burned, all the nuclear fuel rods ever consumed, and all the dams ever built, added not one single watt directly to the power line.* All the energy from those activities was

<sup>81</sup> As we previously explained, a charge is just a set of composite dipoles.

input to the generator shaft after normal losses en route, to provide internal magnetic energy available to the generator. In turn, the generator used that available internal magnetic energy only to do internal work on its own internal charges to force them apart, forming the source dipole connected to the terminals. Generators are energy transducers only; they do not directly power their own external circuits.

Batteries and generators expend their internal energy available to them, to make the source dipole, and for no other purpose! None of their internal energy is used to power their external circuit. It never has been, and it never will be.

*Once the source dipole is formed*, it does all the hypothesized 4-functions we pointed out previously. It induces the spreading giant negentropic reordering of the vacuum energy, extracts (transduces) EM energy from the continuously reordering vacuum, and pours out from the terminals of the generator (or battery) a vast 3-flow (as observed) of EM field energy along the external circuit. As indicated by Kraus's illustration of the Poynting component {210}, this giant EM energy flow fills all space surrounding the circuit, out to an infinite lateral radius.<sup>82</sup> The energy flow is generally parallel to the conductors of the circuit. Only a tiny component of this flow — due to the surface charges of the conductors and the little boundary layer of energy flow that slides along the surface of the conductors — strikes the surface charges and gets diverged into the conductors (by the lateral withdrawal of the surface charges — with the "stub" or "base" of their field energies — laterally into the conductors. The electrons move mostly laterally, withdrawing from one side of the conductor surface to the opposite. Only the tiny component of its field vector integrated over that small distance is withdrawn into the conductors to power the electrons. This small amount of "withdrawn" energy is the diverged Poynting component, "collected" by the circuit. It also is the small component then used (dissipated) to power the Drude electrons and the circuit.<sup>83</sup> All the rest of that vast EM energy flow in the surrounding

<sup>82</sup> We accent that Kraus, along with other authors, only shows the 3-space *Poynting component* of that flow; i.e., he shows the very small amount of that external 3-space energy flow that is diverged into the circuit to potentialize the Drude electrons and power the circuit. Kraus *does not* show the remaining Heaviside component that is not diverged.

<sup>83</sup> As shown by Kraus, some of the energy flow at the various radial distances from the wire is withdrawn, as the surface electrons and the "stubs" of their near fields precess laterally into the depths of the wire when potentialized. Jackson, *Classical Electrodynamics*, Second Edition, Wiley, 1975, p. 223 also points out the nonlocal

space, that pours forth from the terminals, just misses the circuit entirely. It roars on off into space and is wasted.<sup>84</sup>

The diverged, utilized, and accounted energy flow component — the *Poynting component* — is only a tiny, tiny fraction of the entire giant EM energy flow produced by the source dipole for every circuit.

### 3.7 The Heaviside Component vs. the Poynting Component

Unless Heaviside and Lorentz did rigorous calculations in a work we have not yet uncovered, we could not find any development of the functions and equations required for computing the numerical ratio of the unaccounted Heaviside "dark energy flow" (*nondiverged* energy flow component that misses the circuit), to the tiny Poynting energy component that strikes the surface charges of the conductors {211} and is diverged into the wires to power the circuit when the surface charges precess laterally into the wire.

Consequently, we performed a very crude "special case" estimation {212} — a back-of-the-envelope type, with highly simplifying assumptions — for a very simple circuit in which one resistor is powered by a DC source. Our crude estimate showed that about  $10^{13}$  times as much EM energy flow *misses* the circuit, is *not diverged*, and is *wasted* — as *strikes* the circuit, gets collected, and then is dissipated in the circuit to power the load and losses. Until electrical physicists re-examine the energy flow theory and

involvement of the transverse current. Quoting: "...the transverse current... extends over all space, even if  $J$  is localized." One notes that present electrical power systems concentrate exclusively on the  $J$  current, making no attempt to collect and utilize the recognized but rather ignored transverse current.

<sup>84</sup>Note, however, that this Heaviside energy flow component differs from  $E \times H$ . The Heaviside component is totally *nondiverged* (being actually in curl or swirl form), and since  $E$  and  $H$  are both *diverged* energy components assumed around an **Interacting** unit point static charge, there is neither  $E$  nor  $H$  in the electrical engineering sense prior to interaction with charge. So the energy flow in both the Poynting and Heaviside components is in a force-field-free form until intercepted by and interacted with charge. Poynting's component, e.g., assumes only that energy **component** that does interact with charge and get withdrawn into the circuit. **Heaviside's** component assumes only that energy component that does not interact with charge and does not get withdrawn into the circuit.

again recover the Heaviside unaccounted component in it, that brute force estimate will have to suffice as at least an illustrative example.<sup>85</sup>

What does that  $10^{13}$  ratio mean? For a little 1 watt generator of that DC type with that specific size conductors and that specific resistor, the Heaviside unaccounted energy flow component was about *10 trillion watts*, occupying all space surrounding the wire,<sup>86</sup> if all of it could be intercepted, collected, and used to power loads {213}. But the little circuit was only intercepting and collecting — and using to power loads — about  $10^{-13}$  of the available energy flow surrounding the circuit, *if all* of it could have been intercepted, collected, and used to power loads.<sup>87</sup>

We have never had, and we do not now have, an *EM energy* shortage or problem. We never will have one, due to nature's bounty in providing us with the giant negentropy of the common dipole and of the charge considered as a composite dipole. Instead, we have the two problems that

- (i) only a tiny, tiny component of the available 3-energy flow extracted from the vacuum (decompressed from time-energy) by

<sup>85</sup> We would very much welcome a much more accurate functional expose by a capable higher group symmetry electrodynamicist!

<sup>86</sup> We also point out that none of this nondiverged energy flow component is accounted in conventional electrodynamics and electrical engineering (the closest it comes is Jackson's mention of the transverse current over all space), and neither has it been accounted or even investigated by biophysicists seeking to determine the effects of EM radiation and fields upon biological systems. We strongly suspect (and have done a little work on the problem) that these "force-free fields" and neglected excess "strange energy" flows do have interactions throughout the highly nonlinear cells of the body, and can indeed have profound long term effects on long-exposed biological systems. We particularly stress the potential for time-charging and subsequent *combined scalar and longitudinal photon pair* decay of time-charge excitation in the body. Several major areas of electrodynamics — such as the transverse current effects, Heaviside component effects, and internal Whittaker structuring (engines) effects of EM radiation — have not been investigated by the scientific community.

<sup>87</sup> We accent that time-energy may be regarded as spatial EM energy compressed by the factor  $c^2$ . Hence one second =  $9 \times 10^{16}$  joules of EM spatial energy, if decompressed by time-energy interaction with charge. The crude estimate for one circuit of  $10^{13}$  times as much energy being wasted in the Heaviside energy flow component as is caught and used in the Poynting component, is thus quite reasonable when one recognizes that *all* the EM energy flow appearing in the circuit or outside it actually comes from the time domain, hence constitutes *decompressed time-energy*.

the source dipole and poured out of the terminals of the power source, is caught and used by the circuit, and

- (ii) in the closed current loop circuit, half of that small spatial EM energy component that is intercepted and caught, is used by the circuit only to destroy the source dipole and cut off the free flow of EM energy from the vacuum faster than it powers the load.

We have previously discussed this further in several papers {214}.

One must occasionally keep one's sense of humor. The real problem that the Department of Energy should be working on, with massive resources, is simply the alteration of the closed current loop circuit so that it does not destroy the source dipole faster than it powers the loads. Secondly, they should then be working on how to close-loop the COP>1.0 EM systems that readily emerge from that research. Yet it appears that this fundamental energy problem — and the *only* energy problem — has no conventional work being openly done on it anywhere in the open Western world.<sup>88</sup>

### 3.8 Dark Positive Energy: The Unaccounted Heaviside Component

Now we restate a deceptively hidden thing: The EM field and potential are defined as the observed effect of the deviation from them by an assumed unit point charge. Then that same field and potential are assumed to be in mass-free space, before the interaction with charged matter. Hence the

<sup>88</sup> Using the U.S. as an example, the U.S. classified community is highly compartmented, and the real "organization" of a given compartment often consists of laterally connected "same clearance" compartments in multiple outside agencies rather than vertical chain of command through one agency. We accent that some highly compartmented "lateral" classified organizations in the West and elsewhere already have working COP>1.0 systems, and have had them for several decades. Some of these laterals in the U.S. are very dedicated to the duly elected government of the United States, with good national security reasons for the fact that they "**officially** do not exist". Some are not so dedicated at all, and have their own agendas having little if anything to do with official U.S. government policy. These latter "rogue" laterals often have convenient connections with outside shadowy **groups** of the High Cabal (Churchill's phrase). A similar situation exists in several **other** major foreign nations. Substantial electrodynamic technology has been developed (and weaponized) for decades, in secret, and this technology does not **appear** in the open news, the university texts, or the scientific journals. Such is the case for COP>1.0 EM power systems, which have actually existed in secret for **decades**.



field and potential have each been defined erroneously as both a cause and an effect. This is a gross non sequitur. There is also a total lack of accounting that all EM energy in 3-space comes from the time domain. There is no consideration that every dipolarity and every charge represents a giant circulation of EM energy between time and 3-space. In ensemble, this non sequitur and these omissions are responsible for most of the present formidable foundations problems in electrodynamics.

We submit the following new hypothesis: *The present "definition" of field and potential as a function of interception and divergence by a unit point static charge are only indications of their point intensity, obtained as an estimate after their observed interaction with a unit point static charge.<sup>89</sup> Thus the actual field and potential contain not only their Poynting components that interact with the unit point charge, but also their Heaviside nondiverged components that do not interact with it. The true "magnitudes" of the massless field and potential prior to interaction with charged mass are many orders of magnitude greater than the magnitudes of their standardized point intensities {215}.*

In short, we propose that *every field and potential, in its interaction with charged mass, produces not only the accounted energy aspects presently calculated by electrodynamicists and astrophysicists, but also contains Heaviside's vast unaccounted "dark positive energy" component presently discarded.* We further propose that this ubiquitous and unaccounted "dark positive EM energy" component in the interactions of the fields and potentials of the spiral galaxies is what is producing the excess gravity that is holding the spiral arms together. We specifically do this in honor of Heaviside, whose unpublished papers clearly establish that he recognized the overwhelming gravitational importance of his extra and unaccounted energy flow component {172a, 172b, 196}.

## 3.9 A Short History of the Discarding of the Heaviside Dark Energy

### 3.9.1 Independent Work by Heaviside and Poynting

Let us now see how the enormity of the EM energy flow from the dipolar source was treated in the early electrodynamic theory, and how it is treated in the received view today.

<sup>89</sup> This is recognized by leading electrodynamicists, but not by most electrical engineers building power systems!

In the 1880s after Maxwell was already deceased, Poynting {216} and Heaviside {217} independently (and rather simultaneously) discovered EM energy flow through space. Before that, the concept did not appear in physics. Poynting {216} published prestigiously, while at first Heaviside published more obscurely {217}, then finally more prestigiously {218, 219}.

With respect to circuits, from the beginning Poynting assumed only that small amount of EM energy flow that enters the circuit from the surrounding space. Here are Poynting's {220} own words:

*"This paper describes a hypothesis as to the connexion between current in conductors and the transfer of electric and magnetic inductions in the surrounding field. The hypothesis is suggested by the mode of transfer of energy in the electromagnetic field, resulting from Maxwell's equations investigated in a former paper ("Phil. Trans., " vol. 175, pp. 343-361, 1884). It was there shown that according to Maxwell's electromagnetic theory the energy which is dissipated in the circuit is transferred through the medium, always moving perpendicularly to the plane containing the lines of electric and magnetic intensity, and that it comes into the conductor from the surrounding insulator, not flowing along the wire. "*

As can be seen, Poynting considered only the energy flow actually entering the wire, and subsequently being dissipated in the circuit. Hence Poynting never considered the huge EM energy flow component around the circuit that is *not* diverged, *misses* the circuit entirely, *does not* contribute to the energy dissipated by the circuit, and is *wasted*. In short, there is a vast "dark energy flow" associated with every dipolar interaction — a huge energy flow component which Poynting never considered.

Heaviside's theory was an extension of what Poynting had considered, and Heaviside also corrected Poynting as to the direction of flow. Heaviside was fully aware of the enormity of the "dark energy" flow missed by Poynting, but had absolutely no explanation as to where such a startlingly large EM energy flow — pouring from the terminals of every dipole, generator, or battery — could possibly be coming from. Consequently, Heaviside was very cautious in referring to it, usually doing so only obliquely in terms of the angles and components. In Heaviside's {221} own words:

*"It [the energy transferflow] takes place, in the vicinity of the wire, very nearly parallel to it, with a slight slope towards the wire... . Prof. Poynting, on the other hand, holds a different view, representing the transfer as nearly perpendicular to a wire, i.e., with a slight departure from the vertical. This difference of a quadrant can, I think, only arise from what seems to be a misconception on his part as to the nature of the electric field in the vicinity of a wire supporting electric current. The lines of electric force are nearly perpendicular to the wire. The departure from perpendicularity is usually so small that I have sometimes spoken of them as being perpendicular to it, as they practically are, before I recognized the great physical importance of the slight departure. It causes the convergence of energy into the wire. "*

As can be seen, Heaviside was fully aware that the energy flow diverged into the wire was only a minuscule fraction of the total. He was fully aware that the remaining component was so huge that the energy flow vector remaining — after the divergence of the Poynting component into the circuit — was still almost parallel to the conductors. However, he had no explanation at all of where such an enormous and baffling energy flow could possibly originate.

Had Heaviside strongly stated the enormity of the nondiverged component of the energy flow, he would have been viciously attacked and scientifically discredited as a perpetual motion advocate. His words were measured and cautious, but there is no doubt that he recognized the enormity of the nondiverged EM energy flow component.

We have chosen to call that huge unaccounted component the "Heaviside dark energy component" in his honor, since he actually discovered it. By the word "dark" we mean "unaccounted", which hides it from scientific view. We have also nominated it as the previously unsuspected source of the extra gravity holding the arms of the spiral galaxies together.

### **3.9.2 Lorentz Disposed of the Problem Rather than Solving It**

Lorentz then entered the EM energy flow scene to face the terrible problem so quietly raised by Heaviside. Lorentz understood the presence of the Poynting component, and also of the extra Heaviside component, but could find no explanation for the startling, enormous magnitude of the EM energy pouring out of the terminals of the power source (pouring from the source dipole) {222} if the Heaviside component was accounted. Had

he retained and advanced this enormous dark energy flow component, even the great Lorentz would have been castigated as a perpetual motion advocate who did not accept the law of energy conservation. Even today, when one points out that far more energy is pouring out of the terminals of every generator than the small mechanical energy input to the shaft, one is immediately labeled a raving lunatic — even though the Bohren experiment {24} clearly proves the presence of an extra energy flow component not usually intercepted. It is not difficult to understand how such a bombshell would have been received in the 1880s! At least today, we have particle physics and its broken symmetry of opposite charges, together with its active vacuum, to explain where the excess energy comes from and how.

Unable to *solve* the dark energy flow problem by any rational means, Lorentz found a clever way to *avoid* it. He reasoned that the nondiverged Heaviside component was "physically insignificant" (his term) because it did not even enter the circuit. Since it did nothing of any physical consequences, or so he reasoned, then it could just be discarded.

So Lorentz simply integrated the entire energy flow vector (the vector representing the sum of both the Heaviside nondiverged component and the Poynting diverged component) around an assumed closed surface enclosing any volume of interest {223}. *A priori*, this mathematical procedure discards the dark *Heaviside* energy flow component because of its nondivergence. It retains only the intercepted *Poynting* diverged component that enters the circuit.

A century later, electrodynamicists are still happily avoiding the dark energy flow problem by continuing to use the Lorentz integration procedure {224} to dispose of all but the Poynting component that enters the circuit and is then dissipated by the circuit. As a result, the "Poynting energy flow" has come to be loosely regarded as "the" entire EM energy flow, though electrodynamicists find it necessary to give stringent warnings about it. E.g., Panofsky and Phillips {225} state it this way:

*"...only the entire surface integral of N [their notation for the Poynting vector] contributes to the energy balance. Paradoxical results may be obtained if one tries to identify the Poynting vector with the energyflow per unit area at any point."*

Most electrodynamicists note the freedom to add a vector — few call it an *energyflow* vector, though that is the type of vector being discussed, and

one must add apples to apples — which has zero divergence. Jones {226} states:

*"It is possible to introduce the Poynting vector  $S$ , defined by  $S = E \times H$ , and regard it as the intensity of energy flow at a point. This procedure is open to criticism since we could add to  $S$  any vector whose divergence is zero without affecting [the basic integration procedure's result]."*

Jackson {227} says it even more plainly, and also uses Lorentz's "no physical significance" argument for disposing of any energy flow vector with a zero divergence. Quoting:

*"...the Poynting vector is arbitrary to the extent that the curl of any vector field can be added to it. Such an added term can, however, have no physical consequences."*

Any energy flow vector, which is the curl of a vector field, will have zero divergence, by elementary vector algebra. In short, to be pertinent at all, it must be an *energy flow* vector (since energy flow is what  $S = E \times H$  is all about. Since the curl of any vector has no divergence *a priori*, then any energy flow vector that is a curl of a vector field will be part of the Heaviside dark energy flow component, rather than part of the Poynting energy flow component. It will also be discarded by Lorentz's closed surface integration.

We refer the reader again to Figures 2-5 and 2-6 in Chapter 2, p. 113-114. Electrodynamacists err in assuming that such a divergent free vector (energy flow) can have no physical consequences. If one inserts *additional intercepting charges* into that formerly nondiverged energy flow component, the charges will immediately diverge some of the formerly nondiverged energy flow around them and hence "collect additional energy". In other words, "divergence" is the result of a physical process, accomplished by intercepting charges. We can easily change "nondiverging" energy to diverging energy, by simply interacting it with charges. We can also "bunch" the energy flow lines closer together (as in some waveguides), thereby increasing the local flow intensity and the concomitant energy collected by each intercepting charge in the densified energy flow stream.

So whether the Heaviside energy flow component is of physical consequence or not, depends on whether or not we "add more sail to the sailboat", or "add more sailboats" before the wind. That is most certainly a

useful physical consequence, and with a little ingenuity we ought to be able to use it to power loads "for free" or nearly so. There are other consequences also, as we used in deriving the negentropy of the dipole or charge. There the input of a non-Poynting energy flow component certainly has universal and physical significance — e.g., to the curving of local spacetime, conditioning the active vacuum, furnishing all the energy to form the EM fields and potentials from their source charges, etc.

Schwarz {228} expresses it this way:

*"There will be many opportunities in which the interpretation of  $E \times H$  as a rate of flow of energy per unit area will be profitable. In most cases of practical interest, such an interpretation is valid, although it must always be kept in mind that only the integral of  $S$  over a closed surface can be physically measured... Just how it is that the connections to the energy source, say a battery, are at the ends of the wire, yet energy flows in through the sides, should be pondered by the reader. "*

Note carefully that Schwartz recognizes the difference between the observed (deviated or diverged) part of the EM energy flow and the unobserved nondeviated or nondiverged part of it. However, he did not follow it up and apply it back to the basic "definition" of the field and potential as what are diverged from them.

For recommended changes to the Poynting vector, Jones {229} presents many conditions the changed vector must fulfill. Then he falls back on the Lorentz closed surface method again, but without realizing that he therefore (i) first includes both the diverged and nondiverged component, and (ii) invokes a procedure that arbitrarily discards the nondiverged component. In thus disposing of the problem, Jones says:

*"It does not seem likely that an expression satisfying all these conditions will be simple.....fortunately, we are rarely concerned with the energy flow at a point. In most applications we need the rate at which energy is crossing a closed surface."*

**Finally**, we note that even today, a debate on what the Poynting vector is or should be, is still politely ongoing. As an example, it has been ongoing for more than 40 years in the *American Journal of Physics* alone as well as in other journals {230a-230i}. One thing is clear: The Poynting vector does not represent the total energy flow at right angles through a square

meter in space surrounding the conductors of the electrical circuit. It is, however, the *component or fraction* of that actual energy flow through the square meter in force-field-free form *that will subsequently be diverged and collected in the circuit in force-field form and dissipated in the circuit loads and losses.*

### 3.10 The Problem of the Accelerating Expansion of the Universe

As briefly stated earlier, we introduce the notion of the supersystem, consisting of three parts: (i) the system and its dynamics, (ii) the active vacuum and its dynamics, and (iii) the active spacetime curvatures and their dynamics. All three components of the supersystem interact with each other.

In Chapter 9, we explain in some detail how a  $COP > 1.0$  EM circuit — and especially a  $COP \gg 1.0$  EM circuit — has an induced flow of negative energy (Dirac sea hole current) from the output section of the system, back through the system, and into the input section. Reaching the input section, if the hole flow is not completely filled by incoming electrons, the remaining Dirac hole current will flow on back into the feeder line from the external power supply, and into the distant power supply itself, eating electrons and electron current all the while.

We also explain our reinterpretation of the *unobserved* (non-reacted) Dirac hole with negative energy or negative mass, without time reversal and parity reversal. This dramatically differs from the "as observed" (interacted) Dirac positron with positive mass, and with charge-reversal and parity reversal from the electron. The Dirac hole is "as unobserved and non-reacted" and it is still an *electron* having negative mass and negative energy. The Dirac positron with positive mass, opposite charge, and opposite direction is "as observed and reacted with charged matter". The unobserved Dirac hole is the "cause" of an observational interaction; the Dirac positron is the "effect" of an observational interaction. The two are very different because the cause differs from the effect. Here again, the confusion of cause and effect has had very detrimental consequences in the use of Dirac's electron theory.

Very powerful astronomical phenomena, such as giant astronomical explosions of great energy, involve  $COP > 1.0$  and  $COP \gg 1.0$  processes, particularly when the unaccounted Heaviside energy flow is accounted for every field and potential interaction with charged mass. Hence all such phenomena also provide very powerful "explosions" of negative energy

(Dirac sea holes moving outward in the vacuum). The negative energy is the equivalent of negative mass, so long as it is unobserved.

So there is a "dark negative energy explosion" in the Dirac Sea vacuum, accompanying every large astronomical explosion seen through our telescopes and other sensors. This accompanying dark negative energy explosion has not been accounted in astrophysics until now.

We thus live in an astronomical universe of neglected "giant dark negative energy explosions" as well as one of accounted "giant positive energy explosions".

The dark (unaccounted) negative energy radiating outward in the vacuum from gamma bursts, x-ray bursts, etc. produces antigravity. The spreading negative energy, moving at light speed, is a change to the vacuum itself, which also interacts upon spacetime to negatively curve it, producing negative gravity. For those energetic processes of COP sufficiently greater than one, the processes produce more antigravity than gravity. As of this writing, we are in fact filing a patent application on this method of performing and producing antigravity, and it will be filed before this book is published.

Over the 14 billion or so years of the observed universe, the dark negative energy content of spacetime has been slowly changing by the results of giant astronomical explosions and other such processes producing negative energy radiated outward into the Dirac sea vacuum. Slowly the vacuum itself has undergone transformation from the perfect Dirac sea with all holes filled by particles, to a vacuum where there is a slowly growing fraction of negative energy (negative mass) unobserved Dirac sea holes.

Thus, slowly the antigravity generated by the gradual altering of "space" (the vacuum) itself has been growing for some 14 billion years. At some point in the past, the excess antigravity effect accumulating in space reached the equal of the "outside" gravity acting upon energetic explosive astronomical phenomena. From that point in time, the antigravity effect has been increasing slowly. The result is that the present violently explosive astronomical phenomena, by adding a sudden and sharp increase in their external space antigravity, produce acceleration away from all positive mass and positive energy phenomena. Hence astronomers now observe the acceleration of the expanding (positive energy/positive mass) universe, instead of the previously expected slowing (due to positive gravity) of the expanding universe (conventional view).



The antigravity-producing phenomena have not been openly investigated in Western science because Western science has arbitrarily discarded  $COP > 1.0$  EM systems, primarily with the Lorentz regauging of the Maxwell-Heaviside equations. Hence, Western science has not experimentally studied the type of system that produces the effect in the first place.

On the other hand, it is possible to directly investigate the antigravity-producing phenomenology on the laboratory bench, by utilizing overunity EM systems with very high COP (e.g.,  $COP = 10^6$  or more). The Sweet experiments {231} did in fact produce such phenomenology on the laboratory bench, but these experiments were privately performed under proprietary conditions {232}. We discuss the Sweet experiments and device in a later chapter.

In science, such experiments are quite properly deemed interesting but anecdotal until replicated independently. Similar experiments should certainly be repeated by the scientific community, using various interactions (some given in this book) that develop  $COP > 1.0$ . The problem is nowhere near as difficult as hot fusion, but it has not been tackled and overcome because of (1) the prevailing and erroneous scientific mindset against  $COP > 1.0$  electromagnetic processes, and (2) the present "kill" of the supersystem and its effects in the standard U(1) electrodynamics model.

In Chapter 8 we further discuss the antigravity effect in practical or potentially practical systems where  $COP \gg 1.0$ .

### 3.11 In Conclusion

In this Chapter, we have stressed what we believe to be a great new principle of giant negentropy, leading to direct and easy extraction of EM energy from the vacuum in copious quantities. That principle is that nature retains *her preferred 4-symmetry* of EM energy flow, while breaking 3-symmetry of EM energy flow and the symmetry of EM time-energy flow on the fourth axis. It is implemented by making a common dipole or charge.

The electrical energy problem is *not* due to any difficulty in inducing giant and indefinitely continuing EM energy flows from the vacuum! The easiest thing in the world is to extract EM energy — any amount, anywhere, anytime — from the seething vacuum, by making a simple dipolarity. The problem is only in then intercepting and collecting some of the energy to dissipate in loads, and doing it *without* using half the collected energy to

destroy the dipole producing the energy, faster than the loads are powered. In other parts of this book we have given some of the many mechanisms that can be applied to attack this "power the load without killing the source dipole" problem, and have also included such in papers in the literature {233a-233u}.

We have pointed out the implications of the new principle of negentropy in EM energy flow, and how all our circuits and electrical power systems actually use it but then are designed so as to kill the negentropic process's potential for self-powering electrical power systems.

Presently we are told by the conventional scientific community that the dream of freely extracting EM energy from the vacuum, and using it to efficiently and easily power our electrical needs cleanly, is either a fool's concept of perpetual motion, or the science of the next century. It is neither; it is good physics, and it is already *present and misused* in all our electrical power systems and circuits — and always has been. Unlimited electrical energy from the vacuum is here and now, if we but overcome the prevailing mindset and grasp it.

We have argued that all electrical loads and circuits are now and always have been powered by just such EM energy extracted directly from the vacuum by the giant negentropy principle, evoked by the source dipole. We have removed the artificial and erroneous notion that batteries and generators provide some of their available 3-space internal energy to the external circuit. Instead, we have emphasized that batteries and generators dissipate their available energy to form and then continually reform their source dipole, and nothing else. Once their source dipolarity is formed, a battery or a generator is nothing but an energy gate, gating and transducing enormous EM energy from the vacuum. We only have to keep inputting energy to keep reforming the dipole that our external circuit is designed to destroy faster than the load is powered.

In dealing with the function of the dipole in extracting the EM energy from the vacuum and pouring it out to power the circuit, we have shown errors in present energy flow theory and how they came to be made. We also indicated the enormous magnitude of the EM energy flow actually **extracted** and present with every conventional circuit, but wasted and **arbitrarily** removed from accountability. Some processes for intercepting, **collecting**, and using additional amounts of this available Heaviside "dark EM energy" flow component, surrounding every circuit, have been mentioned, and references have been given to other papers more fully discussing such processes. In a previous paper {234} we have proposed

that the Heaviside dark energy, accompanying all EM field-charge interactions, is responsible for the excess gravity observed to be holding the spiral arms of those distant spiral galaxies intact — in short, we have proposed an unaccounted Heaviside *dark positive energy* solution to the well-known *dark matter* problem in astrophysics.

The ordinary closed current loop circuit inherently yields a system  $COP < 1.0$ , because it destroys its source dipoles faster than it powers the load. Indeed, the circuit self-enforces the Lorentz symmetrical regauging condition during discharge of its free excitation (potential) energy.

In addition, we have presented an hypothesis to explain that negative energy (negative mass) created in the Dirac sea vacuum by giant astronomical explosion phenomena produces the excess antigravity in the space surrounding those entities that is accelerating the expansion of the universe. We have also indicated how this hypothesis can be investigated and tested on the bench. We have provided one experiment whose results did support the hypothesis.

The present world energy crisis is real and increasing, while at the same time the availability of oil is beginning to decrease and oil becomes more costly.<sup>90</sup> Unless a substantial fraction of the "electricity from oil" curve is shifted to "electricity from the vacuum" rather quickly, the economic collapse of the Western world, followed by concomitant collapse of other economies, may ensue within a surprisingly few years, and even within the present decade.

<sup>90</sup> As this was first being written in Dec. 2001, there was a temporary relief in the oil crisis, due to the sudden decrease in travel, air traffic, etc. after the terrorist attack on Washington and New York on September 11, 2001. As the present war on terrorism has continued, the MidEast is now heating up toward another war, and oil prices are again trying to climb. Iraq, Iran, and Libya called for an oil embargo on the United States, for example, which would almost immediately plunge the nation into an oil crisis. Meanwhile, should effective terrorist attacks occur upon the highly vulnerable energy distribution infrastructure of the United States and other allied nations, the oil crisis will again emerge catastrophically and almost immediately thereafter. It is held off for now, only because Russia under Putin is seeking U.S. financial assistance to further develop its rich oilfields. When OPEC votes to curtail production and then curtails it, Russia opens the spigot and keeps the prices down. Putin is seeking to become a trusted U.S. oil partner, in the role long played by Saudi Arabia but now declining due to perceived Saudi payments to terrorist organizations and reluctance to close down terrorist activities in their own country. So in a strange way, a new alliance between the U.S. and Russia has prevented the oil and energy prices from escalating right through the roof.

We believe that a transfer of much of the "electricity from oil" curve to an "electricity from the vacuum" curve can be quickly accomplished, if the government and the scientific community can be induced to move with full priority and vigor in the directions indicated in this book. However, to get that done, it apparently will be done over the writhing bodies of our leading scientific organizations, literally dragging the organizations to face the proven fact of giant negentropy of every charge and dipole in the universe over their strenuous objections.

As a major objective, we fervently hope that undergraduate students, graduate students, post-doctoral scientists, other scientists, engineers, and environmentalists will interest themselves in these new principles and viewpoints. We have called attention to the new electrodynamics pioneered by AIAS, Evans, Sachs, Barrett, Lehnert, and others, and indicated the capability of this emerging electrodynamics to model this new *energy from the vacuum* functioning.

It has been said that no idea is accepted until its time has come. We strongly believe that the time for cheap, clean extraction of electrical energy from the vacuum is an idea whose time has arrived. Hopefully our efforts in this book will at least conceptually show the interested reader the outline and course that energy from the vacuum can and will take in the scientific community and in the world at large.

We accent again that modeling the extraction of EM energy from the vacuum demands the use of higher symmetry electrodynamics, particularly a theoretical model capable of expressing the interactions of the three components of the supersystem. Barrett and Grimes {235} said it beautifully:

*"In the case of electromagnetism, the theory was first simplified before being frozen. Maxwell expressed electromagnetism in the algebra of quaternions and made the electromagnetic potential the centerpiece of his theory. In 1881 Heaviside replaced the electromagnetic potential field by force fields as the centerpiece of electromagnetic theory. According to him, the electromagnetic potential field was arbitrary and needed to be "assassinated" (sic). A few years later there was a great debate between Heaviside and Tait about the relative merits of vector analysis and quaternions. The result was the realization that there was no need for the greater physical insights provided by quaternions if the theory was purely local, and vector analysis became commonplace.*

*The vast applications of electromagnetic theory since then were made using vector analysis. Although generations of very effective students were trained using vector analysis, more might be learned physically by returning, if not to quaternions, to other mathematical formulations in certain well-defined circumstances. As examples, since the time when the theoretical design of electromagnetism was frozen, gauge theory has been invented and brought to maturity and topology and geometry have been introduced to field theory. Although most persons view their subject matter through the filter of the mathematical tools in which they are trained, the best mathematical techniques for a specific analysis depend upon the best match between the algebraic logic and the underpinning physical dynamics of a theoretical system. "*

The problems we face today are ever more demanding of the necessary EM change pointed out by Barrett and Grimes, along with many others. Let us hope their words are heeded. Given rapid development of higher group symmetry electrodynamics models, we shall very rapidly see the solutions to many previously intractable human problems — including cheap clean energy from the vacuum, understanding and directly using antigravity as well as gravity, a revolutionary new medical therapy, a new chemistry and biochemistry, and a new appreciation for the electromagnetic interactions of mind and matter.

Let us hope this new scientific revolution comes swiftly.

## Chapter 4

# Setting the Stage for Understanding Overunity Power Systems

[Dissipative structures] *"This leads precisely to a distinction between 'equilibrium structures' [which may be understood in terms of classical equilibrium thermodynamics] and 'dissipative structures'. The latter are formed and maintained through the exchange of energy and matter in non-equilibrium conditions."* [I. Prigogine] {236} [Internal brackets added for clarity.]

[The energy in space itself] *"What might appear to be empty space is, therefore, a seething ferment of virtual particles. A vacuum is not inert and featureless, but alive with throbbing energy and vitality. A 'real' particle such as an electron must always be viewed against this background of frenetic activity. When an electron moves through space, it is actually swimming in a sea of ghost particles of all varieties — virtual leptons, quarks, and messengers, entangled in a complex melee. The presence of the electron will distort this irreducible vacuum activity, and the distortion in turn reacts back on the electron. Even at rest, an electron is not at rest: it is being continually assaulted by all manner of other particles from the vacuum."* [Paul Davies] {237}

[Modernizing the fluid analogy of EM]. *The intensity of the vacuum virtual particle flux may be treated as the intensity of a potential, thus by analogy corresponding to pressure in a fluid. Polarity (charge) is a process for establishing a change in the intensity of the vacuum potential — and thus a change in the ambient pressure of the vacuum fluid. Difference between vacuum pressures at two separated points creates a force upon any charge placed between those two points. Just as a differential in pressure between points in a fluid induces currents, a differential in vacuum pressure induces energy flow currents in the vacuum fluid, which are called 'fields'. All*

*EM circuits, charges, potentials, and forces in electrodynamics involve altering the vacuum to include altering its pressure and thereby producing the forces that the resulting pressure gradients (fields) induce upon charges. All observable EM energy in space is EM energy intercepted and collected on charges, and it comes from the vacuum via these fundamental vacuum-engineering dynamics.*" [T. E. Bearden, private communication to a colleague, 2001].

[Impact of EM energy from the vacuum.] *"If they [quantum fluctuations of vacuum] can be [tapped], the impact upon our civilization will be incalculable. Oil, coal, nuclear, hydropower, would become obsolete — and so would many of our worries about environmental pollution." "Don't sell your oil shares yet — but don't be surprised if the world again witnesses the four stages of response to any new and revolutionary development: 1. It's crazy! 2. It may be possible — so what? 3. I said it was a good idea all along. 4. I thought of it first."* [Arthur C. Clarke] {238}.

[Broken symmetry of opposite charges.] *"Since nonobservables imply symmetry, any discovery of asymmetry must imply some observable. The experiment of Wu, Ambler, Hayward, Hoppes and Hudson... established the asymmetry between the positive and negative signs of electricity."* [T. D. Lee] {239}.

[On implications of asymmetry of opposite charges of a dipole.] *"In particle physics, the proven asymmetry of opposite charges establishes that the source dipole — with opposite charges on each end — is a broken symmetry in the violent virtual photon flux of vacuum. The dipole charges constantly receive and absorb virtual photon energy from the seething vacuum, and re-emit that excitation energy. By the very definition of broken symmetry, some of this absorbed virtual energy must be integrated into observable 3-space EM energy, and emitted by the dipole in observable form, in all directions in 3-space. Hence there is a rigorous basis for the source dipole extracting virtual EM energy from the vacuum, integrating it, and continuously pouring it out in*

*observable and usable EM energy form. It has been in particle physics since 1957, being certified by the award of the Nobel Prize to Lee and Yang in that year. " [T. E. Bearden, private communication to a colleague, 1995.]*

*[On powering an electromagnetic circuit] "In the United States there is not now, and there never has been, a single electrical engineering department, professor, or textbook that knows and teaches what directly powers an electromagnetic circuit. Neither is it in any publication of the National Academy of Sciences, National Science Foundation, National Academy of Engineering, Department of Energy, or the great national laboratories. Yet the proof that every circuit is powered by EM energy extracted directly from the vacuum has been in particle physics for 45 years, since the award of the Nobel Prize to Lee and Yang in 1957, following the experimental proof by Wu et al. earlier that same year. " [T. E. Bearden, private correspondence, 2002].*

## 4.1 Introduction

In this chapter, we present a selection of potential overunity notions, some inventions, and some experiments. Its purpose is to show some of the more relevant work that has been done, and hopefully to stimulate new thinking by the interested reader. Much of the work addressed is by other inventors and scientists, and we give an appropriate commentary from our viewpoint. Not all the concepts presented can be clearly explained, though some can and are. This is not intended to be a "kit of parts" or an "assembly instructions" type of presentation. For that, the interested researcher will have to rely on his or her own ingenuity and lots of bench experiments, because no such "kit of parts with instructions" for COP > 1.0 electrical power systems exists at present {240, 241}.

Because of the broken symmetry of its opposite charges, we do know that any dipolarity — such as a permanent magnet, a charged flat-plate capacitor, an electret, or a simple EM scalar potential — continuously pours out EM energy circulation extracted from the vacuum. E.g., see Figure 4-1, which shows a very simple "free energy generator" that will generate a flow of EM energy indefinitely, even by ordinary U(1) electrodynamics theory (by standard Poynting theory). E.g., quoting Buchwald {242}:



*"[Poynting's result] implies that a charged capacitor in a constant magnetic field which is not parallel to the electric field is the seat of energy flows even though all macroscopic phenomena are static."*

This is easily seen by applying the standard Poynting formula,  $S = E \times H$ . With the H-field of the magnet at right angles to the E-field of the capacitor or electret, the Poynting flow of energy  $S$  is maximized and orthogonal to  $E$  and to  $H$ .

The problem is not in extracting energy - even enormous energy — from the vacuum. The problem is collecting and using the energy to power loads, without destroying the source dipole.

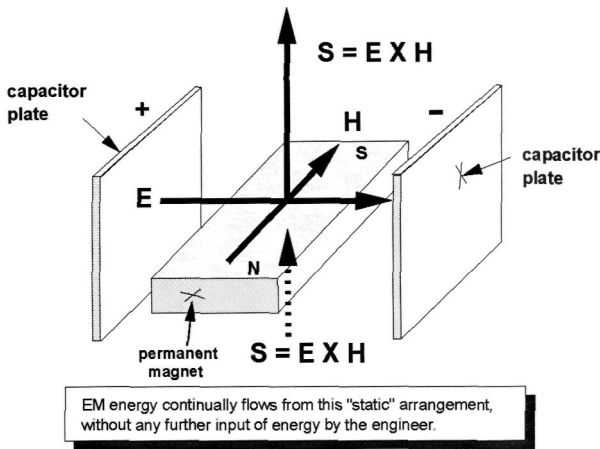

Figure 4-1 Poynting generator providing endless EM energy flow from the vacuum.

Buchwald errs, e.g., in assuming the macroscopic phenomena are static. They are not; they are highly dynamic in the same sense that a perfect macroscopic whirlpool in a river, seemingly static, nonetheless involves a continuous flow of water through it and a continuous dynamics. So far as can be observed, it appears there is no such thing as a truly "static" object. As an example, just to "exist" an object must "travel through time", which is itself a special kind of dynamics in the time domain.

A beautiful explanation of what is meant by "static" is given by Van Flandern<sup>91</sup>:

*"To retain causality, we must distinguish two distinct meanings of the term 'static'. One meaning is unchanging in the sense of no moving parts. The other meaning is sameness from moment to moment by continual replacement of all moving parts. We can visualize this difference by thinking of a waterfall. A frozen waterfall is static in the first sense, and a flowing waterfall is static in the second sense. Both are essentially the same at every moment, yet the latter has moving parts capable of transferring momentum, and is made of entities that propagate. "*

Now suppose that the capacitor in Figure 4-1 is rotated until E and H are either parallel or anti-parallel. In that case, the Poynting theory predicts zero EM energy flow. That is an incomplete assessment; it means that there is no overt field energy flow. There is, however, still quite a lot of covert or "infolded" field energy flow ongoing anyway, inside the static fields E and H themselves.<sup>92</sup> To see this, we first turn to the static potentials.

Between the charged plates of the capacitor or electret, there exists an electrostatic scalar potential  $\phi$ . Between the polar ends of the permanent magnet, there exists a magnetostatic scalar potential  $\Phi$ . We may independently decompose both  $\phi$  and  $\Phi$  via Whittaker decomposition {243}, applying a necessary correction {244} to Whittaker's interpretation. Then in all space surrounding the two dipoles, we have a hidden harmonic set of bidirectional longitudinal EM wavepair flows of energy comprising each of the static potentials  $\phi$  and  $\Phi$  filling all space<sup>93</sup> around the assembly in Figure 4-1. Each of those potentials  $\phi$  and  $\Phi$  is formed of a combination of scalar (time-polarized) and longitudinal photon pairs, as strongly argued

<sup>91</sup> Tom Van Flandern, "The speed of gravity — what the experiments say," *Phys. Lett. A.*, Vol. 250, Dec. 21, 1998, p. 8-9.

<sup>92</sup> Indeed, by the asymmetry of its opposite charges, each of the dipoles is **continuously** pouring out EM energy extracted from the seething vacuum.

<sup>93</sup> In the conventional view. We corrected that view in {12}, to agree with quantum field theory and to use a *cause and effect* instead of the *two effects* used by Whittaker.

by Mandl and Shaw {245} and as previously discussed in an earlier chapter. Further, each of the "static" fields can be decomposed into two scalar potential functions, as shown in 1904 by Whittaker {246}. Then each of the base scalar potentials further decomposes into the set of time-polarized EM wave and longitudinal EM wave pairs. The result is that every "static" field or potential in the universe is actually a set of longitudinal EM wave dynamics.

Further, in each coupled Whittaker wavepair as reinterpreted, there is perfect correlation between the time-domain EM energy wave (scalar or time-polarized EM wave) and the 3-space longitudinal EM wave. So even a "static" EM field, such as from the permanent magnet and from the charged capacitor or electret, does involve an enormous number of hidden internal EM energy flows in longitudinal and scalar EM waveform.<sup>94</sup>

<sup>94</sup> One of the great omissions of modern Western electrodynamics is the failure to follow up on direct engineering of this "vast, internal, infolded, far more fundamental" scalar and longitudinal electrodynamics hidden inside all present overt EM potentials and transverse EM fields and waves. Russian secret weapon scientists under the former KGB called this internal electrodynamics the "information content of the field" and have strongly weaponized it. A deception plan has been used to successfully convince the West that the Russians are speaking only of conventional spectral analysis. Use of this internal EM structuring, in the form of longitudinal or scalar wave interferometry, formed the first giant superweapons deployed by the former Soviet Union in 1963. To see a proof that ordinary EM fields and waves and potentials can be formed at a distance, *arising out of the local spacetime in the interference zone*, see M. W. Evans et al., {79}. Longitudinal EM waves easily pass through the entire earth and ocean relatively undiminished, since mass is mostly empty space filled with fields, potentials, and waves — i.e., filled with incredible numbers and bundles and dynamics of longitudinal and scalar EM waves. Mass is thus a great superhighway for the passage of longitudinal EM waves, and longitudinal interferometry can be performed right through the earth and ocean, on the other side of the earth from the transmitters. Such interferometers can also easily focus inside the earth or beneath the surface of the ocean. Hence in April 1963 the first giant Soviet LW interferometer deployed was used to kill the U.S.S. Thresher beneath the ocean, off the East Coast of the U.S. Intense production of EM signals — emerging everywhere in the space in that underwater interference zone placed around the submarine — filled the sub and its electronic controls. This jammed the electronic controls of the sub, rendering it helpless. The hapless sub then sank to crush depth and imploded. The signatures are clearly present in the jamming and cessation of multiple electronic systems functioning in the sub's surface companion, the U.S.S. Skylark (which was in a sort of surrounding "splatter" zone and survived because it was not individually targeted). Today at least 10 nations have scalar or longitudinal wave interferometer weapons, to one extent or another, other nations are working on them, and the Yakuza also has them. These were apparently the weapons

Ultimately there is no frozen waterfall, but only the dynamic waterfall always reappearing the same but filled with dynamic movement and energy flow.

These latter EM energy flows *infolded inside* the scalar potentials and the **fields** exist for a single charged capacitor or electret alone, or a single magnet alone. They also exist for any two points in a circuit that have differing electrical or magnetic potentials with respect to the ambient vacuum potential (energy density). This latter fact, of course, was part of the secret of Kron's *open path*. Indeed, every dipolarity in the universe — between any two potentials or any two differing charges anywhere — is an open path and an energy flow source. E.g., quoting Kron {247}:

*"...the missing concept of "open-paths" (the dual of "closed-paths") was discovered, in which currents could be made to flow in branches that lie between any set of two nodes. (Previously— following Maxwell— engineers tied all of their open-paths to a single datum-point, the 'ground'). That discovery of open-paths established a second rectangular transformation matrix... which created 'lamellar' currents... " "A network with the simultaneous presence of both closed and open paths was the answer to the author's years-long search. "*

As can be seen, Kron had discovered how to create currents — *currents could be made to flow* — in individual branches between any two nodes in **the** circuit, physically connected or not. We point out that deliberate use of Kron's "open path" in a network circuit constitutes a strong violation of **the** standard closed current loop circuit's self-enforcement of the Lorenz/Lorentz symmetrical regauging condition. Hence it is a magnificent method for achieving COP>1.0 circuits. It is the belief of this

confirmed in 1997 by Secretary of Defense Cohen in these words: "*Others are engaging even in an eco-type of terrorism whereby they can alter the climate, set off earthquakes, volcanoes remotely through the use of electromagnetic waves... So*

*there are plenty of ingenious minds out there that are at work finding ways in which they can wreak terror upon other nations...It's real, and that's the reason why we have to intensify our efforts.*" [Secretary of Defense William Cohen at an April 1997 DoD counterterrorism conference sponsored by former Senator Sam Nunn. Quoted from DoD News Briefing, Secretary of Defense William S. Cohen, Q&A at the Conference on Terrorism, Weapons of Mass Destruction, and U.S. Strategy, University of Georgia, Athens, Apr. 28, 1997.]. As the reader can see, the Cold War **was** not so "cold" after all. This mere "tip of the iceberg" should also give the reader a little more insight as to why a war on terrorism is so necessary to all civilized nations.

author that such "open path" functioning in his patented circuits was part of Tesla's secret, though he did not think of it in those terms. However, Tesla's ability to shuttle potential energy independently in his circuits — invisible to a tensor analysis — was rigorously shown by Barrett {124}. Barrett extended the method and obtained two patents in the field of communications {286a, 286b}.

Thus the  $COP > 1.0$  problem *is not* in the part or function (the dipole or the charge) that extracts real EM energy flow from the vacuum. That is extraordinarily simple and straightforward. Engineers and scientists have been using it for two centuries without understanding what they were doing. Every charge, dipole, charged capacitor, electret, and permanent magnet already continuously extracts EM energy from the vacuum. The two-fold  $COP > 1.0$  problem is in (i) *separately intercepting and catching (in an external circuit) some of the copious free flowing energy from the "extractor"*, and then (ii) *separately dissipating that collected energy in an external load without killing the "extractor" itself*— or at least only killing it more slowly than the load is powered. The most elegant way to violate the closed current loop circuit is with Kron's open path, typified by Tesla/Barrett potential energy shuttling. Since vector and tensor analysis will not even show it or model it, then a higher group symmetry electrodynamics is imperative in modeling  $COP > 1.0$  EM systems and their functions. Much of that work remains to be done.

Our main purpose in this chapter is to point out some selected efforts and approaches by scientists, engineers, and inventors. We will give a brief description and a few details, and leave it to the researcher for further experimentation and reflection. Hopefully, knowing what some others have tried and the results they achieved will prove helpful to the serious researcher.

We also strongly encourage the reader to again read this section after studying Chapter 9. In any  $COP > 1.0$  system, the excess energy must come from the "active environment". The active environment of an EM system consists of (i) the active vacuum and its interactions and dynamics, and (ii) the active local spacetime curvatures and their interactions and dynamics. Contrary to naive belief and the received view, overunity electrical power systems — particularly very high COP systems — are neither simple nor easy, but are extraordinarily difficult and highly nonlinear even when their appearance is deceptively simple. Chapter 9 will give a brief expose of some of the difficulties for higher COP systems. There we will refer again to the intricate circuit analysis work of Gabriel Kron {248}, to Dirac sea electron theory {249} both prior to observation and after observation, and

to the need for higher group symmetry  $O(3)$  electrodynamics by Evans {250} which is a subset {251} of the electromagnetics used in the unified field theory of Sachs {252}.

Chapter 9 indicates how mathematically complex these systems really are, even when they appear deceptively simple. The phenomenology is highly complex, and it has not yet been scientifically explored because of the erroneous received view that  $COP > 1.0$  EM systems are not permitted by Maxwell's theory or the laws of physics. That is a non sequitur. More exactly, *they are not permitted in that equilibrium class of Maxwellian systems described and selected by Lorentz's arbitrary symmetrizing of the Maxwell-Heaviside equations, following their previous symmetrizing by Ludwig Valentin Lorenz* {253}. Prior to applying the Lorenz-Lorentz symmetrical regauging, the Heaviside equations — which in field form are already a truncation to four vector equations of Maxwell's 20 quaternion-like equations — do prescribe both disequilibrium  $COP > 1.0$  and equilibrium  $COP < 1.0$  Maxwellian systems. The variables are not separated (potential formation) and the equations are difficult to solve, usually requiring numerical methods. With Heaviside's truncation and Lorenz-Lorentz regauging applied, the resulting "special case" equations — now for only that class of  $COP < 1.0$  Maxwellian systems that receive and use no net input from their active environment — continue to be used because closed analytical solutions can usually be had and numerical methods can be largely avoided.<sup>95</sup>

So with tongue in cheek, we humorously remark that  $COP > 1.0$  electrical power systems have not been developed or known because the early scientists were a bit lazy and wished to avoid ubiquitous use of numerical methods. These days, with computers, proper math programs, and sharp

<sup>95</sup> **For** some reason, electrodynamicists ignore the fact that the Lorenz regauging does assume two *additional* equal and opposite energy exchanges of the system with its external active environment, but carefully selected so that all the excess energy received in the system is purely in the form of a stress potential. Hence this energy continually does internal work on the system to produce additional stress, but cannot translate electrons through an external load to power it. Also, this regauging condition represents an effective rotation of the frame of the described system out of **the** laboratory frame. To then argue that this severely altered system (increased

stress, constant additional internal work being done on the system, frame rotation, altered potential energy) is the same system prior to Lorenz regauging, and that **such a** system is not receiving excess energy from its active vacuum environment, is naive in the extreme and a non sequitur.

graduate students to easily crunch the numbers, there is no longer any reason for continued arbitrary discard of Maxwellian  $COP > 1.0$  systems.

For such reasons, no legitimate theory of  $COP > 1.0$  EM power systems has been developed, except for light shed by Prigogine {254a-254f} and others {255a-255c} as to the necessary active environment, disequilibrium nature, and disequilibrium thermodynamics of  $COP > 1.0$  systems. Further, the energy flow theory (Poynting's theory) has not been further extended to include the Whittaker decompositions {243, 246} as should long ago have been done. Neither has it been extended to account for the arbitrarily discarded giant Heaviside nondiverged energy flow component.

The researcher should be aware that the energy input to a system is always in the voltage<sup>96</sup> (the *potential*; one input volt of potential will cause one joule of energy to be collected upon each interacting unit point electric charge in the system; one volt of drop in potential results when one joule of collected energy is dissipated per unit point collecting charge in the system.). The fields and their energy are functions of the potentials and their energy, not the other way round. After potentialization of the circuit, the subsequent movement of the potentialized Drude electrons, as current in the system, is connected with (and part of) the *dissipation* from the circuit of previously collected/intercepted energy from the vacuum.

## 4.2 Demonstration Gedanken Experiment

### 4.2.1 Work and Energy

Doing work is defined as *changing the form of energy*. No energy is lost per se when work is done; the energy is only changed from one form to

<sup>96</sup> The reason is that all 3-space EM energy — in the circuit or elsewhere — must come from the time domain to each 3-space point and return from that point to the time domain. The scalar potential (voltage) actually is an ongoing process whereby, for any interacting charge, energy in the time-domain and energy in 3-space are functionally combined in that 4-circulation at every point dipole in space. In quantum field theory, e.g. as shown by Mandl and Shaw {19}, the *combination* of the time-polarized photon and the longitudinal photon in 3-space is observed as the instantaneous scalar potential, but neither photon is *individually* observable. We comment that an "observable" 3-space potential is the result of an iterative set of  $d/dt$  differentiations of the ongoing "combination" of scalar (time-polarized) photons having their energy oscillations in the time domain, with longitudinal photons having their energy oscillations in 3-space along their line of motion. Hence each  $d/dt$  differentiation of the ongoing 4-space combination yields the instantaneous 3-space potential. Cumulating, one has the ordinary 3-space potential or "voltage" of macro electrodynamics.

another. All the energy since the beginning of the universe is still present,<sup>97</sup> and it is still repeatedly changing its form to do work, over and over. The point is, a single initial joule of energy can be "used" (changed in form) to do more than one joule of work, if multiple changes of form occur serially. *One joule of energy changing its form gives one joule of work, only if a single and total change of form of that joule of energy occurs and then no further change of form occurs.* If the joule changes form once, a joule of work is done and a joule of energy still remains in a second form. If this second form of the joule of energy is not lost, but is retained and then changed in form, a second joule of work is performed and there is still a joule of energy left in different form. And so on. Tricking a system to self-induce multiple iterative form changes of each joule of input energy (or at least of some fraction of each input joule), without losing the energy after each change of form, is one way of providing COP>1.0 in a system.

Remember that COP (coefficient of performance) is best defined as *the usable work output obtained, divided by the EM energy that the operator inputs.* Since "usable work output" is just usable "change of form of the energy", it can be seen that multiple changes of form of every joule of energy input by the operator can lead to COP>1.0.

This illustrates that one must be careful in applying the law of conservation of energy. For a thorough analysis, several features must be identified and accounted: (i) The flow of the energy impinging upon the collection, (ii) the collector itself and the type of collection process utilized, (iii) the linear or nonlinear operation of the collection/collecting process, (iv) the dissipation process used to dissipate the collecting mechanism, (v) what happens to the energy flow that was collected and then its collection "dissipated", (vi) what type of energy flow was collected, and then its collecting "dissipated", (vii) what happens to the collector after the dissipation interaction, (viii) what happens to the energy in different form after each previous change of form, (ix) whether single-pass or multiple-pass of the energy flow is used, (x) whether single collection or multiple collecting is used, and (xi) the effects of any nonsymmetrical regauging of a local component or region (e.g., as in simply

<sup>97</sup> However, "present" means in spacetime, not just in 3-space. The EM energy we think of as being in 3-space is macroscopically in continuous circulation from the time domain to 3-space and back to the time domain. Microscopically it is in *continual* circulation.



increasing one of the potentials of the region) that in turn acts as a free energy flow.

See again Figure 2-4 in Chapter 2. In general, the available energy flow surrounding a circuit will be far greater than the intercepted and collected energy in that circuit, particularly in a "single pass" collection — i.e., where the impinging energy only passes once. In analyzing a system or circuit, one must be very careful to ascertain whether the system utilizes any mechanisms to enhance and increase the energy collection fraction. If it does, then a necessary (but not sufficient) criterion for  $COP > 1.0$  has been identified in the system. Letokhov's negative absorption of the medium (i.e., excess energy emission) {256} and Bohren's experiment {257} are examples. Bohren's experiment is easily replicated by any nonlinear optics lab, and outputs 18 times as much energy as the conventionally calculated energy input.<sup>98</sup>

If the impinging Heaviside nondiverged component of the energy flow beyond the collecting/collector is rerouted and passed back to impinge again in the system — even on another collector or other collectors — this must also be taken into account.

Conventionally, the "magnitude" of the fields<sup>99</sup>  $E$  and  $H$  in the Poynting (collected) energy flow  $S = E \times H$  are "defined" by the collection from the fields by an assumed unit point static charge at each point in space. In short, the conventional fields have already been "defined" as a standard linear collection upon standard charged *mass*, *from the field entities as they*

<sup>98</sup> Energy conservation is not violated! Instead, the conventional calculation assumes a static intercepting unit point charge, which has the minimum reaction cross section in the stream of bidirectional longitudinal EM energy flows comprising the potential, etc. By placing the intercepting charged particles into particle resonance, the particles' reaction cross section is increased because each resonating charge sweeps out a greater geometrical cross sectional area. Hence the charges collect more energy from the energy flow comprising any "field" (actually field intensity) or "potential" (actually potential intensity) than is assumed in the standard input energy calculation. In short, Bohren's experiment takes advantage of that arbitrarily discarded Heaviside energy flow component that remains and is present but not considered in the conventional Poynting calculation and field intensity calculation. The experiment in fact proves the existence of the unaccounted but ubiquitous giant Heaviside nondiverged EM energy flow.

<sup>99</sup> At best, the 3-space point intensity of each 4-space field is so defined, for a forthcoming reaction with unit point static charge, and where the forthcoming reaction does not involve lingering time - charging but only simple time-excitation followed by full decay of the time-excitation via normal photon emission.

*exist in 4-space prior to interception and collection*, and where the collector itself is absolutely fixed and "static". So nonlinearity in energy flow collection — by additional disruption of the impinging energy flow induced by the dynamics of the collector itself— may easily increase the "reaction cross section" of the collector. The static reaction cross section of a unit point static coulomb and the dynamic reaction of a unit point resonant coulomb may differ appreciably.

Without stating it this clearly, Bohren has shown that the interaction cross section for a single-pass collection by one static particle may be increased by a factor of 18 in a given example, *by inducing resonance and thus increasing the "collection" dynamics of the collecting particle* in the impinging S-flow {257}. The work has been independently substantiated by Paul and Fischer {258}. It also is a direct proof of the existence of Heaviside's neglected nondivergent energy flow component surrounding every field and charge interaction.

So indeed there are COP>1.0 EM processes in the literature. The Heaviside component also pouring from the terminals of every generator and battery, already proves that *every generator and battery ever made already was and is a COP>1.0 energy transducer, because far more energy pours from the terminals of the generator and battery than the shaft energy input to the generator or the chemical energy dissipated in the battery.*

#### 4.2.2 Extending the Work-Energy Theorem

The standard work-energy theorem in mechanics may be conventionally stated as: *The change in the kinetic energy of a particle is equal to the net work done on the particle by the net force acting upon it.* As in any "model", here there are assumptions that are seldom taken into account. First, the collected/collecting kinetic energy of a particle is due to its increased interaction rate with the vacuum flux, because of its acceleration through that flux.<sup>100</sup> In mechanics the increase in flux interaction (and

<sup>100</sup> As we cover elsewhere in this book, any charge (which, together with its clustering virtual charges of opposite sign is a dipolarity) is a broken symmetry in the fierce flux of the vacuum. This means that every charge in the universe absorbs virtual energy from the vacuum, coherently integrates some of it into observable energy, and pours out that observable energy in all directions. The negative charge does that for positive energy; the positive charge does it for negative energy. The latter can be better interpreted as the return of positive observable energy from space to the positive charge, thence disintegration of that positive energy back to virtual energy, and subsequent re-radiation of that virtual energy back to the vacuum. One can in fact model the Bohren experiment in terms of the extra vacuum flux

hence "Newtonian 3rd law resistance" is just treated as a sort of resistance to acceleration, and known as *inertia*.<sup>101</sup> The actual energy of the vacuum flux interaction rate is a function of the square of the particle velocity through that flux — hence the formula  $K = 1/2 mv^2$  for the kinetic energy  $K$  of a mass  $m$  moving through the flux of space at velocity  $v$ . Relativistically, the mass of the particle is moving through the ambient potential flux, or we may view it from the particle's frame of reference where the ambient potential flux is moving through the particle but interacting with it. Only a single pass of the flux impinges upon the "particle collector", so there is only a "single-pass" type of energy collection ongoing.

All energy in the vacuum exists in "vacuum flux" or "change in vacuum flux" form. There is no force in the vacuum, although there is polarization that will produce a force upon a charge when one is introduced. The force occurs only after the "change in vacuum flux" that we call a field is interacting with a mass. The force is *already* a change to the mass, a priori, since mass is a part of force by  $F = d/dt (mv)$ . If energy is then added by a AK energy flux (usually mistakenly called a force) performing work upon mass  $m$ , this constitutes an additional energy flux or flow impinging on the

encountered and transduced by the resonant charge, as compared to flux encountered and transduced by the static charge. In the same vacuum flux density, a resonant charged particle will intercept and absorb more virtual photon energy than the same particle in static condition. Hence its broken symmetry will convert more absorbed virtual photon energy into real observable emitted photon energy.

<sup>101</sup> If one wishes to understand that inertial reaction, here is how it works. Consider the virtual charges of the vacuum as an analog to the Drude electron gas in a conductor. At the instant an observable charge starts to move, it is momentarily affecting all the surrounding virtual charges — an enormous number, which are initially repelling and attracting it in all directions intensely. To move, the observable particle must create a change in that entire participating virtual particle "gas". Just as the Drude electron gas, the vacuum "gas" of virtual charges has a certain relaxation time constant. So a finite time delay occurs before the vacuum gas relaxes and movement of the observable charge occurs. As the relaxation continues apace, the particle being acted on by a force accelerates. Even mass with a net charge of zero is filled with charges, and even the neutrons in the atoms are continuously changing into protons and back, etc. So all mass continually exists in the "charge and charge-changing" state. Inertia is in fact due to the relaxation time curve of the vacuum virtual charges "gas". We dealt crudely with this in Bearden, "Quiton/Perceptron Physics," NTIS Report AD-763-210, 1973, p. 11; hopefully a far better treatment will eventually be undertaken by qualified higher group symmetry electrodynamicists.

particle, imposing an additional "energy collecting" and gradient across the mass. Rigorously, the dynamic system comprised of the  $dK$  gradient coupled to the particle, and interacting with it, identically is a force.<sup>102</sup> Depending upon the situation, it may accelerate or decelerate the particle, or change its direction, or a combination. This is summarized in the usual work-energy formula

$$W = K_f - K_i = \Delta k \quad [4-1]$$

where the work  $W$  that was done is given by the change  $dK$  in kinetic energy of the particle from its initial kinetic energy  $K_i$  to its final kinetic energy  $K_f$ .

In applying the conservation of energy law, usually physicists utilize either the work-energy theorem or an approach closely paralleling it. This application is valid in any linear single-pass collection situation. It may not be valid — and usually isn't — for a multi-pass, multicollection system where the same energy, changed in form to accomplish work in a single reaction, is then changed in form iteratively, again and again, in the same system or material. In such case, one joule of input energy can and will

<sup>102</sup> We stress again that the hoary old mechanics, some four centuries old, is seriously in error in assuming a separate force acting on a separate mass. That remains an inexplicable non sequitur in modern physics, in its very foundations. We call attention to how classical electrodynamicists' wrestle with the problem. E.g., quoting Jackson, *Classical Electrodynamics*, 2nd edition, Wiley, 1975, p. 28: "...the thing that eventually gets measured is a force..." "At the moment, the electric field can be defined as the force per unit charge acting at a given point. It is a vector function of position, denoted by  $E$ ." Our comment is that the "definition" is in error, including the use of the word "field" for "field intensity", when field and its intensity are two entirely different things. A proper definition should be stated as "...the observable electric field intensity can be defined as the force per unit static charge and mass, existing at a given point in an interacting gradient of the virtual particle flux of the vacuum, as inferred from the changes induced upon the unit static charge and mass." The field intensity is a vector function of position, charged mass, and vacuum virtual particle flux gradient. The standard definition substitutes an effect (of collection) for a cause (prior to collection), and this error is widespread through physics, from mechanics to electrostatics and on into particle physics. On p. 249, Jackson shows how the electrodynamicists largely capitulate and continue to promulgate the substitution of effect for cause. Quoting: "Most classical electrodynamicists continue to adhere to the notion that the EM force field exists as such in the vacuum, but do admit that physically measurable quantities such as force somehow involve the product of charge and field." We comment that actually mass is a component of force, as shown by  $F = d/dt(mv)$ .

accomplish multiple joules of work in and on the system. So for our purposes we must modify the work-energy theorem to give

$$W = \lambda(K_f - K_i) = \Delta k \quad [4-2]$$

where  $\lambda$  is the averaged energy collection fraction, adjusted for multipass, multicollection and also for asymmetrical self-regauging (self-increase of the potential in, and hence the energy flow from, one or more regions of the active system's source). In formula 4-2,  $K_f$  and  $K_i$  and  $\Delta k$  still refer to single-pass collection only.

In the new work-energy theorem,  $\lambda = 1.0$  for that vast number of conventional cases that have successfully utilized the conventional form of the theorem. These are almost always single-pass, single collection systems. The new  $COP > 1.0$  systems have deliberately enhanced energy collection — and hence multiple *energy collection and work amplification*<sup>103</sup> — such as multi-pass collection. For these  $COP > 1.0$  systems, the expanded work-energy theorem form applies and in general  $\lambda > 1.0$ . In an ideal  $COP > 1.0$  system,  $\lambda \gg 1.0$ . In some versions of the Patterson Power Cell<sup>®</sup>, for example,  $\lambda = 1200$ . In the Sweet device (discussed later), a very high value of lambda resulted, so that  $\lambda = 1.5 \times 10^6$ . We sometimes refer to  $\lambda$  as the *energy amplification factor*, *energy collection fraction*, *Poynting amplification*, *collection amplification*, etc. Bohren and others have referred to it indirectly as the *interaction cross section*, the *resonance absorption cross section*, and the *negative absorption cross section*.

Again, we strongly iterate that *there is no conservation of work law in physics!* When energy is input to a system, acts on it, and is "dissipated" by a change of its form (doing work), the "dissipated" energy is still

<sup>103</sup> There is no "conservation of work" law in physics or thermodynamics. It is energy that must be conserved. A single change in form of K joules of energy gives an equal number of K joules of work done upon the interacting mass system. However, there remains an equal number of joules available, just in a different form. If that second K joules of energy is then changed in form again and not allowed to escape from the system, an additional K joules of work is performed in the system, without the operator having added any extra input energy. And so on, until the inefficiency of the system and some inevitable losses allow all the "recycling" energy to escape from the system. We strongly believe that ignition, quenching, and re-ignition phenomena such as in gamma ray bursters and x-ray bursters are due to exactly such processes where iterative change of form of each initial joule of energy occurs.

available after the work (change of the energy's form) is accomplished. However, usually by "dissipated" energy we mean energy that has permanently left the system (or a component in the system) and cannot be recovered and used by the system. The original input energy is not work, because it did not undergo any change of form prior to interaction with the system to change its form. So one does not do "work" as input, which is a non sequitur. Any work accomplished in the input section of a system is due to inefficiencies of the system,<sup>104, 105</sup> usually allowing extra change in form of some of the energy in non-useful processes called "input losses". As we stated, it is quite possible for a single joule of original input energy to perform many joules of work. During the subsequent billions of years following the formation of the observable universe and the energy in it, every joule of the primordial energy is still here. And every joule of it has been steadily performing joule after joule of work since then. Further, it has continually been recycled between 3-space and the time domain and back, and is continually being so recycled today.

Suppose input energy to a system has been dissipated (changed its form) once, doing work (single change of form of energy) in the system. If the dissipated energy in a different form is then recovered or partially recovered — without escaping the system — to change its form yet again in the system and produce additional useful work, that system is

<sup>104</sup> Almost always due to a negative feedback mechanism such as Newton's third law, self-regauging symmetry, the closed current loop circuit, inertia as due to a self-regauging 4-symmetry, etc.

<sup>105</sup> E.g., a transformer would be an overunity system, because the current in its primary is separate from the current in its secondary, if these two currents were completely decoupled and independent. In that case, the transformer would simply propagate and "couple" or pass energy emitted from primary to the receiving secondary, without back-coupling. However, the closed current loop in the secondary, routing all spent electrons in the secondary back through the back mmf of the secondary coil, produces a back-field coupling interaction with the primary, and this "back mmf/back emf" coupling requires energy dissipation in the primary section to overcome. In short, the transformer is designed so that the secondary lights the primary to a draw and the designer loses. With some losses and inefficiencies in the device, that makes the transformer a COP<1.0 device (unless free external energy is received in the input). The interested reader might extract several hints and suggestions in this book, passim, of things that overunity researchers have tried in their search to break up the back-coupling of a transformer. The simplest way, of course, would be to place a true negative resistor shunt across the secondary, so that part of the secondary current does not return back through the primary.

considered to be an open system far from single-dissipation equilibrium with its external environment.<sup>106</sup> In that case, instead of the first dissipation simply "returning" the energy to the external environment, the energy is recovered by another change in form (which may simply be a change in direction in the internal environment). The thermodynamics of an open system far from equilibrium with its active environment applies, whether that "environment" is internal or external to the system. It is "external" to the subcomponent of the system forcing the "local change of form" of the energy.

### 4.2.3 Gedanken Experiment: Multicollection by Regenerative Feedback

After a  $COP > 1.0$  collecting process with subsequent proper discharge of the energy, more work output as "dissipation of the collected-energy" exists than the energy being input by the operator or experimenter. By regenerative, clamped, carefully controlled positive feedback of a portion of the output *positive* energy<sup>107</sup> to the system input, the system can be converted to a self-powered (self-asymmetrically-regauging) system that powers both itself and its loads. However, see Chapter 9 for special considerations of the Dirac sea hole current and excess negative energy that arises for  $COP \gg 1.0$  EM systems. Positive clamped feedback will fail dramatically for any  $COP \gg 1.0$  EM system, and for many  $COP > 1.0$  systems it will also fail unless conversion of negative energy — arriving at the input section — to positive energy is accomplished.

To ease visualization of the energy multicollection process, consider a gedanken experiment iteratively retroreflecting a steady small EM energy input. Particularly see Figure 4-2.

<sup>106</sup>The vacuum environment is also "internally" penetrating throughout any macroscopic system, to the finest level! So the notion of separated "external" and "internal" environments requires strong qualification in any system engaged in iterative, work-amplifying interaction with its local vacuum.

<sup>107</sup>The output may contain appreciable negative energy as well as positive energy, however. In that case, in the feedback loop the negative energy must be transduced into positive energy by regauging, else it will appear in the input section of the system as an extra system load there in the input itself. It will "eat" incoming electrons from the external power supply, so that the external power supply has to power this "extra load" in the input section as well as powering the normal system load presented. This reduces the system COP to  $COP < 1.0$ .

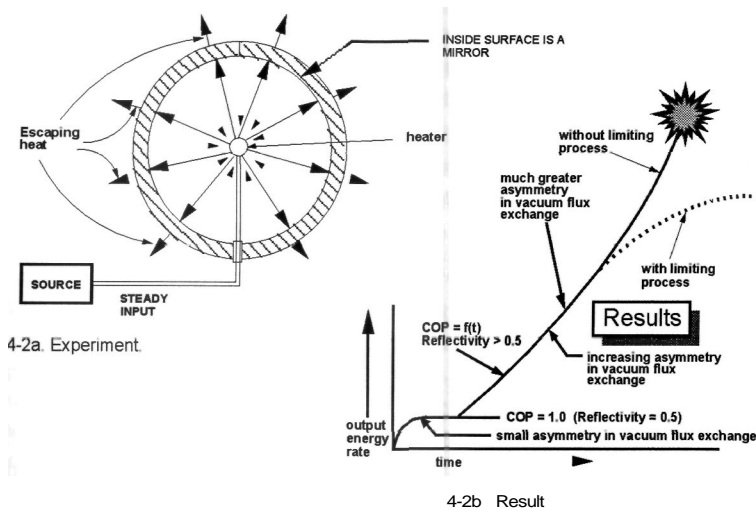

Figure 4-2 Heater wire in a hollow sphere with certain retroreflectivity properties.

As shown, a heater-emitter is placed inside a closed hollow sphere, through a tiny hole for the two wires connecting the heater wire into the external power supply (the external power supply is not shown). The heater emitter is 100% efficient; any joule of energy absorbed by it is re-radiated by it. One joule of energy (one watt of steady "input power" — conventional electrical engineering terminology where rate of work and rate of energy flow are confused!) is furnished from the power supply to the heater element inside the sphere. The inside of the sphere is coated with a substance that acts as a phase conjugate mirror (PCM) reflector with, say, 0.5 reflection coefficient. In other words, when scattered photons are emitted from the wire in all directions, they strike the inner surface of the sphere. Half are retroreflected precisely back to the spot on the resistor from whence they came, where they are absorbed and "recollected" to further heat the resistor, causing emission of additional photons from it. The other half of the absorbed photons on the inner surface of the sphere diffuse through the cylinder walls as heat, and escape as heat radiation from the sphere to the outside world.

If that sphere's operation could be maintained intact and stable, without change of the physical characteristics and mechanism, then the buildup of energy in the heater wire inside the cavity — and the buildup of the energy being emitted from the outside of the sphere — would be ever increasing. It would increase without bounds as time passed. Wait a short time, and



the sphere would be outputting 10 watts of power while one would still be inputting one watt. Later, the sphere would be outputting 1,000 watts of power, while one would still be inputting one watt. And so on. Indeed, the rise in energy density of the output would be asymptotic, and would increase toward infinity. The only limitation as to the energy output for a steady 1 joule per second input, would be the limit at which the mechanism goes unstable and changes occur to dampen and curtail the process.

Before the reader objects on conservation of energy grounds, one should realize that this rise in the energy density inside the sphere is an example of iterative regauging. The principle of *gauge freedom* — one of the axioms of quantum field theory and well established — assures us that *the potential energy of a system can be changed at will, and freely.*<sup>108</sup> What the gauge freedom principle does *not* state is a *mechanism for providing the additional potential energy and a source for it* — nor do the quantum field theorists and electrodynamicists. Without such a source and mechanism specified, the conventional gauge freedom principle assumes total violation of the conservation of energy law.

<sup>108</sup> Conventional scientists are almost always very careful to regauge symmetrically, so that the two excess force fields that result are equal and opposite, and sum to a net zero resultant field. That "zero-summed system" comprises a stress potential *a priori*. So such symmetrical regauging alters the stress in the system and alters its potential energy, but only in the form of additional stress energy. There is no *net* force and "force field energy" that can be used to dissipate that additional free stress energy in an external load, thereby doing free work. This regauging is a purely arbitrary practice by the electrodynamicists. We are far more interested in "asymmetrical regauging", where only one potential is freely changed or the two are changed unequally, resulting in a *net nonzero force field* that can then be dissipated in an external load to perform free work. Only by asymmetrically regauging an otherwise inert system can usable field energy be added and any work then be done by it anyway. In conventional systems, we do the "asymmetrical regauging" by adding the voltage (potential difference). As current flows with dissipation of energy from the circuit in the loads and losses, the system is able to develop "power" and thus do work in the external load. Unfortunately, the electrodynamicists are still obsessed with symmetry, so they ubiquitously employ in all electrical power systems the closed current loop circuit. This guarantees that the circuit will kill its source dipole (the source of the potential and potential energy generated from the virtual flux of the vacuum by the broken symmetry of the opposite charges of the dipole) faster than it powers its load. That way, lovely symmetry is maintained, beautiful free energy and negentropy are avoided and tossed away, and ugly pollution and destruction of the biosphere continues worldwide to fulfill the ever-increasing and insatiable thirst for electrical power.

In our supersystem view, the gauge freedom mechanism providing the energy is straightforward: the excess energy is freely supplied from disequilibrium in the active vacuum interaction with the system and in the disequilibrium represented by the local curved spacetime. Since a change in system potential energy is also a free change in spacetime curvature, then it follows that simply changing the potential energy of the local vacuum (the vacuum is also an electromagnetic system!) and of the local curvatures of spacetime is also "for free", or it can be. One does not have to perform work oneself upon spacetime to curve it! The mere *presence* of a spatial energy change — including a free potential energy change allowed by gauge freedom — is sufficient to freely curve spacetime also. That is a real energy change, because any curvature of spacetime acts back upon mass. Higher group symmetry electrodynamics does indeed include vacuum energy and energy current {259a-259c}, and it is possible to extract useful EM energy from the vacuum.

But back to our sphere, where the internal potential energy of the sphere is rising asymptotically without bound.

In the real world, of course, the reflection coefficients and the materials characteristics will change as the energy density changes, the sphere will heat, etc., and these changes will start damping the perfection of the retroreflection process to limit it to some finite plateau value which may be a  $COP > 1.0$  or  $COP \gg 1.0$  condition. Or, the materials will melt or soften so that the sphere ruptures and explodes, sharply quenching the process entirely and emitting a violent burst of energy to signal the disruption of the localization of the process.

Nonetheless, a successful real bench experiment similar to this should be possible with some tinkering, and it should readily yield  $COP > 1.0$ , after one waits for build-up and stabilization at some level. We would hope that a sharp young graduate student may eventually prepare a doctoral thesis on this experiment or a variant. The principle is demonstrable.

Similar buildups by regenerative feedback and multiple collections by the collectors do appear to occur in nature, up to and including such phenomena as gamma ray bursts, x-ray bursts, etc. These occur in some systems such as exploding gases (and in some cases, even in the upper atmosphere of the Earth). In such a system, the "physical particles in suspension in space" do move and continually disrupt the geometry for the increasing buildup, resulting in decay of the process after a time delay.

However, there is a finite time during which the movement of the particles is still insufficient to appreciably break the geometry and cause

quenching.<sup>109</sup> During this "nearly linear stage", the build-up applies and the energy density very rapidly increases. Build-up occurs and continues while the relaxation time of the initial countering symmetry-restoring mechanism for the old or former state or condition (the initial reaction) is occurring. A well-known conventional example is the Lenz law reaction. Then as the geometry changes significantly, a rapid damping of the energy density increase occurs, quenching the asymptotic rise and "discharging" or "decaying" back to a less-than maximum condition. However, the decay position or state (in the quenched condition) will be different from the initial condition before asymptotic rise (regauging) set in. The system usually will have itself absorbed and collected additional potential energy, and so it will be "hotter" or more energetic. This is often called the "afterglow". In the simple case, parts of the system will be in greater motion (more energetic).

An intermediate plateau can appear as quenching occurs and it can stabilize. However, if no stable plateau is reached during the damping, then further rapid quenching and a rapid reduction of the increased energy density occurs as the geometry changes become decisive and break the asymmetric self-regauging. Thus the "damping" of the process may yield a plateau of steady  $COP \gg 1.0$  operation, or it may simply go immediately into full catastrophic quenching and decline back to some lesser level of  $COP > 1.0$  operation, but still more energetic than the beginning condition. The latter case produces a sort of "afterglow" - - observed in the gamma ray bursters, e.g. — of increased energy density from the beginning of the quenched phenomenon. Indeed, in that new system of more energetic gases or particles, once the new state is stable, continuing regenerative feedback versus the new geometry can then reinitiate or "re-ignite" another "buster" followed by subsequent quenching. And so on.

We submit that the gamma ray bursters fit this schema and are consistent with it. So do the phenomena observed in intensely scattering photoactive media on the nonlinear optical laboratory bench. We hypothesize that the gamma ray burster and similar violent burst emission phenomena are generated by this mechanism or a similar version of it.

<sup>109</sup> Regardless of what we call it or what it has been conventionally named, any impulsive, explosive process involves at least momentary broken symmetry, resulting in instant and countering broken symmetry. Then a relaxation time passes, and the countering broken symmetry is dissipated by change of the system to a new potential energy state, the new dynamics state, etc.

Figure 4-3 diagrammatically shows a proposed range of such "excess energy" emissions due to this regenerative positive feedback and multiple collection mechanism. As can be seen, this may place our view of very powerful astrophysical emission phenomena in a completely different light, arranged energetically by the length of the initial "nearly linear" phase of exponential increase. There is a scale of stability levels up to just before the Big Bang itself [260]. A so-called Big Bang, of course, would result when the "containment" ability of 4-space itself is breached, resulting in a rupture of 4-space and a consequent violent blow-out into n-space (where  $n > 4$ ), with a very rapid "false vacuum" created *outside* the blow-out region and pumping itself up by asymmetrical self-regauging in a "new" 4-space. When a new stability level is reached outside the blowout hole from the spawning 4-space, it represents an outside "new" 4-space and a new, infant 4-spatial expanding 4-universe, freshly born.

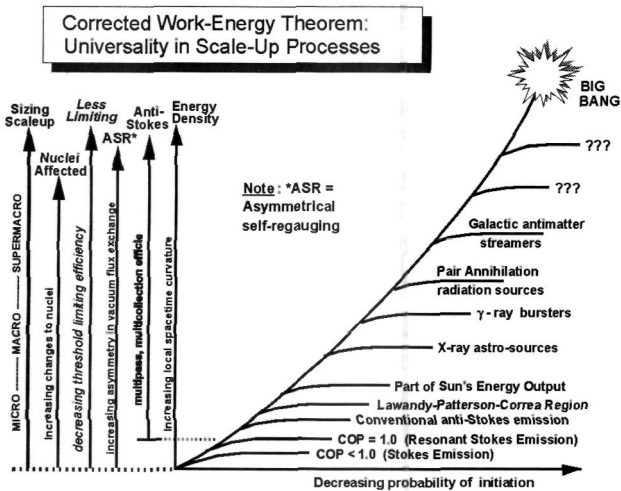

Figure 4-3 COP>1.0 stability levels for the asymmetrical self regauging process invoked by multipass and multicollecion of same energy.

So from inside the spawning universe, the burster phenomenon would be so great as to "burst" 4-space, producing a sort of "super black hole" as seen by the spawning universe. We hypothesize that the asymmetrical self-regauging mechanism produces a great burst of EM energy in its universe if a stability plateau is reached that is below the threshold of 4-space rupturing. If such a stability plateau is not reached, the asymptotic rise in local spatial energy density increases until the primary 4-space ruptures to

produce a "blowout" seen from the old universe as a sort of black hole. There is a sort of "white hole" in the new universe being spawned on the other side of the blowout. This white hole and its associated phenomena produce the birth of another 4-universe outside the original spawning 4-universe. At least we propose that as a hypothesis.

We propose that this could be a legitimate process for the birth of multiple 4-space universes in the infinite-dimensional cosmos.<sup>110</sup> It has an added advantage of accommodating the vexing question of "What existed before the beginning of time (in this universe)???" The answer then would be, "*The existence of time in another universe that birthed this one.*" We emphasize our interpretation of time as just a special form of EM energy, and not at all a "mysterious river down which we float helplessly as if in a drifting boat in the river's current."

### 4.3 Iterative Retroreflection and Collection in a Circuit

The normal circuit attached to a generator or other external power supply is the "external" portion of the overall closed current loop circuit passing back through, and including, the source dipole in the power supply. In a DC external circuit, we may consider that the energy flow pours forth steadily from the terminals of the generator (from the dipolarity between them) into space surrounding the external circuit. Since the external conductors act as a sort of guide, this *transmitted* external energy flow is generally parallel to the external conductors.

The external circuit further acts as a *receiver*. The surface charges and their fields intercept and interact with some of the transmitted energy flowing parallel to the conductors and outside them. This interaction diverts a component of that passing energy flow into the conductors, powering the Drude electrons. This powers the external circuit. The nondiverted component of the passing energy flow — usually much larger — escapes on out into space beyond the external circuit. According to Heaviside's energy flow theory {261}, this escaping nondiverged energy flow may be interpreted to exist in closed circulations.<sup>111</sup> Laithwaite

<sup>110</sup> After all, a "dimension" ultimately is just a fundamental variable in a physics model or, in other words, a "degree of freedom" in mathematical modeling. We may construct any number of dimensions we desire, merely by assigning a sufficient number of variables, including both overt variables and hidden variables, etc.

<sup>111</sup> We point out the interesting possibility of re-interpreting this "closed circulation" Heaviside component as the giant negentropic circulation of EM energy from the

{172b} has specifically commented upon the potential importance of this aspect of Heaviside's theory.

As we shall later address, Heaviside worked out but never published a draft theory of gravitational effects from this extra escaping energy flow {262}. Interestingly, since Lorentz's integration of the energy flow vector around a closed surface surrounding any volume element of interest, the discarding of this "excess nondiverged energy flow" has been ignored by electrodynamicists, and it has been ignored by gravitational theorists.

Consider a theoretically "perfect" generator, loss free. Consider the presence of the Heaviside nondiverged component emerging from the generator terminals — and filling all space around the external circuit. That is the part of the energy outside the circuit that is not caught and processed by the circuit, but is just wasted. By definition, in this "perfect" situation the magnitude of the Poynting or "caught" component of energy flow will precisely equal the magnitude of the mechanical energy input flow (rate) to the generator.<sup>112</sup>

But the presence of the additional huge Heaviside component rigorously means that far more energy pours from the terminals of every battery and generator than the amount of mechanical energy the operator inputs as shaft horsepower. This easily demonstrated fact — e.g., proven by the Bohren experiment {24} — continues to meet with a resounding silence from electrodynamicists and physicists, and particularly from those dogmatic skeptics so keen on defending the classical thermodynamics of closed or equilibrium systems as if they also applied to open systems far from equilibrium in their exchange with their active environment. We refer particularly to the dogmatists so supremely confident that  $COP > 1.0$  EM systems are prohibited by the laws of thermodynamics. These stalwart fellows would thus exclude every charge (and its associated fields and potentials) in the universe, were they logical and speaking scientifically. So they strangle at the gnat of  $COP = 4$ , and swallow  $COP = \infty$  while proclaiming that  $COP > 1.0$  EM systems cannot exist.

The dogmatists have achieved a major nefarious goal, however. They have silenced most inquiry into such matters by electrical engineering

time-domain to the negative charge, to 3-space, to the positive charge, and back to **the** lime-domain. To our knowledge, that has not been examined.

<sup>112</sup> That is merely a statement of the Lorentz symmetry condition self-enforced by the closed current loop circuit itself.

professors, young graduate students, and young postdoctoral scientists. They have glorified classical equilibrium thermodynamics into a religion rather than the partial and imperfect model it really is. They are directly responsible for the continuing rape and pillaging of the planet's resources, pollution of the biosphere, global warming, and the increasing death of species. They are indirectly responsible for the deaths of more human beings than Hitler, Mao, and Stalin combined. Most of the blame for environmental pollution problems concerned with power and electricity is squarely at their feet. Sadly, the environmentalists seeking to save this planet and biosphere have not yet recognized the true nature of the scientific Taliban that has generated the environmental problem. In tolerating its own scientific "terrorism", the scientific community seriously aborts much of the scientific method.

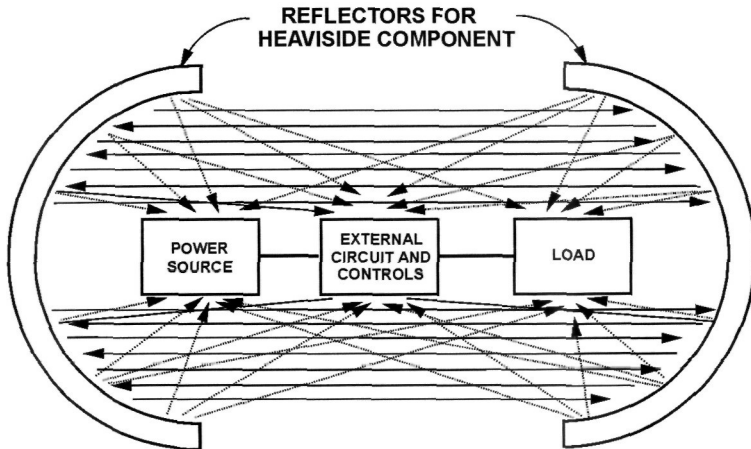

Figure 4-4 Iterative retroreflection of the "passed" Heaviside component back and forth across a circuit -- thematic.

See Figure 4-4. The neglected large nondiverged energy flow component need not be wasted. As an example, part of it can be captured and used, by applying near-field antenna techniques and such methods as Bohren's resonance increase of the intercepting charge's reaction cross section.<sup>113</sup> It is possible to intercept part of that excess energy that is there and available. E.g., even after it passes on by the immediate circuit, the Heaviside energy flow component can be intercepted beyond the circuit

<sup>113</sup> Or other methods we cannot yet divulge because of patent situation.

and retroreflected back across the same circuit again. In this way — at least in theory — extra Poynting energy can be collected and recollectd by the same external circuit for a single given input energy.

In essence, such an "iterative, multi-collecting circuit" is now fed with transmitted energy from multiple (iterative) paths simultaneously. This is *physically doable*,<sup>114</sup> but it is not a simple procedure, and antenna theory and especially near-field antenna theory must be utilized as well as focused retroreflection techniques. To directly model it, higher group symmetry electrodynamics (such as quaternion EM, O(3) EM, etc.) must be used. Precisely such phenomena are met in modern experiments in intensely scattering optical materials {263a-263b, 264a-264b} and in Bohren-type experiments where more energy is collected than the operator has input via standard calculations {257, 258}.

## 4.4 Tesla's Iterative Retroreflection Work

### 4.4.1 Tesla's Single Wire Circuit

See Figure 4-5, which diagrammatically shows one of Tesla's developments, which used a retroreflective single wire circuit between two large separated capacitances. This was the basic approach used in his magnifying transmitter and in several other circuits. Here the dipolarity exists between two accumulators, one at each end of a long conductive path with a load in the middle. AC operation is used, by setting up oscillation end-to-end along the "single wire" circuit, from accumulator to accumulator. Even so, no overunity operation will be experienced unless passive retroreflection of the normally wasted Heaviside component of each energy flow "passage" occurs back from each receiving end, so to speak {265}. That is possible if specialized dielectric material and construction is used in the end capacitors.

<sup>114</sup>E.g., some of Tesla's actual patented circuits do it, but that part of their **functioning** is not described by any vector or tensor analysis. However, a higher **group** symmetry electrodynamics analysis of the circuits will indeed show the effect clearly as a "shuttling" of potential (regauging) around the circuit at will. E.g., see T. W. Barrett, {124, 286a, 286b}.



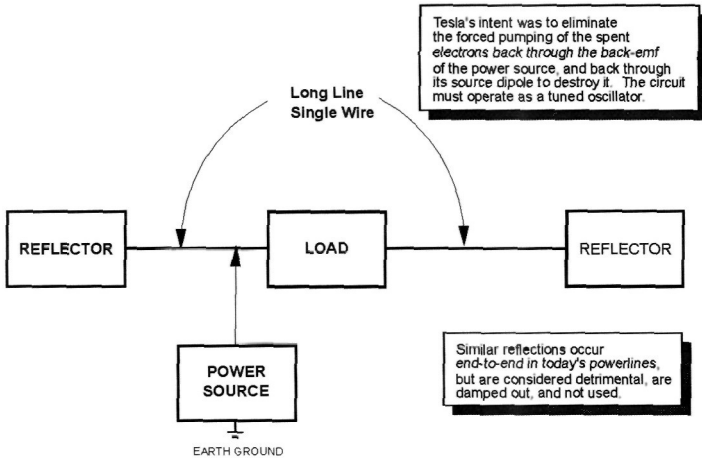

Figure 4 5 Tesla's iteratively retroreflective single wire circuit.

Further, it may usually be necessary to place the individual charges comprising the "current surging to and fro" into particle resonance at either the frequency being transmitted or some subharmonic of it. This schema is doable, but it is difficult and most everything affects it, including even the impurities in the conductors.

#### 4.4.2 Strain to Stress Potential Energy Transduction

See Figure 4-6. This is a diagrammatic representation of a fundamental "strain-to-stress" transduction mechanism we believe was involved in Tesla's "single wire circuit" (i.e., his iterative retroreflecting circuit).

At each end of the circuit, the electrons are "trapped" in the open outside end. Hence when EM energy rushes to the capacitor on one end of the circuit, the forward emf tries to strain the dielectric from the inner plate toward the outer plate. However, the trapped electrons in the outer open wire cannot move, so they produce an equal back-emf and back force trying to strain the dielectric from the outer plate to the inner plate. The result is that the translational field "strain" energy (dipolar charging) is transduced into stress potential (monopolar charging) energy. Electrons try to strain the dielectric from the inner plate toward the outside with a "forward emf so as to charge the capacitor normally, while the trapped external electrons simply push back the other way, exerting a back emf force that is equal and opposite to the straining force from the forward emf and simultaneously tries to "charge" the capacitor in the opposite direction.

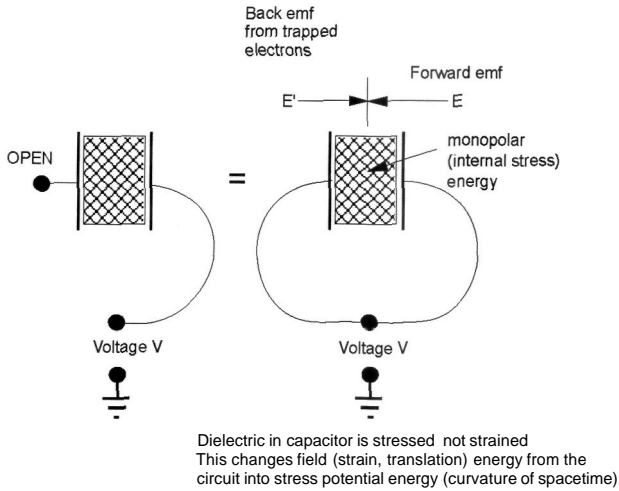

Figure 4-6 Transaction of translational field energy into stress potential energy.

Here is the importance of the "vector zero resultant" stress (monopolar) charging that occurs: The input EM strain field energy familiar in dipolar charging of a capacitor is converted to a dielectric stress (monopolar) potential for monopolar charging. This changes *translational* field energy (external energy) into *stress potential* energy (internal energy), adding an equal amount of back-emf translational field energy in so doing. In short, the charging captures an equal amount of charging energy from its external environment — in this case, from the back emf of the trapped external electrons in the outside open wire. This is one way to capture and use the back emf energy normally reducing the energy available.

We point out that this is charging the capacitor by *Lorentz's symmetrical re-gauging*, and it represents a rotation of the frame of the capacitor itself out of the laboratory frame. As is well known, the trapped energy of a capacitor in a rotated frame is not the same as the energy of the same capacitor in the nonrotated lab frame.

**The** single-wire system destroys the symmetry-enforcing function of a closed-current-loop circuit conventionally used. In short, it does not return **the** "spent electrons" from the ground return line back through the source dipole of the outside power source, so it does not use half the collected energy in the circuit to destroy the source dipole and its extraction of EM **energy** from the vacuum (to destroy its broken symmetry). Because it

retains the broken symmetry, Tesla's single wire system is an open system far from thermodynamic equilibrium with its active vacuum environment. It is thus permitted to exhibit those five magic functions of such open dissipative systems: (1) self-ordering, (2) self oscillation or self-rotation, (3) outputting more energy than the operator inputs, (4) self-powering of itself and its load, and (5) exhibiting negentropy.

#### 4.4.3 Potential Energy Shuttling in a Circuit

The net result is to "shuttle" the (stress) potential energy back and forth in the circuit, between the ends. See Figure 4-7. When this stress potential energy shuttling is done at the natural (or tuned) resonant frequency of that single wire circuit as an oscillator, the monopolar charge transfer is optimized and amplified by the resonance effect, with an increase in the energy being shuttled. It is this type of Tesla single wire circuit that can in theory exhibit  $COP > 1.0$ .

Tesla's single wire system also forces the change of energy between internal energy and external energy. A deeper analysis will also involve Dirac sea hole current effects as well as lifting of electrons from the Dirac Sea and combination of unobservable Dirac sea holes and electrons without radiation. However, we leave that for the advanced theorists. A taste of it is included in Chapter 9.

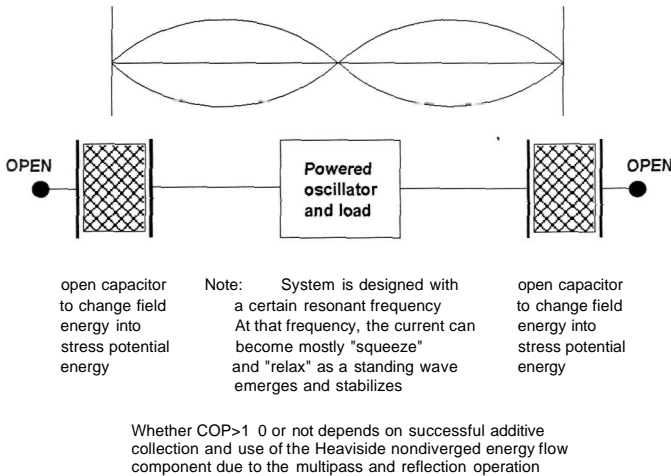

Figure 4-7 Tesla's resonant single wire circuit operation.

But is there any evidence for this "shuttling" of the monopolar potential in Tesla's circuits? Yes, there is, and indeed some of Tesla's patented circuits

do exhibit such energy shuttling in them, as rigorously shown by Barrett {124, 286a, 286b}.

#### 4.4.4 Other Considerations

For  $COP \gg 1.0$  systems and some  $COP > 1.0$  systems, the concepts of Chapter 9 must also be applied, since the system outputs not only positive energy but also negative energy. The negative energy — in the form of Dirac sea hole current — then sweeps back through the system from its output section to its input section. At various places, these "vacuum holes" eat electrons (as on atoms, causing ionization).<sup>115</sup> In short, the Dirac sea holes are converted to more normal lattice holes, and thus can be dealt with in the same fashion as semiconductor designers handle lattice hole problems inside their semiconductor designs. Positron (hole) effects are well known in materials science, and are increasingly being used in actual systems such as the antimatter (positron beam) microscope {266a-266b}.

We accent that a simple LC oscillating circuit does not produce  $COP > 1.0$  of itself. If, however, the charges in the currents surging to and fro are in particle resonance at the "feed frequency", then they will "sweep out" a greater geometrical cross sectional area to intercept additional Heaviside energy flow existing outside the normal "static charge" Poynting energy flow. This is similar to the "intercepting resonant particles" process utilized by Bohren {257}, and it allows output of more EM energy than the operator inputs *in the calculated Poynting component* of his own input energy flow. It *does not* output more EM energy than the operator inputs in the sum of his Poynting input component and his Heaviside input component.

The real energy conservation law is that the input energy from all sources and of all types must equal the output energy of all types, where by

<sup>115</sup> The union of a Dirac hole (4-space negative energy electron before observation) and a positive energy electron before observation, can occur without radiation. The two curvatures of spacetime involved are equal and opposite, so they just get **replaced** by a flat spacetime, which involves a filled Dirac sea (all the holes filled with electrons). In short, the energy can go into changing the stationary local double **recurvature** of local spacetime, by a sort of "superposition of two spacetime curvatures", to give a net flat spacetime, rather than dynamically radiating EM energy away at the speed of light. However, if either of the two interacting particles has been observed, this is not the case and standard pair annihilation will be observed. The point is that particles in their unobserved *mt* state rather than their observed *m* state, can interact without observation, similar to the way that wave-to-wave interaction occurs in nonlinear optics.

"output" we mean output as useful energy and output as loss or non-useful energy.

So conservation of energy flow is not violated, because one also inputs an additional *Heaviside nondiverged* component, unknown to Bohren. Circa the 1880s or early 1890s, Lorentz arbitrarily discarded it from accountability. One does not have to "pay" for that *nondiverged* and *unaccounted* input energy flow component. Except in continually applying Lorentz's integration trick to discard it, the *nondiverged Heaviside* component has been almost totally neglected in the textbooks since Lorentz arbitrarily discarded it back there circa the late 1880s. However, it is roughly dealt with in near field antenna theory, sometimes under the topic of "Poynting energy bunching". In the near field, e.g., there also may be a substantial *longitudinal* E-field component. One region may be oscillating back and forth along the flow direction, while the region in quadrature may be flowing in only one direction.

By causing the intercepting charges themselves to resonate and sweep out a greater reaction cross section in an energy flow, the normal definitions of "field intensity" and "potential intensity" are no longer true, because their reaction intensity to a unit point *static* charge has been used as their stated "magnitude". The conventional definition is only for an indication of the *intensity* of the energy flows comprising the field and potential. With the unit point *resonant* intercepting charge rather than the assumed *static* charge, the reaction cross section for the same charge increases, and so the "apparent magnitude of the (intercepted) field intensity" also increases beyond what is in the textbook. So far as I am aware, there is no previous precise term associated with this phenomenon, except to lump it in the euphemism of "negative absorption of the medium" or "negative resonance absorption of the medium" in certain materials {267}. It is more nearly a Poynting energy amplification process, since the "intercepted" or Poynting component of the energy flow is increased. Thus it can be a mechanism for  $COP > 1.0$ , if the closed current loop circuit's use of half the collected energy in the circuit to kill the source dipole is also defeated.

Nonetheless, energy bunching or Poynting component amplification by altering the reaction cross section function of the intercepting particle is a legitimate way to provide excess "free" energy input for  $COP > 1.0$  EM power systems.

## 4.5 Perspective on Tesla vs. Marconi

Tesla was neither deluded nor mistaken, though some electrodynamicists have mistakenly considered him in that light. On the other hand, Jackson — one of the leading electrodynamicists of our time — pays Tesla a significant compliment as follows {268}.

*"In U.S. patent no. 787,412 (April 18, 1905), reprinted in Nikola Tesla, Lectures and Patents and Articles. Nikola Tesla Museum, Beograd, Yugoslavia (1956), this remarkable genius clearly outlines the idea of the earth as a resonating circuit (he did not know of the ionosphere), estimates the lowest resonant frequency as 6 Hz (close to the 6.6 Hz for a perfectly conducting sphere), and describes generation and detection of these low-frequency waves. I thank V. L. Fitch for this fascinating piece of history."*

We also point out that many present science texts err by continuing to credit Marconi with the *discovery* of radio, although he certainly did much to pioneer it and received a Nobel Prize in 1909. Hertz must be given credit for the first deliberate signal transmission per se, during the period 1886-1888. As his transmitting antenna, Hertz used an end-loaded dipole with a gap, and as his receiver he used a resonant square loop antenna with a gap {269}. Sparks produced at the gap in his transmission antenna resulted in sparks appearing at the gap in his receiving antenna.

Marconi became obsessed with Hertz's results nearly a decade later, and in mid-December 1901 Marconi announced the reception of signals at St. John's, Newfoundland that were transmitted across the Atlantic from Cornwall, England. He later recorded radio signals transmitted around the Earth, and began regular trans-Atlantic message service in 1903.

Marconi's patent {270}, however, was eventually overturned by U.S. Supreme Court decision {271}, because Tesla's patents (and demonstrations) substantially preceded it. Tesla also demonstrated radio transmission before Marconi, and Marconi actually used a modified Tesla circuit in his famed transmission in 1901. Nonetheless, this is not to detract from Marconi's accomplishments; he definitely put "wireless communications" on the map. It is simply to give *discoverer of radio* credit where credit is due.

Tesla was also closer to the truth of the form of an EM wave in space than are modern electrical engineering and most electrodynamics texts. In the present book we have stated that what exists in 3-space as the so-called "transverse EM wave" are actually longitudinal EM waves and functions

of them, with the energy entering each 3-space point from the accompanying time-polarized (conjugate) EM wave at that point (i.e., from the time domain) and emerging in 3-space in the form of a longitudinal EM wave, in 1:1 correspondence.<sup>116</sup> This is followed by a return of the energy from 3-space back to the time domain. This "circulation" from the time domain to 3-space and back to the time domain occurs at every point dipole in 3-space. Only the presence and combination of both the time-polarized photon and the longitudinal photon at each point in an EM wave makes the wave "observable", when we translate into wave phenomena the photon phenomena pointed out by Mandl and Shaw {19}. What spreads as EM energy flow in space (from a source charge) is the local polarization of the vacuum, associated with this giant negentropy circulation from time to the negative charge, to the positive charge, and back to time.

The notion of the transverse EM wave flowing through space is an artifact of the ubiquitous *substitution of the effect for the cause* in Maxwellian electrodynamics. E.g., a completely erroneous "definition" of the causal field (as it exists in space prior to interaction with charged mass) is given as the *effect of its interaction with a ubiquitously assumed unit point charge at every point in space where the field is present*. This in fact substitutes the effect (existing *after* the interaction) for the cause existing *prior to* the interaction. That of course is a gross non sequitur.

We give a concrete example from the first edition of a standard dictionary of physics and mathematics {272}:

*"electric field... 1. one of the fundamental fields in nature, causing a charged body to be attracted to or repelled by other charged bodies; associated with an electromagnetic wave or a changing magnetic field. 2. Specifically, the electric force per unit test charge."*

<sup>116</sup> Later we shall deal a little further with how EM energy iteratively recurs statically in 3-space and propagates dynamically and continuously in 4-space, in more detail. The solution to the long-vexing particle-wave duality is the process of observation. Before observation, an entity is dynamic and continuous in spacetime, not 3-space. After observation (by emission of a photon), it is a momentary frozen 3-snapshot (particle) at a single instant of time. At the next immediate instant, a photon is absorbed, reconverting the "static snapshot" into a dynamic 4-entity again. Since observation (photon emission) and de-observation (photon absorption) iterates at extremely high rate, the entity and each tiniest part of it oscillate back and forth between being a frozen 3-entity (particle) and a dynamic 4-entity (wave).

In the first definition, the field is given as the "cause" of the interaction that exists between like and unlike charges. In the second definition, the field is given as the effect — of the interaction with a test charge — of *something undefined* as the cause.

An entirely different "definition" is given by Gray and Isaacs {273}:

*"electric field ... The space surrounding an electric charge within which it is capable of exerting a perceptible force on another electric charge."*

Here it is defined as simply the space around an electric charge, and not really the cause or effect of anything, unless that local spacetime has been curved (which it has).

Not to belabor the point, this sort of thing led Feynman to "define" the EM field in this fashion {274}:

*"...the existence of the positive charge, in some sense, distorts, or creates a "**condition**" in space, so that when we put the negative charge in, it feels a force. This potentiality for producing a force is called an electric field. "*

So Feynman made the electric field a *condition in space* surrounding a charge, where the condition can produce (has a potentiality for producing) a force on another charge. He also was aware that force is an effect of the reaction of the causal field with charged mass, in the following statement {275}:

*"...in dealing with force the tacit assumption is always made that the force is equal to zero unless some physical body is present... One of the most important characteristics of force is that it has a material origin..."*

In Maxwell's theory, the electron, atom, and nucleus had not yet been discovered, and electricity was considered a thin material fluid, flowing in a wire (hence the name "currents") much like water through a pipe. The surrounding space was considered filled with a thin material fluid called the luminiferous ether. A very rough notion existed that the "shaking" of the ether disturbance coming in to an antenna would disturb or perturb the electric fluid in the wire directly. Hence, if one "measured" a transverse oscillation of the electric fluid in the wire due to this "detection", it conclusively "proved" that the incoming ether-perturbations were also transverse. On that notion — together with Faraday's notion that "field lines" were taut physical strings, so that "field perturbations" were naught



but plucked oscillations of these taut strings — the entire notion of the transverse EM force field wave in space was created.

It really is not that way, as is easily shown with modern re-examination of what happens in the receiving wire, considering the Drude electron gas {276} and electron drift velocity. Today we know that the electrons move *longitudinally* down the wire only with a small drift velocity (usually a few inches per hour), while the signal (field) races longitudinally down the wire at essentially light speed or nearly so.

The electrons are longitudinally constrained in the wire because of the vast number of electrons ahead of them that tend to repel their longitudinal movement. The electrons are far less constrained laterally in the wire. However, each electron is also spinning, and its 3-space performance may be compared to a spinning gyro, whose spin axes are now longitudinal restrained. Accordingly, the electrons readily *precess laterally* in the wire<sup>117</sup> when perturbed *longitudinally* by the incoming longitudinal 3-space components of the "wave in vacuum" — by gyroscope precession theory. The electrons at the surface layer of the wire are somewhat less constrained longitudinally, and they "slip" a little down the wire in each oscillation, accounting for the very slow electron longitudinal drift velocity.

Accordingly, one of the most important dynamics of the circuit is the dynamics of the surface charges, as pointed out by electrodynamicists {277}.

If the incoming waves were true lateral waves, there would be no longitudinal force component on the laterally precessing electrons, and coherent current would not flow longitudinally in the wire at all. Instead, one would just get some longitudinal to and fro noise in the coherent lateral motions of the electrons, due to electron collisions.

<sup>117</sup> It is this lateral precession movement of the electrons that is "detected" in most of our instruments. To the early electrodynamicists prior to the discovery of the electron, this detected lateral motion was considered the "shaking of the material electric fluid" in the detecting wire. It was thought that the incoming "electric fluid" from space also had to be material (in the material ether) and transverse, because otherwise the oscillations from space could not have mechanically transferred their "lateral oscillation" to the electric fluid in the wire. Faraday's "material lines of force" concept and the notion that EM disturbances (waves) were simply the mechanical pluckings of these taut strings which also involved similar "material ether" concepts.

Nonetheless, it seems we are stuck with the ubiquitous transverse EM wave model. For more than 100 years, scientists have universally substituted effect for cause in the case of much of electrodynamics — as in the continuing substitution of what is *diverged from* the field and potential at each point in them, by an assumed static point charge, as being the magnitude of the field or potential itself at that point. At best, what is diverged from the field or potential is an indication of the point intensity of the energy flows comprising the field or potential at each point, and in the case of the field, of the prevailing direction.

So electrodynamics is still riddled with that nearly all-pervasive error, and it seems it will likely never be corrected. The leaders of the scientific community do not seem to wish it done and will not allow it to be funded. In short, the community is so comfortable with that grave error that it will almost defend it to the death. The so-called transverse EM wave in 3-space has come to be accepted as if it were a law of nature.

Occasionally a journal will point out the terrible non sequitur in the prevailing notion of the EM wave in space as a "plane wave of oscillating orthogonal E and H fields along the x- and y- axes moving at light speed in the z- axis direction." Romer, former editor of *American Journal of Physics*, provides a prime example {278}. Romer takes to task:

*"...that dreadful diagram purporting to show the electric and magnetic fields of a plane wave, as a function of position (and/or time?) that besmirch the pages of almost every introductory book. ...it is a horrible diagram. 'Misleading' would be too kind a word; 'wrong' is more accurate. " "...perhaps then, for historical interest, [we should] find out how that diagram came to contaminate our literature in the first place. "*

At any rate, once we understand how the real EM wave exists in space, then we can sympathize with Tesla's view of it from the following {279}:

*"Tesla upholds the startling theory formulated by him long ago, that the radio transmitters as now used, do not emit Hertz waves, as commonly believed, but waves of sound... He says that a Hertz wave can only be possible in a solid ether, but he has demonstrated already in 1897 that the ether is a gas, which can only transmit waves of sound; that is such as are propagated by alternate compressions and rarefactions of the medium in which transverse waves are absolutely impossible. "*

In Tesla's own words {280}:

*"...I showed that the universal medium is a gaseous body in which only longitudinal pulses can be propagated, involving alternating compressions and expansions similar to those produced by sound waves in the air. Thus, a wireless transmitter does not emit Hertz waves which are a myth, but sound waves in the ether, behaving in every respect like those in the air, except that, owing to the great elastic force and extremely small density of the medium, their speed is that of light."*

From quantum field theory, the instantaneous scalar potential in space is actually a coupling of a scalar photon and a longitudinal photon {19}. The only EM component in 3-space is that longitudinal photon.<sup>118</sup>

Transforming to wave language, Tesla appears to have been correct in his view of the longitudinal form of the EM wave in 3-space, whereas all the texts are still wrong even today.<sup>119</sup> However, Tesla was also noted for grandiose pronouncements, a trait which certainly did not endear him to the struggling electrodynamicists of the time, even when he was correct and they were wrong. An example is the following {281}:

*"The Hertz wave theory of wireless transmission may be kept up for a while, but I do not hesitate to say that in a short time it will be recognized as one of the most remarkable and inexplicable aberrations of the scientific mind which has ever been recorded in history."*

Unfortunately, in electrodynamics we are still stuck with that "most remarkable and inexplicable aberration" today, and we will remain stuck with it until the leaders of the scientific community (such as the National Academy of Sciences and National Science Foundation) recognize it and fund a complete overhaul of the foundations of classical electrodynamics, which is so sorely needed. On the other hand, *one should not hold one's breath while waiting for the mountain to come to Muhammad! One might as well ask the stars to fall from the sky as to ask the leaders of the scientific community to correct the serious foundations errors in physics and especially in electrodynamics.*

<sup>118</sup> Hence it is not surprising that all EM in 3-space decomposes into bundles of longitudinal EM waves and their dynamics, as shown by Whittaker {85, 91b}.

<sup>119</sup> However, Tesla did not appear to realize the involvement of time-energy transduction to longitudinal KM 3-space wave energy and vice versa.

## 4.6 Conclusion

Hopefully we have set the stage for our next chapter, where we will be advancing mechanisms and approaches that have been tried by a variety of researchers. Several of these researchers have indeed produced COP>1.0 devices and processes. However, at this writing none of the devices produced by these inventors and researchers are in production and on the market. As we mentioned in Chapters 1 and 2, there are very powerful forces that have been applied to prevent such development.

Briefly, such suppression has resulted due to one or more of the following:

- (a) Sheer greed by the group that gathers around the inventor/researcher, including multiple competing investors and/or "backers". Often a struggle for control develops, and the project is decimated in the process. In many cases a legal struggle also develops, with the result that the legal status of the invention may be fouled beyond repair.
- (b) Naivete on the part of the inventor and his surrounding group. The inventor needs the frequent advice of a patent attorney, a regular corporate attorney, a person familiar with research and development projects and procedures, a person expert in testing (particularly with sophisticated multichannel digital oscilloscopes which gather multiple channels of data simultaneously and integrate under the curve, an accountant, and a person skilled in negotiation with potential investors and backers. Most inventors do not have access to all that, or only have access to it after much of the die has been cast and serious mistakes have been made.
- (c) Animosity and fierce attack from the scientific community and self-appointed "defenders of the faith". Few inventors are prepared for the onslaught that awaits them if they succeed in producing a genuine COP>1.0 electrical system. Slander and libel are just part of it. An inventor or researcher caught up in always trying to defend himself against vicious ad hominem attack is an inventor successfully deviated from his work. The family also often suffers.
- (d) Just now, after the Enron fiasco much of America is becoming aware that powerful organizations often pull out all the stops in a blind pursuit for money and power. Of course they have done so for a very long time; this is nothing new. The inexperienced inventor or researcher is ill prepared for the fact that portions of

government organizations,<sup>120</sup> national labs, universities, etc. may be precisely that way also! U.S. government laboratories also file patents; check it out! Check out Fullerton's defense of his patent rights for his ultrawideband communication system work.

The people in any large organization form a bell-shaped distribution curve. About 9% of that curve represents folks who have — to put it mildly — little ethics when it comes to position, power, and money. Some of these 9% fellows will go to quite some length to twist the patent or part of it or control of it away from an inventor. An inventor who has never heard of "march-in" rights (a neat little "theft" phrase favored by DARPA, for example) is often an easy mark. Government agencies will be on an interesting invention and its hapless naive inventor like vultures on a fat calf. They dangle some money and a contract to "assist the inventor to get his invention developed". There is a little clause in the fine print of the contract where the government reserves "march-in" rights. This is a hidden bombshell that really says the government — *anytime it wishes* — can just unilaterally declare that the funded inventor isn't getting the invention to market fast enough, so a single bureaucrat just *seizes it* — in the name of the government, of course. Anyone who has been in serious aerospace contracting very long is also aware of the deals between a few government fellows who control award of the funds, and their "favored contractor". If enough business is steered to the contractor by the government person, it is implicitly understood that when the government fellow retires, he goes to work for that company with a Vice President position, lucrative salary, and a fat stock option. It's easy to become an instant millionaire or multimillionaire that way. A small percentage of government contracts are actually contaminated in such a hidden fashion. The universities usually are much more open and blatant, and just put

<sup>120</sup> Interestingly, the government is not allowed to copyright its own publications by federal servants. Neither should the government be allowed to patent its own inventions by federal servants and federal agencies. This has set up direct conflict in the federal funding channels for the taxpayers' funds intended for independent research, providing a wonderful opportunity for hanky panky by that lower 9% of the people comprising any large group. By the bell-shaped distribution curve, those comprising that 9% will rise to the opportunity. They are manipulative, greedy, and some are immoral and self-serving. Partially coupled with a similar low "bad apple percentage" in the contracting game, this enables many travesties in the name of federal research and development with respect to patents and misdirection of funds.

in a clause that says, "All patents revert to the university!" Also, the inventor must be aware of the difference between "nondisclosure" and "non-circumvention". Just try getting the latter clause from a university, or either clause from a government agency (yes there are rules for "proprietary information", and they are widely violated). Non-circumvention means the outfit agrees not to change a coil or something, and go and patent your invention. Nondisclosure means they just agree not to talk or write about it openly.

- (e) And yes, in addition to these many "petty" little conspiracies, there really is a *great* conspiracy — in fact, there are many of them. Churchill just referred to the entire set of conspiring cartels as the "High Cabal". This is a loose-knit set of extraordinarily wealthy cartels that between them control much of the financial power of the world. You can only find the principals behind a couple of hundred interlocking corporations, if you penetrate deeply enough. Much of their great financial income comes from the control of energy at its various levels, through a net of interlocking corporations. Something like \$2 trillion dollars per year is their "take" from energy worldwide. Oil plays a great role in that. These "high cabal" fellows make or break nations financially, as is almost being done to Argentina as this is being written. They also have been stopping COP>1.0 electrical power systems since shortly after the turn of the century, using whatever means are necessary — fair or foul. That is why we still are burning oil, coal, and natural gas, and why our automobiles and trucks run off gasoline and diesel, and not off free electrical energy from the vacuum. The high cabal intends to keep it that way. Some of the major primary means of "stopping" an invention have been as follows:
- a. Manipulation and improper use of the law (Gray's production line was shut down by law officers before his engines could roll off there and onto the market).
  - b. Involving the unsuspecting inventor in drug charges by planting drugs on his property surreptitiously, then secretly notifying the drug enforcement officials who suddenly raid the premises and discover the narcotics, resulting in the inventor going to jail since he has been caught "red-handed".

- c. Threatening the inventor's life and the lives of his family, to frighten him away from what he is doing.
- d. Arranging a fatal accident for the inventor, such as a fatal auto accident, a fall from a high place, or drowning.
- e. Assassination (hit men are fairly simple to hire; a good one is a bit more difficult to hire but is doable. A good hit man might assume a disguise and fake a robbery, shooting and killing the target in the "robbery". In an extreme case, he just fires at a distance with a professional sniper rifle that is silenced. A variation is the use of a "throwaway" assassin, a fellow who has been deeply conditioned by very harsh methods, to deeply involve his autonomic nervous system. He can be spotted by the "glaring eyes" effect of autonomic nervous system involvement. This fellow is only marginally functional in real life, and requires a handler. He also must "fixate" for some minutes (usually from 20 to 30) on the target, by staring at him for a period. Then — say, the next day — while the target is at lunch in a public restaurant, the throwaway walks in, walks straight to the target, and empties a pistol in him at point blank range. He remains there until the police arrive and arrest him. He is immune even to torture; nothing can be gotten out of him, even by electrical shocks on his genitals. There are two levels of throwaways; that is the older and less functional version produced by very harsh means. The more modern version is without the glaring eyes with white showing above the iris; this fellow is more functional, fixates very quickly (couple minutes to five minutes), and can operate without the close immediate presence of the handler.
- f. Making the inventor an offer he "cannot refuse", in the old Mafia sense. In the latter, nicely dressed persons come to the inventor's house, meet with him, and offer him a large sum of money to quit what he is doing for the rest of his life. The going sum varies between \$5 million and \$10 million, usually. The offer is real and it cannot be refused; either the inventor accepts it, or he and all his family are dead when these gentlemen leave the premises. If the inventor refuses anyway, he and his family are killed.

Usually the bodies also just "disappear" and are never found or heard from again.

- g. These days, variations are used such as a careful crash of another auto into the back of the inventor's car so he is really shaken up badly but not seriously hurt. He goes to the hospital for checkup, in case of concussion etc. Everything is seemingly okay, but he is kept overnight for observation. That night he is given a hypodermic of air in his veins. Next morning his family receives a call that the inventor has suffered seizures from an apparent concussion after all, and is fighting for his life. If he doesn't die, he becomes a human vegetable. Piece of cake.
- h. Then there's the ice dart dipped in curare. The curare paralyzes the muscles of the heart and lungs; the inventor goes down in convulsive floundering, gasping and unable to breathe or to pump blood. He expires very quickly. The curare breaks down in the body, the ice melts, and you have a fellow the medics find died of convulsive heart seizure, etc. Works like a charm. This is an adapted "dirty spooks" trick, adapted from those branches of the intelligence communities of the world that specialize in assassinations.
- i. Use of "gaming", which was originally developed to influence or change the behavior of foreign leaders. Imagine writing a scenario, as for a movie. Only you have the deep psychological profile of the targeted individual. You also have the deep psychological profiles of quite a few other individuals who have "knee-jerk" reactions in a certain direction useful to you in your games (in your scenarios). These are called "agents of influence" since, to get them into interacting with the target, only a phone call or other contact need be made and a stimulus given, and they are off and running, self-powered and going after that target with their knee-jerk response. So very sophisticated computers are used, the scenario (intended plot of events to happen) is prepared (the artificial intelligence programs will even give the probabilities of success of all the variants), and a recommended scenario variant is derived and accepted. Then the controller has one or more agents working **for** him that contact the players (the agents of



influence). They get their phone calls or stimuli, react in predictable fashion, and come pell-mell at the inventor, interacting all over the board with him. The range of games is enormous, from stock schemes to lawsuits to infiltrating agents of influence into the internal organization of the inventor to money laundering, etc. The controller follows the progress, and only once in awhile makes slight adjustments (may need to trigger other agents of influence, send in one actual agent, etc.). Over the last 20 years, the gaming has become very expert. So many games can be launched against a single inventor that he usually is finished or nullified by one of them, eventually. Having been gamed over 200 times in the last two decades, I plan to write a book one day on the subject of the games and what to watch for.

- j. Finally, here is a sad and disconcerting rule, usually true. If you gather six persons together that you have known for years or even all your life, and they are the nucleus of the organization around you, watch what happens when success occurs and you really do pull EM energy from the vacuum and power loads, lights, etc. One-sixth of the population, seeing that, will shortly contract a very strange malady known as "gold fever". It is not just an *obsession*; instead it becomes an all-consuming *possession* almost in the biblical sense. An individual possessed by gold fever would kill his own grandmother to try to gain control of that system. If one or more of these "gold fever" transformations occur, that sets the group into profound conflict and vicious infighting, on every front. You get sabotage of equipment, sabotage of demonstrations, stealing of equipment, legal shenanigans, just name it. This has destroyed many groups. It will destroy many more.
- k. A variation is to send in a special agent who penetrates the group and becomes a member. Indeed, the high cabal has certain persons who specialize in just such penetration and are specialists at setting up disruption. They have had plenty of practice, and are very good at their trade. The identities of some of these "special agents" would surprise the casual observer. The so-called "overunity community"

is rather strongly penetrated and misdirected by a number of such special agents, in addition to a greater number of agents of influence.

1. Finally, the technical knowledge of most inventors and researchers in this field has been largely limited to ordinary electrical engineering and electronics. This means that the inventor often forms his own lexicon and way of thinking about how he does the "magic" COP>1.0. It may be difficult or impossible to connect the way he thinks back to legitimate physics. Further, most of the COP>1.0 community, the majority of electrical engineers, and nearly half the physicists do not understand the technical difference between the *efficiency* of a power system and its *coefficient of performance*. We have insured that the reader of this book will know the precise difference — it's even in our glossary! Further, the entire group around the inventor, and the inventor himself, may not have a clear understanding of the source of the extra energy, the mechanism by which it is obtained, or even the difference between a system in equilibrium with its active vacuum environment and one in disequilibrium with it. Most engineers and a great number of scientists also are still unaware of the dramatic difference between the thermodynamics of equilibrium systems and the thermodynamics of disequilibrium systems. Many have no notion of what the active vacuum is or does. So the inventor may actually be able to build the device himself, but may later err and actually build it away from COP>1.0 with further development.
- m. Another problem can be measurement. Sometimes very simple errors — such as "measuring" highly nonlinear, spiky signals with an RMS meter, or using an inferior oscilloscope, or using inferior probes with good oscilloscopes, tricks a relatively inexperienced inventor himself into believing his unit achieves COP>1.0 when it doesn't. Also, some standard engineers will insist on calorimetry, which is inappropriate for COP>1.0 EM systems since they output a mix of both positive and negative energy. The positive energy will heat the calorimeter fluid and the negative energy will cool it

simultaneously, and the "expert measurer" will always measure the difference and thus  $COP < 1.0$  with his calorimeter (unless the inventor is a rare one who has also transduced the negative energy fraction of his output into positive energy). Yet the conventional engineer or scientist — who has never seen negative EM energy or a  $COP > 1.0$  EM system in his life — will be so confident from his "positive energy only" thinking that he will be completely convinced that a real  $COP > 1.0$  system, measured with a calorimeter to show net positive energy  $COP < 1.0$ , is *actually* a  $COP < 1.0$  system instead of the error in measurement that it is. One of the purposes of this book is to try to explain such things and get a better procedure and protocol made available for the testing.

- n. Finally, there are a few actual charlatans who deliberately deceive both the group around them (if it's sufficiently naive) and naive investors and backers. E.g., if one builds a huge starter motor (very high current, very high torque, cannot run long without burning up!) and puts it in an automobile, then fills the back of the automobile full of batteries, that beast will draw 400 amps and leap across the pavement or warehouse floor with an agility one is shocked to see. Then if the inventor is always "having difficulty with his controller unit", and "everything will be fine once the controller problem is licked" or some such, many small and naive investors will leap to invest their life savings eagerly. There are many other scams also, and unfortunately every experimental field, with great financial promise if successful, does attract them. Here the old adage is best: If it is just too good to be true, it probably isn't. One should insist on a technical explanation of the source of the excess energy, the mechanism by which it is taken from the environment, how asymmetrical self-regauging of the circuit occurs, etc. If these questions cannot be answered, the inventor himself does not know what he is doing. At best, he cannot explain it; or he may just be honestly mistaken. In the worst case, the inventor knows it is not genuine, but is deliberately deceiving the investors. So my advice would be to first assess the scientific level of the understanding of the inventor group. Then get an independent test of the

device or see one done properly. Then decide whether what you have seen and heard is real or not.

- o. Meanwhile, there are from time to time legitimate COP>1.0 systems initially developed. The place where all of them have failed is where the inventor group seeks to obtain the appreciable financing (something like 30 million dollars is required these days) to complete the phenomenology experiments, modeling, scale-up factor determination, and prototyping before a production model can be built. To date, every one of the legitimate COP>1.0 systems has foundered and failed right at that sheer vertical cliff. Our own MEG system is at that cliff at the moment, so that cliff is very near and dear to the hearts of the five of us who have struggled so long and invented the MEG. Time will tell whether we succeed where all the others have failed, or whether we also just get defeated by the cliff. As of this writing, we have not yet obtained the necessary capitalization. But we are giving it our very best try, and we believe we will win it eventually.

# Chapter 5

## Selected Approaches to Overunity Power Systems

[On point-contact transistors]. *"First, the theory underlying their function is imperfectly understood even after almost a century..., and second, they involve active metal-semiconductor contacts of a highly specialized nature. ...The manufacturing process is deceptively simple, but since much of it involves the empirical know-how of the fabricator, the true variables are almost impossible to isolate or study. ... although the very nature of these units limits them to small power capabilities, the concept of small-signal behavior, in the sense of the term when applied to junction devices, is meaningless, since there is no region of operation wherein equilibrium or theoretical performance is observed. Point-contact devices may therefore be described as sharply nonlinear under all operating conditions."* [William B. Burford III and H. Grey Verner] {282}.

### 5.1 Introduction

In this chapter we present a selection of potential overunity notions, inventions, and experiments by various inventors and researchers. Its purpose is to show some of the more relevant work that has been done, and hopefully to stimulate new thinking by the interested reader. It is not intended to be all-inclusive, but merely representative. Most of the work addressed is by other inventors and scientists, and we give an appropriate commentary from our viewpoint as best we understand the invention and the process used. Not all the concepts presented can be clearly explained, though some can and are.

This is not intended to be a "kit of parts" or an assembly instructions type of presentation. For that, the interested researcher will have to rely on his or her own ingenuity and lots of bench experiments, because no such "kit of parts with instructions" for COP>1.0 electrical power systems exists at present {283,284}.

## 5.2 Tesla's Shuttling of Potential Energy and Barrett's Extension

See Figures 4-4 and 4-5 in Chapter 4. In his patented circuits, Tesla accomplished the novel function of "shuttling" the potential itself (and therefore potential energy) around in the circuit at will. This startling function accomplished by Tesla is impossible to see in a conventional vector or tensor analysis of his patented circuits, but it is clearly evident in a higher symmetry EM analysis of them. So it does not appear in the conventional texts, which use vectors or tensors for their circuit analyses. Barrett, one of the leading higher group symmetry electrodynamicists and also one of the pioneers of ultrawideband radar, utilized quaternion electrodynamic analysis to clearly show this novel effect in Tesla's actual circuits {285}. Thus, Tesla was able to produce and move around asymmetrical self-regauging in his circuits, wherever he wished. That has been totally missed by scientists prior to Barrett's revealing analysis.

Barrett then went on to extend Tesla's basic mechanism and employ it for communication and radar purposes, obtaining two patents {286a-b}.

It would appear that use of such shuttling techniques is probably applicable to reducing the back emf in conventional nonshuttling circuits, leading to new COP>1.0 mechanisms. The definitive answer remains to be determined by some future researcher.

## 5.3 Moray's Radiant Energy Device

One of the remarkable examples of a successful COP>1.0 system was the radiant energy system of Dr. T. Henry Moray of Salt Lake City, prior to World War II. Figure 5-1- shows Dr. Moray and his final 50 kW unit, powering an assembly of light bulbs {287}. The device weighed 55 pounds, used an antenna connected as a "signal input" from the ether, but needed no input of electrical energy by the operator in order to achieve its steady power output.

As shown in Figure 5-2 and Figure 5-3, the various Moray tubes were complex in structure. In addition to various grids, they usually contained (in quadrature) three or more amorphous semiconductor pellets pressed in large presses and sintered with locked-in stresses. One points out the presence of optical effects including phase conjugation, possible use of the built-in stress as a sort of self-pumping and mild self-amplification, possible iterative feedforward and feedback loops due to iterative phase conjugation, collecting of additional energy from the usually nondiverged

Heaviside component via the iterative reverberation of energy, and non-interfering fields in quadrature.

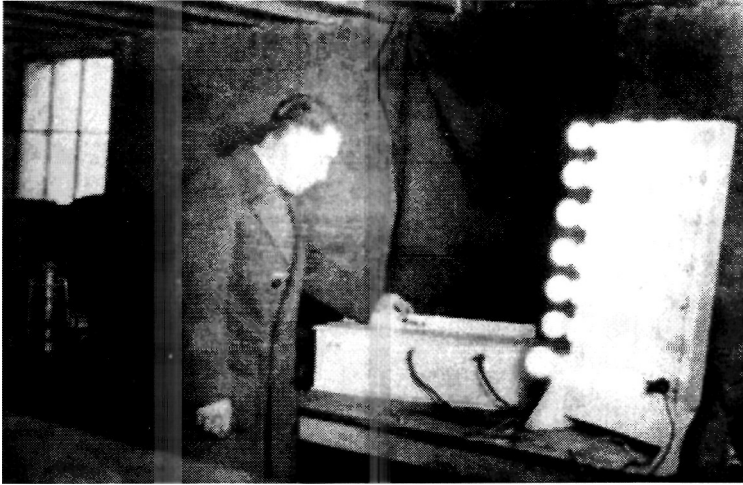

Figure 5-1 T.Henry Moray's 50-kW unit.

The blown quartz tube envelope, in the dark of an enclosure, is open to the passage of infrared (heat) and ultraviolet, which spans a harmonic interval. This allows the passage *of difference* frequencies as sine waves without breakup, even in a nonlinear isotropic environment. Moray stated unequivocally that the tubes would not work unless the envelopes were made of blown quartz. The pellets (shielded from outside light) would nonetheless receive IR input from the ambient temperature, and probably triggered at least weak UV due to the radioactive decay continuously ongoing in the semiconductors. We point out that the UV band is roughly twice the frequency of the IR band, so the "difference frequency" is roughly the IR band itself. In short, it may be that "difference frequency" IR is thus processed in Moray tubes in much more sophisticated fashion than has previously been suspected, including in a self-amplifying (regenerative) manner.

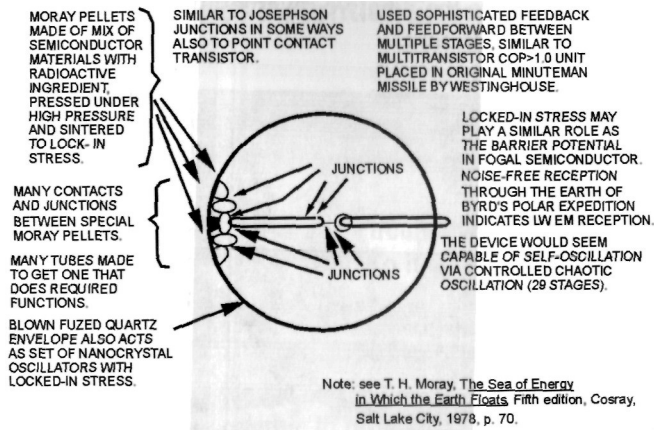

Figure 5-2 Diagram and some novel features of T. Henry Moray's special tube.

The pressed semiconductor pellets were placed in the tube in quadrature, in a sort of "point or junction contact" with each other.<sup>121</sup> Each semiconductor contained a mix of triboluminescent zinc (a semiconductor material), a radioactive material (probably uranium dioxide), and another material of unknown composition, rumored — but not confirmed — to possibly have been diatomaceous earth which also has some unusual properties one may look up. There were some 29 amplifying tube stages in the device. A U.S. patent {288} was eventually granted on an electronic therapeutic unit containing Moray tubes, but the patent on the power system was never granted, although the application was kept current for some years by the Moray family. Eventually the power device patent application files disappeared from the U.S. Patent and Trademark Office.

Although its full technical details were never released, the Moray device is of interest because Moray demonstrated it many times to engineers and scientists, under rigorous measurement conditions, for years. These expert witnesses then signed affidavits to the results achieved by Moray in the

<sup>121</sup> Indeed, the junctions of such sintered pellets are most interesting. Such a grainy junction can be compared to a host of very close point contact junctions, particularly with finely-ground powdered materials used in the pressing and sintering. In essence, Moray's junctions contained a great many "point contact transistors", and it is known that such transistors can behave (particularly under pressure!) as true negative resistors. This also appears to be one of Moray's secrets.



tests. Moray also discovered that he could produce an additional 50 kW of power simply by inserting an additional tap just prior to the formal output.

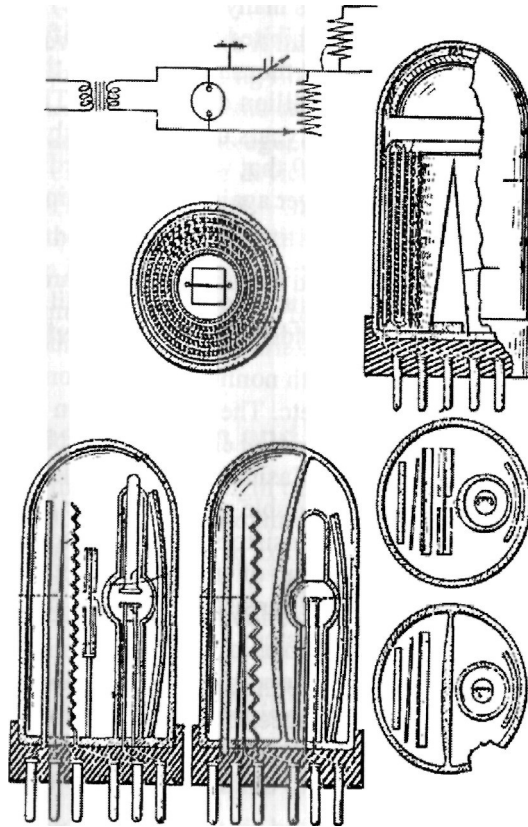

Figure 5-3 A variety of Moray tubes showing their complexity.

Repeated assassination attempts were made against Dr. Moray. While driving his car on the streets of the city, on several occasions he was fired at from an alley or from the sidewalk, but he had bulletproofed the car because of continual threats and ambushes. He was also shot in his own lab in a physical struggle with one would-be assassin, but survived although seriously wounded. A Russian company tried to steal the device, and a Russian agent was planted in Moray's lab, gradually sending essentially all the technical details of the Moray device to Russia. That

agent later destroyed the unit right in Moray's lab by suddenly smashing it with a hammer.

Moray's tubes were quite expensive and were painstakingly made by hand. He fabricated a number of tubes (as many as 30 or more) before he obtained one that "worked" and exhibited the self-amplifying effect. Over the years, he spent several hundred thousand dollars on the project, which is the equivalent of some twenty million dollars today. The 29 tubes in his final 50 kW unit were the result of years of labor and fabrication of several hundred rejected tubes to get the 29 that worked. Accordingly, once those 29 were destroyed, Moray was never again able to obtain sufficient financing to rebuild his unit.

However, Moray had demonstrated a special type of transistor years ahead of the first transistor patent. He had demonstrated the importance of multiple junctions in transistor materials. Optical and nuclear functioning of the tubes was also woven in with nonlinear oscillations, multiple feedforward and feedback loops, etc. The sophistication of the tubes and feeds alone almost certainly guaranteed chaotic self-oscillation. We suspect but cannot prove that the Casimir effect may also be involved in some of his conducting metallic double surfaces.<sup>122</sup> He had demonstrated a remarkable "tube-with-internal-transistors" that produced energy output self-gain, without any operator input of energy. In addition, he had successfully used his special tube/transistor hybrids to produce a very successful COP>1.0 EM power system.

After Moray's death, his two sons John and Richard continued to try to rebuild the unit, but were never successful due to lack of sufficient funding and lack of a proper scientific team. They do know how to build the tubes, however, and they do know how to build the unit.

It appears that no electrodynamicist or physicist skilled in higher group symmetry electrodynamics ever examined the Moray device or worked with Moray. No particle physicist or electrodynamicist skilled in non-Abelian electrodynamics ever worked with the device. Since broken

<sup>122</sup> The "grain" of the stressed semiconducting pellets may be important with respect to the Casimir effect versus the frequency. In short, Moray's contact surfaces between his semiconductors were "grainy" and these grains would have constituted Casimir surfaces. For the importance of the shape of the double surfaces, see M. Chaichian et al., "Quantum theories on noncommutative spaces with nontrivial topology: Aharonov-Bohm and Casimir effects," *Nucl Phys B*, Vol. 611, 2001, p. 383-402.

symmetry was not discovered and proven until 1957, no technical person who worked closely with the unit was ever aware of the various broken symmetries by which some of the virtual energy of the vacuum can be and is transformed into observable EM energy.

Certainly no one ever worked with it that understood the peculiar action of the difference frequency in traveling linearly through an isotropic nonlinear medium. John Moray, who stalwartly carried on the Moray lab in Salt Lake City until a few years ago, does know how to build the tubes, and he knows the circuitry for the device. That he does not understand the "deep theory" is of no consequence — no one else does either. In the opinion of this author, a funded scientific team — carefully chosen and working with John Moray — could probably rebuild the Moray device. We would very much like to see a Moray unit in production and contributing to permanently solving the energy problems of the world. Sadly, that does not seem likely.

## 5.4 Anti-Stokes Emission and Similar Processes

Stokes' law states that the wavelength of the fluorescent light emitted by a phosphor or other luminescent substance is always greater than the wavelength of the radiation used to excite the fluorescence {289}. This condition was observed by Stokes in 1852 {290}. From an energy viewpoint, the collecting medium collects and dissipates some of the input energy in the medium itself (e.g., to accelerate moving molecules) and then emits the remainder of it. The "system" consisting of the medium, the experimenter's input, and the output is such that it usefully outputs as luminescence less energy than the experimenter inputs. Hence it exhibits a  $COP < 1.0$ , by absorbing excess energy in its "environmental surroundings".

Usually such a "law" generally holds but is sometimes violated in at least a few cases. Stokes' law is no exception. It applies for most cases of fluorescence and luminescence, but it does not hold for a few of them. In a few cases, the emitted wavelength is precisely the same as the input wavelength. This means that the collector/absorber re-emits all the collected input energy as fluorescence or luminescence. Here the  $COP = 1.0$ . This condition is known as the *resonance condition* and the emission is called *resonance emission*.

In other well-known cases, Stokes' law is violated and the energy emitted is greater than the energy absorbed. In other words, the system exhibits a  **$COP > 1.0$**  with respect to energy emitted versus energy input by the experimenter. This is known as anti-Stokes emission. It has been well

known for six decades that anti-Stokes emission processes do indeed output more energy than one has to input oneself {291}. This excess energy emission is usually euphemistically attributed to "additions from the internal energy of the molecule" and referred to as "negative resonance absorption by the medium" or just as "negative absorption by the medium".

Unless the excess energy taken from the physical medium of the system is replaced from outside the physical system, the anti-Stokes emission process produces cooling in the physical system and is self-quenching once the medium loses all the energy it can afford. For the overunity researcher, a huge hint is to search the literature for anti-Stokes type emission phenomena that do not result in media cooling. The Letokhov phenomena {292} are in fact such phenomena where the excess emitted energy is received from outside the physical system medium, and therefore from the surrounding active vacuum and/or the surrounding local curvature of spacetime.

Other than for a very few physicists — e.g., Bohren {24}, Letokhov {157}, H. Paul and R. Fischer {25} — there appears to have been little *effective* discussion of where the excess energy "extracted from the molecule" really came from initially, and how it is replenished to the molecule (if at all), and particularly *whether or not it has to be replenished to the molecule by the operator*. There has been no discussion of the local potentials as dipole asymmetries in the virtual energy exchange with the vacuum, although there has been inadequate discussion of the involvement of the Poynting energy flow (e.g., by Bohren, Paul, and Fischer). There has been no discussion of the possible involvement of the Heaviside nondiverged component of the energy flow, which is additional to the Poynting component but unaccounted by today's electrodynamicists. To my knowledge, the broken symmetry of every dipolarity has not been discussed with respect to such experiments.

The reader can see the point. If a mechanism exists or can be evoked to freely resupply the lost energy to the molecule from the other two components of the supersystem, then the resulting *self-replenishing* anti-Stokes emission phenomenon can be utilized as a legitimate and continuing COP>1.0 process. It remains to be seen whether this can be worked out. If we wish, the giant negentropy mechanism of the source dipole and source charge {308} may be considered universally proven cases of self-replenishing anti-Stokes emission, already exhibited by every charge and dipole in the universe.

At least one audacious scientist — Letokhov — has suggested that similar processes in certain systems can perhaps comprise true Maxwell's demons, yielding excess energy output and perhaps eventually a COP> 1.0 operation {293}. Russell has suggested that a similar COP>1.0 process is involved in the fiber fuse phenomenon {299}.

Over the last few decades there has been slow but important work in an optical area of possible anti-Stokes emission phenomena {294a-c}. A variety of strongly scattering, optically active media have been shown to produce substantially more energy output than the experimenter inputs to stimulate the output. However, most are being done in laser-like pumping situations and so the pump energy has to be furnished by the operator. This means that the "replenishment" energy to the medium is furnished by the operator, resulting in overall COP<1.0 performance. However, in self-oscillation conditions, the medium can be self-pumped (self-replenished, taking its replenishment energy from the active vacuum exchange when viewed in the supersystem), and in such conditions COP>1.0 performance is possible, at least in theory. Presently we know of no one who has achieved it — except in the destructive fiber fuse effect — but the work seems to be progressing steadily toward that eventual outcome.

## 5.5 Gain in Intensely Scattering Optically Active Media

This modern work — which may be regarded in one sense as extending the anti-Stokes emission effect — is largely being pursued in intensely scattering optically active media. A very nice example is given by Lawandy's experiment {295a-d}, shown in Figure 5-4. Figure 5-4a shows a comparison experiment in water without an intensely scattering optically active medium but with a fluorescent dye to show the emission interaction. Figure 5-4b shows the same experiment with titanium dioxide particles added to the fluid. The TiO<sub>2</sub> particles are sized so that their optical resonance is within the laser's frequency domain.<sup>123</sup>

First, as shown in Figure 5-4a, a small, weak laser beam is aimed into the solution, and a small "warm little glow" of fluorescence results just around **that** region where the laser beam interacts with the solution. Scattering in **the** medium is rather normal, and provides nothing of any great interest to the overunity researcher.

<sup>123</sup> In passing, we point out the involvement of the Bohren effect due to particle resonance. This collects additional energy from the usually nondiverged large **Heaviside** energy flow component.

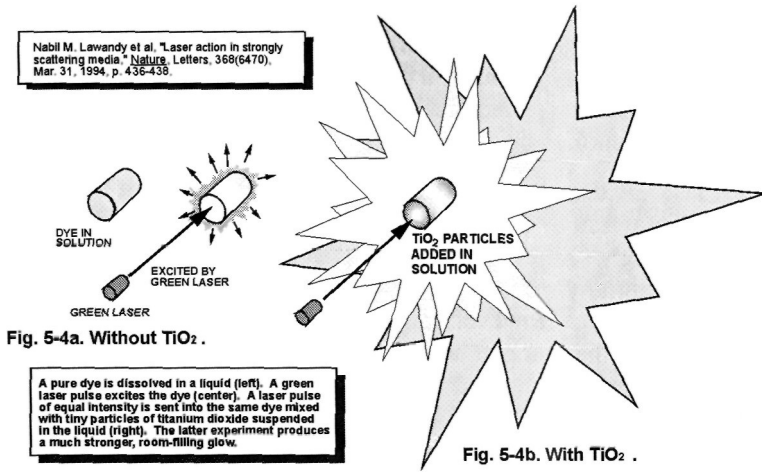

Figure 5-4 The Lawandy experiment

Then the titanium dioxide particles are added, and the same weak illuminating laser beam is directed into the colloidal solution. Figure 5-4b shows the new and spectacular results.<sup>124</sup> Immediately a very bright, room-filling emission of scattered coherent light fills the entire room. The intense optical scattering includes extensive retroreflections for some "ping pong" between individual particles, so that the optical gain is enormous. A highly enhanced energy emission is now evoked, for the same energy input by the operator as was used in the first experiment without the TiO<sub>2</sub> particles. Lawandy's experiment is inexpensive and can be repeated in any university nonlinear optics laboratory and by many individual experimenters. It gives results every time, without fail.

Oddly, no one seems to clearly state that, for a single pulse of input laser energy to the suspension of TiO<sub>2</sub> particles, precisely how much energy was input and how much energy was then emitted by the medium. Instead, "gain" is mentioned, but never the COP = (energy output by medium emission) / (energy input by operator). One suspects that journal referees would probably not allow such a clear and unequivocal statement of

<sup>124</sup> This is a very easy and very convincing argument for the presence of the long-ignored Heaviside component of energy flow arbitrarily discarded by Lorentz more than a century ago, and still discarded by modern electrodynamicists.

overunity, but would apply quibbling and spin control to prevent stating that more energy is output by the medium than is input to it by the operator.

It follows that, if sufficient "ping pong" iterative retroreflection and multiple collection occurs in the medium, the  $COP > 1.0$  because more work is done on exciting the medium than the energy input to it by usual (Poynting) calculations. No one accounts the energy unwittingly input to it by the ignored Heaviside component accompanying the Poynting component. Usually the output/input is just referred to as "optical gain". We stress, however, that we are considering only the actual laser beam energy being furnished into the colloidal solution as input, and we are not calculating the efficiency of the laser, its pumping, etc. Anyway, for this stimulated emission process, it is possible that the  $COP > 1.0$ , and one can see the parallel to anti-Stokes emission. In short, we are considering the  $TiO_2$  solution itself as exhibiting a true negative resistor action.

The field of high gain stimulated optical emission is advancing rapidly {296}, although many experiments still use external pumping furnished by the operator. If the operator has to pay for the replenishment (pumping) energy as well as the input energy, then the  $COP < 1.0$  overall. But the experiments are tending toward sustained self-oscillation and self-pumping conditions. If such conditions are obtained in sufficient magnitude, the process will then become a legitimate  $COP > 1.0$  operation overall. In that case, it will be usable as a basis from which to develop self-powering  $COP > 1.0$  electrical power systems, particularly for infrared "heating" systems etc.

The more recent experiments have shown positive feedback loops both in the time-forward and time-reversed paths; trapping of light flow energy (both time-forward and time-reversed) in large random walks of more than 1,000 individual interactions; weak Anderson-type localization; and constructive interference of forward time and reversed time light paths. since such experiments can be performed in the infrared, they point toward a potential "*vacuum-energy-powered overunity heater*" as a **feasible** achievement in the future. In our opinion, there should be a determined and major Department of Energy program oriented to develop exactly that kind of system.

Such a heater can become self-powering by the presence of greater governed positive feedback during self-oscillation conditions, which will allow sufficient excess collection due to *multipass multicollection* from the usually wasted giant Heaviside energy flow component. This process —

with the self-excitation occurring spontaneously as a "kick-in" positive feedback process in an exploding gas — probably accounts for the phenomena observed in the gamma ray burster and other such violent "burster" cosmic phenomena. Re-ignition, afterglow, and similar effects are observed in gamma ray bursters. They are also observed with *remarkable* similarity in the latest experiments in intensely scattering optically active materials the laboratory. Similar phenomena occur in x-ray bursters as well, and perhaps even in the recently observed and confirmed gamma ray emissions from intense storm clouds.

Finally, we point out that many magnetic materials are also photorefractive, and they readily produce nonlinear optical effects at various frequencies. Some barium compounds are typical examples. As an example, multivalued phase conjugate reflection can occur {297}. Such effects did occur in the Sweet vacuum triode amplifier, to be discussed shortly. It may be that Sweet's conditioning of his magnets conditioned their barium nuclei into self-oscillation, self-pumping, and thereby into *self-replenishing* stimulated optical-type emission at ELF frequencies.

## 5.6 The Fiber Fuse

See Figure 5-5. Although presently a one-shot destructive process, another multicollection phenomenon exhibiting a novel  $COP > 1.0$  process is the *fiber fuse* {298a-e}. This is a well-known but unusual effect in optical fibers and in fiber optic cables.

See Figure 5-5a. Once initiated by simply heating the cable (as with a butane cigarette lighter), the fiber fuse ignites and is self-sustaining. In those susceptible systems utilizing power on the order of one watt or so, the ignited fiber fuse propagates down the cable slowly, at about a meter per second nominally. It is evidenced by a bright white light propagating down the fiber, resembling the burning of a fuse for explosives — which led to the name "fiber fuse".

In fiber optic cables, it occurs only in those that contain germanium in their cores, and not in those containing just silicon in their cores. It moves down the fiber or cable at approximately one meter per second, and it is unlimited in the length of cable that it will continue along and march to the end. In the core, the marching fuse is actually "hopping", so to speak, and it melts a little "hole" about every centimeter or so, blowing out the material from the hole as it occurs. This "steadily and slowly marching" series of core melts results in the catastrophic destruction of the optical fiber core of the cable and thus destroys the functioning of the cable.



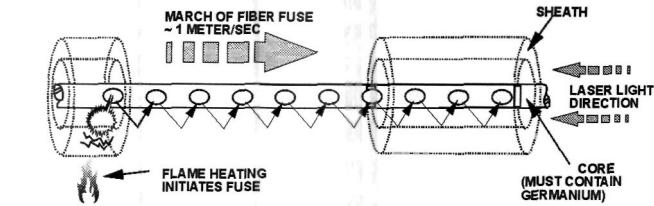

Figure 5-5 A. Fiber fuse destroys core of fiber optics cable of indefinite length, pitting core with holes.

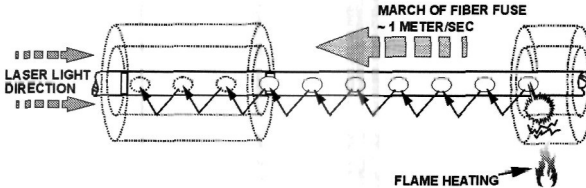

Figure 5-5 B. Reversed second fiber fuse often restores pitted core in cable, filling holes back up.

Figure 5-5 The fiber fuse.

The mechanism has been theorized to be self-propelled and self-focusing. Other experiments have found evidence for thermal shock waves and chemical reactions.

But see Figure 5-5b. Astonishingly, after a — say — 1 kilometer fiber optics cable is destroyed by such a fiber fuse, it is often possible to "heal" the damage by reversing the direction of the normal laser light propagating down the cable, while re-initiating the fiber fuse from the other end by heating the cable on that end. In that case, sometimes the *reverse-ignited* fiber fuse will then march right back down the cable, precisely refilling those previously-melted little holes every centimeter or so, *restoring the functioning of the cable!* If ever a phenomenon cried out for further painstaking investigation to determine its actual mechanism, the fiber fuse is it.

Truncated coupled-wave theory applies to this phenomenon. A rigorous **analysis** by Russell {299} of power conservation in dielectric gratings has shown that truncated coupled-wave theories do not rigorously conserve power. Predictably such conclusions have been disputed {300a-300d}, however, and are adulterated by the same old use of Lorentz-surface integration of the Poynting vector around the grating and discarding of the nondiverged Heaviside energy flow component. Those disputing the results and claiming the impossibility of  $COP > 1.0$  systems continue to ignore the unaccounted Heaviside energy flow component accompanying

every EM energy flow situation. In fact, they continue to unwittingly discard that component, and so have never performed *afullly* adequate analysis of any circuit or process. They also are unaware that all EM energy in 3-space comes directly from the active vacuum — specifically, it enters 3-space from the time domain and then returns to the time domain.

As long as the Lorentz surface integration scheme continues to be ubiquitously used without understanding what it does with respect to energy flow accounting, the dispute will not be dissolved. Presently both sides still use the Lorentz integration and discard the available Heaviside component. So they are really disputing whether the *Poynting diverged component* of the input energy can be equal to the energy dissipated. The answer to that is simply "No!"

Of course in a lab test the fiber fuse can be initiated with small Poynting energy input by precision point heating. In that case, the total energy required to melt the holes and move the material out of them, every centimeter or so down that (unlimited) length of cable, can be made as large as one reasonably wishes, simply by making the cable as long as one wishes. In short, COP $\gg$ 1.0. As can be seen, it can be experimentally proven that the input *Poynting* energy component can be far less than the total energy dissipated in damaging the cable. On the other hand, the energy dissipated in damaging the cable *is not* greater than the sum total of the usually calculated Poynting component together with the neglected extraordinarily large Heaviside nondiverged component. Conservation of energy is upheld, but only if the long-neglected Heaviside component is also accounted.

It stands to reason that the reverse fiber fuse can also be initiated by less input Poynting energy component than the total energy dissipated in restoring the cable. At that point, conventional theory has a problem. One can start with a good cable, put in a little EM energy twice — once to ignite the fiber fuse and once to ignite the reverse fiber fuse — and one winds up with a good fiber optics cable and having done lots more work inside the cable than the amount of energy one input by conventional considerations. We leave the solution to that problem as an exercise for the reader. Again, unless one includes the long-neglected Heaviside component, there is no way to make the energy flow balance, and one will have an experiment that seemingly contradicts the conservation of energy law. It doesn't, and that is the exercise the reader should understand.

So unless one uncovers and specifies the external source (Heaviside's energy flow component) of excess energy feeding the fiber fuse, it is a

demonstrable experiment whose efficiency  $\xi$  seemingly winds up being  $\xi > 1.0$ . It works every time and seemingly violates the conservation of energy law *as that law is conventionally and imprecisely stated for an equilibrium system only*. The COP $>1.0$  fiber fuse phenomenon does not violate overall conservation of energy because the system is not in equilibrium with the other two components of its supersystem. It only violates (permissibly!) the conservation of energy statement for a system in equilibrium. The "system" consisting of the fiber fuse and the cable is *not in equilibrium in its energy exchange with its active environment (with the other two components of the supersystem, consisting of the active vacuum energy exchange and the active local curvature of spacetime)*. We point out, of course, that the Heaviside component is flowing in space outside the physical system, hence in the vacuum and therefore in the external environment.

*Specifically, every dipole in the system is extracting and pouring out energy from the vacuum, and only the small Poynting diverged component of this available energy flow is ordinarily caught. The extreme nonlinearity (and some resonances!) of the particles in and exposed to the extraordinarily locally heated fiber fuse do sweep out a greater reaction cross section than do cold, static charges, in a fashion similar to the separate demonstration of such extended geometrical reaction cross section in the Bohren experiment {301}. Hence the fiber fuse subsystem and the associated particles of melted matter from the holes do intercept, diverge, and collect some of the accompanying but usually nondiverged Heaviside component.*

See again paragraph 2.1.6 in Chapter 2. Iterative retroreflective systems — such as in intensely scattering nonlinear optical materials — are not necessarily limited to COP  $< 1.0$ . Such a system is not necessarily limited to only the energy input by the operator, and it is not limited to only the operator's input Poynting component. Instead, the system can receive an input of excess energy from (i) its active local vacuum, and/or (ii) the local curvatures of spacetime. Its efficiency  $\xi$ , however, is always  $\xi < 1.0$ , even when its COP is clearly greater than 1.0.

Since scientists disputing the energy aspects of the fiber fuse only have assumed an equilibrium system and have not considered the neglected Heaviside energy flow component, the present arguments against COP $>1.0$  performance of the fiber fuse are quite irrelevant.

We also point out that an optical phenomenon is involved, and that the core materials in the melt are optically active. Hence, appreciable iterative

phase conjugate retroreflections occur in the fiber fuse itself and particularly in the melt materials (in the "inferno" of the "spot" itself). This asymmetrical self-regauging process gets more than one joule of work from one joule of original input Poynting energy, because of the iterative (and reciprocating) change of form of the energy. That operation produces iterative joules of work for each joule of original input energy, plus the unaccounted original input of the Heaviside component.

Again, there is no law of *conservation of work* in nature. The present conventional energy-work theorem erroneously considers only a "single interception and change of form" of the energy collected in the system, before loss of the energy from the system. Therefore, it only considers each joule of input energy performing one joule of work on the system to "excite" it to a higher potential energy state. It also considers that, once a joule of energy is then dissipated from the system as work in an internal load or process, it has departed the system forever and is not returned to do additional work by having its form changed yet again! In intensely retroreflective or intensely scattering systems, those conventional assumptions do not necessarily hold. For analysis of the fiber fuse phenomenon, the extended work-energy theorem must be utilized.

Finally, we point out the connection of this fiber fuse phenomenon to the similar "runaway" phenomena we have previously postulated as involved in producing the x-ray burster, gamma ray burster, etc. where iterative retroreflection and thus asymptotic rise in energy density is involved.

Another possibly related phenomenon is the unexpected explosion of porous silicon, as discovered at the Technical University of Munich {302}. The porous pellet involved in the unexpected experiment is covered with a layer of hydrogen atoms. In the presence of oxygen penetrating the oxygen barrier, an extraordinary and superfast chain reaction is initiated. The power of the explosion is some 10 times that of TNT. In the inferno portion of the fiber fuse, the "melt" as it puddles and then particulates, should be in the presence of oxygen and hydrogen from air in the cable. This dramatically differs from the explosive pellet, but may be sufficient to ignite at least in a local area rather than explode violently. If so, between the ablating particles of silicon there could exist iterative phase conjugation, thus producing an asymptotic rise in temperature and energy, perhaps sufficient to sustain the fuse. At least this possibility should be investigated.

## 5.7 Multiple Feedforward and Feedback Semiconductor Loops.

DeSantis *et al.* {303} showed that feedback systems with a multipower open loop chain can produce  $COP > 1.0$  performance. In semiconductors, the present author hypothesizes that complex feedforward and feedback loops involving semiconductors can induce time reversal effects, hence some movements of current against the voltage. In short, there can arise a true negative resistance effect, as demonstrated in the Fogal transistor.

Indeed, a Westinghouse frequency converter using 64 transistor stages and similar sophisticated feedforward and feedback mechanisms was placed in the original Minuteman missile, then was later deliberately modified by Westinghouse engineers to prevent its demonstrated  $COP > 1.0$  performance.<sup>125</sup> The specific germanium transistor used in the converter was also withdrawn from the market.<sup>126</sup> In those days, power meant weight and weight was at a premium in missile design. The power supply was very tightly designed, so that the weight could be minimized.

The converter had been deliberately designed to be 90% efficient, which was quite the state of the art. However, placed in the missile, the average converter would produce from 105% to 115% times as much output power as input power. (We are stating a  $COP > 1.0$ , *not*  $\xi > 100\%$ !) This was more output power than the tightly designed succeeding stages were designed to accept; consequently those overloaded follow-on circuits often burned out and deadlined their Minuteman missiles — something of great strategic concern at the time. The increased rate of Minuteman missiles out of action due to this problem placed great pressure on Westinghouse executives. In turn, they simply ordered the engineers to "fix it!"

Westinghouse simply "fixed the problem" very directly. The engineers reduced the output power of the converter by adding limiting diodes etc. Very quietly, Westinghouse then obtained several patents {304a-c} surrounding the technology, but no further mention of it appears in the literature. The Westinghouse work continued for at least a decade, judging by the spread of the patent dates.

<sup>125</sup> Our information came directly from private conversations of a close scientific colleague with the Westinghouse engineers who thoroughly tested the converter **causing** the Minuteman problems, and who then altered it to prevent the problems.

<sup>126</sup> Germanium has some unique properties, particularly with respect to transducing surface longitudinal waves to transverse waves and vice versa.

Such multi-loop, multi-feedback transistor circuits can apparently be developed to exhibit true negative 4-resistor effects. With specialized clamped positive feedback of the Bedini type, such open dissipative systems can then exhibit stable  $COP > 1.0$ , since the energy is taken from the vacuum via the broken symmetry of dipoles, and then discharged asymmetrically in the loads so as not to destroy the source dipole negative 4-resistors. However, the reader should see Chapter 9 for special considerations and phenomenology.

## 5.8 Negative Resistors

We define a *true negative resistor* as a circuit component or system that receives energy from the environment and outputs useful energy, either in altered form or to power loads usefully. This contrasts sharply with a *differential negative resistor*, which exhibits negative resistance in one part of its regimen, but where all the excess energy to move the current against the voltage in that regime was previously drawn from the circuit itself and therefore was not freely received from the active external environment. Instead, the operator paid for it already. We are not interested in differential negative resistors, which are well known in the literature {305} and do not enable  $COP > 1.0$  system performance, so we will not discuss them further. Hereafter when we use the term "negative resistor", it is understood that we mean "true negative resistor" unless the term is otherwise qualified.

The true negative resistor is an open dissipative system *a priori*, and equilibrium thermodynamics therefore does not apply. Instead, the thermodynamics of open systems far from equilibrium applies. The negative resistor freely receives energy from outside the system (from the environment), and "dissipates" it in interception and collection actions inside the system, to freely increase the available potential energy in the system.

In circuits, the main characteristic of a negative resistor is that the environment freely furnishes some excess energy to (i) power the load, and/or (ii) move the current back against the voltage, particularly when shunted across the back emf region of the source dipole. The *operator* does not have to furnish this excess energy dissipated to propel the current backwards or dissipated to power the load!

One must incorporate the entire supersystem into the analysis of a negative resistance element or system. Since the operator does not furnish the input energy dissipated by the negative resistor, then the active vacuum or

curved local spacetime — or both — must furnish the input energy to it. One must consider local curvature of spacetime interactions with the negative resistance and the active vacuum interactions with it, as well as the interactions between active vacuum and local spacetime curvature. In other words, one must again include the active environment of the Maxwellian system that Lorenz/Lorentz symmetrical regauging arbitrarily discarded.

We specifically do not include the well known "differential" negative resistor, such as a tunnel diode, which in one regime moves current against the voltage, all the while drawing all its enabling energy to move current against the voltage from an overall previous energy input by the operator. Unless the input enabling negative resistance energy is freely received from the external environment, true negative resistance is not involved.

Several true negative resistors other than the point-contact transistor have been produced. We review a few of them in the following subparagraphs.

### 5.8.1 Kron's Negative Resistor

One of the greatest American electrical scientists was Gabriel Kron. Working for General Electric (GE), Kron built a true negative resistor in the 1930s, which could power itself and the network analyzer<sup>127</sup> at Stanford University, under a GE support contract with the U.S. Navy. Here is a direct quote from Kron {306} to show what we refer to:

*"When only positive and negative real numbers exist, it is customary to replace a positive resistance by an inductance and a negative resistance by a capacitor (since none or only a few negative resistances exist on practical network analyzers.)"*

In that sentence we believe that Kron was forced by the censors to insert **the** words "none or" in the expression in parentheses. Particularly note the suggestion that in the imaginary realm it may not be the same as the accepted practice of using inductance as a positive resistor and capacitance **as** a negative resistor. Of course, the fourth Minkowski axis is - *ict*, and so this is very probably an oblique reference to the fact that energy can also "flow in" from the time domain. Kron was quite knowledgeable in general

<sup>127</sup>The network analyzer was a large analogue simulation capable of modeling sophisticated equations — such as Maxwell's equations, the Schrodinger equation. **etc.** — for use in designing, simulating, and analyzing naval communications systems or proposed systems. It was one of the most advanced simulations of its day. Kron was the chief engineer and scientist on the project, and one of the ablest electrical physicists the United States ever produced.

relativity as well as advanced electrodynamics, and he applied full general relativity to rotating EM machines etc. In another quote, Kron {307} also revealed that he had the negative resistor but was not allowed to use it to openly power the Network Analyzer. Quoting and reading through the "spin control":

*"Although negative resistances are available for use with a network analyzer, in practice it is more convenient to use a second type of circuit, in which the positive and negative resistances are replaced by inductors and capacitors and the dc currents and voltages are replaced by ac currents and voltages of fixed frequency. The use of the second type of interpretation is equivalent to multiplying the wave equation by  $i = \sqrt{-1}$ ."*

After the word "although..." Kron includes the blunt statement that negative resistors were indeed available for use with the network analyzer. But if the "convenient" replacement of the positive and negative resistors by inductors and capacitors was made, then there was no COP > 1.0 involved, and there was no true negative resistance involved. Kron is trying to clearly tell us that fact in the above quotation. He also strongly hints that energy from the time domain on the axis *ict* is involved, but that multiplication by  $\sqrt{-1}$  discards this "energy from the time domain".

Kron's negative resistor secret has never been released by General Electric, Stanford University, or the U.S. Navy and it is not going to be released. It has never been deciphered outside those groups, with the possible exception of knowledge by Floyd Sweet of Kron's negative resistor construction. Sweet worked in General Electric but not on the Network Analyzer project. Kron, however, was Sweet's mentor and patron, and Sweet often spoke of Kron in glowing terms. In our opinion, Sweet's vacuum triode amplifier was a further development of Kron's early negative resistor, as Sweet understood it.

We further believe that Kron's "open path" is simply the other two components of the supersystem, being (i) local curved spacetime, and (ii) the active local vacuum. Obviously the *external environment* connects any two points in the physical circuit, in addition to the circuit's physical connection (the "closed path"). Between any two points at differing potentials in an electrical circuit, there exists a potential and a dipolarity. Therefore, there exists a broken symmetry because of the dipolarity. The potential difference of that dipolarity is also a curvature of spacetime; i.e., it is a "field" between the two points, and the field is identically a curvature of spacetime. Hence from any two such dipolar points in the



circuit, there exists the giant negentropy flow of EM energy that we pointed out in 2000 {308}. This "open path" EM energy flow between any two unlike charges (any dipolarity) in the universe, not intercepted by the circuit and thus nondiverged, is discarded by Lorentz's integration of the energy flow vector around a closed surface enclosing any volume element of interest. It appears that Kron not only recognized (in different terms) what we are calling the "supersystem", but also recognized the equivalent of Heaviside's nondiverged EM energy flow component from any dipolarity — referring to that energy flow as the "open path" flow of energy. It is almost certain that he fully recognized what Lorentz symmetrical regauging did to the Maxwell-Heaviside equations. Thus it appears that Kron was the first scientist to discard Lorenz/Lorentz symmetrical regauging, producing his negative resistor by doing so.

We do not have firm knowledge, however, but only circumstantial evidence that Kron recognized the flow of EM energy from the time domain into 3-space, and vice versa, though he was certainly capable of seeing that. Nevertheless, this would also be included in his notion and discovery of the "open path", since it is included in every dipolarity, generating the scalar potential between the poles of the dipolarity. It may also have occurred to him from his excellent grasp of general relativity and spacetime curvature {309}.

Kron's concepts are certainly capable of being modeled and used to produce  $COP > 1.0$  EM circuits and systems, including his negative resistor. Kron did tremendous work in advancing EM networks and power systems. He left behind a great legacy of network and system analysis capable of dealing with the  $COP > 1.0$  electrical power system problem {310a-e}. Unfortunately, that legacy has been little used, if at all, in design of electrical power systems and power distribution networks today. To our knowledge, there are no electrical power systems deliberately using Kron's open path.<sup>128</sup>

### 5.8.2 Chung's Negative Resistor

A highly simplified diagrammatic illustration representing the Chung negative resistor is given in Figure 5-6. In a July 9, 1998 keynote address at the Fifth International Conference on Composites Engineering in Las

<sup>128</sup>A possible exception is provided by Barrett's extensions {286a, 286b} of Tesla's "potential shuttling" technique {124}, which can only be seen in higher group symmetry electrostatics such as quaternions. However, as far as we know, Barrett has **not** applied energy shuttling techniques to electrical power systems.

Vegas, Dr. Deborah D. L. Chung, professor of mechanical and aerospace engineering at State University of New York (SUNY) at Buffalo and Director of the Composite Materials Research Laboratory, reported that she had observed apparent negative resistance in interfaces between layers of carbon fibers in a composite material prepared under pressure.<sup>130</sup> The negative resistance was observed in a direction perpendicular to the fiber layers. By varying the pressure at which the composite material was prepared, Chung *et al.* were able to control whether the material would exhibit negative, minimal, or positive resistance. Apparent negative resistance was also observed in carbon fiber cement-matrix composites and in bare carbon fibers held together by pressure.

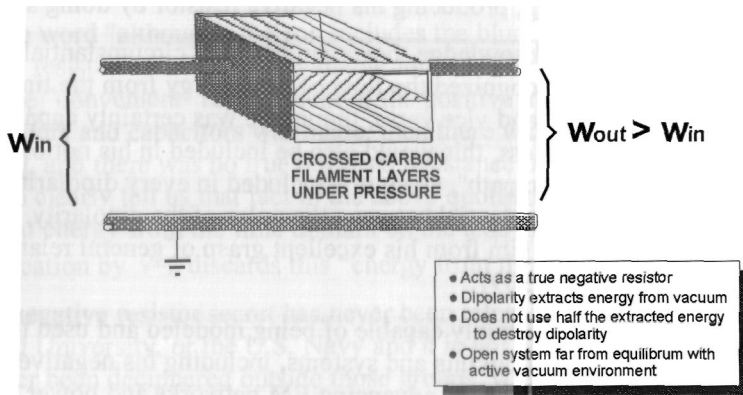

Figure 5-6 Chung's negative resistor (diagrammatic).

A formal technical paper was later published by Wang and Chung {311}. A few years earlier a patent {312} had been issued to Chung and assigned to The Research Foundation of State University of New York, Albany, NY for a superconductive material using a laminate combination of carbon

<sup>129</sup> Professor Chung holds the Niagara Mohawk Chair in Materials Research at SUNY and is internationally recognized for her work in smart materials and carbon composites. The reader may peruse a curriculum vitae, research work, and papers at <http://www.mae.buffalo.edu/people/faculty/chung/research1.doc>.

<sup>130</sup> The preparation of "locked-in" stress in Chung's carbon fiber material is reminiscent of Moray's similar preparation of his amorphous semiconductors with locked-in stress also.

fibers and metal.<sup>131</sup> The patent mentioned mesoporous carbon filaments, strikingly similar to our previous discussion of the surprising explosion of porous silicon at the Technical University of Munich, as well as possibly a special kind of "porosity" consideration in the fiber fuse phenomenon (in the material of the fuse itself).

An initial offer on the State University of New York at Buffalo website to provide a technical package with respect to the negative resistor — for which a patent had been filed — to those submitting a nondisclosure agreement was abruptly withdrawn. The project may have been classified, or — far less likely — it may have been retained as deeply proprietary by the University. We suspect that both the technical package and the patent application have been classified by one or more U.S. government agencies.<sup>132</sup>

In our opinion, Chung's fruitful discovery deserves rigorous and continuing investigation, particularly in higher group symmetry electrodynamics and in terms of supersystem interactions to include Dirac sea hole current interactions. We also believe Chung may have been required by referees (or by declassifying authorities, if such were involved) to use the term "apparent" in the paper. The reported measurements in the technical paper do seem to unequivocally include true negative resistance with current running backwards against the voltage. It is not clear, however, whether this is Dirac hole current or electron current or a mix of both.

We also call attention to the fact that Dirac sea holes in the local vacuum — as will be discussed in Chapter 9 — will and do run backwards against the voltage. Further, such hole current can be transformed from negative energy to positive energy by the Bedini process shown in Chapter 9. The pressure used by Chung *et al.* in fabricating the material produces a stress potential in the material and thus decomposes into our reinterpreted Whittaker 1903 decomposition, preciously discussed. So giant negentropy is involved in the composite material, which implies that true negative resistance can be involved, at least in some operational regimes as pressure

<sup>131</sup> We stress that the issuance of this unclassified patent does not rule out a possible negative resistor (hence  $COP > 1.0$ ) patent that may have been classified. Some sensitive defense work in special materials is indeed performed at SUNY at Buffalo.

<sup>132</sup> At least the gist of the work is not lost, however, due to Naudin's duplication of the Chung effect and placing the results and building instructions on his website in France; see <http://jnaudin.free.fr/cnr/>.

etc. are varied. Such results were found by Chung *et al.* and are reported in the paper.

Naudin reported independent success with a simpler variant of the Chung negative resistor {313}. This assures that at least the effect will not just be buried.

### 5.8.3 The Fogal Charge-Barrier Device

Figure 5-7 shows an illustration from one of William Fogal's patents {314} on a new kind of transistor (more accurately, a charge barrier device). Fogal's device incorporates a very special electrolytic capacitor<sup>133</sup>, which introduces optical-type functions as well as the more familiar capacitor functions.

## Fogal Semiconductor

- Blocks electron current flow  $i = dq/dt$ 
  - As capacitor charges electrons in emitter junction attracted to plate
  - Charging plate produces high barrier
  - AC conduction electrons cannot penetrate barrier
  - AC displacement current  $dQ/dt$  and Poynting current  $S = E \times H$  are passed through the barrier
- AC into the barrier produces AC Lorentz symmetrical regauging, which produces AC stress waves, which are longitudinal EM waves *a priori*
- Semiconductor becomes "energy pipe"
- Massless displacement current is energy flow without losses
- Energy can be collected and separately discharged through load for free work
- Transmission mode Holding potential while changing displacement current produces enfolded longitudinal EM waves inside potential accompanied by time-polarized phase conjugate twins
- Reception mode Receiving longitudinal EM waves at barrier provides scalar interferometry, making transverse EM waves
- Fogal semiconductor can both receive and transmit via enfolded longitudinal EM waves, which are not limited to the speed of light in vacuum
- Semiconductor can also be used as a true negative resistor.



DIAGRAMMATIC ONLY

Figure 5-7 Novel characteristics of the Fogal semiconductor.

Most semiconductor materials are optically active materials. Further, the individual electrons in a signal with a frequency well below light frequencies, are "jittering" with higher frequencies including the entire optical band. A "frequency" of a signal thus is imbedded in a jittering higher frequency complex set, and that set is quite able to interact in optical fashion *if the complex itself is used and controlled*. Fogal's process

<sup>133</sup> The exact method of manufacturing this electrolytic capacitor, and its internal structuring, is proprietary to Fogal and a major capacitor manufacturer, who is under a nondisclosure agreement with Fogal.

does appear to both use and control that jittery high frequency signal complex.

Hence Fogal's process can "tunnel under" the normal *detected* force-field frequency responses of the individual electron,<sup>134</sup> and directly affect, change, and alter its higher-frequency environmental changes in the force-free field or field-free potential condition. In this way, Fogal has carried the electron (and hole) functions of a transistor to functions well beyond those in the present texts {315}. He may have also extended quantum mechanical tunneling effects to signals between widely separated regions of spacetime, since superluminal communication is possible with the Fogal semiconductor properly used. Longitudinal EM waves — which Fogal's semiconductor is able to utilize and control — can and do move at superluminal speeds {93a} because it uses the long-neglected "infolded" longitudinal electrodynamics revealed by Whittaker in 1903 and 1904. Further, superluminal solutions to Maxwell's equations do exist {93b}.

The charge barrier device is formed in a bipolar design that can be incorporated in Metal Oxide Semiconductor (MOS) designs as well as multiple gate devices. The device also produces a Hall effect EM field internal to the device. The Hall effect magnetic force will force electron flow and angular spin of the electrons in the same direction to the top of the conduction bands in the crystal lattice on semiconductor devices, unlike Silicon On Insulators (SOI) devices that force electron flow to the surface of the semiconductor lattice. This forcing function, together with the "extended tunneling" effects on the embedded EM environment of the electrons and holes, produces a unique effect. The device is able to stop and "pin" electrons while continuing to process the signal energy flow (the entire jitter signal complex) in which the electrons were coupled and moving. Thus the Fogal transistor is able to operate upon and with mass-free spacetime itself, and curvatures thereof. It is the first practical semiconductor capable of performing *engineering of the active vacuum*.

In the last few years we have stressed that EM waves in spacetime are longitudinal EM waves *a priori* — but they are accompanied by time-polarized waves (phase conjugates). Hence the two in combination become observable, as pointed out in quantum field theory by Mandl and Shaw {316}. *We detect effects a priori and not their causes. We detect*

<sup>134</sup>The electron itself is enveloped in the jittering of whatever background it is exposed to and interacts with. Hence a coupling interaction exists to arrange and **control** the jitter of the electron as well.

transverse *electron precession waves* in our detector circuits, and not the causal waves interacting with them to produce their precession. *The Fogal transistor is able to process the causal longitudinal EM waves directly, prior to their interaction with matter.* It in fact opens up an entirely new region of "detected physical reality" to our vision and detection, a region far more extensive than the development of infrared and ultraviolet sensors opened up to our sight.

The pioneers of electromagnetics, who erroneously assumed a material ether and EM force fields in space, confused the transverse "material detected waves" (electron precession waves) in the detector with the "material undetected waves" they assumed to be incoming from space. Note that neither the electron nor the atom had been discovered when all these assumptions were used to determine how the EM wave in space was to be viewed and modeled. The transverse waves observed in the interacting/detecting of the Drude electron gas — i.e., the detected electron precession waves — were considered to be direct interceptions of the incoming causal waves from space. This already substituted the effect for the cause, as we have previously discussed.

Further, Faraday envisioned the "material field in space" as consisting of a series of "taut physical strings". A "perturbation" of this field in space was, in his view, simply the transverse wave plucking of those strings. Maxwell, who closely followed Faraday's experimental work and concepts, simply assumed the transverse "plucked string waves" advanced by Faraday. Therefore, the erroneous notion of the transverse EM wave in space arose and stayed firmly fixed in the theory.

One can check Whittaker's decomposition of the scalar potential into longitudinal EM wave pairs, then realize that the energetic vacuum is naught but a giant scalar potential — which can be decomposed by Whittaker's method. In short, as a scalar potential, space itself is a writhing mass of longitudinal EM waves and their highly nonlinear dynamics and interferences, or it can be modeled in that fashion. The energy continually enters 3-space from the time domain to the negative charge of every point in space considered as a point dipole, thence to the positive charge, thence back to the time domain. Notice the giant 4-space circulation involved. One also notes the polarization of the vacuum continually happening and arising spontaneously, as is well known in quantum mechanics. We also suspect that this or a similar mechanism is at the root of spontaneous broken symmetry in physics.

An interesting thing emerges from Whittaker's 1904 paper {317}, where he showed that all EM fields and waves can be decomposed into differential functions of two scalar potentials. Each of these two base scalar potentials can be decomposed by Whittaker's earlier 1903 paper {85} into a set of longitudinal EM waves. All EM fields, potentials, and waves are comprised of longitudinal EM waves and their internal dynamics, which also comprise waves of spacetime curvatures and their dynamics. Further, each longitudinal EM wave in 3-space is accompanied by its phase conjugate twin in the time-domain.

This far more primary "internal electrodynamics comprised of pure spacetime dynamics" — comprising and creating the recognized EM potentials, waves, and fields, their internal dynamic spacetime structuring and also the structuring of time — has not been developed and applied in physics theory. This internal or "infolded" electrodynamics is the primary "medium" in which the Fogal semiconductor appears to work and work upon. The Fogal semiconductor seems able to modulate and demodulate this internal structuring or parts of it, as has been demonstrated.

Imperfect longitudinal EM waves — called *undistorted progressive waves* - are already known to be able to travel at superluminal velocity, e.g., as shown by Rodrigues and Lu {318}. Indeed, Maxwell's equations have both subluminal and superluminal solutions, as shown by Rodrigues and Vaz {319}. Further, these waves can carry information. However, the *technology* of employing these waves has been lacking {320}. The use of scalar EM wave interferometry to produce normal EM fields and EM field energy at a distance has been shown by Evans *et al.* {321}.

As pointed out by Rodrigues and Lu {318}, perfect longitudinal EM waves travel at infinite velocity. This eliminates the difference between potential, field, and wave; a perfect longitudinal EM wave can also be taken as an instantaneous scalar potential with net force-free iterative regauging (varying at each point instantly and simultaneously). Both ways of looking at it produce the same end result: instantaneous remote energy change of spacetime energy density itself, in general relativity terms, or of the energy density of the vacuum, in particle physics terms.

Elsewhere, (e.g., Chapter 2), we also pointed out the "total photon **interaction**" mechanism that generates the flow of an entity through time. We also have advanced the concept of a "time-reversal zone" (TRZ) as a region where antiphoton interactions with charges predominate over photon interactions. We used these new concepts to propose exact nuclear **reactions** for the production of excess deuterium, tritium, and alpha

particles in cold fusion experiments. In such an "excited state" TRZ region, the law of attraction and repulsion of charges is reversed. In the TRZ, like charges attract and unlike charges repel. Further, the gluon forces are reduced, so the quarks in the nucleons are much more lightly bound. In such TRZ zones, dense clustering of like charges occurs due to their mutual attraction.

A time-reversal zone is created in one part of the Fogal transistor, greatly assisting in the "electron pinning" action. That is, the usual strong mutual repulsion (the Coulomb barrier) of the electrons at the pinning site vanishes in the TRZ inside the Fogal semiconductor, and the resulting mutual attraction of the electrons greatly facilitates the pinning process far beyond what is usually obtained against "like charge" repulsion in a time-forward zone. Indeed, the TRZ in the Fogal semiconductor also materially enhances the electron pinning process beyond what can usually be obtained with cryogenics. At least some indication of trapping and perhaps pinning has been reported in amorphous semiconductors at room temperature {322a-b}.

The Fogal device is able to remove EM noise (electron noise) from existing EM signals, displays, etc. by 96% or more, by pinning the electrons and simultaneously time-reversing the spatial EM signal back to its original noise-free state prior to hosts of interaction electron collisions. This "noise removal" capability has been rigorously tested by independent parties, including at a leading university in the Netherlands,<sup>135</sup> and by several large electronics companies and several other universities. By pinning the electrons (and electron currents) while still processing and propagating the EM energy effects, the Fogal device can move noiseless EM energy without loss at room temperatures, at superluminal velocities, and reconnect the lossless propagated energy to electrons past the pinning region at a receiving region, releasing the electrons in the receiving region. The Fogal semiconductor therefore already accomplishes *room temperature superconductivity* as well as tunneling.

The Fogal device's basic mechanism (consisting of all the submechanisms) is to restore and move EM energy in force-free form, using direct regauging of the vacuum instantaneous scalar potential itself (or the

<sup>135</sup> The university researchers verified room temperature superconductivity being produced by the Fogal semiconductor in their independent verification measurements. They also measured that some 96% of the noise already present in a circuit was removed by Fogal's semiconductors in Fogal's circuits.



vacuum potentials themselves). It operates directly upon the longitudinal EM waves comprising the vacuum potential. Hence it directly engineers the active vacuum and curved spacetime. I.e., it is the first *supersystem engineering* device of (hopefully) many more to come.

In the "jitter" environment of the space in which the individual electron is embedded, there exist many (and essentially all) field gauges, simultaneously. One of these, of course, is the Coulomb gauge where there exists an instantaneous scalar potential. Usually the instantaneous scalar potential is considered only a *near-field* effect, with no contribution at any significant distance. However, as Jackson points out {323}, transverse radiation fields are given by the vector potential alone. Also, in the Coulomb gauge the scalar potential "propagates" instantaneously everywhere in space {324}.

Along with other electrodynamicists, Jackson avoids the obvious superluminal communications implications of the instantaneous scalar potential by stating that "*..it is the fields, not the potentials, that concern us.*" As he points out, a detailed (*though conventional*) discussion of causality is given by Brill and Goodman {325}. Again as pointed out by Jackson, in the Coulomb gauge the quantization of the photon involves only the vector potential. *The use of the scalar potential in the Coulomb gauge, together with deliberate engineering of the internal longitudinal Whittaker wave structure of that potential, directly allows distant engineering via multiply connected spacetime, even inside the nuclei of distant objects. This is in fact a unique and marvelous engineering application and extension of Bohm's quantum potential concept.*

My "pinning" the electrons, apparently Fogal is able to essentially "hold" the vector potential and all the force fields while the instantaneous scalar potential *persists and now extends over all space, not just to the near field since all formerly moving field dynamics that would limit it have been frozen.* If this effect is substantiated, I have nominated it as the "Fogal effect". Further, this unrestricted instantaneous scalar potential now i lunges in field-free form (pure regauging form) over all space according to the signal energy being perpetuated and propagated<sup>136</sup> by the Fogal semiconductor independently of its pinned electrons. In this fashion, the **Fogal** semiconductor is indeed capable of "instantaneous" communication

<sup>136</sup> Here we again point out that the usual notion of a signal as energy propagating in 3-space is wrong. It propagates in 4-space, but not in 3-space. Also, what propagates is the spreading point-like polarization of the vacuum itself.

over essentially unlimited distances. At least one independent test has verified the Fogal instantaneous communication effect, but the test is still held proprietary by the testing agency.

Since Fogal is able to alter and control the internal longitudinal EM wave Whittaker structuring of the scalar potential used in this Coulomb gauge manner, he is able to accomplish superluminal (and even instantaneous) communication, so long as a Fogal semiconductor is available in both the transmitter and the distant receiver. In the transmitter, the Fogal component is necessary to *ifold* the information into the internal LW structure of the scalar potential to be used in the Coulomb gauge, thus transforming the input signal information into output longitudinal EM wave information directly in spacetime itself. The Fogal component in the receiver is necessary in order to detect, transduce, and *outfold* the infolded longitudinal EM wave information inside the instantaneous scalar potential. We have stressed that these internal longitudinal EM waves and their dynamics are spacetime curvatures and their dynamics. Hence their transmission and detection is a viable process for superluminal communication, including instantaneous communication.<sup>137</sup>

Further, once the electrons are pinned, all "signal fields in charged matter" (i.e., all EM force fields) are frozen and localized. This, we believe, involves a new physical effect introduced by Fogal that is analogous to the Aharonov-Bohm effect.<sup>138</sup> So I have called it the "Fogal effect". That is,

<sup>137</sup> We believe that physics books will have to be substantially rewritten, once the internal longitudinal structuring of the scalar potential (and of EM fields and waves) is employed directly in open technology. We further believe that the Fogal semiconductors are the first pre-developments in that coming vast new technology, at least in the open Western scientific world.

<sup>138</sup> There have long been, and still are, efforts to "fit" the Aharonov-Bohm effect into slightly modified classical electrodynamics after all. E.g., see C. J. Carpenter, "Electromagnetic energy changes due to charges moving through constant, or zero, magnetic field," *IEE Proc. A*, 138(1), Jan. 1991, p. 55-70; — "Electromagnetic energy and power in terms of charges and potentials instead of fields," *IEE Proc. A*, 136(3), 1989, p. 101-113; G. M. Graham and D. G. Lahoz, "Observation of static electromagnetic angular momentum in vacuo," *Nature*, Vol. 285, 1980, p. 154-155; T. H. Boyer, "Semiclassical explanation of the Matteucci-Pozzi and Aharonov-Bohm phase shifts," *Found. Phys.*, 32(1), Jan. 2002, p. 41-49; — "The Aharonov-Bohm effect as a classical electromagnetic-lag effect: An electrostatic analogue and possible experimental test," *Nuovo Cimento*, Vol. 100B, 1987, p. 685-701; — Classical electromagnetic deflections and lag effects associated with quantum interference pattern shifts: considerations related to the Aharonov-Bohm effect," *Phys. Rev. D*, Vol. 8, 1973, p. 1679-1693; — "Does the Aharonov-Bohm effect

the force-fields are frozen and localized by the pinning, but the field-free potentials then remain, including the instantaneous scalar potential  $\phi$  and probably the curl-free magnetic vector potential  $A$  as well. The result is that the instantaneous scalar potential can be directly *regauged* everywhere at once by the changes of magnitude of the "frozen fields", rather as if they were "static voltage", possibly simultaneously regauging the field-free  $A$ -potential — all as part of a new kind of Lorentz symmetrical regauging. After all, a single Lorentz symmetrical regauging {326} changes both the potentials  $A$  and  $\phi$ . Changes in symmetrical regauging produce stress waves, which are longitudinal EM waves. Continual changes of symmetrical regauging also continually changes both the potentials  $A$  and  $\phi$ , *including over all space when operating in the Coulomb gauge*. This is one explanation of the beautiful effect that Fogal has discovered and is utilizing.

We accent that, with pinned electrons frozen in place, the normal  $\phi$  and  $A$  in matter (defined in terms of interaction with charge and the movement of charge) cannot occur. With time reversal zone utilized, electron pinning is greatly eased and the instantaneous scalar potential  $\phi$  now assumes the primary active propagating role in surrounding space. Neither  $\phi$  nor  $A$  is free to develop the normal  $\partial\phi/\partial t$  and  $\nabla\times A$  *spatially propagating dynamics of the force fields (effect fields) observed in matter*. In the Fogal process, the instantaneous scalar potential "signal" (the causal signal in 4-space) is generated in the transistor when it pins the electrons and freezes the force fields into "equal and opposite" form. Since no net force field can develop, the instantaneous scalar potential is a stress potential in spacetime itself and simply changes its magnitude instantly, at each and every point in space that it occupies, when the Fogal chip's input EM fields change in its signal input.

In the output, the net force fields remain zero and frozen, even though the individual force fields change constrained to "equal and opposite" manner. If one wishes, one may take this part of the Fogal output — the field free changes in the stress energy density of the vacuum — as one expression of *modulating the instantaneous scalar potential's energy density in perfect correspondence to the field changes in the normal EM input to the Fogal transistor*.

**exist?'**. *Found. Phys.*, Vol. 30, 2000, p. 893-905; — "Classical electromagnetism and the Aharonov-Bohm phase shift," *ibid.*, p. 907-932.

The instantaneous Focal changes in magnitude (e.g., instantaneously induced upon a distant collecting charge) are no longer limited to near field effects, or to the speed of light — and communication is not bound to the retarded wave. Now the induced changes of the instantaneous scalar potential exhibit far field effects and these changes — being naught but these special Lorentz condition magnitude regaugings — are instantaneous. This of course is a form of *action at a distance*. We stress that the best astronomical evidence also points to a startlingly superluminal speed of gravitation (curvature of spacetime, which after all is just a longitudinal EM wave or set of them) itself, as pointed out by Van Flandern.<sup>139</sup> If so, since any change of energy in spacetime is a curvature of spacetime, and one form of spacetime curvature can move at superluminal velocity, so can other forms of spacetime curvatures. In our favorite expression, *it only takes one white crow to prove that not all crows are black*.

As is well known, the de Broglie waves of matter always move faster than light, as do appropriate quantum tunneling processes. Further, the quantum potential used by Bohm in his beautiful hidden variable theory of quantum mechanics {347} also appears instantly throughout space, wherever it will be, and with the value it will have. The question of whether a quantum potential can be used to communicate has been posed but not definitively answered in the previous literature. We propose a resounding "Yes!" if one uses the internal structure of the quantum potential for one's communication, applying some component such as the Focal semiconductor to do the infolding and unfolding.

We also propose that a process for forming and using an instantaneous scalar potential in the Coulomb gauge can be interpreted as the formation and use of a quantum potential or its direct equivalent. If that assumption is true, then the Focal semiconductor seems to be the first component ever openly built and patented which produces and uses Bohm's quantum potential, *including* its infolded Whittaker structuring and dynamics. It also definitively answers in the affirmative the question of whether the quantum potential and the scalar potential in the Coulomb gauge can be used in superluminal communications.

<sup>139</sup> Tom Van Flandern, "The speed of gravity - What the experiments say," *Phys. Lett. A*, vol. 250, Dec. 21, 1998, p. 1-11. Van Flandern gives an extremely important, clear, and succinct summary showing that experiments refute the standard far field assumption of light speed in gravitational effects. Laboratory, solar system, and astrophysical experiments for the "speed of gravity" yield a lower limit of  $2 \times 10^{10}c$ .

Thus Fogal has apparently found a way to directly modulate intelligent change of magnitudes into and upon the internal longitudinal EM wave structure of the instantaneous scalar potential (and upon the quantum potential), as well as iterative "pure *net-field-free*" regauging of the instantaneous scalar potential {327}. It seems to have previously escaped notice that varying the Lorentz symmetrical regauging of a circuit or system easily produces pure longitudinal EM waves. This strongly implies that Fogal has surmounted and removed the barrier to practical superluminal communication and even further has reduced the barrier to practical instant communication.

Several tests — in one of which the present author participated — have indeed shown Fogal transmission of signals, including video signals, between two widely separated points with less delay than light-speed signals exhibit, and also with video bandwidth infolded inside a DC signal. In at least one series of tests in a large company's own laboratory and by its own engineers, communications from a ground-based Fogal chip transmitter apparatus occurred between the ground station, through the uplink into the satellite, back through the downlink to earth, into a ground-based transmission system with repeater stations, and into the receiving Fogal transistor unit in the lab. The transmissions occurred with *no discernible time delay*, something previously deemed impossible in all the textbooks. This was particularly significant since even the conventional time-delays in the repeater station amplifiers and the satellite receiver-transmitters were apparently eliminated. This further accents that the infolded "longitudinal EM waves superhighway" inside all EM fields, potentials, and waves — including inside matter such as the ocean and the earth itself— is a multiply connected space phenomenon. It is the most ideal communication medium, enabling deep space communication without delay, etc.

**The** implications for nondelayed future remote control of robot spacecraft and robots landing on the surface of planets and asteroids are obvious, as are the implications for direct exploration and measurement of conditions *inside the interiors* of the planets, the sun, the moon, and the earth via **internal** scalar interferometry. We accent that Fogal has done private experiments exploring this vast new physical reality revealed by the "internal longitudinal EM wave dynamics" and its interferometry, and it is mind-expanding (some would say *mind-boggling!*). It is also a great new step in physics and in our very notion of physical reality itself.

**The** vacuum itself, being highly energetic, is indeed a scalar potential. **Further**, it has any and all gauges. Since potentials superpose, we postulate

that Fogal's use of the instantaneous scalar potential is directly superposed on the corresponding instantaneous Coulomb gauge scalar potentials of the entire vacuum. His discovery of how to modulate the instantaneous  $\phi$  magnitude without allowing modulated EM field propagation, constitutes a very special case of tunneling right through "space" itself, using one aspect or "component" of space.

In short, to be a little dramatic one might even apply the term *subspace communication* to this long distance tunneling effect. That interpretation would also seem consistent with the deterministic variation of the internal stress energy density structuring of the vacuum that is produced in the Fogal process.

From another viewpoint, Fogal has succeeded in not only finding the missing chaos of quantum mechanics, but in deterministically engineering and using it.

This is also consistent with Whittaker's decomposition of the scalar potential into bidirectional longitudinal EM waves {328} and his connection between time-polarized EM waves and longitudinally polarized EM waves as reinterpreted (12) to be consistent with quantum field theory {19}. We point out that a single point in time is simultaneously "connected" to every point in the universe. By using a transmission system that back-pedals from 3-space into the time domain, an instantaneous connection to any other spatial point in the universe is therefore available, if one's technology can take advantage of it. Fogal's technology does.

It is also consistent with quantum tunneling experiments that have demonstrated the transmission of intelligent signals (such as Mozart's 40th symphony) at superluminal speed between two points in a waveguide {329a-b}. Regardless of how one chooses to model intelligent superluminal communication, it has been experimentally demonstrated — multiple times and by multiple experimenters in multiple laboratories — that such can occur.

The difference in those superluminal experiments and the performance of the Fogal chip is that the chip uses iterative regauging of the magnitude of the instantaneous scalar potential, as well as deterministic alteration of the scalar potential's internal longitudinal EM wave substructuring, and probably also modulates the internal structuring of a quantum potential. The presently proposed quantum tunneling mechanisms apparently do not do this, at least as they are presently modeled. Further, the quantum tunneling mechanism is difficult to apply; the Fogal mechanism is fairly

simple and straightforward to apply, given the Fogal semiconductor at both the transmitting and receiving ends of the communication system.

Pure longitudinal EM waves readily penetrate matter to great distances, since matter is mostly empty space between widely separated mass particles. On the microscopic scale, matter is comparable to something like the solar system, except that intense fields and potentials (bundles of longitudinal EM waves and their dynamics) occupy the space between the particles. All this vast empty space inside matter, being a potential and comprised of longitudinal EM waves, is a giant "superhighway" for the passage of longitudinal EM waves and their dynamics, as indeed is matter itself which is mostly such empty space. Further, even the masses themselves are such, since mass is simply highly compressed spatial energy density, and therefore is highly compressed longitudinal EM wave energy and dynamics. It is just a "denser" superhighway.

Hence a longitudinal EM wave system can readily be developed to "see through matter" using Fogal semiconductors in transmitter and receiver. Fogal in fact has made at least one proprietary prototype demonstration unit that demonstrates this startling capability. The vision is very clear, due to the remarkable absence of noise in the Fogal process. It is also shockingly unique, and it changes our very notion of physical reality. We are not at liberty to further discuss this new "sub-submicroscopic" reality revealed in such experiments. We simply interpret it as jumping the presently assumed restrictions of observation, and allowing the direct or correlated observation of the virtual state entities.

As alluded to, the previously modulated "Fogal type signals" emitted by all matter and other physical entities can also be displayed on a screen using the Fogal process, revealing a hitherto unsuspected physical reality and EM signals environment. In this prototype system, Fogal showed a remarkable and startling new extension of our very perception of physical reality itself. This is another reason why we expect that physics books will have to be rewritten, once the Fogal semiconductors are on the market and available in practical equipment. As every physicist knows, any dramatic increase in our ability to sense finer levels of physical reality inevitably leads to new and startling advances in physics itself and changes our very knowledge of the nature of physical reality.

The ability to bypass and "park" force fields by pinning their source electrons in a time-reversal zone, while continuing the flow of noise-free EM energy at will and at infinite velocity, obviously enables  $COP > 1.0$  systems. A pure longitudinal EM wave already has infinite energy, for

such a wave appears across the entire universe simultaneously, instantly changing the stress energy density of the entire vacuum in which the longitudinal EM wave is present.<sup>140</sup> The back emf and back mmf fields in an EM system or electrical power system can be frozen and held from restoring the Lorentz condition in the circuit, using the Fogal semiconductor {330}. We presently have an agreement with Fogal for the licensed use of his semiconductors in all such energy unit applications.

A quantum potential is modeled in a multiply connected spacetime, so that a given joule of input energy to one multiply connected point simultaneously appears in every other multiply connected point.<sup>141</sup> Since the Fogal semiconductor apparently can operate in quantum potential or Coulomb gauge fashion, it can act as a *direct energy amplifier*, with respect to the lab observer in a singly connected space. In short, the Fogal process dramatically extends the concept of "conservation of energy" to include conservation in multiply connected space and therefore incorporates observed energy amplification in singly connected space. Again, a broken symmetry (in singly connected space) reveals a higher symmetry (in multiply connected space), and the hierarchy principle is alive and well. In short, with the Fogal semiconductor used in power systems, the law of conservation of energy must be extended to include energy symmetry in multiply connected space but asymmetry in singly connected space. Obviously, such functioning totally transcends the limitations of the present thermodynamics models.

We carefully point out that this is not "energy creation" but simply the energy following the known kind of statistics in physics that allows a thing to be in multiple different places simultaneously. What is actually "instantly transmitted" is the simultaneous regauging of the energy density of the vacuum. At any point in space, the vacuum has an energy density and thus is a scalar potential with a given magnitude. Changing the energy density is simply regauging, which is freely permitted under the gauge freedom axiom of quantum field theory. So instant amplification of

<sup>140</sup> This should not be too surprising, since the bare charge and the bare mass of every electron each has infinite energy, as is well known in particle physics. For confirmation in very straightforward language, see Nobelist Steven Weinberg, *Dreams of a Final Theory*, Vintage Books, Random House, 1993, p. 109-110.

<sup>141</sup> If we wish, we can even take time itself as a special kind of quantum potential, since time also displays such a "multiplicity of connection" in 3-space. In one sense, time is the ultimate quantum potential, since a single point in time is "connected" to every single 3-space point in the universe, simultaneously.



energy" over a region of points is simply the instant re-gauging of the potential already present at each point in the region. It is a *permissible multiply connected space violation* of the present more limited "special case" energy conservation concept, which implicitly assumes a singly connected space. We have been working with Fogal for some time in this area, and we expect to rapidly develop and introduce commercial EM power systems based on the Fogal semiconductor's abilities in multiply connected space, as soon as it is in production and available. Until then, the details of our work in that area must remain highly proprietary.

#### 5.8.4 Point-Contact Transistor.

Figure 5-8 diagrammatically shows a point-contact transistor with n-type base in a typical circuit for power gain. The point of the contact is under pressure on the material with which it is in contact.

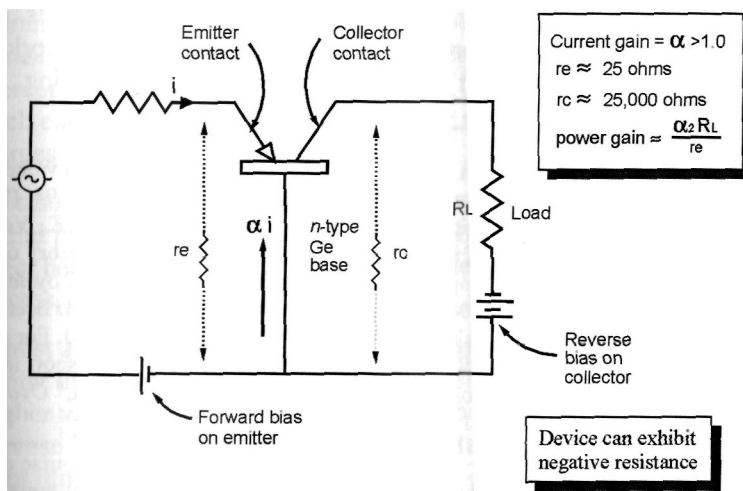

Figure 5-8 Point contact transistor with n-type base.

The point-contact transistor often behaved in true negative resistor fashion, outputting more energy than was input to it. Its production was always far **more** of an art than a science.

As can be seen from our quotation at the beginning of this chapter, the original point-contact transistor was never thoroughly understood

technically.<sup>142</sup> Specifically, there does not appear to have ever been any deliberate attempt to capitalize on the ability of the transistor to become a true negative resistor under certain manufacturing techniques and under certain conditions.<sup>143</sup> Instead, the variations and difficulties in manufacture resulted in use of the point-contact transistor being essentially bypassed rather quickly, by advancing to other transistor types more easily manufactured and with less manufacturing variances. In reducing the manufacture of other types of transistors to a science rather than an art, the point-contact transistor and its further development and optimization into reliable true negative resistors were abandoned.

We present this transistor as a straightforward and relatively inexpensive area in which young researchers in COP>1.0 systems and phenomenology may wish to begin, assuming they have access to semiconductor facilities in a university or similar or are willing to work meticulously under a jeweler's loupe. A rich combination of effects in the transistor awaits optimization and control. We predict that we shall yet see, on the world market of the future, such point contact transistors reliably exhibiting

<sup>142</sup> E.g., different theories are given in: (a) W. Shockley, "Theories of high values of alpha for collector contacts on germanium," *Phys. Rev.*, Vol. 78, 1950, p. 294; (b) W. R. Sittner, "Current multiplication in the Type A transistor," *Proc. I.R.E.*, Vol. 40, Apr. 1952, p. 448-454. Also of interest is (c) W. van Roosbroeck, "Theory of the flow of electrons and holes in germanium and other semiconductors," *Bell System Tech. J.*, Vol. 29, Oct. 1950, p. 560-607. See also (d) J. Bardeen and W. H. Brattain, "The transistor, a semiconductor triode," *Phys. Rev.*, Vol. 74, 1948, p. 230. For a more modern re-examination, see Shuji Hasegawa *et al.*, "Electronic transport at semiconductor surfaces — from point-contact transistor to multi-tip STM," *Oyo Buturi*, 70(10), 2001, p. 1165-1171 (in Japanese).

<sup>143</sup> E.g., the point contact is usually under pressure, and this pressure of course can be varied. The full phenomenology of points (which increase voltage) and pressure, complicated by surface effects as well, has not been worked out in physics. Note the similarity of the pressure in the point contact transistor to the pressure in the Chung negative resistor. Note the almost certain involvement of the "overpotential" of chemistry and electrode chemistry, as well as the "double surface" effect of the small gap between the point and the substrate on which it rests in contact. Part of the gap probably even involves the Casimir effect as well. Any electrical signal variation in that very complex point junction will vary the overpotential, the stress potential, the "point increase in voltage" effect, etc. As can be seen, the phenomenology of the point contact is remarkably complex and rich in several areas of physics and in a great variety of physics variables. Obviously, the reasonable control of all these highly nonlinear variables — and their mutual interactions — is a difficult matter. Hence the readiness with which point contact transistors were dropped with substantial sighs of relief.

negative resistance. It will be necessary, however, to also take into account the symmetrical self-regauging characteristics of the common closed-current-loop circuit. By adroit switching of a true negative resistor in and out of a closed-current-loop branch, or placing it in parallel with the back emf of that branch to reduce it, asymmetry can be introduced into the overall closed current loop circuit, defeating the Lorentz symmetrical regauging. Defeating the Lorentz condition is essential to  $COP > 1.0$ , of course.

We envision such a development as an ideal "negative resistance shunt" to add across the secondary of a transformer, and another possibly across its primary and across the external power supply as well, in producing more amenable and easily fabricated  $COP > 1.0$  electrical systems. We also point out that, once the back emf or back mmf forcing of equal power dissipation in the primary of a transformer or in the emf section of a circuit is dramatically reduced or eliminated, one does not require "large intensity" potentials and voltages to collect a great deal of power in the intercepting and receiving external circuit. Again, by simple  $W = Vq$ , as much energy  $W$  can be collected from any nonzero potential  $V$  as there are charges  $q$  to intercept.

We also envision such a true negative resistor being close-looped by the Bedini process, thus producing a small "self-powering" transistor, which in effect becomes a small self-powering "battery". This is absolutely a doable process, and it will be done once the Fogal semiconductor is in production.

Almost all semiconductor materials are also optically active materials, and a point discharge into such materials represents a very sharp regauging (higher voltage) discharge at a point or into a very small area, due to the increase in potential at the tip where it contacts the base material. The point junction is under pressure, so a stress potential exists there. In addition, the well-known "point" effect also increases the potential in the junction pointer itself, from its base to the point. The point contact phenomenology of different materials — one conductive and one semiconductive — is of much interest, and with novel phenomenology.

The fact that the point-contact transistor in its most usual formulation primarily uses holes more than electrons, is also of much interest in  $COP > 1.0$  situations. Holes in a circuit move against the voltage. The trick is to let the Dirac holes *before observation* move in an open path from the ground return line against the back emf to the potentialization line, and **transduce** the moving hole current (via the Bedini process) into electron

current after the holes have already freely reached the vicinity of the high side of the circuit.

When Dirac sea holes (causal positrons before observation and thus prior to their alteration to lattice holes and parity reversal) and Dirac sea hole current are also involved with point-contact transistors, the resulting phenomenology has been but little investigated and none of it is in the present textbooks. However, from recent work with positron probes and positron microscopes to examine semiconductors and semiconductor materials, it is known that the holes (positrons) tend to be repelled from nuclei in the material into defects (voids) in it {331}. These effects have been investigated, for example by Triftshauser *et al.* {332}.

Both the mechanical stress potential (which is fundamentally electromagnetic) and the heightened junction potential decompose via our reinterpretation of Whittaker's 1903 decomposition of the scalar potential. This leads to optical-type pumping in both the time domain as well as the 3-space domain. Hence novel optical-type effects and time-reversal of material states can be involved, leading to a very complex set of phase conjugate phenomena, time-reversal phenomena, etc.

Certain Hall effects employed in conjunction with a point contact transistor could be a fruitful area of investigation. As an example, narrow Hall bars with junctions between current and voltage leads of various geometries could be investigated. Widening the junction from the normal square-cornered shape can sometimes produce a negative Hall resistance.

*The junction* of the point contact involves asymmetrical self-regauging, iterative time-reversal retroreflection, increased Poynting and Heaviside energy flow components, optical scattering processes inside the junction materials, etc. The transistor can indeed be manufactured so that these highly nonlinear effects sum to a negative-resistor-like movement of the output current against the voltage, although with so many other phenomena involved it will require some hard work and research in order to develop and stabilize it — and understand it.

### **5.8.5 Bedini's Negative Resistor Process in a Battery {333}.**

#### *5.8.5.1 Some Pertinent Lead-Acid Battery Processes*

A lead-acid storage battery is a highly nonlinear device. The plates may be plante, pasted, or tubular etc. They are usually highly porous and have a thin oxide layer. They may have other coatings and the electrolyte solution may include additives to enhance operation. The plates consist of a mix of crystalline materials in most cases. The plate materials include acicular

(needle-like) crystals, particularly the negative plate. The plates usually are porous, knit, and have gridded separators.

The chemistry of the battery electrolyte is complex and — even today — not all of it is well understood, particularly when mass transport is accounted. In our discussions, we will be including some of the previously neglected phenomena during mass transport (ion sluggishness in moving) that are responsible for some of that lack of understanding. In the battery chemistry, there are many double surfaces between the ions and also there is a variety of point voltages. There is a separate theory for double surfaces.

One of the most important phenomena is that the ion currents in the electrolyte are confined to the battery, and do not pass out into the external circuit. Much of the electron currents in the external circuit are blocked at the plates from moving within the electrolyte. Consequently, we will limit our discussion to two major currents of interest<sup>144</sup> in a battery-powered system, and these currents are effectively isolated from each other (at least to first order). Those currents are (i) the ion currents in the electrolyte, confined to between the plates and therefore internal to the battery electrolyte, and (ii) the electron currents between the outside of each plate through the inside of the plate and on out through the external circuit and **then** around to the inside and thence to the outside of the other plate. Chemical changes occur on the plates themselves as a result of these two currents.

It is usually assumed in power systems that these two currents are in phase or almost entirely so. That need not be true at all, and Bedini takes specific advantage of deliberately arranging these two currents to be antiphased part of the time. Part of the Bedini effect can be understood from this fact alone; the other part must consider one other most unusual electrical current that is encountered only in battery-powered systems or COP»1.0 systems.

So indeed there are *several* (many) currents in a lead acid battery [334], not just one, and we will consider three of them — the two previously mentioned, and an additional Dirac sea hole current in the local vacuum **itself**. The reader interested in greater technical depth should also turn to

<sup>144</sup> Of course, there are many other currents in a battery as well, but — although an oversimplification — these two major currents together with the Dirac sea hole current will suffice for our introductory modeling and explanation purposes.

the literature of electrode chemistry and electrochemistry {335a-f}, which is quite complex.

#### 5.8.5.2 Dirac Sea Hole Current

In a battery-powered COP»1.0 system (and in some COP>1.0 systems), there is a previously unrecognized significant flow of Dirac hole current in the local vacuum, running from the output section of the system to the system input section and thence through the conductors into the battery terminals and onto the battery plates, and on into the battery electrolyte chemistry. This hole current may be greater — *evenfar* greater — than the normal electron current running from input to output.

So in the battery-powered overunity system with positive feedback, not only does an electron current run from the battery through the connecting conductors to the input section of the system, but also a Dirac hole current pours back out of the system input section, and — if not intercepted and transduced — through the conductors and back into the battery. All the while, this Dirac hole current is "eating" electrons being furnished by the battery to the system. The net result is that the battery "sees" an extra load to be powered, in addition to the ordinary load presented to it by the normal system input section. It "sees" the situation as an "extra load" because it first has to furnish sufficient electron current to fill the hole current and "kill" it, before it can furnish the additional electrons to power the system in normal fashion.<sup>145</sup>

<sup>145</sup> An odd effect occurs in the battery, however, when the battery completely discharges in the normal sense. Actually, it is still fully charged with positive energy charge, but also has been simultaneously charged with negative energy charge. With the excess negative energy holes continuing to charge the battery with negative energy charge, the battery becomes increasingly *charged with net negative energy*. There is almost no limit to the negative energy charge the battery (i.e., the local Dirac vacuum portion of its supersystem) can take, except the eventual development of antigravity effects due to the inverse and increasing curvature of local spacetime in which the battery is embedded. After a battery has been used to power a COP»1.0 system for some time, one can take the battery off, place it on a normal battery charger, and it will then "eat" positive power for an extended period of time — e.g., a week or longer. During this period, one is steadily negating the inverse curvature of the local vacuum via the increased positive energy collecting in that spacetime. The battery again finally passes through zero voltage and net charge again, and suddenly starts charging up again in a "normal" sense with positive energy charge. This process actually increases the lifetime and function of a battery in a startling manner. Bedini has used batteries almost devoid of charge and energy in the normal sense, and powered systems very well with them, even for longer than a year continuously.

A  $COP \gg 1.0$  EM system is an excited system far from equilibrium in its exchange with its active environment. For all such excited systems, there exist significant decay mechanisms to bring the system back into equilibrium with its environment, since equilibrium yields the lowest energy state and maximum entropy. The Dirac sea hole current (negative energy current) is nature's unexpected natural decay mechanism to sharply decay a  $COP \gg 1.0$  system back to an overall  $COP < 1.0$  system when the external power supply is considered also.<sup>146</sup>

So when Dirac hole current back through the local vacuum and through the system is involved, the battery first has to furnish electron current to fill these holes at the rate they are appearing in the input section, thereby furnishing a primary "hole-filling" electron current component which "disappears" into the Dirac vacuum and is lost.<sup>147</sup> Only after the holes in the hole current are filled — and the hole current is being steadily nullified

<sup>146</sup> It decays the *true negative resistor* power system back into being only a *differential negative resistor section* of a slightly extended metasystem including the power system and its external power supply. This novel decay mechanism also prohibits close-looping the now differential negative resistance power system for self-powering, unless the hole current is first converted into electron current, as discussed in Chapter 9 and in paragraph 4.9.6 below.

<sup>147</sup> The filling of these Dirac sea holes is not pair annihilation in the usual sense, and no radiation is emitted. Instead, the energy of the radiation that would otherwise be emitted is added to the negative energy curving the spacetime. Hence the net curvature of spacetime relaxes because of superposition. In effect, the vacuum/spacetime itself reabsorbs the energy as relaxation spatial energy added to the curvature energy of the curved spacetime, reducing that curvature. Particularly see Mendel Sachs, *Quantum Mechanics from General Relativity: An Approximation for a Theory of Inertia*, Reidel (now Kluwer), 1986. A generalization of quantum mechanics is demonstrated in the context of general relativity, following from a **generally** covariant field theory of inertia. Nonrelativistically, the formalism corresponds with linear quantum mechanics. In the limit of special relativity, **nonlinearity** remains and several new features are derived: (i) Particle-antiparticle pairs do not annihilate; an exact bound state solution is derived corresponding with all experimental facts about annihilation/creation — which, in approximation, gives the blackbody radiation spectrum for a sea of such pairs, (ii) A result is proven, without approximation, that is physically equivalent to the Pauli exclusion principle — which in linear approximation gives the totally antisymmetrised main-body wave function and Fermi-Dirac statistics, (iii) The hydrogen spectrum is derived, including the Lamb shifts, in agreement with experiment; new results are found for **high-energy** electron-proton scattering, (iv) Finally, several applications to the elementary particle domain are demonstrated, in agreement with results from experimental high-energy physics.

— can the battery then send additional electrons which do not disappear and which are accepted in the system input section to power the system. We discuss this Dirac hole current in some detail in Chapter 9, including how to convert it into useful input electron current to the system, reducing the current load on the external generator and enabling self-powering. Bedini invented the method of transducing available negative energy hole current in the vacuum into electron positive energy flow to charge the battery and power the system, preventing decay of the  $COP \gg 1.0$  system back to  $COP < 1.0$ .

We shall not discuss the complexity of the additional chemical reactions ongoing in the battery electrolyte and on the plates. The two main mass-containing currents and the negative energy Dirac hole current will suffice to explain the Bedini negative resistor formation and usage, at least to first order and sufficient to stabilize systems.

### 5.8.5.3 *Changing Symmetrical to Asymmetrical Regauging*

To first order, we reiterate that the electrons flow from one plate of the battery through the external circuit to the other plate, but the lead ions do not. There is thus a sharp "two separate currents" interface at the plates and thus a sharp separation between the electron current and the ion current. In short, there are actually two half-circuits in the battery-powered system if one chooses to use them semi-independently.

The current carriers in the two half-circuits are quite different. Therein lies the opportunity to separate and antiphase the two currents, using one to recharge the battery while the other is used to power the loads. It also allows a good opportunity to asymmetrically regauge both half circuits, greatly and freely increasing the Poynting energy component intercepted, collected, and used by each half-circuit's carriers. This is the basis for a profound "opening" of the system and influx of excess vacuum energy.

The two half circuits meeting at a common interface allow a stress potential upon that interface to *individually* use the two halves of what is normally Lorentz's symmetrical regauging. That usually *symmetrical* regauging (if the complete circuit were unitary) is now comprised of two separated *asymmetrical* regaugings, one for each of the two circuit halves, because the net stress potential (net Lorentz symmetrical regauging) — consisting of two opposing fields and forces — is split into two now-individually-separated and separately utilized force fields.

We accent this process by an analogy. Suppose we suddenly place a scalar potential  $\phi$  upon a point in the middle of a transmission line. Immediately the potential  $\phi$  races off (spreads) in both directions simultaneously, at



nearly light speed. Further, in each direction there is a moving gradient of  $\phi$ , hence an E-field by  $\mathbf{E} = -\nabla\phi$ . These E-fields or "emfs" are oriented in opposite directions, so there is a movement of charge from the middle of the line toward each of the ends. The same "dephasing" current effect can be applied to any conductive medium or to the interface between two conductive circuits.

In Bedini's negative resistor case, the placement of the potential  $\phi$  — for its movement in both directions — is on the interface (the face of the lead plates) between the two half circuits and therefore between the two different current carrier types. An initial "Lenz's law" reacting with the suddenly placed E-field onto the plate surface, creates an E-field in opposition, forming a stress potential  $\phi$  which is much higher than the normal potential of the battery (in a nominal case, 100 volts instead of the 12 volts of the battery).

Immediately this potential "takes off in both directions", with a powerful E-field and emf back into the outside circuit and its load, while a powerful E-field and emf also proceed into the battery electrolyte in the opposite direction. So the ions in the battery have a sudden, much higher energy interception and collection forced upon them, with the excess emf now being in *battery-charging mode*. The electrons in the outside circuit simultaneously have an excess emf and potentialization in the *load-powering mode*. Let us see how the two very different current carriers react to these "dual emfs" in the overall circuit.

#### 5.8.5.4 *Mass-to-Charge Ratios of the Two Current-Carrier Types*

We stress the dramatic difference in the *mass-to-charge (m/q) ratio* of the two currents. The lead ions' m/q ratio is some few hundred thousand times the m/q ratio of electrons, as we recall. For our purposes, all we need to know is that the m/q ratio for the lead ions is *very much larger* than the m/q ratio for the electrons. For a given force, the ions in the internal half circuit in the electrolyte will therefore respond very much slower than will the electrons in the external circuit half.

#### 5.8.5.5 *Hysteresis Between the Responses of the Two Half-Circuits*

Because of this great disparity in the m/q ratios of the two mass currents, there is obviously a relatively significant hysteresis (time delay) between the *response* of the more massive ion current and the *response* of the far **less** massive electron currents that interact at the plates to try to change the ion current and its momentum. This time-delay between ion response in the electrolyte (the effect) and electron pileup urging (the cause) can be adroitly manipulated. Specifically, it can be used to alter the local vacuum

potential and cause it to add excess energy to the ions in charging mode **and** simultaneously to add excess EMF to the electrons in circuit-powering mode. In short, the response delay can be manipulated to "asymmetrically regauge" the mass currents in the system, freely changing their potential energy, and dramatically increasing how much potential energy is available for battery recharging and how much is available for powering the external circuit (loads and losses). Further, during the antiphase condition of the two current halves, the battery can be charged simultaneously while the external circuit half and load is being powered. Excess energy is fed into both actions by the *overpotential* (the stress potential) created at the surface of the plates.

#### ***5.8.5.6 Evoking the Initial Bedini Negative Resistor Effect***

Figure 5-9 shows the first phase of Bedini's negative resistor process. Consider the battery in normal load-powering operation. From the external circuit, a very sharp leading edge rise of a pulse of electrons and potential is sent to the battery plates in "back-popping" or "battery charging" mode. The back-popping electrons drive in nearly instantly, piling up on the negative plate<sup>148</sup> and trying to force the heavy ions to start moving in the battery recharging direction. The pile-up that results in the stopped electrons on the battery plate surface represents an increase in local current density, hence an increased potential. This produces the 100 volts potential, during the time that the ions have not yet responded to any appreciable degree.

Due to much larger  $m/q$  ratio of the sluggish ions for a moment they lag due to their greater inertia, and this allows the much more agile electrons to "pile-up", producing a substantial overpotential as the local current density increases. The lagging ions are being steadily overpotentialized during this "lag time", up to about 100 volts in a normal 12-volt battery. At the same time, electrons are being forced back out of that higher 100-volt area and into the external circuit and its load, which had been at 12 volts. Recall now that these electrons can move longitudinally only at the drift velocity. Hence all electrons in the external circuit are now highly overpotentialized, and in *load-powering mode*. The overpotentialized electrons are thus producing excess power in the external circuit, much more than normal.

<sup>148</sup> We are not using conventional "positive current and positive plate" as the high side of the potential. We are using "electron current and the negative plate" as the driving potential plate.

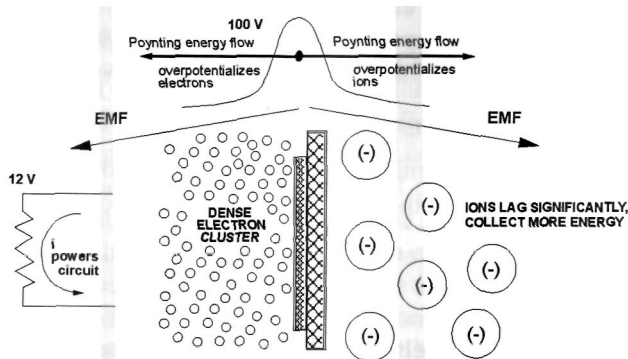

- 1 Sharp leading edge voltage pulse produces intense electron clustering and large potential (negative resistor) at interface. Sluggish ions only beginning to move
- 2 Bidirectional Poynting energy flow from potential overpotentializes both the electron cluster and the ions, which are only beginning to move in charge mode
- 4 Large back emf into circuit returns overpotentialized electron current, powering circuit with excess energy pouring from negative resistor potential. Continues during ion delay
- 5 Simultaneously overpotentialized ion current is overcharging battery

Figure 5-9 Phase I of the Bedim negative resistor process in a storage battery.

Then the overpotentialized ions very slowly (compared to the electrons!) slow, stop, and begin to move in the opposite direction. They reluctantly respond and move in *battery recharging mode*. During that ion-response lag time, and the slower initial portion of the response, the electrons in the pulse continue to furiously surge in and pile-up on the negative plate, overpotentializing both the ions and the external circuit's electrons, while also some of them are being impelled back out into the external circuit to power it with extra overpotentialized energy dissipation. The charge density at that plate sharply increases due to the pile-up where the charges are "squeezing" together (clustering). There is a much higher potential suddenly rising in the squeezed charge cluster, because of the increased charge density there. As we stated, this potential nominally may be about 100 volts during this initial phase.

We call attention to the simple equation  $W = VQ$ , where  $W$  is the potential energy added to charges  $Q$  exposed to voltage  $V$ .

Simplified, the excess energy  $W_{IONS}$  freely impressed upon the ions is

$$W_{IONS} = f(100 - 12)(Q_{IONS}) \quad [4-3]$$

where  $Q$  is the total coulombs of charge of overpotentialized ions and  $f(100 - 12)$  is the magnitude of the overpotentialization of the ions.

At the same time, an excess energy is impressed upon the electrons in the external circuit by the same potential extending along the conductors into the external circuit. Again, this excess energy  $W_E$  is given by

$$W_E = f(100 - 12)(Q_E) \quad [4-4]$$

where  $Q_E$  is the total coulombs of charge of the overpotentialized electrons and  $f(100 - 12)$  is the magnitude of the overpotentialization of the electrons.

But the emf on the electrons from the pile-up is directed in load-powering direction, as can be seen. Consequently the ion current and the electron current have been deliberately dephased by  $180^\circ$ , and so the overpotential energy of the ions is delivered in battery-recharging mode, while the overpotential energy of the electrons is delivered in circuit load powering mode.

Recapitulating: Pulsed pile-up of excess electrons on the negative plate interface between the two currents, while the ions are beginning to respond or only sluggishly responding, produces a much higher potential (an *overpotential*) on the sluggish ions — nominally some 100 volts in a 12-volt battery. On the negative plate, momentarily there is now a much higher voltage (with respect to the positive plate) than normally exists in the 12-volt battery. This voltage *overpotentializes* both the reluctant charging ions in the battery solution between the plates, and the powering electrons back into the circuit in powering mode due to the reversal of the emf. Since there is, say, 100 volts across the battery momentarily, there is also 100 volts now across the external circuit momentarily. Accordingly, overpotential excess powering of the external circuit load is suddenly evoked, while at the same time overpotential recharging of the battery is also evoked.<sup>149</sup>

In short, the ion current in the battery and the electron current into the external circuit have been placed  $180^\circ$  out of phase, achieving one major requirement for a  $COP > 1.0$  electrical system: *violating the integrity of the closed current loop circuit*. The battery is recharging at the same time that

<sup>149</sup> Another of Bedini's innovations is to shunt the excess voltage (say, above 14 volts) into an external capacitor on the circuit side. In that way with his overpotential he can be (i) overcharging the battery, (ii) powering the load, and (iii) storing excess energy in that capacitor, from the altered vacuum — all simultaneously.

the external circuit is being powered, *from the same free overpotential*, and both recharging and circuit powering are driven by increased emf.

We strongly accent that the overpotential at the plates represents a change in the local vacuum potential, and it *identically is* part of that now-altered local vacuum potential. The vacuum, since it contains enormous EM energy in virtual state, is a very powerful EM potential. Any EM potential in our circuits is automatically a change to the ambient vacuum potential, or a change to another potential that is such a change to the vacuum potential. In the most exact sense, this is a method of overpotentializing the plate interface with excess energy from the vacuum, and then letting that energy flow onto the ions to recharge the battery and onto the electrons in the external circuit to power it and its load.

The Bedini overpotential at the battery plates decomposes via Whittaker 1903 {85} as reinterpreted and previously explained, so that excess energy is entering 3-space there, *from the time domain*. Further, the piled-up electrons on the plates and the ions (as charges) in the solution receive such potential energy from the increased potential on them via the same decomposition process. So the creation of the Bedini overpotential on the battery plates, together with dephasing the two currents, is the creation of a true negative resistor at the plates, freely receiving energy from the external vacuum (from the time domain and virtual state) and transducing it into real potential energy and emf on the internal ions and on the external circuit electrons.

Hence Bedini has invented a process for creating a true negative resistor inside a storage battery, and for suddenly thrusting the system out of equilibrium with both the active local vacuum and the active local curvatures of spacetime. As such, the thermodynamics of open systems far from thermodynamic equilibrium applies, and that system is permitted to exhibit  $COP > 1.0$ , while complying with energy conservation and the laws of physics and thermodynamics. With adroit use and collection of the excess energy, the externally collected energy can be used to close-loop the system and power all its functions. So the system is permitted to power itself and its loads, with all the energy being received from the vacuum via the broken symmetry created. Any overpotential is a dipolarity *a priori*, since any potential is. Hence creating an overpotential is precisely producing an extra broken symmetry of that dipolarity right there at the interface between the two half-circuits and the two dephased, localized currents.

During the "back-popping" pulse signals, one should not think of the energy pulses that Bedini inputs to the battery as the "powering" energy. Instead, one must think of each pulse as "triggering" and "timing" energy which initiates certain other key *negentropic* interactions to freely occur, once the electron pile-up occurs. The resulting negentropic interactions then add substantial additional energy (from the local active vacuum) to the ions in the ion current and to the electrons in the electron current. The freely added energy can be appreciably more than the switching or triggering energy that is dissipated as the "input by the operator".

In short, Bedini deliberately "switches" and "triggers" certain kinds of vacuum exchange interactions, effectively creating a *true negative resistor* in the battery itself.<sup>150</sup> Due to the broken symmetry of the increased dipolarity (*overpotential*) that Bedini makes in "electron pile-ups" urging reluctant and delayed ion response, the vacuum furnishes extra virtual particle flux to this pile-up of electrons on the plate, which produces an enhanced Poynting energy flow that interacts with the ions in the battery electrolyte. Being charges, these ions thus transduce some of the excess absorbed virtual photon energy into real observable energy, thus increasing their potentialization and energy.

Bedini's method does the following: (i) It forms a true negative resistor in an unexpected way, upon the plates between a pile-up of electrons and the ions in solution in a common lead acid battery, (ii) it uses that negative resistor to extract excess energy from the vacuum and furnish it both to the ions forced into charging mode and simultaneously to the electrons in load powering mode, and (iii) it adds several other stimuli (such as Lenz law effects) which further amplify the negative resistor and enhance the effect, increasing the excess energy extracted from the vacuum and collected in the battery-charging process and also in the circuit-powering process simultaneously.

Specifically, the delay in ion response is adroitly allowed for and manipulated by Bedini to place the battery in ion current recharging mode while the signal pulse electrons between the plates and the external circuit are simultaneously placed in external circuit powering mode. By manipulating the hysteresis and adroitly timing the electron pulses and pulse widths, *Bedini breaks the usual forced Lorentz symmetry of the excitation discharge in a usually closed current loop containing both the*

<sup>150</sup> Again we stress that any dipolarity or potential is a negative resistor, producing giant negentropy {12}.

*battery's source dipole and the external load.* This is possible since his method deliberately opens the system so that vacuum energy enters freely, increasing the potentialization (energy collection) of the ions in the battery solution and upon the electrons between the plates and the external circuit as well.

We stress that Bedini has chosen to *avoid the* usual dissipation of half the energy collected in the external circuit to do nothing but kill the source dipolarity between the battery plates. He works on "that half of the circuit" that is usually just called the "back emf region" and ignored, and he separates and dephases that half of the circuit from the other half. By interrupting that normal "back emf battery-discharging section dynamics and converting it to "forward emf battery recharging section dynamics, while simultaneously powering the external load, Bedini temporarily produces and utilizes a negative resistor right there on the surface of the battery plates themselves.

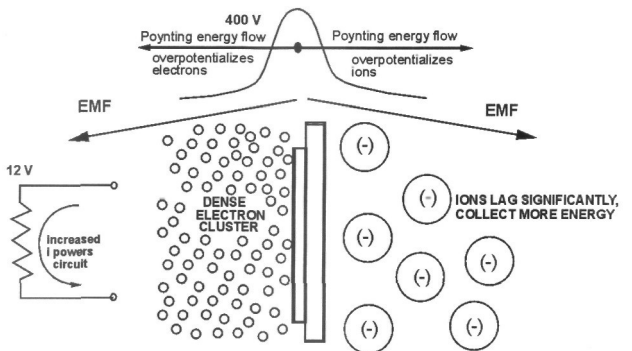

- 1 Sharp trailing edge of voltage pulse produces intense Lenz law effect. Sharply increases electron clustering and potential (negative resistor) at interface. Sluggish ions delay speedup further increasing the Lenz law effect
- 2 Increased bidirectional Poynting energy flow from potential overpotentializes even further both the electron duster and the ions, which are only beginning to accelerate in charge mode
- 4 Large new increased back emf into circuit returns overpotentialized electron current, powering circuit with new excess energy pouring from negative resistor potential. Continues during ion delay
- 5 Simultaneously, re-overpotentialized ion current is overcharging battery even faster

Figure 5-10 Phase II of the Bedini negative resistor process in a storage battery

#### 5.8.5.7 Further Increase of the Negative Resistor Effect by Lenz's Law

See Figure 5-10. To further increase the Phase I effect just before it would end, and requiring precise timing of his switching of the pulse leading edge and trailing edge, Bedini then invokes a second phase by carefully controlling the timing for the sharp *cutoff* of the "stimulus pulse" creating the negative resistor. This is usually invoked just as Phase I is preparing to end, but experimentation and adjustment for optimization to the individual circuit conditions may be required.

Invoking the Lenz law reaction by minimizing the stimulus pulse cutoff time, Bedini sharply increases the already-increased negative resistor overpotential by a Lenz's law induced voltage surge, and sharply raises it to as much as 400 volts nominally. The process also sustains the negative resistor overpotential for a longer period, while increasing it again during this second phase. Thus even more free energy from the altered local vacuum potential is delivered to the ions in charging mode inside the battery, while simultaneously even more energy is delivered to the external circuit electrons in powering mode. The overpotential period is also extended. In this second phase, the extra energy  $W_{IONS}$  added to the ions in recharging mode is given by

$$W_{IONS} = f(400 - 12)(Q_{IONS}) \quad [4-5]$$

and the extra energy  $W_E$  added to the electrons in system powering mode is given by

$$W_E = f(400-12)(Q_E) \quad [4-6]$$

The total energy added to the system in Phase I by the negative resistor is

$$W_T = W_{IONS} + W_E = f(100-12)(Q_E + Q_{IONS}) \quad [4-7]$$

The total energy added to the system in Phase II by the negative resistor is

$$W_T = W_{IONS} + W_E = f(400-12)(Q_E + Q_{IONS}) \quad [4-8]$$

And so the total energy added to the system by the Bedini process is just the summation of equations [4-7] and [4-8]. With adroit switching, Bedini need only "pay" a small fraction of that freely received excess energy, in his own operator's input pulse energy and switching costs.

So by invoking a novel negative resistance effect directly upon the driving plate of the battery, Bedini creates (in the first phase) and then further enhances (in the second phase) a "nearly free" overpotential and overpotential period inside the battery. This excess potential directly upon the electron-pileup plate acts in both directions — out into the electrolyte between the plates to overpotentialize the ions in charging mode, and back out into the external circuit in powering mode to overpotentialize the electrons now powering the load. During a fraction of the operating cycle, Bedini recharges the battery while powering the circuit simultaneously, and thus has invented a novel method for extracting energy from the vacuum and curved spacetime to enable a COP>1.0 power system.

This is just a description of one fundamental period where Bedini applies his negative resistance process.



Several other places in the operation of the circuit lend themselves to additional phases of negative resistor formation and usage, and Bedini does use them. We do not discuss them here, since our purpose is only to advance the *fundamental principle involved*.

### 5.8.6 Independent Replication of the Bedini Negative Resistor Effect

Independent replication of the Bedini effect was accomplished early on by Nelson and by Cole, and also by Watson. Nelson has chosen not to further publicize his own work for some years, perhaps due to his employment as a microwave switching engineer in a large (and conservative) aerospace company. Cole is deceased, and Watson abruptly withdrew —forcibly, in our opinion — from public research and all further contact with his close colleagues after successfully demonstrating (in 1984) an 8-kilowatt power system utilizing a modification of the Bedini process. We are almost certain that Watson received the "offer he could not refuse", and that Watson-type COP $>1.0$  power systems are in fact already powering exotic underground facilities that "officially do not exist" but which we are aware of. We briefly discuss Watson's 8 kW generator at the end of this Chapter.

For non-battery powered systems, as we explain in Chapter 9, any unitary COP $\gg 1.0$  EM system may experience a Dirac sea hole current decay mechanism which will produce an effective extra "load" in the system's input section, including on out into the external power system. As a general rule (sometimes violated), we estimate that the effect begins to be of importance at COP  $> 10^3$  or so. Certainly it is of great importance in the range of COP  $> 10^5$ . To operate stably at COP  $\gg 1.0$ , this decay mechanism must be dealt with and prevented. For close-looping into self-powering mode, this negative energy feedback must be converted to positive energy feedback, thus allowing self-powering mode where all the input energy is freely received from the vacuum.

**For** battery powered systems, the hole current and "extra load in the input section" becomes of significance near COP = 2.0 or even less, because of interaction with the complex battery chemistry and the tendency to charge **the** battery with negative energy as well. So battery powered systems present a special problem for close-looping to achieve sustained self-operation. Bedini has long solved and demonstrated solutions to that problem in a variety of successful experimental systems.

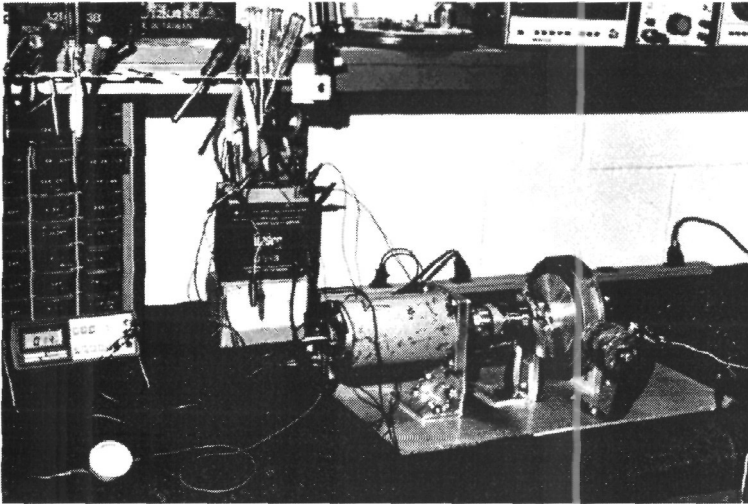

Figure 5-11 **Bedini motor** similar to the type which ran continuously off a battery for three years, simultaneously recharging the battery.

To utilize Bedini's battery-powered system at  $COP > 2.0$ , or to close-loop it for sustained operation, one must add another Bedini process that transforms negative energy current into positive energy current. That is Bedini's *transducing* negative resistor process {336}. We describe that process briefly in the next paragraph below.

Bedini has built many different motor-generator versions of systems self-powered by use of his negative resistor processes. Figure 5-11 shows a Bedini motor similar to one that once ran off a single battery for more than three years without stopping, using the forerunner of the Bedini back-popping process for creating a negative resistance in the battery. Bedini is still building and testing such power systems; one of his prototype motor-generators today, capable of operating and self-powering off a single battery, is shown in Figure 5-12.

### 5.8.7 Bedini's Transducing Negative Resistor.

Figure 5-13 gives a simplified block diagram of Bedini's transducing negative resistor process, which asymmetrically regauges negative EM energy into positive EM energy. With this process Bedini is able to intercept the Dirac sea hole current running from the output section of a  $COP > 1.0$  EM system to its input section, and divert the negative energy Dirac hole current to "reverse charge" a capacitor. The "reverse charge" consists of providing a hole current to the anti-negative plate of the

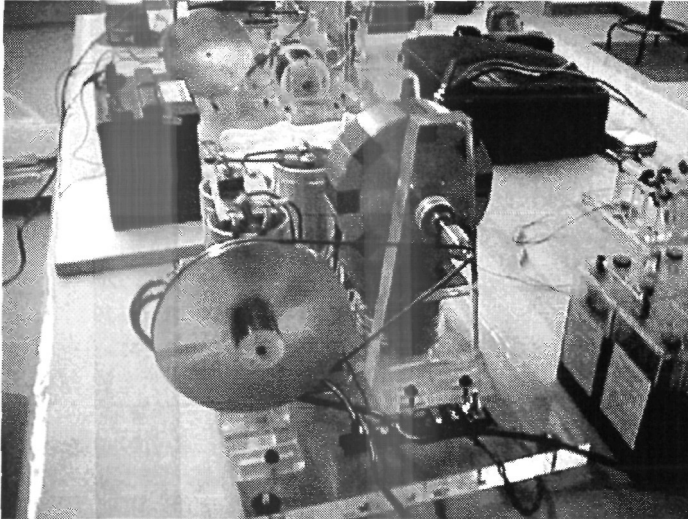
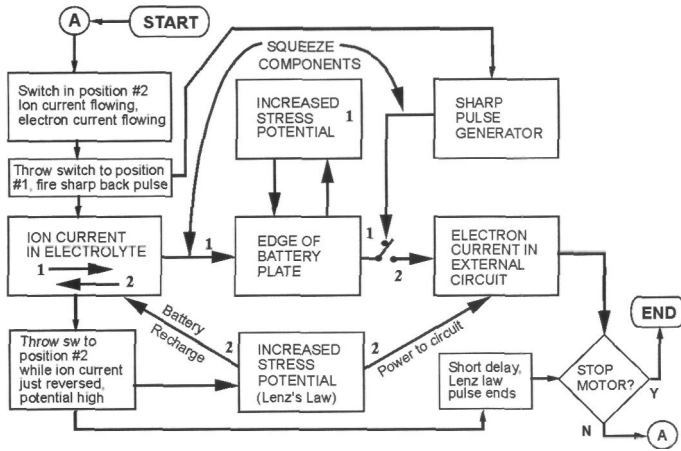

Figure 5-12 Modern Bedini motor prototype which operates off a single battery, powering the load and recharging the battery also.

capacitor, so that holes acting as positrons pile up in the local vacuum of **that** plate. This attracts the trapped electron charges in the dielectric, straining the dielectric in the direction of the hole collection. At the same time, the other plate draws electrons from the system that would otherwise be in currents that fight the back emf of the primary source dipole for the system. That reduces the back emf of the system during the charging of the capacitor; in effect, the back emf has participated in charging the capacitor with excess electrons on the negative plate.

**Then** Bedini reconnects the charged capacitor to the conductors leading to **the** power supply, discharging the capacitor by electrons furnished to the negative driving plate of the battery powering the system, and simultaneously to the input section of the system itself in normal powering mode. Note that the holes simultaneously discharge from the capacitor's anti-negative plate to the ground side of the battery, further charging the **battery** (the power source!) and the load as well.



**Figure 5-13** Bedini transducing negative resistor process block diagram. Adjusting timing of rear edge of pulse adds additional Lenz law increase.

Though it does not appear in the conventional textbooks,<sup>151</sup> one can power a load directly by Dirac hole current, but one does so by using the hole current in exactly reverse fashion from how one would use electron current to power the load. Semiconductor components are also critical and usually should be avoided. In short, one simply reverses the terminal that is considered the "driving terminal", and feeds the hole current to that "anti-negative" terminal as now the temporary driving terminal.

The Bedini process thus allows the Dirac hole current (negative energy) produced by a  $COP > 1.0$  EM system to be fed back to the input section and transduced into positive energy input to power the system with electron current and also to recharge the battery with positive energy.

<sup>151</sup> Lattice hole currents of course do appear and are considered. However, even though the circuit designers consider a lattice hole as a positron, it is not such at all, because the  $m/q$  ratio of the ion with one + charge is quite different from the  $m/q$  ratio of a true positron. The Dirac hole in the vacuum is effectively the "4-positron" — still in negative energy Dirac 4-electron state — before its observation or interaction with mass. It is a true negative energy entity, and thus a negative mass entity. Prior to observation, it actually should be said to be a "negative energy x time" entity and a negative "masstime" entity. It is also a negative energy electron entity. This subtlety is essential if one wishes to produce successful antigravity experiments on the bench, as we point to in this book and as were exhibited by the Sweet vacuum triode amplifier at  $COP > 1.5 \times 10^6$ .

This converts what would otherwise be negative energy feedback to the input section of the system (and to the battery) to positive energy feedback to its input section and to the battery. Instead of seeing the negative energy current in the input as an additional "load" to be powered, the external power supply sees it as excess positive energy input by the environment to the system, reducing the "load" represented by the system. It thus reduces the power required by the system from the external power supply.

When the amount of "transduced" positive feedback electron current to the input section equals the "normal electron current draw" required by the system, the battery (or generator) can be disconnected and the unit will continue to operate in the self-powering mode, fed completely by the positive energy from the Bedini transduction process. The other *supersystem components* (comprising the external environment of the system) will continue to power the system and its loads and losses, with all the input energy to the system being taken from the combined active local vacuum and local curvature of spacetime.

### 5.8.8 Gray's "Splitting the Positive Pole" Engine.

One of the real pioneers in early application of causal positron energy was inventor Edwin V. Gray of Van Nuys California. In WW II Gray learned radar during his tour in the U.S. Navy, having previously attended advanced engineering school in the Army until discovered to be under age 15 and discharged. After the war, by 1958 he had learned to perform what he called "splitting the positive pole", using "cold electrical energy" (his name for negative EM energy) as well as the normal positive electrical energy. His first motor was operating by 1961. Preparing to put units into production, in 1974 the Los Angeles District Attorney confiscated all Gray's records and prototypes. To escape bogus charges, Gray later pleaded guilty to two minor infractions and was released. His prototypes were never returned. After several mishaps, moves, and more prototypes, Gray died in Nevada under mysterious circumstances in April 1989. We quote directly from Lindemann {341}:

*"In the early 1980's, Gray offered the U.S. Government his technology to augment Reagan's SDI program. He actually wrote letters to every member of Congress, both Senators and Representatives, as well as the President, Vice-President, and every member of the Cabinet. Remarkably, ... Gray did not receive a single reply or even an acknowledgement!"*

In fact, during his early experiments, Gray discovered he could power light bulbs with cold energy, etc. Later he was to demonstrate this fact in a sensational manner: With a light bulb lit from his generator, he simply immersed the lamp — electrical leads and all — in water, where it remained lit. With his hands in the water, he would have been electrocuted or severely shocked if the electrical energy involved had *been positive* (diverging) energy. Instead, it was *negative* (converging) energy.<sup>152</sup> Another demonstration was to hit the coil of an electromagnet with some 3,000 volts, which hurled the electromagnetic into the air — but did not heat it. The electromagnet's coil would have been instantly melted if the energy had been positive, and the magnet would have been heated.

The reader should recall the timing of Dirac's theory of the electron {498a-b, 249}, which included the negative energy electron as early as 1930. Dirac also pointed out that we would observe this negative energy electron as a positive energy electron of opposite (positive) charge and positive mass, going in the opposite direction. The *observed* 3-positron and the *unobserved* negative energy 4-electron are quite different entities, producing quite different EM fields. The positron produces positive energy EM fields and positive gravity while the negative energy 4-electron produces negative energy EM fields and negative gravity.

In 1930, to his previous theory of the electron Dirac introduced the vacuum energy: the electron sea filled with electrons occupying negative

<sup>152</sup> By convention, "positive" energy has been associated with diverging EM energy, which is heating. Negative EM energy is associated with converging EM energy, which is cooling. In scalar interferometry {79}, one can control whether the distant EM field energy emerging in space in the distant interference zone shall be diverging (positive) EM field energy or converging (negative, cooling) EM field energy. This is determined simply by the biasing of the electrical grounds of the interferometer transmitters. The weather control referred to in 1997 by Secretary of Defense Cohen {89} is accomplished by using multiple scalar interferometers, some to gently heat the atmosphere in certain selected local areas (forming low pressure areas by expansion of the air) while cooling it in other selected local areas (forming high pressure areas by contraction of the air). By then moving these highs and lows around adroitly, one can capture and steer the giant jet streams, thereby steering the weather as one wishes, and directing significant weather changes into an area. By placing fairly sharp turns on the jet streams, one can induce great spin energy, thereby spawning tornadoes. Interestingly, by sharply pulsing the interferometer and controlling its electrical ground bias, distant cold explosions or hot explosions can be produced at will. Such weapons have been tested worldwide, and many test incidents are given in our older books *Fer-de-Lance* and *Gravitobiology*. Information on such incidents is available on website <http://www.cheniery.org> .

energy states. The holes are treated as the positive electrons (as if observed). This vacuum energy medium is now referred to as the "Dirac Sea." First, Dirac attempted to identify these holes with protons, but that was falsified. Later the positron was experimentally discovered.

One of the problems with present conventional application of Dirac's theory is that the positron is not used in its *unobservable causal negative energy 4-electron state* by modern theorists and experimentalists, but *after observation* where its direction has been reversed, its charge has been reversed, time has been stripped away, and the mass has become positive. So it is actually used as a positive energy entity having positive mass, and producing positive energy EM fields and positive gravity. This defeats the entire magic of the causal (unobserved) 4-positron as the electron carrier of negative mass and negative energy (*convergent* electromagnetic energy) in currents in the vacuum (spacetime) itself, rather than the electron carrier of positive mass and positive energy in ordinary 3-space. By replacing the unobserved (causal) vacuum 4-positron (negative energy electron) with the observed (effect) 3-positron with positive mass and positive energy, the entire vast area of negative energy EM fields — and thus direct antigravity via electromagnetic means — is discarded.<sup>153</sup> But the physicists avoided having to grapple with practical negative mass and practical negative energy (cool mass and cool energy). It also set back the pace of physics in discovering and engineering antigravity transportation for nearly three quarters of a century.

It appears that Gray's thinking about cold energy was more prosaic than the somewhat esoteric considerations of the Dirac Sea theory. Conventional electrical engineering circuit theory considers positive charges moving around a circuit (although some electronics technical circuits required thinking in terms of electron current). Hence the "high" side of the standard circuit was the positive polarity, or the positive pole of the terminals of a generator or battery. From this "positive pole", positive current was sent around the external circuit to the ground return line by the forward emf (forward voltage). However, forcibly returning to the positive pole from the ground return line (i.e., from the negative pole) were those

<sup>153</sup> When the huge nondiverged Heaviside energy flow component is appreciably of "convergent" or of negative EM energy rather than positive EM energy, the antigravitational aspects are substantive and observable (and practical). The unaccounted Heaviside negative energy flow component is often a trillion or more times as great as the accounted Poynting negative energy flow component. Hence **antigravity** technology is possible and practical, as we present in a later chapter.

same positive charges, being forced back up by the back emf and requiring expenditure of half the external circuit's collected Poynting energy.

So to Gray, the positive pole had two currents, one useful and one usually detrimental. The positive pole had (i) outgoing positive emf current powering the external circuit's loads and losses, doing the beneficial work (dissipating energy) in the external circuit with its load, and (ii) incoming positive current being forced back up against the back emf, doing the harmful work against the back emf and using up half the energy previously collected out there in the external circuit. Gray was aware that the work against the back emf was equal to the work done by the forward emf. So he set out to split these two currents apart, and catch the incoming current against the back emf separately, then use that normally wasted or oppositional energy to further power loads and/or recharge the batteries powering the system. Something like this was the way he was thinking.

That is what Gray called "splitting the positive pole". He also reasoned (and found) that the "reverse current" must be cooling instead of heating, since it moves against the voltage and acts backwards from regular current dissipated in resistors, etc. This precisely matches the cold (negative) energy phenomena met in the Sweet vacuum triode amplifier and in the motionless electromagnetic generator, as well as other  $COP > 1.0$  electrical systems.

Gray's later demonstrations showed that he had recognized this process or something very similar to it, in his "splitting the positive pole".

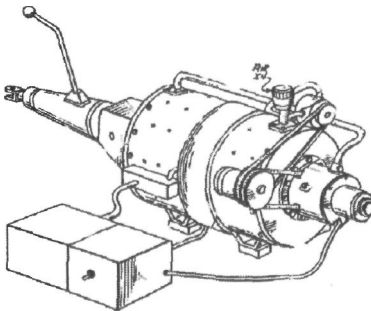

5-14 a The Gray engine

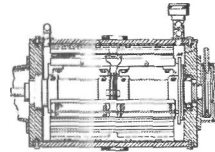

5-14 b Cross section view

US Patent No 3,890,548  
issued 17 June 1975

Figure 5-14 Gray's "splitting the positive"  $COP > 1.0$  engine.



To take advantage of his concept and principles, Gray developed a special engine shown in Figure 5-14. In 1975 Gray received a patent on this engine {337} along with his special means of battery powering and special switching circuits.

Gray's engine uses pulsed capacitive discharge to power a magnetic motor, with recharging of the powering capacitors taking place *between* successive discharge positions of rotor and stator. The motor runs by initiating repulsion rather than attraction, which — apparently without Gray recognizing it in such terms — invokes the notion of the "superpole" pioneered by Bedini. The superpole is an important concept in COP>1.0 research, though most researchers in the field have never heard of it. John Bedini conceived it several decades ago and demonstrated the surprising difference between a superpole and a common pole of double strength.

When two equal and like magnetic poles are facing each other in repulsion with a small gap between them, a net stress magnetic potential (pole) is formed in that gap which has an energy density some four times as strong as the normal field energy density in the field from one of the two opposing like poles. Hence the local energy density of the vacuum in the gap has been substantially increased above the energy density in the field region between a north and a south pole facing each other. Further, this energy density is in a "field-free" Lorentz-regauged form, i.e., a stress potential form. From that superpotential *outward*, there exists a normal magnetic field. But in it, there is no net magnetic field, but there is a "stress" field nonetheless.

Compared to an ordinary magnetic motor using attraction as well as some repulsion, the exclusive use by Gray of the Bedini "superpole" principle caused an extra *symmetrical* regauging<sup>154</sup> of the local vacuum energy input to the system (to the gap between the poles) as the magnetic superpole

<sup>154</sup> Every conventional electrodynamics text already assumes and uses the Lorentz-Lorentz symmetrical regauging as being absolutely free. Symmetrical regauging assumes that the energy of the system has been freely changed twice, but in such a way that the two free fields formed are equal and opposite, forming a stress potential. Gray found how to split apart and separately use these two "free-flowing exchanges of energy between system and active vacuum" that comprise the overall stress potential of the system, and thereby violated the Lorentz-Lorentz symmetry condition, freeing the two equal and opposite EM fields and their free energy to be used individually and beneficially to (i) provide extra power to the load and (ii) recharge the powering batteries so they did not run down. Using a different method. **Bedini** has done likewise.

(stress magnetic scalar potential). However, this stress potential is comprised of bidirectional longitudinal wavepairs, as shown by Whittaker in 1903. This superpole or stress potential thus can and does "split" into two different fields in antiparallel directions from each other. Since the north pole is deemed "positive" in magnetics, then using the two anti-fields comprising the free positive superpole is indeed "splitting the positive pole". Gray coined a very apt phrase for what he was doing.

Each of those antiparallel fields also involves an associated and unaccounted phase conjugate field {338a-c}, hence it is a time-reversed field (after observation). So opposing time-polarized EM waves also accompany Whittaker's decomposition waves. In short, the scalar potential accomplishes *optical-type pumping* in the time domain, and can be used to demonstrate time-reversal (as in Becker's bone-healing method).

Before observation (interaction with charged mass) and while still in the causal state, *the EM field from the positive pole is actually an EM field from a negative energy 4-electron, and the field can be taken to be a negative energy field!* In our view, positive energy enters every point dipole in the polarized vacuum at the negative charge, thence to the positive charge, thence back to the time domain. From the positive charge, the positive energy is leaving 3-space back to the time domain. Hence positive EM energy diverges from the negative charge and converges on the positive charge, then "disappears", so to speak, back to the time domain from whence it came. The "disappearance" of positive (divergent) energy is the disappearance of heat energy; hence it is a cooling process rather than a heating process. Or said another way, *negative* EM energy enters 3-space at each point dipole, entering from the time domain to the positive charge. Thence it moves to the negative charge, and back to the time domain. We see or detect the positive energy flow in 3-space directly, while the negative energy flow in the Dirac vacuum is evidenced by the "backwards" interaction creating Newton's third law reaction force.

By splitting the positive superpole, one has effectively destroyed the Lorentz symmetry condition. Hence the excess energy in the superpole will be capable of performing real work in the system in two directions. One direction is from the system to the external environment so that it produces the dissipation of energy (therefore work) in the loads and losses. The other direction produces a "negative resistor" or negentropic action that adds that much excess usable energy to the system back into its input section. By adroitly intercepting and switching that energy into capacitors and/or batteries, Gray was able to charge capacitors, recharge batteries,

and even power loads with cool energy (as demonstrated later by immersing a lighted electrical line and a lit light bulb in water).

A positive-energy resistor becomes a negative resistor when fed with negative energy. Then it converges positive EM energy from the external environment and outputs it into the circuit in which the resistor is connected. Note that this is the same statement as the resistor receiving (extracting) negative energy from the circuit and emitting it back to the time-domain. *That's like extracting back emf from the circuit and tossing it off to the time domain.* A conductor to positive energy flow is an insulator or dielectric to negative energy flow. Hence the normally "conductive" water was a neat insulator for Gray's "dunking" demonstration of negative power, as were his own normally conductive hand and body. To negative energy, a coil seems to produce capacitance rather than inductance, while a capacitor seems to produce inductance rather than capacitance.

Thus when the "positive pole is **split**" in the system, the system has broken **its** Lorentz regauging and is an open system in disequilibrium with the external vacuum environment, freely receiving excess energy from it.<sup>155</sup> With adroit switching and energy capture, such a system is permitted to exhibit COP>1.0 because it has violated the free Lorentz regauging once the excess energy in the superpole region is discharged and used.

<sup>155</sup> When one analyzes the supersystem of any Lorentz-regauged EM system, one realizes that the extra stress potential energy — entering the system and "locked up" as a stress potential due to the Lorentz condition — is actually a special relativistic **rotation** of the frame of the power unit away from the laboratory frame. That is, the system when rotated away from the lab frame, takes on free symmetrical regauging energy in that rotated frame as an excess stress potential. Gray's "splitting the positive" process simply separated the two apposite fields comprising the stress potential, then produced excess free energy from that *broken* free regauging Lorentz condition. Literally Gray splits Lorentz's stress potential into halves, the halves being its two opposing EM fields and their energy. This is equivalent to the system being rotated back into the lab frame, releasing its excess energy it possessed in the rotated frame back into the lab frame. Richard "Scott" McKie has also filed a patent on an invention deliberately rotating a capacitor's frame and fully charging it — while it is in its rotated frame. The rotated capacitor can be charged with less energy furnished from the lab frame, than is obtained back out of the capacitor in the lab frame when the charged capacitor is suddenly rotated back and discharged. At least in **theory**, McKie's overunity process should be workable if the switching costs are negligible. Our contribution to McKie was to advance the theoretical mechanism for **the** experimental mechanism he had discovered and was using.

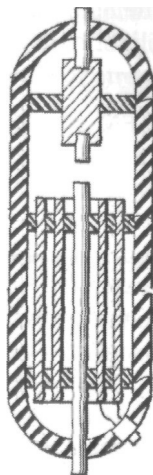

From US Patent No 4 661747  
issued 28 April 1987

Also in U S Patent No 4595,975  
issued June 17, 1986

Figure 5-15 Gray's conversion tube used with power systems,

Gray also utilized a special conversion discharge tube, shown in Figure 5-15. This tube uses the fact that a very sharp pulsed discharge in it results in a temporary  $COP \gg 1.0$  condition. This  $COP \gg 1.0$  condition instantly involves causal Dirac sea 4-positrons, moving as negative mass current and negative energy current in the local vacuum, which sweep back from the output side of the discharge to the input side.

We also point out the severe overpotential that must accompany any such violent pulse discharge process. The overpotential is a departure from equilibrium conditions, and is the difference between the actual potential and the equilibrium potential. The overpotential is well known and utilized extensively in electrochemistry {339a-c}, but is little used in conventional circuit theory. Nonetheless, it is involved in cold fusion processes due to the double layer phenomena {340a-b}, and it is involved in all electrode discharges (as from a cathode to an anode). It is also involved widely in electrochemistry and ion processes in solution.

Figure 5-16 shows Gray's circuit containing his conversion tube. Figure 5-17 shows Bedini's successful replication of the Gray conversion tube. Figures 5-18, 5-19, 5-20, and 5-21 show four pertinent pages from Bedini's laboratory notebook on his replication of the Gray conversion tube and the Gray motor system.

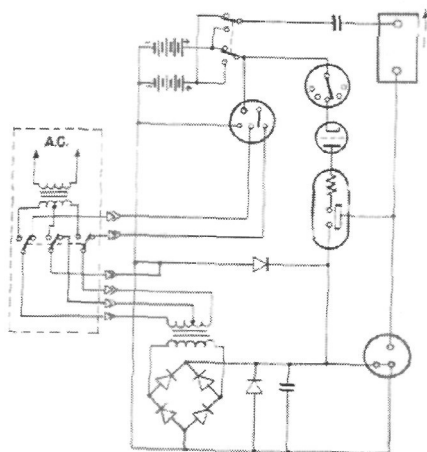

From U S Patent No 4 661 747  
issued 28 April 1987

Also in US Patent No 4 595 975  
issued June 17, 1986

Figure 5-16 Gray's circuit containing his conversion tube.

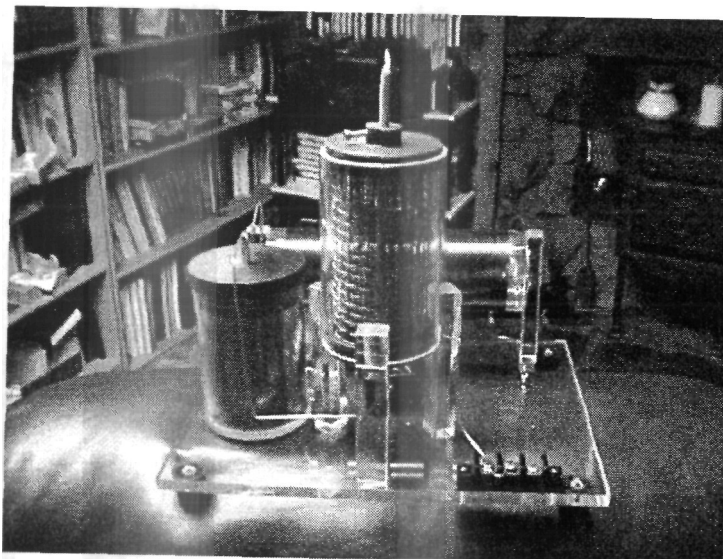

Figure 5-17 Bedini's successful replication of the Gray conversion tube.



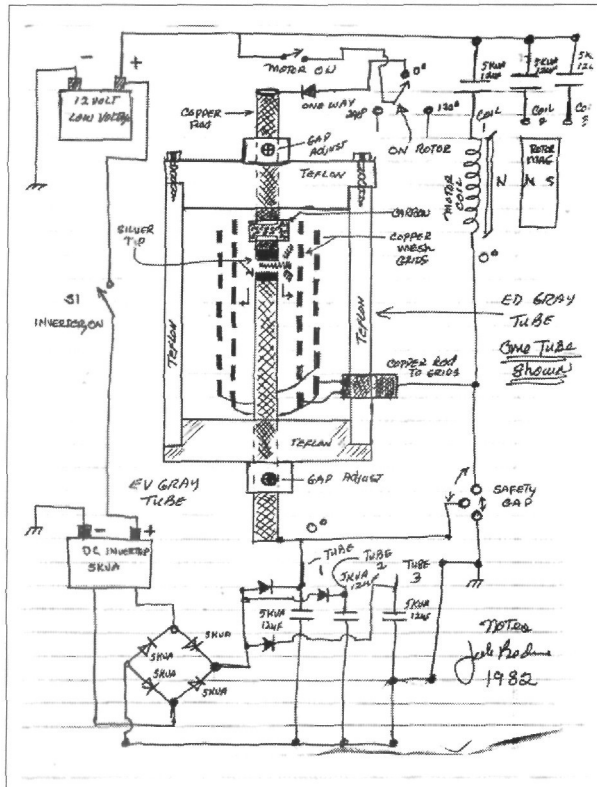

Figure 5-20 Page 3 from Bedini's lab notebook on the Gray conversion tube.

In science, when a novel experiment is replicated independently, that experiment then is established as a scientific fact. It then becomes the task of the theorists to either change the theory to accommodate the experimental results, or come up with a new theory to explain them. With Bedini's successful replication of Gray's work and extension of it, that work has now been scientifically established. With his "splitting the positive pole", Gray was referring to an actual, useful mechanism he evoked and used in the processes ongoing in his motor, in his conversion tube, and in his power system.

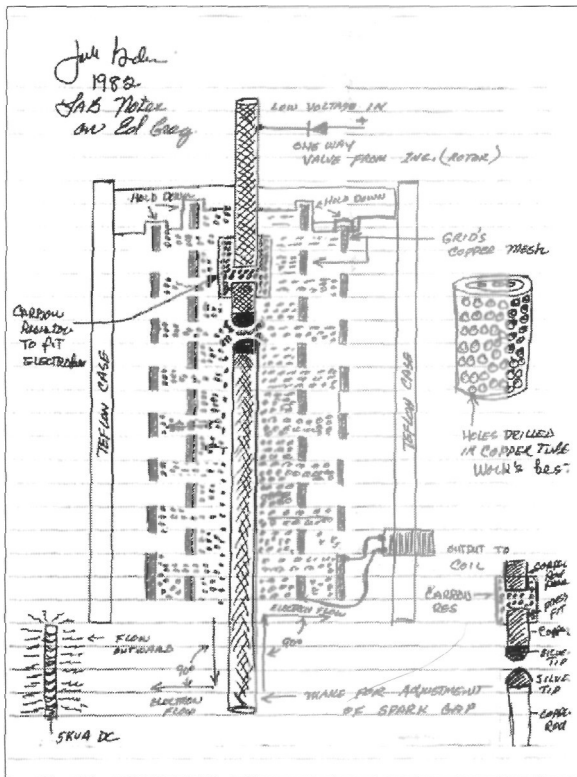

Figure 5-21 Page 4 from Bedini's lab notebook on the Gray conversion tube.

For further discussions about the Gray motor, conversion tube, and the history of it all, one is referred to the book by Lindemann {341}.

### 5.8.9 Watson's Self-Powering Generator

See Figure 5-22. In 1984, Jim Watson demonstrated a self-powering 8-kilowatt generator at the International Tesla Conference in Colorado Springs. This generator was a modified extension of smaller motors and generators built by Bedini over a period of years. At the conference, engineers from the audience were invited to the platform to perform their own independent measurements of the unit, while it was running and powering its load. The engineers directly confirmed that the system was delivering power to the load (as could be seen visually also), and that it was recharging its batteries as well.



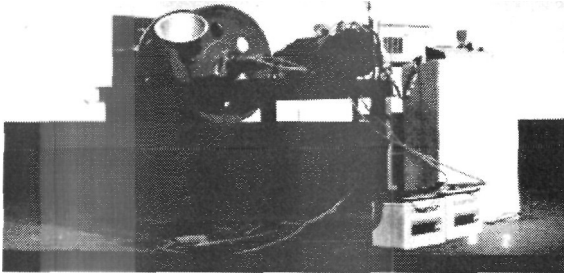

Figure 5-22 Watson's self-powered 8 kW generator demonstrated in 1984.

Interestingly, one of Watson's batteries was stolen that night. The reason was obvious. First, at the conference there was present one of the major persons charged with suppression of  $COP > 1.0$  electrical power systems world wide, along with several of his henchmen. Since they have been involved in suppressing many dozens of similar  $COP > 1.0$  systems, they are thoroughly familiar with both the theory of  $COP > 1.0$  electrical power systems and the various types of devices and mechanisms that have been invented in that area over the past century.

One feature of Watson's unit was that it charged the batteries with negative energy (i.e., with Dirac sea hole current, or "cold energy" as sometimes referred to), and could use negative energy for powering the unit. Hence, his batteries became charged with negative energy as the machine ran and powered its loads. After much demonstration and running, such a negatively charged battery has its local curved vacuum charged with an appreciable number of unfilled Dirac holes. Such a negatively charged "battery supersystem" will then absorb positive energy charging (electron current charging) for a protracted period before it will start to change its voltage and accept the positive charge. Instead, during that protracted initial period the battery will just "eat electron currents and positive energy" from the battery charger, with no apparent effect and no change in its discharged state or its voltage.

A very simple way to absolutely ascertain whether or not a unit such as Watson's (without a Bedini negative energy converter) is genuine, is to **simply** take one of his batteries from a unit that has been running quite a bit, and recharge it on a conventional battery charger. If it exhibits that two-phased recharge phenomenon, it proves that the unit is real and is

indeed a true COP>1.0 device, or certainly has the potential to be one. Coupled with the demonstration and independent measurements, this removed all doubts about the validity of Watson's COP>1.0 system.

So it appears that certain parties who were concerned about that system decided to do the "simple test" to see if Watson's device was real. It was real, and so they discovered. At that point, the High Cabal — Winston Churchill's term — recognized they had another successful unit and inventor to suppress.

Bedini and I were in close contact with Watson over a period of years, as often as three or more times a week. Later, some time after that conference, abruptly Jim ceased all communication with his former close colleagues. For two days a rather crazy recording **was** on his phone, stating the Watsons had moved. Then that disappeared. Watson never again contacted either Bedini or me, or his own financial backer (the late R. J. Reynolds III). Even Reynolds could not find Watson's whereabouts at that time.

We are quite certain that Watson received the "offer he could not refuse". Simply put, this is the old Mafia trick of visiting the target, offering him a deal, and he has no choice but to accept or die. When this is used to suppress COP>1.0 systems, and some medical systems, the offer is usually: *"Accept the money and you and your family will live very comfortably, but you will never openly work on this again or communicate it. You either accept our generous offer, or you and your family will be dead when we leave here."* Assuming that happened Watson had no choice but to accept the several million dollars offered him.

He is still alive, because Jeane Manning physically ran into him at a conference — and recognized him and spoke to him — whereupon he withdrew abruptly and left the conference very hastily.

## 5.9 Suppression of Free Energy Systems Has Been Common

This is only one of many cases we know of where such suppression of overunity systems and inventors has been accomplished. Others are not so benign. Marinov was killed with a longitudinal EM wave shooter in Europe, and his body was thrown off a building to make it appear a suicide. The police allowed the body to lie on the pavement for a protracted time (it was emitting longitudinal EM waves from the time-charging action of the strike). When finally moved, the pavement glowed

in that area that had been underneath the body. Only one weapon on earth will kill a person in that manner, and that is a longitudinal EM wave "shooter".

Another prominent researcher was killed with a Venus technique (look it up, it's a distortion of the wave front) modified beam that plunges the heart into violent fibrillations. He rushed from a restaurant exclaiming, "They're killing me!" and died of a resulting heart attack. The present author was hit with just such a weapon in a restaurant here in Huntsville. A friend and I actually saw the weapon and the person wielding it. Knowing what it was and recognizing the symptoms, my seated companion and I were able to bolt out of the nearby back door during that minute or so we could still physically function. I personally saw the device and the person doing the beaming, and I have a witness to the event.

The partner of a colleague in Australia was killed on an upper floor by such a shooter from the street below, right through the walls. The assassin was observed, and was seen putting the bazooka-sized shooter back in his car, then speeding away. There are many other true incidents we could also relate, including a person killed by an ice-dart dipped in curare (a very professional hit method, used by some of the sinister arms of various intelligence systems). So there is more than just scientific work involved in pursuing COP>1.0 EM power systems. There can also be a direct threat to one's life, essentially at any time.

Almost any serious overunity researcher, who succeeds, will have had confrontations with assassination attempts, suppression attempts, threats, deliberate legal entanglements, etc. The present author is no exception. It is sad that one of the prerequisites for serious scientific work in this area is **often** a legal gun permit (for both the inventor and his wife) and either legally carrying a hidden weapon or never being very far from a weapon when working at home. As an old soldier, of course, one just shrugs and accepts it, and gets on with the job to the best of one's ability, albeit remaining very watchful and always on guard.

## 5.10 In Conclusion

In this chapter we have introduced many of the approaches to COP>1.0 EM systems or processes, or the possibility for such in some novel mechanisms known in science. Recalling our previously presented solution to the source charge problem, we emphasize to the reader that all assumed 3 - space EM processes are actually 4-space processes prior to observation, continually observed in iteratively frozen 3-snapshots by iteratively

invoking the  $d/dt$  operator that produces observation. Hence from the source charge (and source dipole) solution we realize that all EM energy in 3-space comes from the time-domain and returns to the time domain. It iteratively appears along the "line of propagation" in 3-space at each successive position, but does not continuously propagate in 3-space. It does continuously propagate in 4-space. Since all the EM energy in any EM circuit comes from the time domain via the broken symmetry of the source charges and source dipoles, then we need to apply this greater vision to the COP>1.0 mechanisms and approaches so that we see the 4-space to 3-space to 4-space interplays.

The notion of the negative resistor is particularly significant and direct in that respect, and we have presented several versions of true negative resistors. For those wishing to experiment, we would suggest the easiest thing to start with is the point contact transistor. Or, simply go to Naudin's website {313} and download his instructions for making a Chung-type negative resistor, build it, and do experiments with it by varying the pressure on the fibers etc.

Again, we have not presented "parts kits" with instructions, but we have presented things that have worked or can reasonably be expected to work with some effort. We have also discussed the principles involved, to the best of our ability. In a few cases, we have directed the reader to information on websites where building instructions for selected negative resistors and other devices are posted.

As in any other scientific endeavor, we also urge the interested reader to read the literature and check the references cited, or as many as possible. Increasing one's understanding of the area is necessary to increase one's probability of success in the area.

We also wish the reader good results and success in his or her research and experimenting. The energy crisis is not going to go away, and the demand for oil will double in the lifetime of many of our middle-aged or younger readers. The cheap oil peaks shortly and declines in availability forever thereafter {342}; this alone will drive up the price of oil and seriously impact the economies of the nations of the world. To keep from destroying the world economy and the biosphere, it is absolutely essential that COP>1.0 electrical power systems — including self-powering systems taking their input energy from the seething local vacuum — be developed to produce the necessary electrical energy needs of the world, cheaply, cleanly, and easily.

If one or more of the readers should succeed in developing and producing such systems, then the entire purpose of this book will have been fulfilled.

# Chapter 6

## Additional Approaches to Overunity Power Systems

*"Can the quantum potential carry a signal? If it can, we will be led to a violation of the principles of Einstein's theory of relativity, because the instantaneous interaction implied by the quantum potential will lead to the possibility of a signal that is faster than light... a signal has in general to be a complex structure, consisting of many events that are ordered in definite ways. In terms of our language, each signal is a supersystem of events, while each event is in turn a system of subevents.... At present, the answer is, of course, not known. " [Bohm and Hiley] {343}. A comment:<sup>156</sup>*

<sup>156</sup> We comment that the "event" involves observation: i.e., it is conceived as an *observed* event. In that exact sense, no signal in space carries "events" because there is no interaction with mass and no  $d/dt$  operation induced on entities (curvatures) of spacetime. The effect (observed) 3-space field cannot propagate faster than light, because it cannot even propagate in the first place! The totality of light's EM interactions with matter is what makes the observed field or observed signal to appear to be propagated at light speed. It is not actually "propagating", but being iteratively recreated from point to point in space *if observed at every point*. Signal in spacetime is causal and hence nonobservable; the interaction of causal signal with charged mass is observable and makes an "event". When we clearly differentiate the nonobserved (causal) 4-field or dynamic from the iteratively observed 3-field or dynamic, then the *nonobserved 4-field* or dynamic is not limited to light speed. Propagation along the time axis, e.g., can be at "infinite velocity" because a single **point** in time is connected to every point in the universe simultaneously. Since all EM energy in space comes from the time domain locally at each point dipole in 3 - space and returns to the time domain from that same point dipole, it is the notion of "propagation continuously through 3-space" at *any* velocity that is a non sequitur. Absolutely nothing propagates through 3-space! If general relativity is re-interpreted **to account** the difference between observed and unobserved (effect and cause), then the unobserved cause can propagate superluminally without violation of the "observed event (effect) propagation at light speed" of general relativity. It is the notion that anything propagates in 3-space that is the non sequitur, and it should be removed from special and general relativity as well as electrodynamics.

"...contrary to the conclusions of classical mechanics, there exist effects of potentials on charged particles, even in the region where all the fields (and therefore the forces on the particles) vanish. " [Aharonov and Bohm] {344}.

"...for any force varying as the inverse square of the distance, the potential of such force satisfies both Laplace's equation and also the wave equation, and can be analyzed into simple plane waves propagating with constant velocity. The sum of the waves, however, does not vary with time, i.e., they are standing waves. Therefore the force potential can be defined in terms of both standing waves, i.e., by a global, or non-local solution, and by propagating waves, i.e., by a local solution changing in time... Thus, Whittaker's mathematical statement related the inverse square law of force to the force potential defined in terms of both standing wave (i.e., global) and propagating wave (i.e., local) solutions. The analysis also showed that the electromagnetic force fields could be defined in terms of the derivatives of two scalar potentials. " [Barrett] {345}.

"What might appear to be empty space is, therefore, **a seething ferment of virtual particles**. A vacuum is not inert and featureless, but alive with throbbing **energy** and vitality. A 'real' particle such as an electron must always be viewed against this background of frenetic activity. When an electron moves through space, it is actually swimming in a sea of ghost particles of all varieties — virtual leptons, quarks, and messengers, entangled in a complex melee. The presence of the electron will distort this irreducible vacuum activity, and the distortion in turn reacts back on the electron. Even at rest, an electron is not at rest: it is being continually assaulted by all manner of other particles from the vacuum. " [Davies] {346}.

## 6.1 Introduction

In this chapter, we continue to present a selection of potential overunity systems, inventions, approaches, and selected mechanisms. We also make the reader aware **that quantum** mechanics, an entire branch of physics,

requires nonlocality and "instant propagation" in space. We utilize the quantum potential from Bohm's hidden variable theory of quantum mechanics {347} to impress the nonlocality. Further, the staid old scalar potential — which we meet as voltage in a circuit — also exhibits nonlocality and instant propagation in the Coulomb gauge {348}. Our purpose is to show that electrodynamics is not limited to the cut-and-dried subject as usually taught to electrical engineers and applied by them, but also covers a wide range of phenomenology that electrical engineers usually do not consider or account.

## 6.2 Energy Conversion and Energy Amplification

### 6.2.1 The Mead-Nachamkin Zero Point Energy Converter

It is well known that the vacuum interacts with electrical charges and dipoles, and also with the electrons in an atom. For example, Lamb received the 1955 Nobel Prize in physics jointly with Polykarp Kusch for experiments measuring the small displacement later called the "Lamb shift" of  $0.045$  eV of the energy levels in atomic hydrogen {349}.

Casimir {350a} proved that closely separated conducting plates also alter the energy density of the vacuum, thereby becoming an "energy extracting" method, although the energy is miniscule. It is quite real, however, as shown in meticulous experimental work by Lamoreaux {351}. **The** principle that vacuum energy interacts with matter, plates, and electrical double layers and circuits is well proven experimentally.

In 1996 Mead and Nachamkin were granted a patent on an overunity EM power system process for extracting zero-point energy of the vacuum {352}. If one closely examines the patent wording, the device is properly patented as an energy converter and does not overtly state that it is a  $COP > 1.0$  system. It is a  $COP > 1.0$  system, however, since the input energy is freely received from the vacuum and not input by the operator himself. **One** embodiment of the invention inserts a tiny coil between the plates to **extract** the energy. See Figure 6-1. The energy is based on the Casimir **effect** {26}, which was accurately measured in 1997 by Lamoreaux {27} **and** since then by others.<sup>157</sup> Further investigation of the force's behavior **with** the shape of the conducting plates has been performed by Chen *et*

<sup>157</sup> See also U. Mohideen and A. Roy, "Precision measurement of the Casimir force from 0.1 to 0.9 microns," *Phys. Rev. Lett.*, Vol. 81, January 1998, p. 4549.



al.<sup>158</sup> Numerous other papers of interest on the Casimir effect have also been published {353a-d}.

Because energy cannot be created or destroyed, any COP>1.0 system is an *energy converter*, a priori. It must receive the excess energy from the environment (in this case, from the curvature of spacetime and from the local active vacuum) and convert that energy to a form usable to power or assist in powering the system loads and losses.

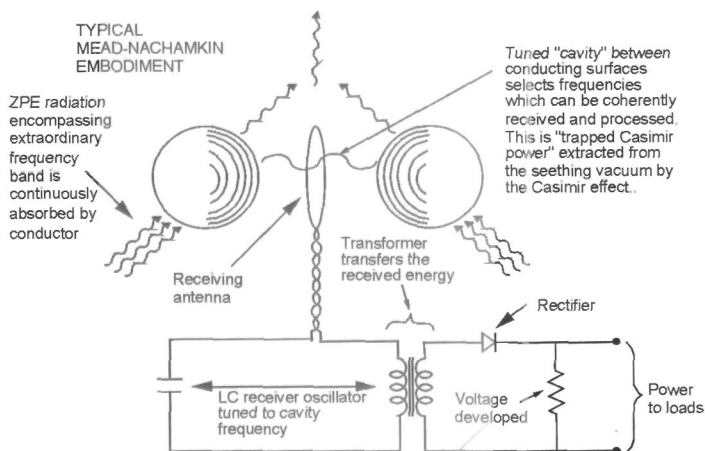

Figure 6-1 Mead-Nachamkin conducting surfaces, antenna, and receiver for extracting EM energy from the vacuum,

The Mead-Nachamkin patent is interesting because the physics of the device is proven and accepted. Getting sufficient power output to be useful for electrical power purposes, however, remains to be demonstrated, since the Casimir effect is very tiny.

### 6.2.2 The Quantum Potential As an Energy Amplifier

In Bohm's hidden variable theory of quantum mechanics {354}, an extra potential is added to the Schrodinger equation, and is known as a *quantum potential*. Figure 6-2 lists the novel characteristics of this potential, and

<sup>158</sup> F. Chen, U. Mohideen, (G. L. Klimchitskaya, and V. M. Mostepanenko, "Demonstration of the Lateral Casimir h'orce," *Phys. Rev. Lett*, (in press as of the time of this writing).

### Quantum Potential Characteristics

- No point source; not radiated
- Just appears instantly
- Quantum potential between two particles
  - Interaction does not vanish as spatial separation becomes very large
  - Instantaneous connection
- Depends on quantum state of system as a whole
- System parts can be greatly separated

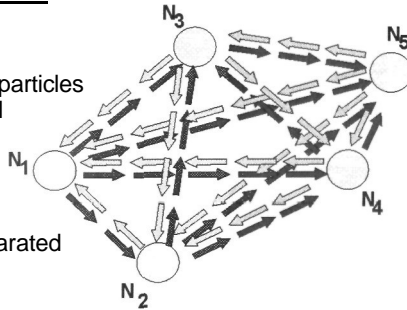

Figure 6-2 Quantum potential characteristics (table).

Figure 6-3 lists technical features of Bohm's hidden variable theory from whence the quantum potential is taken {355}. It can "move instantaneously", at "infinite velocity", which means it just suddenly appears everywhere it will be, and does not "propagate at a finite speed" through singly connected space at all {356}.

$$V_{\text{quantum}} = \frac{\hbar}{2m} \frac{\nabla^2 \sqrt{\rho}}{\sqrt{\rho}}$$

A quantum particle moves as if it were subject, in addition to its external potentials, to a potential which is a function of its own probability distribution.

Bohm's hidden variable theory assumes:

- Particle and wave function real and separate
- Wave function obeys Shrodinger's equation
- Particle obeys classical mechanics
- Particle couples to wave function through a quantum potential

Figure 6-3 Technical features of Bohm's hidden variable theory.

The potential is after all *potential energy*. With the quantum potential (QP), a joule of energy placed upon one collector, where that collector is connected via a QP with one or more distant collectors, will also result in a joule of energy (or some fraction thereof) instantly emerging upon and in each of those distant participating (QP-connected) stations simultaneously. It appears that, if only a fractional participation — say, 0.50 — exists with one or more of the distant stations, each of those stations will experience **the** appearance of that fraction (in this case, 0.5 joule) of the energy input to **the** initiating station. Any station can input energy, and it will

appropriately appear at every other participating station, regardless of where these stations are located in ordinary 3-space as seen by the external observer.

One way of expressing this "instantaneous QP connection" between separated objects is to model the different objects (or stations) as linked together in a multiply connected space, with a certain QP connection or collection fraction. Presence of energy at one station in the multiply connected group, results in the simultaneous appearance of the energy — or an appropriate fraction of it — at every other station in the group.

To understand multiply connected space, consider a single point on a plane. Now consider 999 more points superposed on/in that same point. But suppose that those thousand points are really located at different locations in 3-space, though superposed in this "crazy space" containing a plane where all of them are superposed at one point.

As the ordinary external observer, suppose you input a joule of energy into one of these — to you — separated points, which happens to be the original point and is located in your laboratory. Supposed the fractional connection is 1.0 (the connection is perfect in multiply connected space). Voila! Instantaneously one joule of energy appears at each and every one of those (to you) widely separated points. If you vary your input energy (e.g., as in communication), it varies precisely the same in each of those distant QP-connected points.

Those who continue to advocate that superluminal communication of information is impossible are ignoring present experimental proof that it does occur. As a single example (there are others), it has been shown by Enders and Nimtz {357} that Mozart's 40th symphony can be transmitted as frequency modulated microwaves through a barrier wave guide between two points in a waveguide, via quantum tunneling, at 4.7 times the speed of light  $c$ . We point out that this is achieved using *transverse* EM waves.

If *longitudinal* EM waves are used together with longitudinal modulation (which engineers might think of as a sort of "pulse compression" technique), the only limitation to the speed of communication is given by the impurity of the longitudinal EM wave one is able to make. The Fogal semiconductor, e.g., can be used to transduce ordinary transverse EM wave signals into longitudinal EM wave modulations inside a scalar potential. Hence that scalar potential can move in the Coulomb gauge at infinite velocity. It requires another Fogal semiconductor circuit on the receiving end to receive and transduce the longitudinal EM waves and their longitudinal modulations back into transverse EM waves for processing

and amplification by normal means. This capability of the Fogal semiconductor circuits has been demonstrated through satellite uplinks and downlinks coupled with long transmission line links, with essentially no delay from transmission to reception. One may think of the Fogal superluminal process as *tunneling through subspace*.

The best way to vary the energy is apparently by use of a variable stress potential (which translates to a longitudinal variation or modulation). In short, one must modulate the "internal energy" of the vacuum, so to speak, and not the "external energy". A reasonable discussion of internal energy versus external energy is given by Chen {358}. If one longitudinally modulates the internal energy of the vacuum potential — which, being a scalar potential, decomposes by the Whittaker decomposition {359} — then superluminal communication is not only possible but also practical. We expect Fogal to eventually place just such a system on the market, shortly after his semiconductors get into precision production.

One possible method of producing modulated internal stress potentials is by use of a Davis noninductive resistor {360}. Another is by use of a biwound coil with two windings, so that the two currents through two equal "superposed" coils are equal and opposite. We point out that, while there has been published much stuff and nonsense about such biwound coils, the truth is quite mundane. Simply examine the Lorentz symmetrical regauging applied to the Maxwell-Heaviside equations. It is the deliberate production of two equal and opposite force fields, which is in fact the creation of a stress potential and extra stress energy. By varying the magnitude of the Lorentz forces comprising the stress potential, the stress potential is varied in amplitude. Hence the concomitant longitudinal EM waves are varied in amplitude. A biwound coil is a variable Lorentz-regauging coil, *a priori*.

By oscillating the magnitude of any Lorentz regauging (which in the simplest case is simultaneously changing both opposing fields equally and oppositely), one can make longitudinal EM waves. By appropriately modulating both Lorentz regauging components, one can make longitudinal EM modulations upon those concomitant longitudinal EM wave carriers.

So with some careful tuning and adjustment, and a little nonlinear material in the core,<sup>159</sup> one should be able to have the superposed appositive

<sup>159</sup> The opposing waves must modulate (multiply), not mix (add), and modulation is a nonlinear process. Linear mixing of opposite waves or fields will not cause the

magnetic fields lock together (*modulate*, rather than linearly *add*) and produce a magnetostatic scalar potential stress signal in and from a nonlinear core material. We caution, however, that the biological effects of the radiation of such stress potentials internal to spacetime have not been investigated. The experimenter is cautioned that he experiments at his own risk, and he is cautioned to experiment only at low power levels until the phenomenology in a particular case is understood.

If we compare the stress potential oscillation (wave) to a sound wave, the similarities suggest that the stress potential oscillation can be treated as a longitudinal EM wave, if the two superposed opposing EM waves "lock together". Simple addition is insufficient; modulation is necessary. Hence the nonlinearity of the conductors and core material is of significance.

For instantaneously propagating potentials and pure longitudinal EM waves, any conceived difference between the two becomes somewhat academic. The characteristic of interest is the instant appearance of the input energy at multiple points via a multiply connected space.

To the ordinary observer, use of a quantum potential and multiply connected space measurably yields a fantastic *energy amplifier*. One furnishes one joule, and gets out — say — 1,000 joules in those distant locations altogether. As shown in Figure 6-4, the QP system is a communication system of enormous implications, particularly as humans travel into space across the solar system and even beyond. Unfortunately, by using appreciable power in the initiating station, the QP system also leads to weapon systems of incredible destructive capabilities. Some five nations {361} now possess such quantum potential weapons, which are the dominant weapons on Earth. We do not further discuss the quantum potential weapons aspects in this book.

Back to our little energy exercise, inputting one joule and getting out some 1,000 joules. Suppose these 1,000 participating points are not distant at all, but are gathered closely together into a local material but still QP-connected with a connection fraction of 1.0. Now we input a joule of energy to that device, and it develops and outputs one kilojoule. It is hypothesized that this becomes the ultimate negative resistor. It will also exhibit separated Dirac hole current phenomena as the COP increases and, if sufficient COP is developed, it will exhibit antigravity effects such as

fields to "lock together" into a common stress potential. Nonlinear mixing (modulation) will. Hence the nonlinear core is required for conversion of apposite fields to stress potentials and **Lorentz** regauging.

those shown by the Sweet vacuum triode amplifier discussed in this chapter.

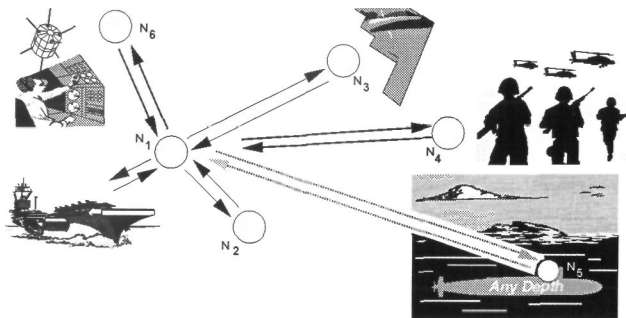

- Quantum potential decomposes per Whittaker 1903 into bidirectional longitudinal EM waves
- Can insert additional longitudinal waves, thus information using a Fogal semiconductor
- Can receive "signal" and discriminate the information using a Fogal semiconductor

Figure 6-4 Quantum potential communication system.

Strangely, overall conservation of energy is not violated by the quantum potential COP>1.0 energy system. It's just that the energy now is furnished from space (from the vacuum) in a *multiply connected* manner. However, all the excess energy is still furnished by the active external environment - i.e., from the time domain, according to the giant negentropy process {12} — though that environment now is quite novel and multiply connected. So we still have a system analogous to a windmill, though *a very novel windmill and a very novel wind indeed*.

Without belaboring the point, action-at-a-distance is absolutely required in quantum mechanics. Further, photon correlation experiments have long demonstrated experimentally that such action-at-a-distance effects do exist, just as predicted. This was a refutation to Einstein's objection to quantum mechanics' "spooky action at a distance".

We point out without further comment that, if a self-powered process is Invoked in the initiating station, then all other participating stations also contain that self-powered process. However, note that one does not really wish to "invoke" a quantum potential connection and use it except occasionally and very quickly! Otherwise, if a strong QP is turned on and **left** on among many distant stations, anything and everything happening to

each one of them can instantly appear in all of them, so long as the "constant of connectivity" remains a constant or nearly so.<sup>160</sup> For that reason, strong quantum potential connections can be self-destroying and strong effects do not seem to normally appear in the physical world.<sup>161</sup> The proper energy use of a quantum potential is thus to use it only for fleeting "inductions" of effects in the desired stations, in *momentarily* multiply connected spacetime, at least until the self-limiting behavior is ascertained.

Apparently, a quantum potential can sometimes be formed in the limit of an iterative, mutually phase conjugating operation of EM signals passed back and forth between two phase conjugate mirrors, or among many of them. Such iterative mutual phase conjugate reflection of signals — particularly pumped signals — is technically known as iterative *self-targeting*. Sometimes we use a more picturesque term, *ping-pong*, for iterative self-targeting.

Conceivably, strongly coupled, strongly pumped optical self-targeting mirrors can — in the extreme limit — initiate or partially initiate a quantum potential. The superposing beams of energy may be thought of as first narrowing to laser-like beams, then gradually subsiding into pure longitudinal waves with transverse components "canceled" to form simply "stress energy". In short, if this reaction occurs, the energy is transformed into a stress energy potential, which acts either as a scalar potential in the Coulomb gauge or as Bohm's quantum potential. In our view, the pure longitudinal wave has infinite velocity, as pointed out by Rodrigues and Lu {93a}, so Lorentz-Fitzgerald contraction results in "zero-separation distance", which in turn results in a multiply-connected spacetime.

One points out that the "input energy" to the initiating station may be deliberately structured internally, including altering the internal Whittaker longitudinal EM wave functions comprising the input electrical field

<sup>160</sup> Fortunately, it appears that this connectivity constant is not really constant, but reduces as the feedback of each station's fluctuations to the other stations increases. The result seems to be a "leveling off process reaching a plateau and a fixed amount of gain in the overall system. In short, the system usually seems to be "self-adjusting" and "self-limiting" as the overall gain increases. Nature is riddled with quantum potentials, but this self-limiting process keeps most so tiny that they are not even noticeable.

<sup>161</sup> However, the validity or invalidity of this statement for some of the highly energetic phenomena of astronomy remains to be determined. It also remains to be determined as far as the quantum potential's role in generating the zero point energy fluctuations of the active vacuum.

energy. In this manner, in theory deliberate spacetime curvature sets and dynamics can be introduced into the distant but multiply connected targets. A form of highly advanced electro-biological warfare induction of disease has been developed by at least one nation (Russia) in this regard, as an extension of Kaznacheyev's experiments showing induction of cellular disease at a distance. It appears that the cells of a living body are interconnected by a very weak quantum potential in such manner. Again, a great deal more research on that possibility is needed.

Given a quantum potential connection between separated objects including our initiating station, one can also add vacuum *engines* (energy structuring of curvatures of spacetime itself) as our input to the initiating node. Those vacuum engines will then simultaneously appear unabated (or only partially abated) in the multiply connected separated objects. In this way, in theory one can use the QP and QP energy to perform highly anomalous *momentary* engineering of nuclides, materials, fields, etc. in widely separated, distant objects and areas. By repeating the momentary engineering "pulses", distant objects and areas can be profoundly altered.

The use of vacuum engines in medical applications is of particular future interest.<sup>162</sup> Very radical extension of those techniques can be achieved once quantum potential technology is developed and available in the open scientific community.

But let us ignore the weapons, free our scientific imagination, and let it roam. As an example, in the future a vacuum engine (spacetime curvature engine) might be developed and utilized in a world-wide quantum potential to *momentarily* strike and eradicate all AIDS viruses on Earth, and do only that. Or, the engine could be slanted to simply *momentarily* slightly change

<sup>162</sup>See Vlail Kaznacheyev and L. P. Mikhailova, *Ultraweak Radiation in Intercellular Interactions*, [in Russian], Novosibirsk, 1981; Vlail Kaznacheyev *et al.*, "Distant intercellular interactions in a system of two tissue cultures," *Psychoenergetic Systems*, 1(3), Mar. 1976, p. 141-142; Vlail Kaznacheyev, "Apparent information transfer between two groups of cells," *Psychoenergetic Systems*, 1(1), Dec. 1974, p. 37. Unfortunately this QP induction of cellular disease has already been used by the former Soviet Union to develop a QP extension of the **force-free** structured potentials method first used to induce cellular disease and **health** changes in U.S. personnel in the former U.S. Embassy in Moscow for several decades. Now QP weapons using such techniques can target the entire population of a targeted nation. Using the internal Whittaker structuring of quantum potentials and EM fields and waves, *electromagnetic biological warfare* has already been born and highly developed. The actual dimensions of possible biological warfare strikes are far greater than has been mentioned in the open literature.



those viruses into an innocuous kind of new virus. The cells of the individual human body are already connected, it appears, by a very weak quantum potential. By connecting an external initiating station to that body's quantum potential, the energy of the body could be directly scanned, all abnormalities noted, and tailored engines created and *momentarily* used to treat the body and correct its abnormalities and malconditions. This, we believe, may well be a medical therapy of the future, a few generations from now. <sup>163</sup>

## 6.3 Other Systems of Electrical Interest

### 6.3.1 Russian Parametric Oscillator Power Systems

In leading physics institutes and laboratories in the 1930s, Russian scientists built COP>1.0 parametric oscillators, including some of appreciable size. The work is documented in the literature {362a-k}, both in Russia and in France. The devices were developed and tested in several Russian laboratories. With linear loads, the oscillators would progressively build to self-destruction. With nonlinear loads, the devices would stabilize and power themselves and their loads, at a level depending on conditions — reminiscent of the behavior shown in Figure 4-3 in Chapter 4 for stability COP>1.0 levels for the asymmetrical self-regauging process.

Standard references for parametric oscillation in EM circuits are available. However, with standard practices none of these conventional oscillators produces COP>1.0, primarily because the conventional closed current loop circuit is applied without special modifications. For overunity work, the

<sup>163</sup> Apparently, tests of such QP capabilities in weaponry have been gingerly conducted for direct induction of disease patterns in the population of a targeted nation or area. One symptom of such a test is that a very small number of widely isolated cases of the same disease breaks out simultaneously, in isolated cases scattered widely and puzzlingly throughout the population, *without the possibility of any direct carrier vector connection*. Apparently, the test inductions have deliberately been held mostly to the "shadow state" (or upper virtual state, just below observable state) in most of the targeted populace, to prevent giving away the tests. However, the human immune system and cellular regenerative system do respond to such "near-observable-state" signals and engines, when sustained or repeated in time, by a sort of coherent addition (integration) over time. The bell-shaped distribution curve predicts that a few individuals, randomly scattered throughout the populace, will have quite lower induction thresholds and will evidence the actual disease after a certain time, whereas in almost all the other members of that population the "disease" will never evidence in the observable state during that time. The test is deliberately terminated when only a few observable cases occur, which are sufficient to prove the efficacy of the test and the method.

Russian and French literature (as we referenced) should be meticulously studied and analyzed in a higher group symmetry electrodynamics, to see how the Lorentz condition is broken during discharge of circuit excitation energy in the load, and how the  $COP > 1.0$  Dirac hole current decay mechanism is avoided or contained.

The Russian  $COP > 1.0$  parametric oscillation work appears to have been suppressed by the Communist regime just prior to WW II. After the war, all such technology passed under the rigid control of the KGB (by whatever name it took and takes from time to time) and into the special weapons research and development area — still highly classified in Russia. We know of no similar work presently ongoing in the West, although at least an English translation of one of the major summary documents of the Russian parametric oscillation  $COP > 1.0$  power system developments was performed under NASA auspices {363}. However, in conventional U.S. parametric oscillation research, I know of no case where  $COP > 1.0$  operation is being sought, or where the Dirac sea hole current decay mechanism is even mentioned or recognized {364}.

### 6.3.2 Sweet Vacuum Triode Amplifier

During the 1980s and 1990s, the present author worked —sometimes closely for extended intervals — with inventor Floyd Sweet, the inventor of the Sweet vacuum triode amplifier (VTA). Indeed, we gave the unit its VTA name, at Sweet's request.

Fig. 6-5 (pg. 384) shows a diagrammatic illustration of the fundamental VTA construction. Two coils in quadrature are between two barium ferrite "brick" magnets, of the kind formerly used in many power audio systems. The vertical coil is the "input" signal coil, and the horizontal coil is the "output" power coil. The input consisted of a 33 microwatt 10 volt 60-Hertz signal, and the output was a 120-volt 60-Hertz 500-watt signal. The barium nuclei in the magnets were specially preconditioned by Sweet so that they were in powerful self-oscillation with the surrounding energetic vacuum. A double-edged razor blade or piece of shim stock placed on one of these magnets would oscillate back and forth, incessantly, without cessation — showing that the magnetic field itself was "waving" back and forth (Figure 6-6). It was also continually doing work against air **resistance**, by moving the air.

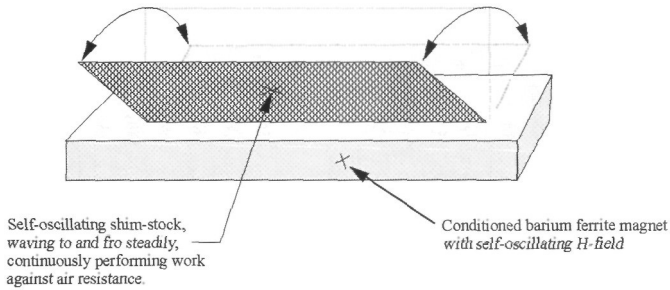

Figure 6-6 Blade waving continuously on Sweet's conditioned barium ferrite magnet.

Sweet had a Master's degree in electrical engineering from a leading university and handled the mathematical theory very well. He had worked at General Electric for many years, and Gabriel Kron was his patron and mentor. Sweet often spoke glowingly of Kron, and I came to believe that Sweet's VTA was probably an outgrowth of, or very similar to, Kron's negative resistor.

- Two activated magnets facing, with fields in self-oscillation.
- Barium ferrite magnets, barium nuclei in self-oscillation
- Barium nuclei self-pumped
- Two coils in quadrature, load is lamps, six watts
- Next unit produced 500 watts output with 330 microwatts input; later made 5 kW VTA

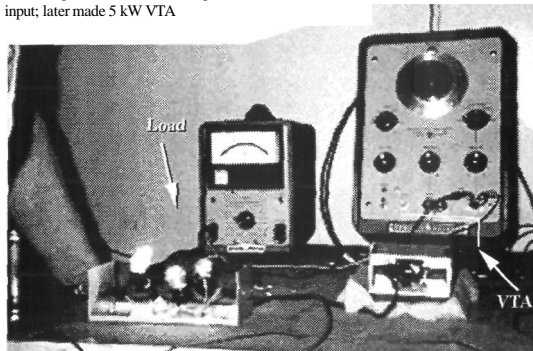

Figure 6-7 First Sweet VTA producing 6 watts output.

When I first met Sweet, his little VTA system was producing a 6-watt output, enough to light four 15 watts of auto lamps (Figure 6-7). But there

was no question as to the genuineness of the device. Nothing was hidden, and Sweet allowed me to measure the device at will, disassemble it, play with it, and examine it in any fashion. It was genuine, and not a hoax or trick. I also locked up one of his specially conditioned magnets for 24 hours, with a piece of shim stock sitting on the flat of the magnet and waving to and fro continuously, steadily performing work by moving air. When I opened the lock the next day, the shim stock was still there on the magnet and oscillating, having continuously done work against the air resistance for 24 hours with absolutely no energy input by the operator. And it was still working. Indeed, that single "kinetic" permanent magnet destroys all objections to  $COP > 1.0$  EM systems, including those that are self-powering and thus have  $COP = \infty$ .

It seems little known that the vacuum around nuclei, in some cases, can be treated as a semiconductor, e.g. as discussed by Prange and Strance {365}. It is also known that nuclei do exhibit resonances at ELF frequencies. In particular, the vacuum in the region close to the nucleus of a superheavy element is known to act in a fashion analogous to the inversion layer in a field effect transistor. Prange and Strance introduce the idea of the inverted vacuum. Just as a semiconductor may be manipulated by subjecting it to external fields, doping etc., it appears that the vacuum can be similarly manipulated by appropriate means. We personally suspect that the semiconducting vacuum can be and is resonantly involved in any ELF resonances of the nucleus, which can occur in lighter nuclei such as barium.<sup>164</sup>

The virtual particle flux of vacuum, regarded as noise, may provide noise amplification of the coherent self-oscillation frequency between the semiconducting vacuum and the barium nucleus. Certainly, analogous noise amplification of signals is known in electrical physics {366}.

<sup>164</sup> Here our concept of the supersystem may be of utility. The "lock-in" or "freeze-framing" of an equilibrium condition for a system — such as in a state of nuclear ELF self-oscillation — is stabilized and made a "new equilibrium condition" when the force field reaction from the curved local spacetime into the system is equal and **opposite** to the force field reaction from the local active vacuum into the system. We believe Sweet's undisclosed activation process was a method for synchronizing those two force field reactions and making them equal and opposite in one short discharge. We hope that this speculation is of use to future experimenters trying to duplicate Sweet's activation of his magnets into sustained and powerful supersystem self-oscillation.

I hypothesized that Sweet's activation process treated the vacuum surrounding the barium nucleus in such fashion, so that he was able to establish self-oscillation between the local activated vacuum and the concomitantly activated barium nucleus. Since barium ferrite is optically active, it may be that Sweet discovered how to get sufficient "self-pumping gain" for the self-oscillation to endure and not die away in a decaying oscillation manner. Since the "gain" of the second VTA as a self-pumping device was some 1,500,000 (Figure 6-8), obviously Sweet's activation method introduced a powerful state of self-oscillation.<sup>165</sup>

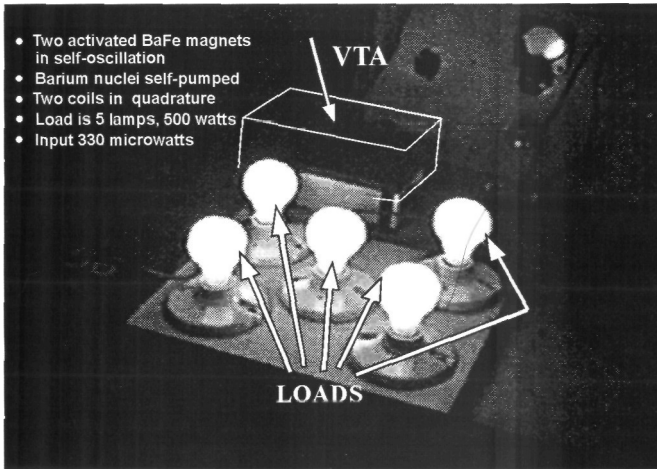

Figure 6-8 Second Sweet VTA producing 500 watts and COP=1,500,000.

<sup>165</sup> Here we point out that "small" things with very close "double surfaces" of opposite charge or potential usually have very large fields. The tiny Lamb shift, e.g., has a local energy density greater than the surface energy of the sun. Jackson, *Classical Electrodynamics*, Second Edition, 1975, p. 10-11 points out that "field strengths of the order of  $10^9$ - $10^{15}$  volts/cm exist at the orbits of electrons in atoms, while the electric field at the edge of a heavy nucleus is of the order of  $10^{19}$  volts/cm." It should be obvious to the reader that, if our speculation is true and nuclear oscillation of the barium nuclei is involved, the production of optical gains of  $1.5 \times 10^6$  in Sweet's self-pumped, optically acting barium ferrite magnets is not surprising because of the extreme magnitude of the oscillating nuclear fields. In that case, optical gain converts directly to true power gain because the pumping energy is furnished freely by the environment and not by the experimenter.

### 6.3.2.1 Mapping the Magnetic Field of the Magnets

Figure 6-9 shows a small magnetic field mapping device built by test engineer Rosenthal for Sweet. Sweet "scanned" and mapped the consistency of the magnetic field from his candidate magnets (barium ferrite magnets bought from surplus stores at the time). If the consistency varied over 12 to 15%, the magnet was useless because it would not "hold" the activation and retain it. Magnets whose magnetic field variation did not exceed 10% were ideal. So Sweet only found about 1 in 10 or even 1 in 30 magnets that would retain the self-oscillation state when initiated.

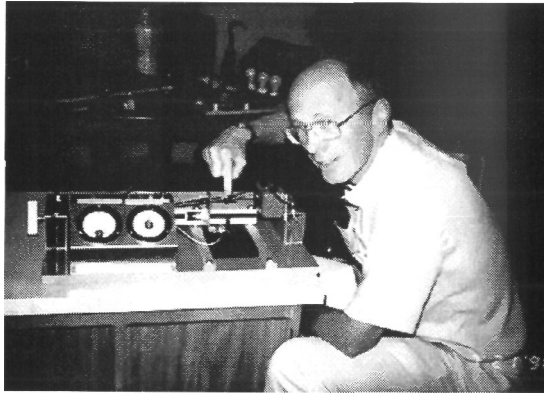

Figure 6-9 Test engineer Rosenthal points to a magnetic field strength mapping device he built for Sweet.

Sweet may have actually used two appreciably higher frequencies in his activation process, with the difference frequency between them being a precise ELF frequency (60-hertz, 100-hertz, 400-hertz, etc. as he desired).

That would make sense, when one realizes that the magnet is a highly nonlinear medium and then treats it (to first order) as an isotropic nonlinear medium. In that case, the two wave frequencies actually used would be subject individually to the normal overshoot, breakup, reconstitution, etc. inside the material of the magnet — but the difference frequency would behave as if it were a sine-wave frequency {367}.

This makes sense, since the output wave of Sweet's activated magnet was essentially a pure sine wave. Also, the presence of noise-enhanced heterodyning can sometimes be used to amplify a difference signal even further {368}. As we stated, since the activation is a self-oscillation between the local semiconducting vacuum and the barium nuclei, one wonders whether much of the rest of the vacuum virtual particle flux can

be treated as noise, and whether an effect is obtained for noise amplification of the coherent self-oscillation frequency.

L'vov and Prozorova {369} point out some interesting characteristics of the formation of self-oscillating spin waves which occur above parametric excitation. These oscillations result when internal stability does not occur, and they evidence themselves as oscillations of magnetization. The frequencies of the oscillations usually lie in the range from tens of kilohertz to tens of megahertz. At small above-threshold ratios, the shape of the oscillations is nearly sinusoidal. At larger ratios, the shape differs appreciably from sinusoidal. At still larger ratios, the oscillations become chaotic.

If Sweet did use the "difference frequency" conditioning, one suspects he may thus have been able to utilize larger above-threshold ratios, where the two frequencies actually transmitted would have resulted in chaotic oscillations. It is interesting to speculate that, in that case, for a suitably chosen barium ferrite magnet, the difference frequency still can behave sinusoidally, but now much stronger. If so, that might account for the tremendous COP Sweet attained in his second unit, which exhibited a  $COP = 1.5 \times 10^6$ , and could be pushed even higher.

#### ***6.3.2.2 Sweet VTA for Closed-Loop Self-Powering Operation***

Courtesy of Walter Rosenthal, we now present a visual record of the Sweet closed-loop self-powering version of the VTA and its momentous successful acceptance test on May 1, 1990, as closely observed by Rosenthal.

Figure 6-10 shows Sweet and a different version of the VTA, with the coils in a slightly different configuration and the windings altered. This is the two-magnet, 2-coil VTA that he built and tested for self-powering operation. Figure 6-11 shows the unit mounted on a special test fixture built by engineer Rosenthal. This fixture and its components allowed the sensing of the sine wave output power at the zero-value crossover points. To switch in the special clamped feedback system for self-powering operation of the input, and simultaneously switching away from external power, the switching had to be done very accurately at that zero-point crossover. Feedback would not stabilize and hold if the switching were done at any other point in the output cycle.

Unit independently examined and testing observed by  
test engineer Walter Rosenthal

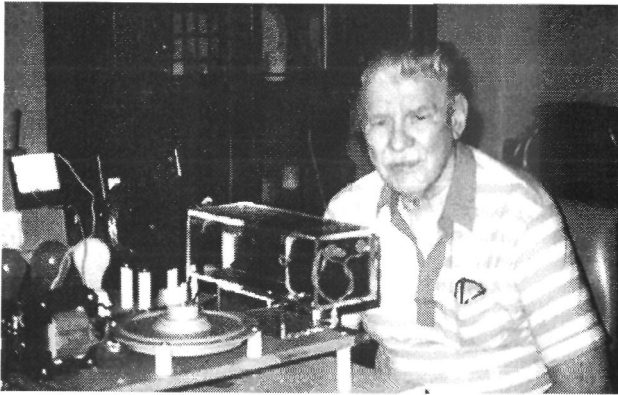

Figure 6-10 Sweet with 2-magnet 2 coil VTA, loads, and instruments for historic self-powering operational tests on May 1, 1990.

Figure 6-12 shows the set-up for the tests, with the unit and loads as well as some of the instruments used. Figure 6-13 shows the closed-loop VTA powering itself and its loads, after being initially set into operation with outside input power by the operator, and then adroitly switched into self-powering by switching the input from external to internal at an output

Fixture allowed unit to be started into operation on external power then switched to self-powering internal power at the zero crossing of the *output* voltage. The device in its fixture has a row of test points (disconnects) on every conductor going to the device

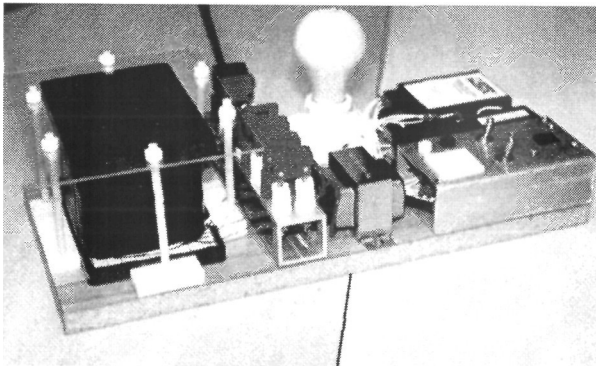

Figure 6-11 Two-magnet two-coil VTA mounted on a special test fixture built by Walter Rosenthal.



power zero crossover point. This picture shows the unit in self-powering and stable operation, taking all its input energy from the vacuum, including the power necessary to power its own internal losses and the power necessary to power its controls and loads.

Independently examined and testing observed by test engineer Walter Rosenthal

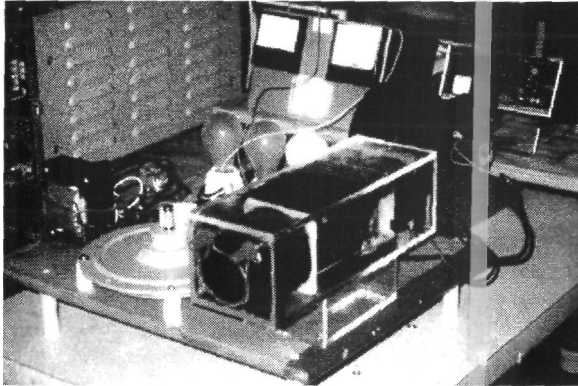

Figure 6-12 The 2-magnet, 2 coil VTA, loads, and instruments for its historic self-powering operational tests on May 1,1990.

Formal self-powering test on 1 May 1990 The loads and the VTA are powered by electrical energy extracted directly from the active vacuum Independently observed by professional test engineer Walter Rosenthal

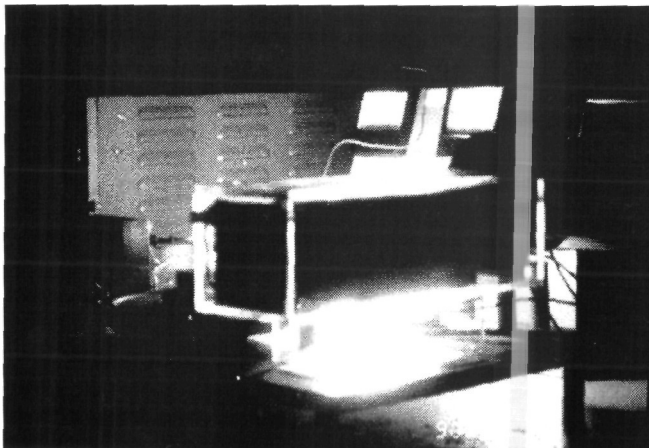

Figure 6-13 Historic self-powering operational test of the VTA May 1,1990 with no energy input by the operator.

We strongly stress that this operation is permitted by the laws of physics and thermodynamics for an open EM system far from equilibrium in its exchange with its active environment. The active environment in this case is the combination of the active local vacuum and the active local curvatures of spacetime. The closed-loop condition is a new and stable equilibrium condition in the dynamics of the mutual exchanges between all three supersystem components: the system, the active vacuum, and the curvatures of spacetime. The *system* is in stable disequilibrium; the *supersystem* is in a stable new equilibrium condition.

### 6.3.2.3 Discussion

We do know that the output current of the second Sweet device was comprised of a significant Dirac hole current<sup>166</sup> as well as electron current — showing the expected heavy involvement of the altered local vacuum (the Dirac sea) and the curved local spacetime. The negative energy majority of the output revealed itself readily. If the output leads were shorted, ice formed instantly on the shorted leads from the moisture in the air. That is, an electrical short resulted in the sudden production of cold (negative) EM energy rather than positive EM energy.<sup>167</sup> That can only occur if the majority of the output is negative energy, and any sudden surge in output (as from the shorted leads) increases the ratio of negative energy to positive energy so that very strong net cooling results.

For many predominantly mechanical components (simple electrical motors, light bulbs, etc.), Dirac hole current applied to the positive lead will power the circuit equally as well as electron current applied to the high voltage (negative) side, if the grounding is simply by a conductor and not a "vast reservoir" of charge. In such case, the wire chosen to conduct or direct the Dirac hole current should be made very small. It can and will

<sup>166</sup> We do mean hole current in the Dirac sea, consisting of Dirac holes in the vacuum itself, prior to their interaction with charged matter to form lattice holes in matter. We do not mean the standard lattice hole current at all.

<sup>167</sup> In local curved spacetime, Dirac holes constitute "negative energy EM fields and potentials". In such case, one can have negative energy entities and reactions analogous to positive energy entities and reactions in 3-space. On the time axis, one also has negative energy entities and currents, potentials, waves, fields, etc. Because **classical** Maxwell-Heaviside-Lorentz theory eliminates any modeling of the local vacuum or the local curvature of spacetime, these negative spacetime curvature (**negative** energy) potentials, fields, and currents have not been added into the electromagnetic theory. That of course is a serious shortcoming of the normal theory.

carry intense hole current and will cool rather than heat.<sup>168</sup> The wire to the electron side of the device should be made normal sized, appropriate to the electron current to be carried.

Several other inventors over the years have been able to activate a barium ferrite magnet into sustained self-oscillation of its material particles or domains, in similar but weaker fashion for varying lengths of time — up to a month or so in the longest time that I am aware of. Sweet's magnet would continue in self-oscillation indefinitely unless (i) the magnet was sharply shocked mechanically (as with a hammer blow), (ii) the magnet was heated to too high a temperature, (iii) the leads of the output circuit were electrically shorted, or (iv) external artificial field interference (electrical pulse shock, particularly from longitudinal stress waves) was encountered.<sup>169,170</sup>

Unfortunately, Sweet signed multiple conflicting agreements with several financial backers, and his work was legally entangled so deeply that it was never straightened. He eventually died, taking with him his activation secret. He was often threatened, and was once fired at by a professional

<sup>168</sup> This is very probably the secret of Tesla's "single wire system". At an exposition in Nevada, Bedini demonstrated just such a system, by powering 600 watts of audio speakers at the end of a long, very thin wire across the stage from his power amplifier. If he had been using positive EM energy, the wire would have instantly melted.

<sup>169</sup> During that period, the Russians were playing with earthquake induction via scalar interferometers, at various places around the world, including inside the U.S. heartland. Sweet's machine would sit above a natural quake and not be affected. But when a quake within many hundreds — even several thousands — of miles was artificially induced, the Sweet device would react to it. A fairly close artificially induced quake would destroy the self-oscillation of the magnets, and sometimes a very close artificially induced quake would actually explode the intensely activated magnets. So for several years one had a way of ascertaining which quakes were natural and which were artificially induced, by simply having Sweet confirm how his magnets interacted.

<sup>170</sup> For those who do not believe such an activity, here is a direct statement by then-Secretary of Defense William Cohen: *"Others are engaging even in an eco-type of terrorism whereby they can alter the climate, set off earthquakes, volcanoes remotely through the use of electromagnetic waves... So there are plenty of ingenious minds out there that are at work finding ways in which they can wreak terror upon other nations...It's real, and that's the reason why we have to intensify our efforts."* Quoted from DoD News Briefing, Secretary of Defense William S. Cohen, Q&A at the Conference on Terrorism, Weapons of Mass Destruction, and U.S. Strategy, **University of Georgia, Athens, Apr. 28, 1997.**

assassin using a silenced rifle. He survived the incident because, being old and a bit feeble, he stumbled and fell over the front steps just as the assassin fired. The bullet snapped by his ear, right where his head had just been. The incident was reported to the FBI, but with nothing else to go on, the assassin was never caught.

By whatever means, we do know that Sweet's magnets had to be activated by a special process that Sweet used and never fully revealed. An activated or "kinetic" magnet, it seems, was actually something a few of the "older magnetics guys" had known about, and Sweet had learned of it either from them or from Gabriel Kron. Sweet was also a transformer designer and expert, and he remarked that he had also observed specialized self-oscillation in certain transformers. Although most power engineers approached were either nonplussed or completely skeptical of a "self-oscillating field in a permanent magnet", self-oscillation of the fields, spin waves, etc. in permanent magnet materials *are* known to materials scientists today, especially to those working with magnetic effects in thin film materials {370, 371a-b}.

From a general relativity viewpoint, particle spin has a unique spin field of its own {372}, and there are such spin fields involved and operating in magnetic systems. The simple classical electrodynamic approach to magnetism and magnetic assemblies — or the view of a magnet as simply a bar with a north pole and a south pole — is quite insufficient when one wishes to research magnetic assemblies that will act as open systems far from equilibrium with their active environment, and thus will be capable of COP > 1.0 operations.

Recent work in coupled spins has revealed long-range coherence effects, previously unsuspected, as well as dual spin states participating in such phenomena {373a-b}. For example, Johnson has long used a 2-particle approach to spins and spin flipping in his own highly nonlinear magnetic assemblies {374}. His recent laboratory work has also shown similar and unsuspected *long-range coherence* effects in large multiple-magnet macroscopic systems {375} such as large assemblies of neodymium-iron magnets. This is strongly suggestive of the expected general relativistic spin field previously mentioned.

This work by Johnson is very important, since it may reveal a hitherto unsuspected mechanism for decay — of an otherwise nonconservative magnetic field around a closed loop — back into a conservative field. If one seeks an all-permanent-magnet rotating motor, a nonconservative magnetic field around a rotation loop must be established and sustained if

one is to have self-rotation and self-powering. A nonconservative magnetic field around such a rotation loop means that the system acts as an open system far from equilibrium with its active vacuum and active curved spacetime environment, by means of some asymmetry mechanism such as multi-valued magnetic potential {376a-c, 377a-g}, elucidation of exchange forces {378a-c} at selected positions and directions, etc. It also requires both a stable broken 3-symmetry and a stable 4-symmetry.

On the other hand, in our opinion, Sweet employed spin waves triggered into self-oscillation in the nuclei of the barium atoms in his barium ferrite magnets. Indeed, such nuclear spin waves in magnets have been known for some time {379}. We postulate that, as in any other COP>1.0 power system, a self-rotating all-permanent-magnet motor must also involve Dirac sea hole current interacting in the various magnetic components. It is reasonable to suspect that these also interact with the electrons and their spin fields, perhaps producing the active mechanism providing that observed long-range coherence that apparently can decay the nonconservative magnetic field around the rotation loop, causing it to revert back to a conservative field and thereby stop the self-rotation and self-powering. If so, that long-range coherence must be violated and the violation stabilized. However, we could find no papers in the literature that deal with such possibilities. Hence it is a subject for further investigation by COP>1.0 researchers.

#### ***6.3.2.4 The Highly Successful Anti-Gravity Test***

On one trip to California to work with Sweet, we noticed that, at full power output of 500 watts, his unit weighed a little less on the bench than when not powered. Struck by this anomaly, I considered the negative energy aspects of the output — as evidenced by the Sweet's demonstration of icing when the output leads were shorted — and the very high gain, which added up to a predominance of negative energy in the output.

Pondering this from a general relativity viewpoint, I reasoned that: (i) increase of positive EM energy density in space increases the curvature of spacetime to produce additional positive gravity  $G_P$ ; (ii) increase of negative EM energy density in space must increase the curvature of spacetime in the other direction, and thus it must produce negative gravity  $G_N$ , and (iii) the total gravity  $G_T$  produced in the immediate spacetime of an object producing both positive gravity  $G_P$  and negative gravity  $G_N$ , was  $G_T = f(G_P + G_N)$ . Thus if we increased the output of the VTA unit, we must inevitably increase the weight reduction (antigravity) effect since the predominance of the energy output was negative energy, and this output was in the neglected negative energy fields aspect as well as in the local

vacuum (spacetime) itself. After several back-of-the-envelope estimates and educated guesses over some weeks, I concluded that if the efficiency of the antigravity process<sup>171</sup> were 10% and the unit was pushed to 1500 watts output, it would lose all its weight and hover weightless.

However, because of the nonlinear local spacetime, magnetic monopoles<sup>172, 173</sup> were deposited in Sweet's magnets when the unit was

<sup>171</sup> We again accent the difference between efficiency and COP. Here we are definitely speaking of efficiency, not COP.

<sup>72</sup> Dr. Robert Flower has confirmed that the 'symmetrized" (or "extended") Maxwell equations (Eqs. 7.1 in Springer's *Encyclopedia of Physics*, Vol. 16, p. 431) include non-zero magnetic charges and magnetic currents. Antenna engineers (Henning Harmuth, and others) know that these terms must be included for proper description of boundary conditions, even though, at the final step of computation, their integrals are set equal to zero (apparently to snuff out magnetic monopoles). For Dirac's original theory of the monopole, see P. A. M. Dirac, "Theory of magnetic monopoles," *Phys. Rev.*, Vol. 74, 1948, p. 817-830. See also F. A. Bais and B. J. Schroers, "Quantisation of Monopoles with Non-abelian Magnetic Charge," *Nuclear Physics B*, Vol. 512, 1998, p. 250-294; G. Lochak, "The Symmetry Between Electricity and Magnetism and the Problem of the Existence of a Magnetic Monopole," in T. W. Barrett and D. M. Grimes. [Eds.] *Advanced Electromagnetism: Foundations, Theory, & Applications*, World Scientific, 1995, p. 105-147. Particularly see T. W. Barrett, "On the distinction between fields and their metric: the fundamental difference between specifications concerning medium-independent fields and constitutive specifications concerning relations to the medium in which they exist." *Annales de la Fondation Louis de Broglie*, 14(1), 1989, p. 37-75; — "Electromagnetic Phenomena Not Explained by Maxwell's Equations," in Lakhtakia, A. (ed.): *Essays on the Formal Aspects of Electromagnetic Theory*, World Scientific, River Edge, NJ, 1993, p. 6-86; — "The Ehrenhaft-Mikhailov effect described as the behavior of a low energy density magnetic monopole-instanton." *Annales de la Fondation Louis de Broglie*, Vol. 19, 1994, p. 291-301. The work of Ehrenhaft, which is now substantiated and thoroughly replicated by Mikhailov, has produced experimental evidence of the magnetic monopole in many replicable experiments. In these experiments, magnetic particles move in a magnetic field along the lines of force. Reversal of the magnetic field,  $H$ , causes a reversal of the magnetic particle's motion, which is not the case with magnetic dipoles, since that can only occur for a monopole. See V. F. Mikhailov, "Observation of magnetic monopoles in the field of a line conductor," *J. Phys. A: Math. Gen.*, Vol. 18, 1985, p. L903-L906; — "Observation of the magnetic charge effect in experiments with ferromagnetic aerosols." *Annales de la Fondation Louis de Broglie*, Vol. 12, 1987, p. 491-523. See also M. J. Perry, "Magnetic monopoles and the Kaluza-Klein theory," *Am. Inst. Phys. Conf. Proc.*, No. 116, 1984, p. 121-125; E. V. Smetanin, "Electromagnetic field in a space with curvature — new solutions," *Soviet Physics Journal*, 25(2), Feb. 1982, p. 107-111. [English translation]. See also T. T. Wu and C. N. Yang, "Dirac monopole without strings: monopole harmonics," *Nuclear Physics*, Vol. B107, 1976,

producing power, and the density of these monopoles varied as the output power. Increasing the power output thus increased the tensile stress of the magnets, and at some point they would explode into fragments, like a hand grenade.<sup>174</sup> This explained why conditioned magnets sometimes exploded when experiencing fluctuations from artificial earthquake induction testing.

Having no explosive control facilities, I warned Sweet not to push the unit past 1,000 watts, for safety reasons. At my urging, Sweet made a new output load often 100-watt lamps in sockets, so the load could be varied from 100 to 1,000 watts easily.

p. 365-380; — "Dirac's monopole without strings: classical Lagrangian theory," *Phys. Rev. D.*, 14(2), July 15, 1976, p. 437-445.

<sup>173</sup> We emphasize that a magnetic monopole can be taken simply as a highly localized magnetic scalar stress potential. See, e.g., P. A. M. Dirac, "Theory of magnetic monopoles," *Phys. Rev.*, Vol. 74, 1948, p. 817-830. Dirac pointed out that the existence of a single magnetic monopole in nature would allow an explanation for charge quantization. We believe that the reverse of Dirac's argument may be true also: The existence of charge quantization should allow an explanation for the magnetic monopole. However, we also surmise that a magnetic monopole exists only in (and as) a sharply localized curvature of spacetime. Jackson, *Classical Electrodynamics*, second edition, 1975, p. had this to say about magnetic dipoles and Dirac's argument: "*Dirac's argument... is that the mere existence of one magnetic monopole in the universe would offer an explanation of the discrete nature of electric charge. Since the quantization of charge is one of the most profound mysteries of the physical world, Dirac's idea has great appeal.*"

<sup>174</sup> Sweet in fact did explode several magnets by pushing the power output of the device. Pushing the output was easy (and is easy for any unit outputting mostly negative energy), because all one had to do was connect additional load.

ENERGY FROM THE VACUUM: CONCEPTS & PRINCIPLES.

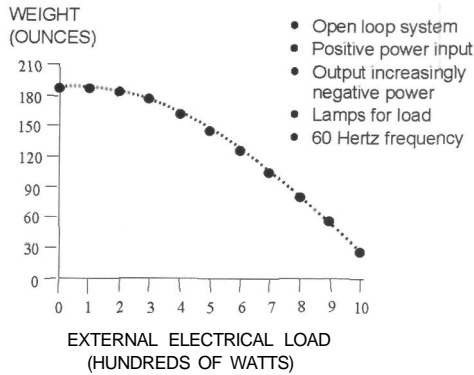

Figure 6-14 Results of the "pushed" VTA antigravity test: Weight of VTA on the bench versus power output.

Sweet completed the new load section and performed the experiment in California after I had returned to Huntsville, reading off the results to me over the phone. I took down the data, and then plotted the curve. Figure 6-14) shows the beautiful results. At 1,000 watts the unit had lost 90% of its weight. This was electrifying, because it was an unprecedented and highly successful antigravity experiment. Even my original "rough" assumption of levitation at 1500 watts was not too far from the indicated 1250 watts or so from the actual curve.

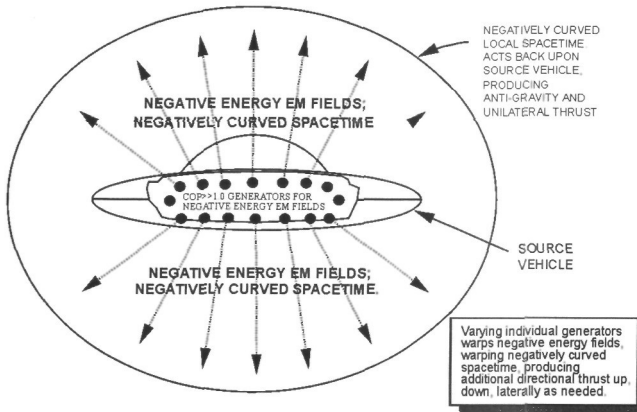

Figure 6-15 Proposed mechanism for practical antigravity.



Figure 6-15 shows my proposed mechanism for antigravity. We simply use negative EM field energy generators to produce a negative EM energy field in space surrounding the source vehicle. The associated positive energy from the same energetic power source can power the vehicle simultaneously. The local reversed curvature of spacetime now interacts back upon the mass of the vehicle, to produce an antigravity component. By adjusting the output of the power source, the amount of negative energy — and hence the amount of antigravity component — can readily be varied and controlled. By controlling the directions of the field components, one can have unidirectional antigravity force, or antigravity and thrust force vectors simultaneously. Hence such a vehicle could be maneuvered and controlled, and be self-powering. This at least was and is my concept of a practical antigravity technology.

#### *6.3.2.5 Later Developments and the End of the VTA*

Later I prepared a paper on the VTA, including the antigravity experiment's results. We succeeded in getting the paper published {380} but I deliberately did not include the real details of the negative energy aspects as I wished to withhold that information for patenting. I prepared the entire paper, but placed Sweet's name first, as was appropriate since he was the inventor of the VTA.

Unfortunately — but understandably! — Sweet became a bit paranoid after the sniper assassination attempt (he was shot at by a distant sniper using a silenced rifle), and then would never allow a formal demonstration of his antigravity test. I strongly wished to present it to a major national U.S. scientific committee for independent testing and confirmation — which could have been done without Sweet having to reveal his activation process for the magnets. However, Sweet would not hear of such. Indeed, he fearfully kept the antigravity capability a secret from most of his backers. He strongly believed that he would be killed almost immediately if he revealed our antigravity experimental success. He may have been correct.

In fairness, the inventor and his backers of necessity have different priorities from those of scientists doing open research in a university. But at least a record of the test results is in the literature, though certainly not as rigorously or as extensively as I wished. Sometime later, I withdrew from any further association with the VTA unit, after the backers changed, a lawsuit broke out, and the entire project unraveled. Sweet later died without ever revealing his full secret for such powerful activation of self-oscillation in permanent magnets at low ELF frequencies.

The loss of the Sweet vacuum triode was a severe blow to science and a real setback to the scientific progress that could already have been made. Nonetheless, I contributed what I could, documented what I could, and made a videotape of the operation of the open-loop 500-watt device in the power mode. I also made a video of as much as Sweet would reveal of his activation process. I was not allowed to videotape a second antigravity experiment, even though I frequently and strongly requested it. By that time, Sweet mortally feared for his life. Perhaps what we have written in this book will be sufficient to provide some needed clues to some future graduate student or post-doctoral scientist who will succeed in recovering the necessary activation of magnets and both the COP»1.0 power capability and the antigravity experiments.

Meanwhile, I have filed a provisional patent application on the mechanism for antigravity, the gist of which I worked out solely on my own back in 1971 at Georgia Institute of Technology, and that I include in Chapter 8. As far as I am aware, no one else had thought of it previously, or has thought of it in that exact form *{using the causal positron prior to observation, and while it is still a negative energy, negative mass electron, as the source charge for negative EM field energy, and also using the causal positron's corresponding giant Heaviside nondiverged negative energyflow for substantial negative curvature of spacetime.}*

### **6.3.3 Intense Discharges in Ionized Gas**

Intense sudden discharges in ionized gases are especially of interest due to the presence of optical frequency components and the involvement of iterative optical retroreflection etc. These processes seem to be involved in several investigations and inventions. Further, it appears that such intense discharges do produce bursts of negative EM energy as part of their overall discharge energy.

In the case of plasmas, some are known to transduce an input transverse EM wave into an output longitudinal EM wave, and vice versa. We know now that such a longitudinal EM wave is also accompanied by a time-polarized (scalar) EM wave in the time domain. The connection with the Whittaker 1903 decomposition of the potential, and with the new 4-symmetry negentropy law, is apparent. Several COP>1.0 researchers — notably Shoulders {381a-f} and Paulo and Alexandra Correa {382a-e} — have performed extensive research into anomalous discharge phenomena, and also have developed experimental devices capitalizing on the novel

effects available.<sup>175,176</sup> The Correas' U.S. Patent No. 5,449,989 includes many tests of a Correa glow discharge apparatus, one of which in 20 minutes of operation produced 0.988 kilowatt-hour of energy output for an input of 0.258 kilowatt hours. Using the known negative resistor characteristics, the Correas achieved sustained self-oscillations in the discharge.

As an aside, we point out that the well-known anti-Stokes emission — which produces more energy output than the experimenter inputs, and hence exhibits  $COP > 1.0$  — has long been validated in certain gases such as aniline vapor {383} and  $H_2$  {384}. Stimulated anti-Stokes radiation occurs in many solid materials such as oxides and doped oxides {385}. Assuming the excess energy comes from the internal energy of the molecules, this is a prime candidate for free replenishment of that furnished internal energy of the molecule, via the broken symmetry of the molecular dipoles in their fierce virtual energy exchange with the local active vacuum and local curved spacetime. Of course, conventionally the energy furnished by the molecules, etc. is not replenished from the vacuum, hence anti-Stokes emission can be used for coherent light cooling effects {386}. Apparently the Correas' process accomplishes the energy replenishing, hence the  $COP > 1.0$  performance over a 20 minute period.

Formation of longitudinal EM waves in the plasma forms in certain gas tubes, such as Priore's gas-filled tubes {387}, may also occur in the Correa experiments and probably do. Longitudinal EM waves, of course, always involve their concomitant, accompanying time-polarized EM waves, since the combination comprises the scalar potential and hence the local curvature of spacetime provided by that scalar potential. The replenishment mechanism involved in longitudinal EM waves and scalar potentials — time-energy transduced into 3-space energy — apparently is

<sup>175</sup> Both Shoulders' electron cluster discharges and the discharge phenomena of Paulo and Alexandra Correa have been independently verified. Fox and other scientists have verified  $COP > 1.0$  in Shoulders' work, and Mallove has formally observed a self-powering Correa system. Both these highly reputable scientists are well known, have the highest integrity, and I would trust either of them with my life. Further, we point out that strong gradients — as exist temporarily in strong discharge phenomena — are already known to violate thermodynamics. That is one of the areas being researched today to advance thermodynamics, under the aegis of "extended thermodynamics". See Appendix A.

<sup>176</sup> In addition, the Correas have demonstrated a form of energy that demonstrates latent heat. See discussion in Paragraph 6.3.9.

invoked and utilized in the Correias' sustained self-oscillations in the plasma discharge.

#### 6.3.4 Shoulders' Electron Cluster Processes

Valone {388} has summarized Ken Shoulders' charge clusters and processes as follows:

*"An unusual energy source is the clustering of electrons by a discharge needle into a high density bundle equaling Avogadro's density of a solid.... Ken Shoulders has patented a process (Pat. #5,153,901) that produces electron clusters with such high energy density, they equal processes exceeding 25,000 degrees Celsius upon impact. Yet, he only uses 20 microjoules to produce the effects. The clusters travel at a maximum of one tenth the speed of light and penetrate any substance with accuracy and sharp precision. It is similar to xenon clustering techniques currently used at megavolt energy levels. Low energy nuclear transmutation of the target has also been achieved with this process. Using a deuterium-loaded palladium foil, only the bombardment areas show transmutation into silicon, calcium, and magnesium with electron clusters upon analysis with X-rays. Jin and Fox {389} have postulated that the high velocity electron clusters achieve results similar to accelerators, including penetration of the nucleus, with substantially less power. The new physics of like-charges clustering in bundles under low power conditions opens a wide range of applications including spacecraft maneuvering microthrusters. Overunity efficiency [sic: should be COP] is 9 to 1, or higher. "*

**Ken** Shoulders is an accomplished experimental scientist who has discovered and patented many aspects of electron charge clusters, including their COP > 1.0 characteristics {390}.

According to his experiments, one of the most remarkable characteristics of these charge clusters seems to be their dramatic reduction of the permittivity of space {391}. Shoulders has noted the remarkable removal of **positive** charge during the self-formation process of the clusters {392}. In our opinion, the involvement of the supersystem of these charge clusters is shown by that phenomenon. We hypothesize that an accompanying Dirac hole current is shown by the experimental occasions where — in

addition to the Shoulders' negative charge clusters — additional charges unite but show effects of having opposite charge {393}. Such changes would change the permittivity of space, which Shoulders has noted. They could also create a time-reversal zone (TRZ), which would account for the clustering of like charges since in a TRZ the law of attraction and repulsion of charges is reversed. In such a zone, like charges attract and unlike charges repel. This could explain why Shoulders has observed both negative charge clustering and positive charge clustering.

This would also explain the remarkable separation of the positive charges from the negative charges — they are simply *repelled* by the negative clusters in a TRZ.<sup>177</sup> This of course immediately involves curvature of spacetime effects, including local changes in the speed of light etc. As stressed by Shoulders, the entire area cries out for extensive and sophisticated experimental investigation on a continuing basis, as well as some powerful new theoretical work. Shoulders has also noted both "black" and "white" (dark and bright) clusters, including their combination and separation, strongly suggesting Dirac holes as well as the electrons in the charge clusters. He has proposed a form of "inertial propulsion" based on some of the mechanisms and asymmetrical forces observed in his experiments, and such asymmetry is possible in curved local spacetime conditions.

The relation of Shoulders' effects to cold fusion phenomena was shown by an experiment in which a deuteron-loaded palladium cathode was impacted by a charge cluster {394}. An explosive-like reaction occurred, and an X-ray analysis of the impact crater showed a number of elements not seen in the nearby palladium surface away from the impact site. Elements such as oxygen, calcium, silicon, and magnesium were detected in the impact site, but not in the surrounding palladium lattice. We would suggest the presence of TRZ-based nuclear transmutation reactions (via quasi-nucleus formation followed by quark-flipping in nucleons as the

<sup>177</sup> Since the same TRZ phenomenon generates specific nuclear transmutation reactions at low spatial energy, explaining the anomalous transmutation of elements in cold fusion electrolyte experiments, a strong indication exists that it is a viable mechanism. In our mechanism proposed for the flow of time, a TRZ is produced for charges whenever antiphoton interactions predominate over photon interactions. This indeed implies a change in the permittivity of the local space, local curvature of spacetime, and local changes in the speed of light — all phenomena Shoulders notes in his experiments.

TRZ decays to a time-forward zone). Additional information on this charge cluster phenomenon has been given by Fox {395}.

Other Shoulders patents are pending and his research is continuing. It is our understanding that at least one application is presently being developed for the market.

### 6.3.5 Mills's Hydrino Energy Cells and Developments

Dr. Randell Mills {396a-396c}, {397} has proposed a cosmic sea of hydrinos (the hydrino is a proposed reduced energy state of the hydrogen atom) to explain his tested energy cells. He envisions — and produces a theory for — hydrogen that is reduced to a lower energy state (the "hydrino"). He has gathered considerable evidence for his theory, and has accounted for some sixty or so infrared spectral lines in the sun's radiation that have previously not been explained. Independent tests appear to have validated his energy production claims.

Several major companies are presently working with Mills and his parent company, BlackLight Power, Inc. Progress can be followed from the company website, [www.blacklightpower.com](http://www.blacklightpower.com). Developments are ongoing in light, power, plasma, and new compositions of matter. A technical book by Mills {398} is freely downloadable from the website, giving his overall theory, as are other publications by Mills *et al.* {399a-h}. Critical objections to various parts of Mills' theory have been given, e.g., by Zimmerman {400}, with Mills responding strongly and — in our opinion — successfully.

Certain concepts utilized by Mills are, in our opinion, valid and insightful - whether or not the classical quantum mechanics developed by him is found to hold, and whether or not it agrees with ordinary quantum mechanics (which has problems of its own). The point is that *the experiments work*. It is thus the job of the theorists to find what changes must be made to the theory for it to remain consistent with experiment. If they do not like Mills' theory, the proper procedure is to advance one that **is** consistent with all the experimental results, and also to show where Mills' theory is inconsistent with the results.

In our own view, an *observed* positive charge is the output of an ongoing time-reversal process and therefore represents a "time-reversed entity" as observed. Before observation (imposition of  $d/dt$  operator), the positive **charge** is thus a negative 4-charge comprised of  $qt$ , not  $q$ . From that viewpoint, the  $H^+$  ion, which is just a hydrogen nucleus (a proton) without an electron shell, may be regarded as a time-reversed 4-entity prior to observation. Further, any energy change in and of the hydrogen atom

results in a change in the local energy density of spacetime (ST) *a priori*, hence a change in the local ST curvature.

If we regard the entire hydrogen atom as a set of such ST curvatures and their dynamics, then Mills' consideration of a lower positive energy state *hydrino* simply implies the addition of an additional negative ST curvature to the ST curvature set associated with the normal hydrogen atom. We note that binding energy of the nucleons is already negative energy, and thus just such a negative spacetime curvature. But the binding energy is itself a spacetime curvature *capable of being increased*, as can be any spacetime curvature. In the supersystem, addition of such ST curvature is possible, and it is *doable* electrodynamically, particularly when Heaviside's normally unaccounted huge energy component is accounted and utilized.

In our opinion, Mills' theory should probably be recast into a higher group symmetry electrodynamics — such as  $O(3)$  — which has been shown to be intimately connected with Sachs's unified field theory. This would provide an adjusted model that is not only testable but also *engineerable*. Nonetheless, the concepts of Mills' theory and the theory should be closely examined as they stand, and at least some of the key concepts are engineerable as witnessed by his successful experimental results. That is better than what the critics have offered! A higher group symmetry recasting would enhance and expand his theory even more, and correct any errors that might be present. It would also allow a full theoretic treatment (i.e., a supersystem treatment) of Mills' main concepts, which we believe have much merit.

Further, given Mills' hydrino as we approached it, two hydrinos will each possess such a set of spacetime curvatures (each will possess such a *vacuum engine*). Later in this book — and elsewhere {401} — we have pointed out that, in a time-reversal zone (TRZ), the law of electromagnetic charge attraction and repulsion is reversed. Accordingly, in a TRZ two or more hydrinos will attract each other so closely that each enters the now-reduced strong force region of the other, forming a quasi-nucleus. As the TRZ decays away back to a normal time-forward zone, because of their power law form the strong forces restore back to normal much faster than the electromagnetic forces do. Hence during its "decay", the quasi-nucleus is energetically compacted into a permanent nucleus, either flipping quarks or giving off one or more particles as necessary to balance its new energy state in the process. We have previously argued that a similar process where a TRZ induces formation of quasi-nuclei also yields the major transmutations {402} demonstrated in a large number of cold fusion experiments worldwide.

The present author has previously proposed an engineerable mechanism (the totality of all photon interactions with a mass) that generates the flow of that mass through time {403}. By manipulating the arrow of time between forward vector and reversed vector, the strong forces in a nucleus (or for a particle) can be directly manipulated in magnitude (and to some extent, even in sign although the latter involves gluon and quark manipulations in the nucleons). By adroit use of these manipulated strong forces and TRZ formation and decay, the energy states of nuclei can indeed be manipulated, including reduced in energy level —just as Mills assumes and presents experimental evidence for, and as cold fusion experiments present experimental evidence for.

We note that two such interacting hydrinos must each possess a specific vacuum engine (specific set of ST curvatures and dynamics). Novel new interactions are available in TRZ's because of manipulation and even reversal of electromagnetic forces, strong forces, etc. and because of nuclear fusion of like charged particles into quasi-nuclei followed by decay into stable nuclei, etc. These novel new particle interactions caused by manipulation of strong spacetime curvature engines and their magnitudes are presently missing from particle physics. Mills, however, does come at them from a somewhat different direction in his own concepts.

The reason for the absence of dominant general relativity effects in most particle physics is that the "total photon interaction" mechanism generating the flow (persistence) of a mass or field through time has not been recognized and used. Consequently, in general only those far weaker ST curvatures due to the weak G-force have been considered. To Mills' great credit, he is aware of the gravitational significance of manipulating much stronger forces and spatial energy densities such as the electromagnetic fields and their energy densities.

The U.S. Patent and Trademark Office then refused a new patent to Mills on one of his processes, and revoked another Mills patent even after already agreeing to award it within two weeks. BlackLight Power, Inc. initiated and lost a lawsuit against the Commissioner of Patents, seeking to reverse this unusual action by the U.S. Patent Office. However, the company's patent portfolio has continued to grow, with extraordinary international applications {404a, 404b}, and several European patents have been filed appropriately. BlackLight Power Inc. seems well funded (some millions of dollars) and well staffed, and we expect to see BlackLight Power, Inc. products entering the market place. Those products will



probably be related to fuel cells, plasmas, power converters, generators, separation methods, and novel compounds materials.

and

### 6.3.6 Switching Circuits with Extended Electron Gas Relaxation Time

See Figure 6-16. Suppose an instantly applied voltage to the high side of the circuit instantly potentializes a pair of circuit conductors, with the other acting as ground. The charges in the conductor are thus instantly potentialized and excited, so that through the external circuit there exists an E-field  $E$ , where  $E = -\nabla\phi$  between the high side of the circuit and the ground return side. An acceleration force on the energized electrons thus exists. It requires a finite time for the energized electrons in this force field  $E$  to break their static friction or inertia, move, and accelerate to the requisite slow drift velocity down the wire. During that delay or "electron relaxation time", no current is initially in progress, then a little current is flowing, and finally all of the current is flowing. This delay time is called the electron gas relaxation time.

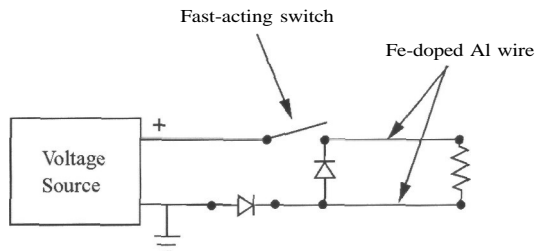

Note: May use many strands of Fe-doped Al wire instead of one, for each conductor

Figure 6-16 Extended-relaxation-time circuit with diodes.

In the usual copper conductor, the delay time arguably may be on the order of  $10^{-16}$  sec. This is so slight a delay that it can be ignored, for all practical purposes. Current — with resulting dissipation of the collected potential energy — usually occurs "as soon as" we apply the voltage, for all practical circuit work. However, suppose we could increase that electron gas relaxation time to, say, one millisecond? Then for an appreciable number of microseconds, there would be essentially no current flowing at all in the now-potentialized circuit.

We previously proposed a mechanism whereby a degenerate semiconductor alloy (say, of a tiny bit — perhaps 2% or so — of iron

alloyed in aluminum wire) is utilized for the conductors of the external circuit. This should give a vastly extended electron relaxation time, somewhere on the order of a millisecond. By obtaining a millisecond, one can excite the circuit with current-free potential alone, which becomes pure regauging during the electron relaxation period.

We strongly point out that this is an asymmetrical regauging; the E-field previously mentioned is present, but the electrons are still frozen in the circuit since their relaxation has not begun. The gauge freedom principle, recognized in quantum field theory, assures us that we do not have to perform work to simply inflow potential energy to change the potential energy of the system. In real circuits, we may have to pay a tiny bit for switching to connect and disconnect the external potentialization source, but we can be at pains to make that very efficient and minimal {405}. The point is, other than minor switching costs, the dramatic change in the potential energy of the system is cost-free and no current is drawn from the external potential source. Hence — in the language of the electrical engineer — we draw no power from the source of potential, during this potentialization time.

Suppose we switch away the excitation source prior to its decay while the electrons are still frozen. Simultaneously, we complete the "freed" potentialized circuit with a strategically placed diode, as shown in Figure 6-16. Again, we pay a little switching cost, but it can be minimized. The electrons in the *now asymmetrically potentialized circuit* are still frozen, so no power has yet been drawn by the system from the external power supply furnishing the voltage only. In this way, pure asymmetrical regauging is used to excite the circuit with additional potential energy, without requiring work (except minimally for switching).

A little more time passes, and suddenly the electrons in the potentialized circuit wake up and move. We stress again that the full emf is acting on the electrons, and now they are finally free to move. There is a net nonzero regauging E-field (force field) also. The excited closed current loop circuit then discharges in normal Lorentz symmetrical fashion, killing the source dipolarity as current is driven back up through the diode, but all the work in the load is "free". The circuit specialist will also recognize the usefulness of additional components associated with the shunt, such as a capacitor or even an LC oscillator for AC work.

If  $LE$  is load work obtained and  $SE$  is switch energy utilized, this approach yields  $COP = LE / SE$  and  $COP > 1.0$  is possible. The reason is that the *primary* source dipole providing the potential for potentialization of the

electrons and re-gauging of the circuit is removed from the closed current loop circuit and the effect of current through the back emf. Thus the primary source dipole is not destroyed faster than the load is powered. It is only depleted by the small amount of switching energy we utilized. This appears to be a major way to avoid the  $COP < 1.0$  limitation of the usual closed current loop circuit.

This is a circuit with legitimate  $COP > 1.0$  capability, without violation of the laws of thermodynamics or physics. We break the Lorentz condition between the initial "external circuit" and the primary source dipole for the re-gauging energy. After re-gauging, we "cut loose" the circuit with its own primary dipolarity and newly transferred "separate source dipole". *By such adroit use of electron gas relaxation time, we can use one source dipole to freely make another of equal intensity, without any depletion of the first.*

The difficulty is in getting the Fe-Al alloy wire, which must be made in an inert atmosphere since Al corrodes easily and the two elements have very different melting temperatures.

Alternatives can be visualized, such as to utilize a capacitor whose plates are made of the Fe-Al alloy. This might be useful in the triode-capacitor, to be discussed next. A series of pulses might then be used to charge the capacitor, without depletion of the primary source dipole in the external source of potential, if it is repeatedly switched in and away. An interesting question arises if such a capacitor with tailored "hysteresis" in its charging is utilized in various circuits and schemes containing a coil of useful time delay also, particularly since the electron gas relaxation phenomenon involves decaying oscillations. Interesting phase angle results can be constructed in such circuits, but we leave the resolution of this question to future experimenters.

### **6.3.7 The Triode-Capacitor and Other Curious Components**

See Figure 6-17. In this rough concept by the present author, the notion is to implant a grid of very small copper wire mesh inside the dielectric and near one or both of the capacitor plates, and then to utilize grids as if they were grids of a triode tube, for gating and controlling the displacement current in the capacitor and the dielectric strain. As an example, when charging the capacitor, the grids can be used to increase the displacement current (which also increases the voltage on the capacitor and dielectric strain). This increases the charge and energy in the charged capacitor, without putting in as much "enhancement and gating" energy as the extra energy obtained in the charged capacitor. If desired, we can also

incorporate the 2% Fe-doped Al wires in the grid, or connected to it, to further move the grid toward a "pure current-free potential" operation.

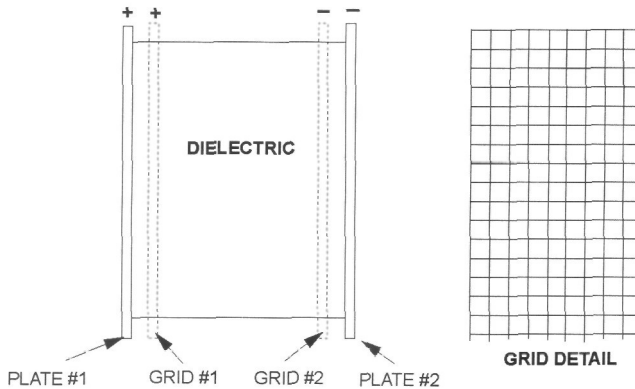

Figure 6-17 The triode-capacitor concept.

The scheme is that a voltage on this grid will intercept only a small current during charging of the capacitor, but can have an appreciable voltage upon it. The charging potential is placed across the capacitor, and simultaneously the grid has a similar potential placed upon it. The external source of charging potential is then disconnected, and the capacitor charges with more energy rearranged in its circuit than the energy one dissipates in the grid. The similarity to an old vacuum tube triode is apparent. For the purist, additional grids with tetrode and pentode functions can also be added.

One or more inventors has unwittingly tried to approach this in one way or another, but have not directly incorporated this schema and have not used the grid. They do not seem to have obtained positive results with those different schemas without the grid, nor have they specified the difficulties and phenomenology encountered, etc. We were curious about possible results of combining this (the triode grid in the capacitor) with the known elimination of capacitor losses by appropriate pulse charging {406a-b}. It seems that experimentation and research with the triode capacitor and its variations is definitely indicated.

We were also curious about the Davis non-inductive resistor {407a}, which is a special kind of "capacitor" that becomes an inductance-free resistor. One may argue that the resistor may be multiply inductive after all, though it is *net* noninductive. It may well be "equally and oppositely

inductive," which is quite a different thing altogether, since it produces an artificial stress potential (and in the presence of AC, it produces a longitudinal EM stress field wave) in spacetime even though it produces a *net* zero reactance. In short, it produces a Lorentz-regauging, directly, and this can be a varying Lorentz regauging producing longitudinal EM stress waves. Whether this odd characteristic can be utilized in a COP>1.0 process remains to be seen. Preliminary indications are that it can be so utilized.

The various versions of the biwound coil, wound with two conductors at once and then the currents passed through the conductors in opposite directions, also presents interesting capabilities. Here again, it is multiply inductive, but may be tuned and adjusted to be *net* noninductive. We strongly suggest comparison with the well-known hairpin dual dipole antenna.

In short, this biwound coil arrangement — with various variations — can produce (and modulate) a magnetostatic scalar stress potential in the local vacuum and, in the case of AC, a longitudinal EM wave. This would appear to be a direct change (and oscillation) of the stress potential of the vacuum itself, which can be decomposed via the Whittaker process into a harmonic set of phase conjugate longitudinal EM wavepairs. The potential longitudinal EM wave communication possibilities can be seen, although one might require a Fogal transistor to receive the longitudinal EM wave modulations of such signals.

Further work in this area of unusual capacitors and components is left to the interested reader for his or her experimentation and research.

### **6.3.8 A Surprising Thing About Thermodynamics and Reservoirs**

Thermodynamically, it is fashionable to state that one cannot take energy from a reservoir at constant temperature. That is true for *equilibrium* conditions, but not for *nonequilibrium* conditions {408}. That is, we cannot take energy from a reservoir *in equilibrium* at constant temperature. We can indeed take energy from a reservoir at constant temperature *but not in equilibrium*. More exactly, we can take energy from a nonhomogeneous reservoir at constant temperature.

We quote Hsu-Chieh Yeh {409} for a vivid statement of this little-recognized fact:

*"From Planck's statement of the second law of thermodynamics it is generally inferred that it is impossible to construct an engine which produces work at the expense only of heat taken*

*from the air or the ocean. ...[It is demonstrated that]... when the air and the ocean are combined as a nonhomogeneous reservoir of uniform temperature, it is possible to construct an engine which produces work by extracting heat from the said reservoir. This does not constitute a violation of the second law of thermodynamics, rather that the "reservoir" in the Planck's statement must be clearly stated as being in equilibrium. "*

Yeh's article falsifies the general, mistaken inference that Planck's statement of the second law of thermodynamics requires it to be impossible to construct an engine that produces work at the expense only of heat taken from the air or ocean. The experiment described in Yeh's paper demonstrates that when the air and the ocean are combined as a nonhomogeneous reservoir of uniform temperature, it is possible to construct an engine that produces work by extracting heat from the said reservoir. This does not constitute a violation of the second law of thermodynamics, but rather shows that the "reservoir" in Planck's statement may be in equilibrium or disequilibrium, and the statement holds only for the equilibrium case. Also, an entire reservoir can be in "overall" equilibrium, but in raging disequilibrium between various parts of itself. Classical thermodynamics only applies with the reservoir or part of it that is used by the system in its supersystem, when that part is in equilibrium.

We bring this out to show the analogy to our concept of the two additional components of the supersystem as the "reservoir" or external environment of the system itself.

We also point out that the concept of temperature itself is not strictly defined under disequilibrium conditions, as pointed out by Gabriel Laufer {410}.

The proof and a schematic diagram of a machine to do just such an energy extraction process at constant temperature in an environment in disequilibrium are shown by Yeh {408}.

#### 6.J.9 Latent Heat Work of the Correias

In addition to their glow discharge work previously discussed, Paulo and Alexandra Correa have demonstrated a method to optimize some anomalous form of energy from the sun, which transduces into heat, producing an anomalous  $T_0 - T$  difference registered in Orgone Accumulators<sup>178</sup> invented by W. Reich in 1939-1940. They have also

<sup>178</sup> **This** is Reich's terminology, not used in conventional physics. We suspect that **proper** application of quantum field theory with its four photon polarizations could

employed the optimized difference in this "latent" heat — their term — to drive a low  $dT$  Stirling engine of the MM6 type, to perform free work {41 1a-b}. The Correas employ their own new theory of the aether {412} to explain the effect.

Against the assertion that this is just normal solar energy warming, they have demonstrated the successful driving of the Stirling engine for several hours during nighttime {413}. With their latest improved version, they report speeds of the Stirling engine of 150 rpm during daytime (with  $dT$  values reaching  $22.5^\circ\text{C}$ ), and speeds of 30 to 80 rpm during nighttime (with  $dT$  values of  $3.1$  to  $9^\circ\text{C}$ ). There appears to be no obvious standard thermodynamic explanation or standard theory to explain how the anomalous heating occurs — although once it does occur, the explanation from then on is thermodynamically normal.

The Stirling energy is driven on a difference in temperature created between the top plate and bottom plate of a box by this anomalous energy. It is the production of the heat that is anomalous, not the driving of the engine. For comparison, imagine a bank of solar cells that would somehow operate at night, when no normal radiation from the sun was striking them. The Correa effect demonstrates such an anomaly.<sup>179</sup>

Dr. Eugene Mallove, an excellent scientist with impeccable credentials, has personally observed the Correa accumulator system driving the Stirling engine, and has examined it inside and out {414}. Though small, the heat and the motive power are real and the engine is really driven, in the absence of any kind of conventional batteries or other known power source.

be applied to transform the notion of "orgone" energy into specialized EM energy. We further suspect that orgone energy is really the transduction of the time-polarized photon energy into normal photon energy. We are assured by quantum field theory and the giant negentropy solution to the source charge problem that the instantaneous scalar potential involves this process.

<sup>179</sup> We point out that local regions of the sun may well produce Aharonov-Bohm effects, and probably do. Such reactions in the sun would localize some of the B-fields and emit curl-free magnetic vector potential radiation into space, striking the earth. Close examination and analysis of the possible reaction of uncurled A-potential radiation with the accumulator box and plates in the Correa process might yield a novel mechanism for the observed heating (scattering) effects, including the difference between daytime and nighttime levels, periodic variations, etc.

While the Correas utilize some of Reich's orgone and aether terminology, they are quite aware that the energy being converted is not normal transverse EM wave energy. Quoting {415}:

*"Aetherometry demonstrates that what traverses space is not transverse electromagnetic radiation (and certainly not sensible heat), but longitudinal electric ambipolar radiation emitted from the sun. All that electromagnetic radiation consists of is a local production of photons (for those who care to listen): aether energy is not composed of photons, actual or virtual. "*

We can generate sympathy for that statement, although we would still not rule out time-polarized (scalar) photons and longitudinal photons from quantum field theory, each of which is individually nonobservable, but when paired the two comprise an instantaneous scalar potential. As we previously discussed, the classical notion of the EM force fields  $E$  and  $B$  implicitly assumes interaction of the unseen causal "field-as-it-exists-in-massfree space" with charged mass having been accomplished, with the  $E$  and  $B$  being the 3-effect of this interaction after observation. Thus these force fields  $E$  and  $B$  are 3-effects (after interaction and after observation) rather than 4-causes prior to interaction and observation. We suspect that the Correas are trying to get at the causal 4-photon, rather than the usually assumed 3-photon. Further, a virtual photon spends much of its time existing as a dipole comprised of a virtual electron and a virtual positron. Therefore it spends much of its time in the presence of the giant negentropy 4-circulation, involving transduction of time energy into spatial energy and vice versa. It is this negentropy circulation represented by the virtual photon (or accompanying it, whichever one chooses) that the Correas are confronting as the "aether energy".

As previously discussed, an analysis of the Drude electrons in the electron gas of a detector builds a convincing case for EM waves in space existing in longitudinal EM waves, *if the spinning and longitudinally restrained electrons precess and act as gyros*. The detected transverse EM waves are in fact transverse precession waves of the gyro-electrons when perturbed by incoming longitudinal EM waves (longitudinal photons appearing in 3-space from the time-domain's scalar photon couplet). As Feynman put it {416},

*"We may think of  $E(x, y, z, t)$  and  $B(x, y, z, t)$  as giving the forces that would be experienced at the time  $t$  by a charge located at  $(x, y, z)$ , with the condition that placing the*



*charge there did not disturb the positions or motion of all the other charges responsible for the fields."*

The E and B force fields — and transverse photons — are not the form in which EM energy *causally* exists in 4-space prior to its interaction with charged mass. In that causal form, EM energy seems to exist in field-free form, as a direct curvature of spacetime — at least in Sachs's unified field approach. Further, this form may be represented as the causal precursor of longitudinal EM waves accompanied by time-polarized EM waves.

We will not repeat our past discussion of the great necessity to change the very notion of "propagation through 3-space", but that is the issue. In our opinion, the Correas have had to struggle with the use of this causal EM energy as it exists in 4-space prior to interaction with charge and prior to observation. Hence their view is solidly based that the photon does not exist until after the interaction — which in fact has much support once we remove the still-present assumption in classical electrodynamics that a material ether exists.

Our own recommendation is that this anomalous energy should be deeply investigated with the view that all EM energy in 3-space comes from the time-domain and the 3-space aspect is in terms of longitudinal photons, as we have proposed in our solution to the source charge problem previously cited. That is the only way that the nature of the EM wave in vacuum can be reconciled with quantum field theory's findings {19} and with Whittaker's decomposition of the scalar potential {85}, slightly corrected {12}.

Mallove also points out {417} that, if this aether energy view of the Correas has validity, it "*...suggests that physics is not just wrong, it is profoundly wrong — catastrophically wrong about even the most fundamental questions of existence, such as: 1) Is there an energetic aether? and 2) What is the nature of light?*"

We profoundly agree with Mallove's observation, and we believe we have explained the reason why physics is indeed profoundly wrong (widely substitutes effect for cause). Further, classical physics is decidedly wrong about the nature of light — from quantum field theory, experimental proof of superluminal communication, and action-at-a-distance effects.

In our view, the Correas presently have a replicable experiment that, once independently and thoroughly investigated, may force a deeper examination of the foundations of physics. Hopefully, the Correas'

experiment and others like it will finally force the separation of effect from cause, presently so mangled in physics and particularly in electrodynamics.

If the National Academy of Sciences and the National Science Foundation can be convinced of the horrible manglement of cause and effect in physics and especially in electrodynamics, perhaps they may yet wake from their long slumber and get the foundations corrected to eliminate such non sequiturs. If so, we shall have a magnificent new physics as a result.

If not, then the NAS and NSF will continue to profoundly reduce the security of this nation, since several nations have already made and weaponized such corrections to physics to produce what is called "energetics". Further, extraordinarily powerful energetics weapons have **already** been developed and deployed (and even employed), putting the U.S. at a strategic disadvantage because of the continuing reluctance of the NAS and NSF to correct the glaring and extraordinary errors in both physics and electrodynamics — and especially in electrical engineering.

Meanwhile, we believe that the work and experiments of Paulo and Alexandra Correa are at the forefront of capturing and transducing energy from the vacuum, in whatever form one chooses to consider the vacuum energy itself. They are also pointing the way to the corrections and changes necessary in the "old physics" if we are to better understand the world we live in.

### 6.3.10 Swiss Overunity Converter

**We** must also include the "Testatika" devices invented by Paul Baumann in a religious commune, Methernitha, adjacent to the village of Linden in Switzerland<sup>180</sup>. Figure 6-18 shows one of the machines, which over a period of 20 years were developed in various output sizes up to 30 kilowatts. Once started, the device is self-powering while also powering a very substantial external load (up to 25 kW). Many engineers and scientists have observed the machines in observation, examined them, and measured one or more in operation, so there is little doubt of their **authenticity**.

<sup>180</sup>The website for Methernitha is [www.methernitha.com](http://www.methernitha.com). One may read the statements of the religious group for oneself.

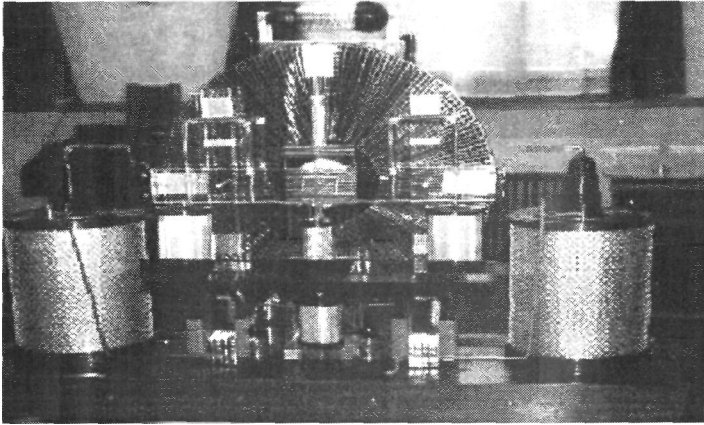

Figure 6-18 Swiss Methemitha machine.

However, there the science stops and mysticism and speculation begin. The religious commune releases no real details, except deliberately tantalizing clues. When questioned, the reply is that humankind in its present state cannot be trusted with such free energy. Almost all those examining the device have thought in ordinary electrical engineering terms, so very little comes from their examination because standard electrical engineering does not contain any theoretical explanation of  $COP > 1.0$  electrical power systems whatsoever. Baumann himself sometimes cryptically replied that his study of lightning discharges in nature gave him the operational principle. As we shall see, that may indeed be a very substantial clue as to the possible technical  $COP > 1.0$  mechanism, and one that does not exist in conventional classical electrodynamics.

The Methemitha (Baumann) machine resembles a Wimhurst machine with contra rotating static wheels, made of plastic or other insulating material with copper ribs and structures on one side and aluminum on the other. Use is made of the discharge into and from large capacitors and large coils. Also, at least one horseshoe-shaped permanent magnet assembly at the bottom is utilized. The major operating feature seems to be the contra rotating disks of a "Wimhurst" static generator machine, a magnetic field at right angles, and the sharp discharge of high voltage into and from large capacitors and large coils. The voluminous material on the Internet and in articles about the machines is mostly of little real use in contributing understanding or in proposing any legitimate mechanism.

We have not "solved" the machine's mechanism, since that would require close study of the device for a protracted time, and there has been no opportunity or time for that — although Baumann invited this author to come and see the machine some years before he died. Regrettably, I was unable to make the trip, and Baumann himself has now been dead for some years. We will therefore offer some technical suggestions pertaining to mechanisms that may be operating in the machine (or others like it).

First, we call attention to a paper by Aguirregabiria {418}. Quoting:

*"An ohmic ring that rotates with constant angular velocity in an external uniform magnetic field is considered as a simple model for a current generator. Under the assumption that all quantities vary slowly in time, the lowest-order approximation to the surface charge density is found. The flux of the Poynting vector through the loop surface is also computed. Unlike the examples that are given in textbooks, this flux is not always incoming: It has the outgoing direction around the loop parts where the electrons are moving against electrostatic forces. "*

In other words, contrary to textbooks, there are positions where such a ring produces currents in one direction, and positions where it produces current in the other direction — *in fact moving against the voltage and E-field, and thus serving as a true negative resistor in those latter regions.* This may be a profound clue to the negative resistor operation of Baumann's machine.

This unexpected negative resistor effect is in theory usable to provide a true negative resistance. If there are transformers in the machine (and there are in some of them at least), then if a true negative resistor were used as an external shunt across the external circuit connected to the secondary of a transformer, the transformer could be operated as a true COP>1.0 device. The back-field connection from secondary to primary would be reduced by the fraction of the return current to the secondary that is shunted in parallel to that current "pumped" back up through the secondary.

This should be considered as an important possibility in the Baumann machine's operation.

Second, a charging and discharging capacitor involves not only energy flow in a direction perpendicular to the plates, but also an energy flow in a direction parallel to the plates {419}. Each of the rotating "plates" is actually a rotating capacitor of sorts, with a dielectric between two plates

of special construction and dissimilar metals. The dielectric and the plates thus involve a complex intermingling of the negative resistor effect, a positive resistor effect, magnetic energy flows (both in entropic and negentropic manner in various regions), etc.

Baumann once handed two dissimilar plates, with a dielectric between them, to an engineer who measured it and found a startling several hundred volts across the plates! To date, no one is known to have been able to reproduce that effect.<sup>181</sup> We suggest that, if the dielectric material is layered and photorefractive in nature, it may be related to the negative resistors built by Chung {420}. If so, the physical pressure of the plates against the layered dielectric may also be quite important. By varying this pressure, Chung and her team found that their device could be made to exhibit negative resistance, positive resistance, or zero resistance. This leads us to speculate that Baumann may have used a "stressed dielectric" capacitor as a device having a built-in negative resistance. In that case, build-up of such a surprisingly high voltage would indicate high stress locked into the negative resistance dielectric.

We also call attention to a paper by LaPointe {421}, which will be discussed later under inertial propulsion and antigravity. Essentially, true Dirac hole current in the adjacent vacuum/space can be generated by powerful electrical discharges, particularly from capacitors or coils. When the unaccounted Heaviside energy component is also considered as well as the Poynting component, LaPointe's despair at the difficulty of obtaining sufficiently large voltage gradient across a very tiny distance is dispelled.

<sup>181</sup> We are reminded, however, of the peculiar phenomenon that can occur in large power capacitors stored on a warehouse floor. If their leads are not shorted, the capacitors will build up a self-charge gradually, and this can become quite lethal. For that reason, such large capacitors when stored will have their leads shorted, to prevent this "free cumulative charge and energy" from appearing and posing a serious hazard. To our knowledge, there has been no complete scientific explanation advanced for this "self-charging" effect in large storage capacitors. Our own hypothesis is that it is probably an effect of unaccounted Heaviside nondiverged energy flow components associated with various field/charge interactions in the area and with ordinary Poynting EM energy flow in the area, including within the earth itself. Further, with respect to the surface of the earth there is an increase in potential with altitude. Hence from any point above the earth's surface and a point on the surface, there exists a dipolarity and a "Kron open path". The broken symmetry of that dipolarity means that within it a continuous 4-circulation of EM energy flow occurs as well as point-dipole polarization.

If this speculation holds, then in examining lightning strikes and their more bizarre phenomena, Baumann may well have hit upon the fact that such discharges also generate negative energy as well as positive energy, although it appears that the technical concept of negative energy was foreign to him, at least in such terms. In short, he could have been unknowingly charging his large capacitors by Dirac sea hole currents, somewhat similar to Bedini's process.<sup>182</sup> In that case, most of the "negative resistance" operation could be explained by Baumann's transduction of large bursts of negative energy into large bursts of positive charging energy and current in his capacitors.

Or, said another way in terms of Aguirregabiria's effect, Baumann may simply have been charging capacitors in that "negative resistance" Aguirregabiria region where the current does flow backwards against the voltage.

At least we have proposed some known though rare phenomena, which Bedini and my four colleagues and I have discovered in independent efforts. We strongly suggest that the Baumann device may unwittingly incorporate several of these mechanisms, but that neither Baumann nor the other members of Methernitha seem to have any technical notion of them.

With that, we leave it to the interested researcher to perform his or her independent Baumann-type system experiments and build-ups. Eventually, as is always true in science, the experiment must determine the truth of what is really happening. Given the successful experiment, then a model must be contrived or fitted that (i) explains the new effects produced, and (ii) complies with normal EM operation of normal  $COP < 1.0$  systems.

## 6.4 Some Magnetic Processes of Interest

There are some 200 or more magnetic effects in the literature, and only about half of them are well understood. Of the remaining half, some are

<sup>182</sup> Bedini and the present author have filed a patent application upon this exact **mechanism** and process, and typical embodiments for accomplishing it. Bedini discovered the effect and used it for two or more decades, and after some intense struggle with the problem I was able to find the exact technical mechanism, including literature justification. This becomes a system to close-loop a "unitary" **type** of  $COP > 1.0$  system, which is covered in the patent application also. A different **system** can be used to close-loop a non-unitary  $COP > 1.0$  system, and that method is contained in the second MEG-type patent application of my four colleagues and I who invented the motionless electromagnetic generator (MEG).

partially understood and some are not understood at all. The COP>1.0 researcher interested in magnetic systems would do well to study magnetic materials science {422a-422c}, known magnetic effects, and particularly those magnetic effects that are still anomalous such as in leading edge superconductivity research. The new area of *spintronics* {423}, e.g., is rapidly advancing and will have future impact on COP>1.0 magnetic systems. We do not further discuss spintronics in this book, but merely call this rapidly emerging area to the attention of the interested COP>1.0 researcher.<sup>183</sup>

Let us examine a very few magnetic effects of interest, as a sampling of what we are referring to.

#### 6.4.1 Self-Powered Magneto hydrodynamic Motors

Interesting self-powered magneto hydrodynamic motor work has been shown by Bednarek {424}. He shows a multi-branch rotor in a galvanic cell composed of sulphuric acid electrolyte with copper and zinc electrodes. The unit develops an emf of about 1 volt, with the rotor placed in a vertical magnetic field such as from a large rectangular permanent magnet, where the field of the magnet is a few teslas in strength. The electrolyte and the rotor revolve in opposite directions. To change the direction of revolution of the rotor, the magnetic field direction is reversed. A linear self-powered magneto hydrodynamic motor is also shown, and has a similar principle of operation.

The interesting point is that these motors work, but less efficiently, when a water solution of table salt is used as the electrolyte. With the worldwide availability of seawater, this becomes an interesting possibility of "renewable energy" application. We leave it to the reader to further investigate this proven experimental technology as desired and to determine its practicality.

#### 6.4.2 Multivalued Magnetic Potential

Conventional system designers work with conservative fields, as shown in Figure 6-19. Conservative fields arise from a single-valued potential — a potential that has only one value at each point in 3-space that it occupies. Consider a rolling ball of mass  $m$  on the "oval track" shown in Figure 6-19, starting from point A and rolling on the right side path. With the ball at

<sup>183</sup> For technical information, see (a) Michael Ziese and Martin J. Thornton, Eds., *Spin Electronics*, Springer-Verlag, 2001; (b) D. D. Awschalon, N. Samarth, and D. Loss, Eds., *Semiconductor Spintronics and Quantum Computation*, Springer-Verlag, 2001.

rest at point A, we give it a slight push to velocity  $V_i$  adding kinetic energy  $K_i = 1/2 m(V_i)^2$ . At point A, the ball has its maximum potential energy  $P_A$  due to gravity.

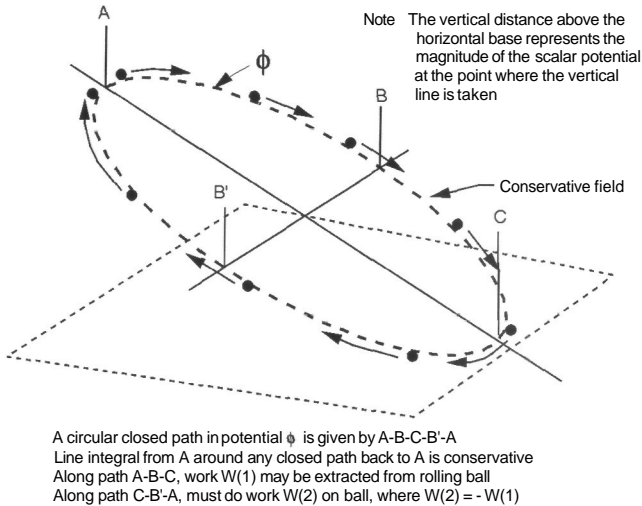

Figure 6-19 Conservative field use (single-valued potential).

As it moves to the right because of our push, the ball will accelerate due to the force of gravity and increase its kinetic energy until it reaches point C at the bottom, reaching its maximum linear velocity  $V_c$  and kinetic energy  $K_c$  at point C. Its change ( $P_A - P_c$ ) in potential energy at from point A to point C has been converted to kinetic energy [ $1/2 m(V_1)^2 + 1/2 mVg^2$ ] at point C.

Continuing on around on the left half of the path, as the ball rises toward A again, the portion  $(P_A - P_C) = 1/2 mVg^2$  —of the ball's kinetic energy at C that was added by the force of gravity from A to C — is returned to potential energy  $P_A$ . The ball reaches its lowest kinetic energy  $1/2 m(V_1)^2$  at A and also its lowest velocity  $V_1$ . For a perfect lossless system, once started in motion the ball would rotate around the track indefinitely, freely changing potential energy into kinetic energy and then back to potential energy. Nevertheless, it would not do any outside work, for that would represent losses or dissipations of energy from this conservative system. Consequently, the ball would quickly run down if work were being done, even if the system were otherwise "perfect".



If one integrates the change in potential energy around the track, the net change in potential energy is zero. The work done on the ball by increasing gravity to increase the ball's energy in one half-cycle, is taken back from the ball back when it climbs back out into decreasing gravity in the other half cycle. If one integrates the changes in kinetic energy around the track, once the initial velocity and kinetic energy are produced by outside forces in a perfect system, the net change in kinetic energy is zero. Of course, it is easily seen that the ball gains kinetic energy on its downward half of the track, and then returns the kinetic energy on its upward half of the track.

This situation is said to involve a *conservative fields* and the system will not produce any net energy to use as free work. Indeed, a real system will almost always have some friction and other losses around the path {425}, so the ball will gradually lose net initial energy given it, slow down, and eventually come to rest at point C, the lowest potential energy of the system.

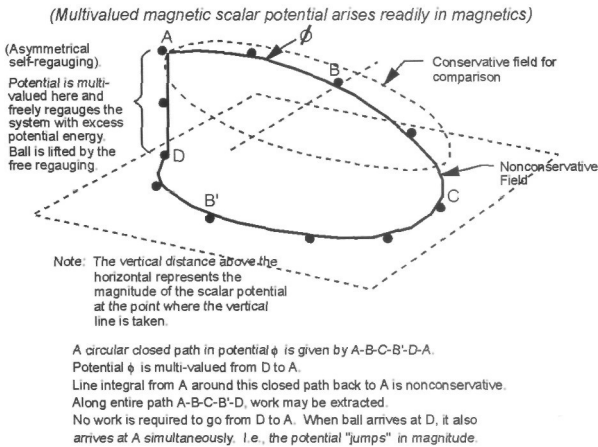

Figure 6-20 Field may be non-conservative for a multivalued potential.

A charge circulated through a closed current loop circuit also moves through a conservative field region in similar manner. Hence, there is no net excess energy input available for such a conventional circuit. It follows that one must arrange for inputting all the input energy (intercepted and collected by the circuit) that is then dissipated from the circuit's loads and losses. Unfortunately, half the collected circuit energy also goes to destroying the dipole, with less than half powering the load. Therefore, that circuit always exhibits  $COP < 1.0$ .

Now see Figure 6-20, where we provide an analogy using a rolling ball around a circular track, in a gravitational potential. In this case, the potential has a multiple magnitude A and D at point A-D, which is the same point (we plot a point in the potential's magnitude, not a point in 3-space, although there can be close approximation).

Approaching magnitude D from point B', the value of the potential is steadily reducing and is much lower prior to reaching A-D than it was when leaving magnitude A. During this phase, the ball is gaining kinetic energy from the gravitational potential, and can be used to perform useful work (up to all the energy gained, in a perfect system). Upon passing through point A-D, instantly the ball is again at point A on the right. We accent that the "instantaneous jump" on the diagram represents a free insertion of excess energy (asymmetric regauging energy) from outside the system. Rigorously that is a broken symmetry, which also breaks the internal energy conservation of the system. In short, the "ball" has been instantly "lifted" (in this simplified analogy) back to a higher potential by a free insertion of excess energy from the external environment. The main point is that a surge of potential energy into the "ball system" occurred, freely input by nature and the environment. The system can now go through the "doing work" routine again, traversing from A back to D and through it.

Note that this is a nonconservative system, because it continually receives a free and sudden input of excess energy from its environment. So this system — because of its broken symmetry — can continually do work and keep on going.

Indeed, so long as that free energy input from the environment occurs without fail, this is a "self-powering" system, completely complying with **the** laws of physics and thermodynamics. It violates the equilibrium thermodynamics because the system is periodically not in equilibrium with its environment. Consequently, the system can exhibit those five magic functions we spoke about previously. It can exhibit (i) self-organizing (in this case, freely getting that little ball from low potential energy D back to high potential energy A), (ii) self-oscillation or self-rotation (the ball will continue to go around and around the loop, even doing a little work in the process), (iii) output more energy than the operator inputs (in this case, the operator is not inputting any energy at all, so the energy output is indeed more than the operator furnishes), (iv) power itself and its load simultaneously (all the energy is being input from the external environment at the insertion of excess energy at point D to move the ball **back** to position A), and (v) exhibit negentropy.

This is an analogy to a nonconservative field and a multi-valued potential. In the case where a potential has discontinuous values at a single point, with the value depending upon whether the detecting charge (the "ball", so to speak) is to the left or to the right of that point, one has a *multivalued potential*. This multivalued potential actually represents a change of potential energy in the system, freely occurring without operator input. In short, it is an asymmetrical self-regauging, violating Lorentz's symmetrical regauging condition.

Actually, multivalued *magnetic* potentials arise naturally in magnetics theory, but —foolishly, in our view — theoreticians do all in their power to minimize or eliminate their consideration {426a-k}. They consider such a nonlinear change as being embarrassing and troublesome, and to be gotten rid of at all costs! However, if deliberately used and optimized, rather than eliminated, incorporating a multivalued magnetic potential can provide a *nonconservative magnetic field* (analogous to the illustration), where  $\int \mathbf{F} \cdot d\mathbf{s} \neq 0$  around a rotary permanent magnet loop. The multivalued potential represents a broken symmetry that further produces a nonconservative field.<sup>184</sup> In theory, such use of the multivalued potential and the resulting nonconservative field can enable a "self-powering" permanent magnet rotary engine, operating as a negative resistor freely extracting and using magnetic energy from the broken symmetry in the system's energetic exchange with the active vacuum.

However, note that the multivalued potential represents a point of sharp "self-regauging asymmetrically" by the circuit, with the regauging potential energy coming from the external environment. It requires that some external process in the exchange between environment and system must be automatically invoked at the multiple-value point, so that there is a sharp and sudden entry of excess potential energy received by the circulating ball (or by the circulating charges in an electrical circuit, or by the circulating flux in a magnetic circuit).

One such means of evoking such a sudden surge of excess energy at a point, momentarily, is given by Lenz's law, as discussed in the magnetic Wankel engine. Another means is by Johnson's sudden evocation of the

<sup>184</sup> In physics, the appearance of a force and its subsequent action to perform work is nature's way of restoring symmetry to a situation where symmetry has been violated. As can be seen, the net force can be used to translate something (such as current) and do work, thereby dissipating the excess potential energy received from the broken symmetry condition.

exchange force, which momentarily can produce a pulse of energy density even several hundred times as strong as the usual field energy at that point. For example, imagine that the ball in Figure 6-20 represents a magnetic rotor in a magnetic potential represented by the height of the ball above the dotted line base. The point (D-A) then represents the results of the system having suddenly injected an instantaneous exchange force at point D, to freely increase the potential and potential energy of the rotor system back to point A. The rotor is immediately lifted back at its starting potential energy situation at point A, freely, by this sudden and free evocation of the exchange force. We will briefly discuss the exchange force in our discussion of the Johnson engine.

### 6.4.3 Dromgoole Effect as an Example of a Novel Magnetic Effect

An example of a novel magnetic effect is the *Dromgoole effect* {427}. This is an interesting phenomenon where a voltage placed on a solenoid wrapped around a longitudinally magnetized iron wire may be increased up to 300 times in magnitude by twisting the wire through 90 degrees. If a scheme can be worked out whereby this dramatic increase in voltage potentializes and moves very substantial current, then perhaps the extra output can — at least momentarily — produce more output energy than the work required to twist the wire.<sup>185</sup> At least that could be a working hypothesis from which to launch experiments to see if it is possible.

The reason this may be possible is that any amount of energy  $W$  one wishes can in theory be collected from any finite potential intensity  $\phi$ , according to the simple equation  $W = \phi q$ , where  $q$  is the collecting charge exposed to and interacting with the potential intensity  $\phi$ . In the case of magnetics,  $q$  is analogous to the pole (magnetic charge), where the north pole is positive magnetic charge. The  $\phi$  then becomes the magnetostatic scalar potential.

So if we can produce  $\phi$  with only a little expenditure of energy, and then have that  $\phi$  potentialize a very large amount of charge  $q$ , we can collect upon the charge  $q$  much more energy than what we ourselves expended. The  $\phi$  produced is a change to the local vacuum potential, and hence the collection of energy  $W$  on charges  $q$  is actually a collection of EM energy from the local altered vacuum potential itself. Any potential we make

<sup>185</sup> The scheme must prevent *at least an appreciable fraction* of the spent electrons- from the external circuit and load — from being forcibly rammed back up through the coil against its back EMF. Otherwise the Lorentz symmetry condition **applies** and the arrangement will not produce COP>1.0.

becomes a change to the local vacuum potential, and hence a change to the local active vacuum. That does not seem to appear in electrical engineering, which model does not even incorporate modeling the active vacuum or its potential, much less a change to it.

While we discuss a few interesting magnetic effects in this paper, there are many more. The interested researcher is referred to such easier sources as Burke {428} and Cullity {429}. For more complex scientific sources and explanations, other publications are available {430a-430r}. In addition, it is helpful if the researcher is aware of some of the foundations problems in physics and electromagnetics {431a-431e}. Our point is that there are more than 200 known effects in magnetics, and only about half of them are well understood. For the other half, the understanding ranges from "partially understood" to "not understood at all." The latter half of the magnetic effects provides a rich ground for investigation by researchers seeking an asymmetrical self-regauging mechanism.

The COP>1.0 researcher must be prepared for an extended self-education period, and appreciable study and work. Some research discipline is highly recommended, such as starting one's own database and rigorously maintaining it up to date with one's latest interests. For the experimenter, a good lab notebook, meticulously kept and regularly posted, is an absolute necessity. Reading and searching the scientific literature is also highly recommended. It is not as simple as applying the principles one learned in university or technical school. Those techniques and principles are involved, but at some point in the circuit they must also be violated. Else COP>1.0 systems would long ago have been developed and marketed by sharp young students, graduate students, and post-doctoral scientists.

#### **6.4.4 Exchange Force and Johnson's Approach**

Refer again to our discussion of conservative versus nonconservative fields, above.

If one wishes to build a self-powering rotary permanent magnet motor, obviously one must evoke a condition whereby  $\int \mathbf{F} \cdot d\mathbf{l} \neq 0$  around a single full rotation of the rotor (and where  $\mathbf{F}$  is the instantaneous magnetic force between stator and rotor). For permanent magnets without any external switching, etc., that condition can only arise if an excess force is freely triggered by changes occurring freely in the magnetic materials themselves.

Fortunately, magnetic materials are almost always highly nonlinear, and so such self-triggering opportunities abound. They can occur because there are a multiplicity of mechanisms (dozens and dozens) going on

simultaneously in the materials of the magnets of both the rotor and the stator, and not just the standard polarity and field repulsion and attraction that electrical engineers use. These materials processes also involve direct and ongoing exchange of energy between the active vacuum and the local materials in the magnet.

**The** trick is to take one of these automatically ongoing processes that is already there and freely available but just not adroitly used, and deliberately evoke and enhance it to induce excess energy at the appropriate time, with a force in the appropriate direction. In simple terms, if you have eight more horses available to put into the harness to pull the load, and you only have two normal horses but wish to pull more load, then by all means you should hitch up and use at least one more additional horse, and take him from the six that are usually just standing by and not working at all. They may run back and forth a bit, while watching the others work, but that of itself contributes nothing.

One such additional force and free regauging mechanism always available is the exchange force, which can be checked in Feynman's three volumes of physics {433} and also in the reference by Cullity {429} previously cited. Good science dictionaries {432} also include helpful information. Reading the literature will add enormously to one' data base of effects and methods.

Howard Johnson's approach is to arrange highly nonlinear assemblies of geometrically asymmetrical magnets into complex configurations. At certain points in a magnetic field, these Johnson assemblies will trigger the sudden brief self-generation (actually a sudden release) of *exchange force* between stator and rotor. The exchange force is a known phenomenon {432, 433, 434}, though still not completely understood theoretically. It **can** be evoked asymmetrically by evoking electron-spin flipping, for example, which has led to the development of a new field of technology, **spintronics**. *Microscopically*, the exchange energy is much greater than the magnetic field energy, sometimes by a factor of  $10^3$  to  $10^4$  {435, 436}. *Macroscopically*, the resulting exchange energy can momentarily still be many times the magnitude of the ordinary magnetic field energy; e.g., by a factor of 200, which Johnson often achieves.

If **the** stimulated momentary exchange forces are oriented to always add to the thrust upon the rotor in the "powering rotation" direction, then the **multivalued** potential condition and  $\int \mathbf{F} \bullet d\mathbf{l} \neq 0$  are met. In that case, self-powering is permitted, if enough of these exchange force triggerings occur

so that the extra potential energy added to the rotor is sufficient to overcome the load and the losses being powered.

The self-triggering of each exchange force appearance produces an excess burst of force and energy<sup>186</sup> input into the system from its active supersystem environment. Thus, repeatedly the system is momentarily converted (in each exchange force burst) into an open system in disequilibrium in its energy exchange with its active environment, freely receiving excess energy from it. Because the exchange force "input energy burst" is short, multiple such "input bursts" must be used in a single rotation cycle so that the total energy input by all of them is significant.

In that case,  $COP > 1.0$  performance is permitted by the laws of physics, thermodynamics, and nature. Conservation of energy is not violated. Classical equilibrium thermodynamics with its infamous second law does not apply to the Johnson system, since the system is periodically an open system far from equilibrium and receiving excess energy from its active environmental exchange. *A priori* the Johnson system has increased its negentropy overall, and that negentropy (increased order or increased potential energy) can then be dissipated (disordered) to produce free shaft horsepower if the bursts of exchange force are properly coherent in direction and timing.

We diverge for a moment: As is well known, the equilibrium condition in a system is the condition of maximum entropy in the system; any disequilibrium condition reduces the entropy *a priori* because it is an excited state of the system containing additional potential energy. It is worth rigorously clarifying the infamous second law of thermodynamics. Quoting Lindsay and Margenau {437}:

*"[The]...statement of the second law: (a) the entropy... is a variable of state, (b) Its value, for a closed system, can never decrease."*

*... "Non-equilibrium conditions cannot be specified by variables of state, and their entropy cannot be computed. ...the condition of equilibrium is the condition of maximum entropy."*

<sup>186</sup> Technically speaking, the exchange force is not a magnetic field force, but a force that arises independently due to quantum mechanical considerations. Nonetheless, it is a real force arising in magnetic materials and affecting magnetic materials, as in permanent magnets.

In the first statement, the reader should note the assumption of a closed system in the first subparagraph, and the absolute requirement that the calculated entropy be a variable of state.

Also, the quotation can be falsified. Oddly, the "closed system" in classical thermodynamics is defined (illogically) as a system that does not exchange mass across its boundary, but may and often does exchange energy across it. We negate any absoluteness of that statement by Lindsay and Margenau by citing a counter example of a "closed" system with continuously increasing energy, fed by transfer of energy from the environment, and with no escape of the energy or very little escape of it. A specific example is a photon absorption by a mass particle. This system achieves increasing energy (order) as the process continues, hence achieves negentropy. This may be considered a fluctuation, of course, but it still places severe limitations on this law of thermodynamics and in fact negates any absoluteness of it. For such reasons, in this book we have redefined "closed system" as one that exchanges neither energy nor mass with its environment, and we recognize that there are no such systems in the universe. We have defined an "open system" as a system that exchanges either energy or mass or both across its boundary, so that we do not encounter the problem of the counter example cited. Further, general relativity requires an increase in the mass of any system that increases its potential energy, and a decrease in the mass of any system that decreases its potential energy. Hence energy exchange at all with the system, involves mass exchange since mass and energy are the same thing. The classical thermodynamic definition of a "closed system" has thus been falsified since 1915, with the definition becoming only an approximation rather than a generally valid definition.

In the second subparagraph of that first statement by Lindsay and Margenau, the reader should note that the closed-system assumption must be violated *a priori* if the entropy does decrease, and vice versa. If the system is broken into a set of subsystems, then the only way the entropy of the overall closed system to decrease is for one or more of the subsystems to be open (new definition!) and energy (order) to pass out of the system. Then an interesting thing emerges: For order (energy) to remain in the system as such, the subsystems taken as a whole must produce as much negentropy as they do entropy. Energy from an ordered subsystem can be emitted in disordered form, but then it has opened that subsystem and has entered the space between parts (subsystems) of the overall system. In other words, in a closed system, *any increase in entropy requires the subsystems to become open subsystems*. Again, the statement of this law of



thermodynamics eats itself. To stay in the overall system, this scattered energy *outside the subsystems* must then interact totally with another part of the system, and so on. This introduces disorder to the succeeding parts that interact. Therefore, the second law of thermodynamics itself *internally* violates its own "closed system" assumption because, to operate at all, the law requires continuing interaction between the active local vacuum environments and the subsystem components. In short, it requires a very special kind of overall or average equilibrium in an unavoidable energy exchange between the local vacuum and all the parts of the system. The source charge problem already demonstrates the universal violation of the second law and the thermodynamic definition of "open system", but both classical electrodynamics and classical thermodynamics have ignored this source charge problem for more than a century. Our solution to it was published in 2000.

Quite simply, there is no such thing as a truly closed system in the first place. Kondepudi and Prigogine come close to this statement in the following quotation<sup>187</sup>:

*'Anyway, equilibrium thermodynamics covers only a small fraction of our everyday experience. We now understand that we cannot describe Nature around us without an appeal to nonequilibrium situations. The biosphere is maintained in nonequilibrium through the flow of energy coming from the sun, and this flow is itself the result of the nonequilibrium situation of our present state in the universe.'*

In short, all systems on the planet — and we ourselves — are immersed in a nonequilibrium state a priori. Rigorously there is no such thing as an absolute equilibrium state on the planet, except as an approximation.

Now consider a perfectly insulated system, so that no heat can pass from the system outside it. An interesting constraint then exists on those "open subsystems" producing disorder (entropy). Unless equal reordering occurs in the subsystem-to-subsystem reactions, then disordering (heat) grows a priori. But this is not observed to happen in well-insulated systems approximating our theoretically perfect example! Otherwise, the temperature of a well-insulated system would increase until system rupture and failure. And experimentally that does not happen.

<sup>187</sup> Dilip Kondepudi and Ilya Prigogine, *Modern Thermodynamics: From Heat Engines to Dissipative Structures*, Wiley, 1998, p. xii.

It follows that, to maintain the internal equilibrium between subsystems and a constant internal temperature, a negentropic process is clandestinely involved. We submit that this process is revealed in our discovery of giant negentropy of the negative charge, and what may be said to be the giant entropy of the positive charge — i.e., in the discovery of the common "4-circulation" of energy surrounding a dipole from the time domain to the negative charge of a point dipole in 3-space (thereby entering 3-space once emitted by the negative charge), thence to the positive charge of the point dipole, and thence back to the time domain. For a single charge, the well-known vacuum polarization provides virtual charges of opposite sign, to convert the "isolated charge" into a set of composite dipoles, as previously explained.

The second law of classical thermodynamics, considered in a more modern light, appears to conceal hidden giant negentropy and hidden giant entropy, in the ongoing 4-circulation of EM energy in the supersystem. *It is not possible to eliminate the supersystem or the interchange between its parts; particle physics told us in 1957 that there is no equilibrium of any system without this ongoing exchange.* Any thermodynamics attempting to discard the supersystem exchange (which involved both mass and energy) is at best an approximation for special "reasonably well-behaved" situations.

If the entire system is not in net equilibrium with the external environment (i.e., if there exists disequilibrium between the separated parts of the supersystem), then classical thermodynamics does not *absolutely* apply to that system. The system is no longer *absolutely* describable by "variables of state".

Those objecting to  $COP > 1.0$  in an EM system on the grounds that it would violate the second law of thermodynamics (which already violates itself), would be well-advised to restudy the very notion of the second law and the thermodynamics definition of *open system*. Compare relativity's equating mass as energy. Then ponder the thermodynamics of open systems far from equilibrium with their active environment. Every system in the universe is open, and it has an ongoing exchange with its proven active environment (local active vacuum and curved spacetime). This exchange includes and exchange with every particle in the system. As pointed out by Lee:<sup>188</sup>

<sup>188</sup> T. D. Lee, *Symmetries, Asymmetries, and the World of Particles*, U. Wash. Press, Seattle, 1988, p. 46-47.

*"...symmetry implies conservation. Since our entire edifice of interactions is built on symmetry assumptions, there should be as a result a large number of conservation laws. The only trouble is that almost all of these conservation laws have been violated experimentally. "... "...this difficulty could be resolved by introducing a new element, the vacuum. Instead of saying that the symmetry of all matter is being violated, we suggest that all conservation laws must take both matter and vacuum into account. If we include matter together with vacuum, then an overall symmetry could be restored."*

The *system itself* is always in disequilibrium; only the supersystem can exhibit equilibrium. The second law of thermodynamics specifically does not and cannot apply to a system far from equilibrium, because of its implicit assumption of overall equilibrium without the active vacuum exchange. Also, a deeper balance is required between the hidden asymmetries existing between the subsystems and their local vacuum (and local spacetime curvature).

Indeed, *one cannot even calculate* the entropy for a system that — overall — is far from net equilibrium with its active environment. We quote Lindsay and Margenau even more strongly {438}:

*"Equilibrium states are the only ones that are capable of explicit analysis in thermodynamics..."*

And again {439}:

*"... variables of state have meaning only if they define an equilibrium state. Hence the quantity we are seeking will be meaningless unless it refers to equilibrium states."*

While we are at it, let us also address a serious flaw in the first law of thermodynamics. We again use Lindsay and Margenau for a succinct statement of the First Law {440}:

*"First law of thermodynamics. A complete statement of the first law comprises two assertions: (a) heat is a form of energy, (b) Energy is conserved."*

All that really says is that energy is conserved. It does not state that it is conserved in an object. It states that, whether the system is in equilibrium or not, energy is conserved. If heat is taken as disordered energy, then it

merely states that overall the energy is conserved, whether ordered or disordered with respect to some ordering criterion. It does not state that the disordering is conserved, and it does not state that disordering must increase or decrease. But *it does implicitly assume that all energy at some most basic level is ordered, else it cannot be energy (order)*. So it assumes that, at higher levels, energy can be disordered (incoherent). However, at the underlying basic level, it is and remains perfectly ordered — else it could not remain "energy and could not be conserved. As an EM example, in so-called "heat", *every scattered photon retains its perfect order; it is only the photon ensemble that is "disordered"*.

In short, each "basic piece" of energy is perfectly ordered, but the *ensemble* of the pieces may be disordered. Therefore, entropy applies only at a level higher than the basic energy quantum. Contrary to the assumptions of classical (macroscopic) thermodynamics, processes which directly engineer the basic energy quanta<sup>189</sup> — more exactly, the *action* quanta, consisting of *energy x time*, since energy cannot be "engineered" or changed in 3-space without also being engineered "in time" as well — are time-reversible. Hence they can be negentropic — simply because every observable system is "open" to, and in continuous energy exchange with, its active time environment (and also its active vacuum environment). Also, no system changes its spatial energy in any fashion, including ordering or disordering, without interacting with spacetime and spacetime curvature dynamics. It also changes its time-energy.

So in our view the notion of "disordering" and "disordering of energy" must be carefully reconsidered, as to exactly what is and is not being disordered, when the assumed "disordering" occurs, at what level it occurs, where and how the compensating reordering occurs, etc. We also point out that the simple discovery of giant negentropy {12} as the solution to the long-vexing source charge problem already removes the "absoluteness" of classical thermodynamics. Giant negentropy already violates the assumptions of classical thermodynamics at the elemental level in every physical system. Indeed, every charge in the universe already falsifies any "absoluteness" of the assumptions of classical thermodynamics.

This problem in the old classical thermodynamics has long been indirectly solved in particle physics, with the discovery of broken symmetry. As Lee states so clearly {441},

<sup>189</sup> Actually, energy is discretized, not quantized. Energy x time (i.e., *action*) is **quantized**.

*"As we expand our observation, we extend our concepts. Thus the simple symmetries that once seemed self-evident are no longer taken for granted. Out of studies of different kinds of interactions we are learning that symmetry in nature is some complex mixture of changing plus into minus, running time backward and turning things inside out."*

We point out that a symmetry involves a conservation law, such as are stated in classical thermodynamics, and a broken symmetry involves a broken conservation law. So the discovery of broken symmetry in physics was a profound change affecting all physics, including the staid old classical thermodynamics. Lee further points out the new complexity of concepts {442} such as symmetry (which is behind every conservation law, including the first law of thermodynamics):

*"At present, it appears that physical laws are not symmetrical with respect to C, P, T, CP, PT and C. Nevertheless, all indications are that the joint action of CPT (i. e., particle  $\leftrightarrow$  antiparticle, right  $\leftrightarrow$  left and past  $\leftrightarrow$  future) remains a good symmetry."*

So unless the first law is stated in terms of modern CPT symmetry, it does not absolutely apply! Further, every charge is changing time-energy into spatial energy or vice versa. Yet there is nothing about time-energy and its transduction into spatial energy, or vice versa, in the present textbook statements of the thermodynamics. The term "heat" does not refer to the presence of energy at all, but to the scattering (disordering) and escape of energy.<sup>190</sup>

Considering heat as "energy of the system", or "heat energy" of the system, is a grand non sequitur. Rigorously, "heat" refers to the reduction of higher levels of ordering of energy, and since the gist of energy is ordering, reduction of ordering is the very antithesis of energy! "Heat energy" thus is an oxymoron. Before the "escape", there is no "heat energy" (ugh!) in

<sup>190</sup> Think closely: We never take the temperature of a "system"! We take the temperature of the disordered energy (heat) leaving that system or its subsystems. We do measure the effect of the emitted disordered energy. But that has already left the system and is in the local vacuum (a second component of the supersystem). Thermodynamics might be usefully redone more exactly in terms of the supersystem. We leave that task to some budding young future thermodynamicists for a recommended doctoral thesis.

the system at all. The energy is present in the system *not as disordering, but as ordering, a priori*. If it were in the system, it would not have escaped nor would it be escaping from the system. More energetic molecular motion, e.g., is actually more energetic ordering, simply at an excited state (of greater energy!).

We stress again (and strongly advise the researcher to read) Romer's strong objection to the use of heat as a noun {443}, and we suggest that the entire subject of classical thermodynamics needs a thorough revision to tighten up its terminology, correct its definition of closed system, eliminate its conflict between the first and second laws, and remove its inappropriate consideration of heat as "energy". Otherwise, the presentation and general interpretation of thermodynamics itself will continue to be one of the great confusion factors one encounters in trying to think clearly about extracting EM energy from the active vacuum environment to produce and utilize COP> 1.0 systems.

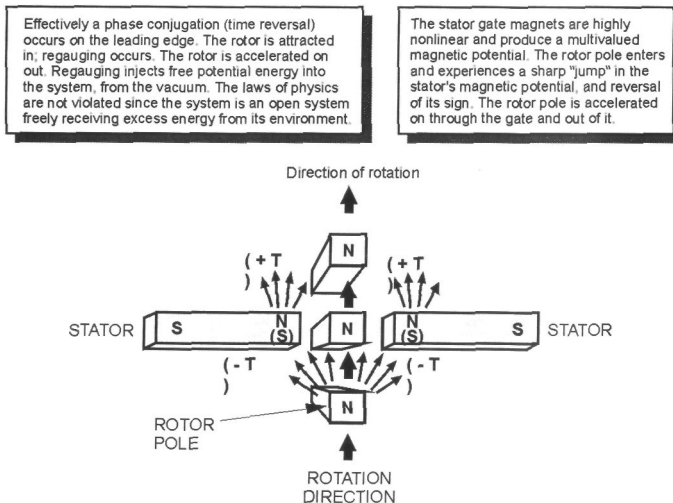
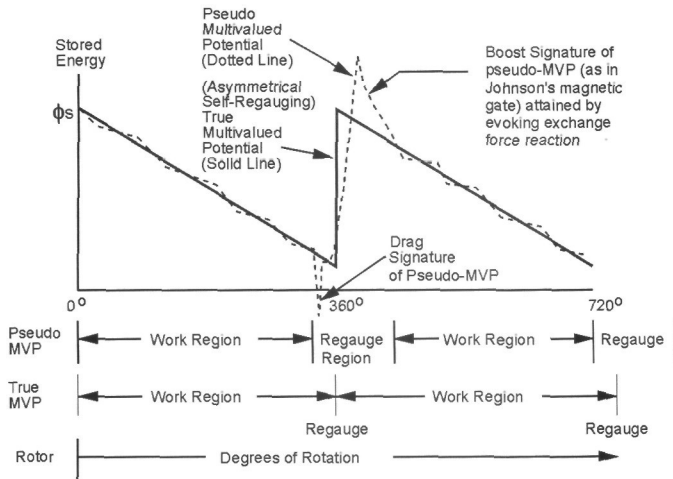

Figure 6-21 Concept of operation of Johnson's patented magnetic gate.

Johnson's approach produces a peculiar kind of multivalued potential. One **part** is conservative and of magnetic energy in nature, and the other part is nonmagnetic, being direct exchange force and energy effects on the **participating** atomic nuclei arising from quantum mechanical considerations. Nonetheless, the net *hybrid* potential can be multivalued at various points around the stator, and that is all that is required for broken

symmetry. If  $\int \mathbf{F} \cdot d\mathbf{l} \neq 0$  around a closed path, regardless of which set of forces  $\mathbf{F}$  represents, then that overall composite force field acting upon the rotor or object moving around the closed path is nonconservative. In that case, self-powering is permitted.

Figure 6-21 diagrammatically illustrates the operation of a nonconservative force-producing magnetic gate in Johnson's approach to a permanent magnet motor. As Johnson has shown, by using a multivalued hybrid potential (MVP) in his gates so that the resulting excess exchange force is properly oriented in direction and timing, a rotor magnet is attracted into a highly nonlinear stator gate region where the MVP is located. When it enters the MVP region where the exchange force is initiated, the rotor encounters a dramatic jump in the net potential with a change of polarity as the exchange force suddenly fires automatically. In turn, this produces a sudden accelerating tangential force in the region, usually against the prevailing magnetic force in the normal back mmf region!



Note Single regauging per notation shown Johnson uses multiple regaugings per rotation

Figure 6-22 Johnson's "refueling" a permanent magnet engine by asymmetrical self regauging. A multivalued potential is momentarily created by precisely evoking an exchange force reaction.

Johnson often confounds professors of electromagnetics by showing them that his special gate can produce attraction between like poles, with a north rotor pole being drawn into a north stator pole in that exchange force region. This can be understood by tracing the spin field flow patterns, but

cannot be understood by simple "like poles repel and unlike poles attract". In short, Johnson knows he is adding a force completely different from the magnetic force the professors have in mind as the sole acting force. It is rather like pushing two like poles of two little magnets together. You can do it because an additional force — your mechanical force pushing them together — is acting and overcomes the normal repulsive force between the two poles.

The sudden exchange force burst produces a sudden accelerating tangential force in the normal deceleration (back mmf) region of the stator-rotor arrangement. In short, Johnson utilizes a deliberately evoked burst of exchange force to freely overcome most or much of the back mmf (back-drag) region. This in turn produces a net driving force around the rotor's complete rotation, because the overall field combination is nonconservative.

Rigorous force meter measurements taken at 0.01-second intervals prove that this occurs as the rotor enters and passes through Johnson's gate. The results of one such experiment are given in Figure 6-22.

Johnson thus uses highly nonlinear magnet assemblies of novel design to create a special kind of multivalued potential in his magnetic gate by adroitly evoking exchange forces — *extra quantum mechanical forces* in addition to the usual magnetic field forces. The MVP produces a sudden extra rotational force, backwards to the back-drag (back mmf) region of the stator-rotor magnet arrangement where the rotor magnet assembly is entering and passing through the conventionally repelling like-polarity situation. The result is that a net north rotor pole is seemingly attracted in<sup>191</sup> to the otherwise repelling stator north pole region, then accelerated out the other side by the normal magnetic repulsion.<sup>192</sup> Net drive force results, instead of a net zero force. Engineer Ken Moore, a close colleague of the present author, independently tested a Johnson gate and verified the net driving force effect {444} within the limits of our little laboratory.

<sup>191</sup> In reality it is "forced in" against the repulsive magnetic force, by a superior force of a different nature, suddenly evoked.

<sup>192</sup> I.e., as the exchange force dies, the forces now acting are the normal repulsive magnetic forces, but the rotor has moved to a position where now this repelling force accelerates the rotor in the "load powering" rotational direction. In other words, the observer sees a like pole suddenly "attracted" into a like polarity region, move partially through it, and then suddenly be accelerated out the other side. But the "attracting in" force and the "accelerating out" force accelerate the rotor in the load-powering rotational direction.



Technically, Johnson's apparatus asymmetrically and suddenly regauges its exchange forces in such a manner as to momentarily overpower the back mmf region of the engine's rotation, thus producing a net multivalued potential and a net accelerating force around the overall rotation loop. However, correlated distant effects in magnetic materials are known. If distant compensation does occur, then the closed-loop capability might conceivably be defeated, if the total compensation is sufficient to provide an  $\int \mathbf{F} \cdot d\mathbf{l} = 0$  overall condition. Hence the research probably demands attention to maintaining both *local* asymmetry and *distant* asymmetry. If the distant correlation effects occur, only in that manner can an overall nonconservative field represented by  $\int \mathbf{F} \cdot d\mathbf{l} \neq 0$  be maintained around a completely closed magnetic loop.

This may be the problem with which Johnson appears to have been struggling for so long. He did solve the problem once, and produced a self-rotating permanent magnet motor that the present author personally tested over a period of about 2 hours. During a two-hour test period, the motor apparatus was allowed to self-rotate for up to 15 minutes at a time. Shortly after it became known that Johnson had successfully produced such a prototype, his laboratory was mysteriously broken into. The only thing taken was the magnet assemblies on that specific little successful demonstrator — in a laboratory with more than a hundred thousand dollars worth of magnets and magnetic assemblies of many kinds present.

As a personal aside, I have been associated with Johnson, off and on, for many years. He is a man of the highest integrity and an indefatigable researcher. It is my fervent hope that Johnson will succeed in his permanent magnet rotary motor project. All I can say as this goes to press, is that he is getting very close again, now that he has help and good machining accuracy, etc. for higher precision buildups. In the near future, I hope to be among the first to drink a good glass of champagne to celebrate his success.

#### **6.4.5 Radus Effect: Magnets with Preferred Flux Path Memory**

In the early NASA space program, magnetic boots for holding the astronaut to the skin of the space vehicle when outside it were required. A Westinghouse engineer named Raymond J. Radus had found that a permanent magnet applied to a dual flux path (Figure 6-23) would "remember" the flux path taken initially, until switched to the other flux path in an initial condition, after which it would remember that path as preferable {445a-445c}. A permanent magnet with such "memory" will split its flux in two parallel flux paths by some ratio, e.g., 20% in the non-preferred path and 80% in the preferred path. This preference can be

switched at will by proper manipulation. So Radus developed switchable magnetic astronaut boots for the space program, using his magnetic memory and flux path switching technique {446}.

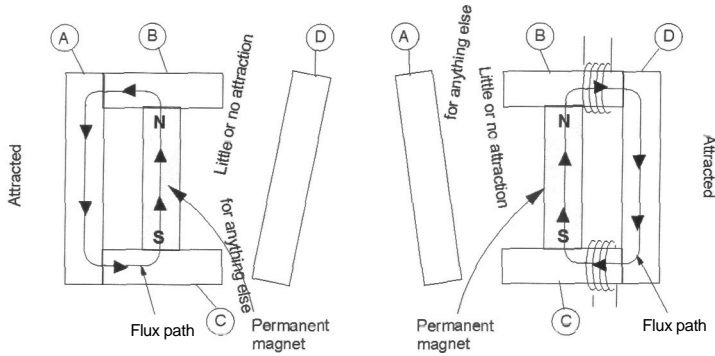

**Figure 6-23A.**  
Once the magnetic circuit is made, there is little attraction for anything else

**Figure 6-23B.**  
A single pulse through a coil can reverse the direction of the flux path

**Figure 6-23** One example of the Radus effect.

The Radus circuit differs from ordinary permanent magnet circuits in three ways: (i) It exerts strong magnetic force at one end while exerting hardly any at the other, (ii) the strong and weak magnetic poles can be switched end-for-end easily and at will, thus, in effect, turning the magnetism on and off at one given side of the circuit, and (iii) once switched, it remembers its direction of greatest magnetic pull indefinitely.

The original Radus boots were excellent. For the acceptance tests, an engineer clad as an astronaut walked across the bottom of a steel beam in a high bay research area, upside down against the pull of Earth's gravity (Figure 6-24). He *stepped as* he walked, putting his foot "down" and then picking it "up" {447}.

There is no problem in finding modern magnets strong enough to hold the astronaut firmly in such an upside position. The problem with simple magnetic boots using such strong magnets is that, once the foot is planted, the astronaut cannot pick up the foot again. Consequently, the best the astronaut can do with such magnetic boots is walk rather laboriously by "scooting" the foot forward, with the boot remaining in contact and the astronaut unable to pick it up.

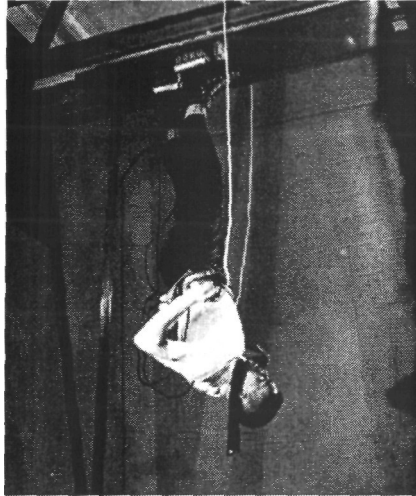

Engineer *walked* upside down on the underside of a steel beam in a high-bay area, wearing the RADIUS boots. He used a stepping movement, not shuffling.

**Figure 6-24** Acceptance test of the RADIUS astronaut boots.

The RADIUS boots completely solved that problem. The permanent magnet fields are switched away from the "boot sole contact with the beam" for that foot that the astronaut wishes to lift, so he can lift it easily and take another step. Then the fields are switched back in again so that the strong field is on the boot sole as he places his foot down. This switching of the fields allows him to walk in a manner resembling normal walking, though a little slower. To do that switching by normal "battery and electromagnet coils" would be prohibitively bulky and heavy — and awkward. With the RADIUS boots, the astronaut could walk in a manner very similar to slow but normal walking.

However, it is easily seen that an adaptation of the RADIUS process could conceivably be used to produce a self-switching, self-powered permanent magnet motor. Being a permanent dipole, a magnet is already a particular kind of "free energy generator", since it continuously extracts magnetic energy directly from the active vacuum due to its dipole asymmetry in the virtual photon flux of the vacuum.

The RADIUS boots were abandoned quickly. NASA then developed the present inferior "shuffler" kind of magnetic boots where the astronaut cannot lift his boot from the surface, but must "scoot" his feet along in a sliding and painfully awkward fashion {448}.

Even today, it is little known that in many virgin magnets fresh from the factory, their very first use conditions them with a Radus-type memory! *That fact can be used, e.g., to create magnets whose fields appear normal, but which deviate from the normal behavior of ordinary magnets, and which produce anomalies in their magnetic fields.*

The Kawai engine {31} uses a novel means of switching the flux path itself instead of overpowering the magnetic poles in an electromagnet. As this is written, Bedini has been notified that his patent with a "path-switching" effect control method has been accepted and will be issued. Although control of the Kawai engine was seized by the Yakuza, we expect to see that some of the first COP > 1.0 motors on the world market will be magnetic motors using the Radus effect or other flux path switching method.

#### 6.4.6 Hole Currents and Electron Currents

In a conducting solid, there are both hole currents and electron currents moving in response to a forcing electric field. In the simple case, electrons move in one direction along the conductor and lattice holes move (migrate) in the other. However, when additional fields are added, the situation can become very complex. The holes and electrons can move oppositely or together in the same direction, depending on the arrangement of the fields and voltages. One can even use fields at right angles to the conductor to affect the currents, and even stop them. This is a rich subject for the inventor, and one that does not appear to have been adequately explored for potential energy and power purposes. This is particularly true when the conductor material is bent or shaped, etc. This area is so broad that it will not be treated here; instead, we refer the reader to Burke {449} for a basic idea of some of the effects and current combinations that can be obtained. From there, an interested experimenter should search the materials science literature on electron and hole current responses of materials.

#### 6.4.7 The Magnetic Wankel Engine

For baseline comparison, Figure 6-25 shows a conventional linear magnetic motor. As can be seen, due to the difference between magnetic poles, a magnetic field exists along the line of the linear track, from the **end** having the magnets separated the least to the end having the magnets **separated** the most.

Figure 6-26 diagrammatically shows the scheme of operation of the magnetic Wankel engine. It is basically a linear magnetic motor, wrapped **into** almost but not quite a complete circle. A set of permanent magnets, **each** at an angle to the various radial lines of the device, comprises a

slightly widening spiral stator that forms most of a circle. A circular rotor with a sector magnet is mounted inside this spiral stator. An end gap exists in the stator as shown, so that the stator is not a completely closed ring. The direction of rotation of the rotor is clockwise as shown. For demonstration of the principle, the beginning air gap between rotor and stator is 0.1 mm and the ending air gap is 5 mm.

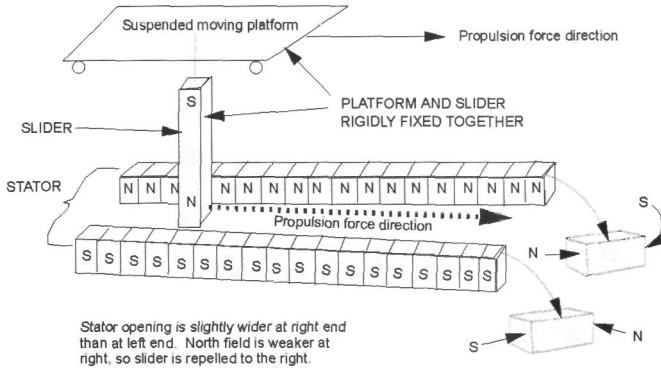

Figure 6-25 Type of conventional linear magnetic movement device

An electromagnet is mounted along the perimeter of an angular sector of the rotor, completing the stator gap. The electromagnet is weakly magnetized by a weak trickle current in the associated coil, furnished by a coil with a make-and-break magneto point gap. The electromagnet is magnetized, say, with the north pole facing radially outwards, and the south pole facing radially inside. In the stator, the permanent magnet north poles are facing radially inward toward the rotor, but at an angle, and the south poles are facing radially outward but at an angle.

Tangentially the north pole of the rotor is in a nonlinear magnetic field, and it will experience a clockwise force and acceleration from position 1 where the air gap between rotor and stator is the 0.1 mm minimum, to position 2 where the air gap reaches the 0.5 mm maximum.

If this were all that was involved, the engine would not produce COP > 1.0 because the tangential field is conservative unless additional *free* energy is introduced to overcome the back mmf region in the stator gap. When the rotor crossed the end gap in the stator between point 2 and point 1, very sharp and dynamic magnetic braking due to the back mmf would be done back upon the rotor magnet by the field of the stator magnets at position 1.

Since any real machine will have at least some friction and drag, the actual COP would be less than 1.0.

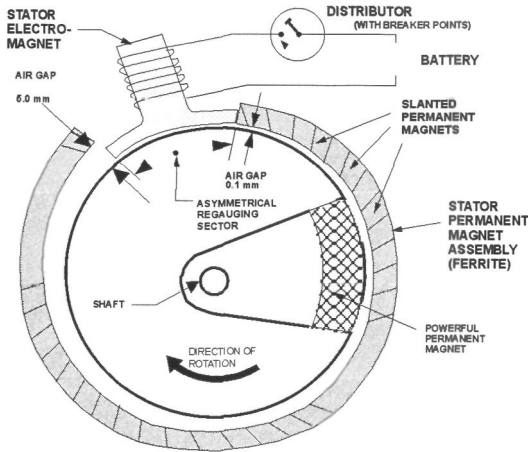

figure 6-26 Magnetic Wankel engine with asymmetrical regauging section.

Let us use the notion of the magnetostatic scalar potential (roughly, magnetic pole strength) to examine a new situation in the end gap.

Technically, let us regard a single unit north pole in the rotor, going from position 1 to position 2 (the acceleration cycle, where the engine will deliver shaft horsepower against a load), and going from position 2 to position 1 (where the magnetostatic scalar potential must be suddenly regauged asymmetrically to equal or exceed the potential at position 1, in order for the rotor to continue unabated or with even further acceleration. **That** is, when the rotor enters the "back mmf" end gap between position 2 **and** position 1, a sharp and sudden increase in the "stator magnetostatic scalar potential" must be accomplished, so that the potential in that region is equal to or greater than the potential at position 1. This effect, nearly freely obtained, is what is required for a self-powering magnetic Wankel engine.

In normal machines, conventionally this asymmetrical regauging part of the cycle is where the design engineer forcibly inputs energy from outside the system to do brute physical work on the rotor to forcibly "reset" the

machine, and to forcibly wrestle its potential energy storage back to initial conditions. In short, the operator himself arranges to furnish all the excess energy from outside the system that is required to brute force "regauge" the potential at that point, thus effectively creating a multivalued potential instead of a single valued potential. A multivalued potential achieved only by the operator himself furnishing the extra potential energy will not produce  $COP > 1.0$ . It will in fact produce  $\int \mathbf{F} \cdot d\mathbf{l} \neq 0$  of the motor section, but only at the expense of extra energy that the operator himself had to input and pay for. In that case and in a real system with some system losses, the net work out because of  $\int \mathbf{F} \cdot d\mathbf{l} \neq 0$  will still be less than the total energy input by the operator.

The forcible "reset" work is conventionally done by simply overpowering the field and reversing it (building it up equal and opposite in the other direction), but with energy totally input by the operator and not "free energy input from the environment" at all. The operator first pays to "kill" the existing field, and then pays to establish a field in the opposite direction.

To obtain  $COP > 1.0$  and self-powering, we must trick something else or some other process into furnishing that asymmetrical regauging energy — or most of it — for regauging of the magnetic Wankel engine in that stator gap zone. In other words, instead of engaging in the conventional wrestling match against the back mmf, we must let something else provide most of the energy for the wrestling.

During rotation of the stator from position 1 to position 2, we have been maintaining (and paying a little for) a tiny trickle current and small voltage from the battery into the coil around the electromagnet. As the rotor enters the stator gap, suddenly a sensor sharply breaks the distributor points, momentarily inducing a sudden powerful voltage in the coil. With a very short delay, a very sharp surge of current appears in the coil, producing a sharp and suddenly increased magnetostatic scalar potential (pole) in the gap region. That is the "multivalued potential" effect, where we pay a little to achieve it suddenly at that point, by invoking Lenz's law.

The effect is that suddenly the rotor is raised to the same or greater magnetostatic potential as exists at position 1, and "almost freely though not quite". If equal, the rotor suddenly is in a region with no back mmf, hence it experiences no deceleration braking. If the sudden potential is greater than the potential at position one, the stator in this normally back mmf region now actually experiences a further acceleration (a forward mmf) in that region.

Note that no *radial* mechanical work can be done on either the electromagnetic pole piece (part of the stator) or on the rotor, since neither the stator nor the rotor can move *radially*. However, there momentarily exists a clockwise circumferential magnetic field on the rotor in the stator gap, due to the gradient between the sharply regauged pole piece magnetostatic potential and the potential at position 1.

So we pay a little energy continuously (tiny trickle current, sharply broken breaker points) to get much more energy density momentarily in that small back mmf gap region only. The former back mmf in the stator gap is sharply eliminated by the Lenz force and converted to forward mmf. The rotor experiences a continuous acceleration throughout a complete rotation, due to the judicious use of an artificially induced multivalued magnetostatic scalar potential.

If the average shaft power output during the complete rotation cycle is made greater than the average power input to the asymmetrical regauging circuit during that same rotation cycle, the engine will produce  $COP > 1.0$ . This type of engine is also easily close-looped, since the excess output is **not** electromagnetic energy but mechanical shaft rotation energy.<sup>193</sup> Hence the problem of the Dirac sea hole current (discussed in Chapter 9) is eliminated.

Such engines have been built and placed in an automobile to power it, in Japan {450}, though there is no information on the exact overall COP. The design was lighter and smaller than a gas engine of the same power, and it was a pygmy when compared to other electric engines of similar power. **The** prototype 45-hp unit weighed 155 pounds compared to 440 pounds for a comparable electric motor. The rotary engine was compact enough to fit inside a two-foot cube. The engine was in development by Kure Tekko, a sizable firm that supplies auto parts to Toyo Kogyo, the Mazda maker. To my knowledge, no hard data on the input electrical power utilized for the trickle current and current-breaker has been made available by the Japanese. The principles, however, are quite clear and easily analyzed.

**This** may be one of the Japanese  $COP > 1.0$  engines suppressed by the Yakuza.

<sup>193</sup> For example, a geared or belted arrangement can be used to drive a very small but efficient DC generator that replaces the battery. Many other efficient arrangements are possible.



The researcher might like to consider using a strategically-placed Wiegand wire sensor (discussed in the next section) as the free "generator" providing a pulse of electrical energy to the pulse-magnetizing coil in the stator gap region at the precisely appropriate time. If that or some other similar "self-furnished" pulse of sufficient power can be delivered to the pulse-magnetizing coil, then the system would self-initiate a multivalued magnetic potential in that gap region. In that case, the driving magnetic field around the loop need not be conservative, and self-rotation would be possible without violating any laws of nature or electrodynamics. At least a small toy demonstration model might be possible, simply to illustrate the principle. Presently we know of no one who has tried it.

#### 6.4.8 The Wiegand Effect

If a Permaloy® or other suitable magnetic wire is properly tensioned and worked by repeated torsion while under tension, the skin of the wire is work-hardened and caused to have different magnetic characteristics from that of the internal core. This type of wire is called a *Wiegand wire*, or *pulse wire*, or "self-nucleating magnetic wire" (SNMW™).

When the pulse-wire experiences a certain level of ambient magnetic field strength, it will automatically switch its magnetic state, very sharply, producing a sharp magnetic field pulse. The effect is generally called the *Wiegand effect*.

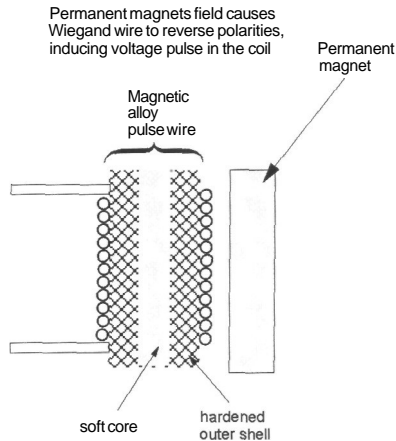

Figure 6-27 The Wiegand effect

If a coil of many turns of fine electrical conductor is wound around the Wiegand magnetic pulse wire, then when the wire suddenly alters its magnetic state, the sudden magnetic field pulse "cutting" the conductor bundle will produce a sharp electrical pulse. Thus the apparatus produces a sharp pulse of electrical energy, when the ambient magnetic field intensity reaches the pulse-initiation value. No input of outside energy is necessary. The apparatus simply gates the energy from the vacuum when it sharply changes its magnetic polarity.

Wiegand effect sensors may achieve voltage pulses up to a nominal 12 volts, in a typical application.

Numerous patents were issued to Wiegand prior to his death {451a-451h}.

Figure 6-27 diagrammatically shows the primary parts of a typical Wiegand sensor application, where the Wiegand wire is also known as a *pulse wire*. The operation of the pulse wire itself is shown in Figure 6-28. Figure 6-29 shows a typical rotary Wiegand effect pulse transmitter.

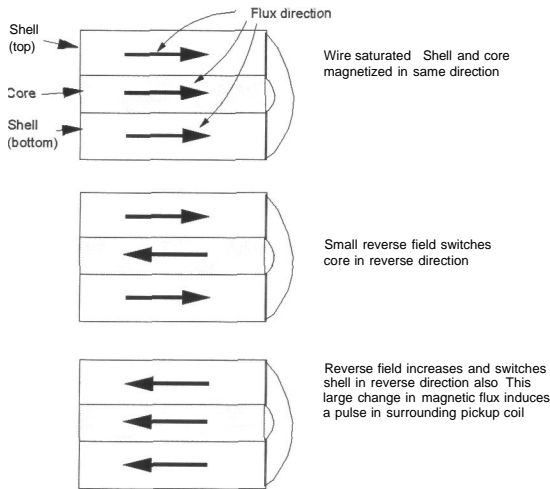
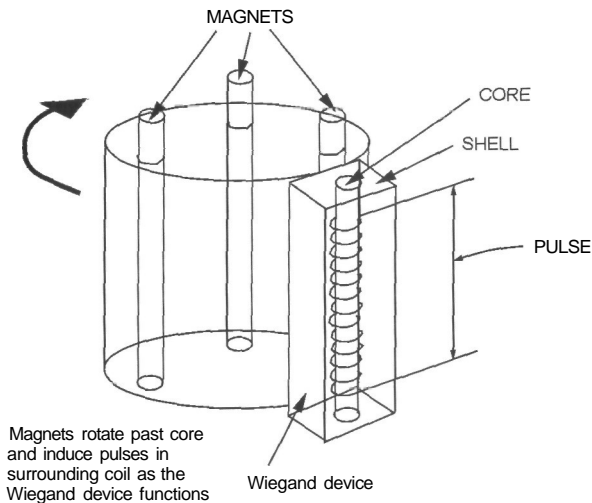

Figure 6-28 Operation of the Wiegand effect in a pulse wire.

Pulse wires find many modern "switching" uses, since one does not have to connect them to a power supply in order to obtain the electrical signal pulse generated in a magnetic field as it changes. The magnetic experience of **the** wires can be arranged (using a "resetting magnet") to automatically **reset** the pulse wire to its original condition after the initiation magnet has **fired** it. Many identification cards for personal access to restricted facilities

use these wires. Some magnetic memories use the effect. At least one European automobile firm has even used Wiegand wires to trigger the timing of automotive ignition systems.

The pulse characteristics created internally by the Wiegand wire represent a sharp, asymmetrical, self-regauging of the magnetics. The combined magnetic field consisting of the ambient magnetic field and the Wiegand wire magnetic pulse is momentarily a nonconservative magnetic field. It follows that a closed-loop integration  $\int \mathbf{F} \cdot d\mathbf{l}$  around some paths in the combined magnetic field of the system do not sum to zero.



**Figure 6-29** Operation of the rotary Wiegand pulse generator

In theory, at least, it should be possible to utilize something like the magnetic Wankel engine together with exactly self-triggering and self-resetting Wiegand units to form a self-powering permanent magnet motor. In short, referring to our discussion of the magnetic Wankel engine, it might be possible to use a special Wiegand sensor and pulse generator to furnish the properly timed pulse to the coil that enables the continuous operation of the Wankel engine. Obviously this type combination would have occurred to the Japanese scientists working on the magnetic Wankel engine.

We accent that the resulting system would be an open dissipative system, far from equilibrium in its energetic exchange with the vacuum during the Wiegand pulsing. The disequilibrium is achieved by the momentary self-regauging of the magnetic gap in the magnetic Wankel engine.

My colleagues and I have experimented with Wiegand wires and Wiegand sensors to a limited extent. The effect is quite real, fully documented in the scientific literature, and the wires and sensors are not too expensive. A typical coil of 1,000 turns on a 3-cm Wiegand wire will produce pulses of about 2 volts in a 1,000-ohm resistor. The pulse width (half maximum height) is about 20 microseconds. Essentially the Wiegand wires are immune to stray magnetic fields. Viewed on an oscilloscope, the pulses are very clean without spurious oscillations or hash. The field required to switch a typical Wiegand wire is typically about 150 Oersteds. The resetting field is quite a bit smaller, being about -20 Oersteds. With further work, it is probably possible to come up with Wiegand wires whose coils produce up to 20 Volts in a 1,000-ohm resistor. If 25 of these 20-volt Wiegand pulse generators wired in series could be induced to fire simultaneously across a 1,000-ohm resistor, something like a momentary half-watt device could be built. That might be enough to operate a very small version of the magnetic Wankel engine, etc. purely for demonstration purposes.

For practical power, of course, one would need to find a way to increase the power output in each Wiegand generator pulse. So far, no one has been able to successfully find a way to do it, at least to our knowledge. If the reader finds a way to do that, then the reader should certainly patent the process and use it in a self-powering magnetic Wankel engine!

So to those experimenters wishing to experiment with something relatively inexpensive, we would suggest investigating the possibility of incorporating Wiegand units into a magnetic Wankel-type small magnetic motor, and attempt to get a self-powering little unit, or try to build a self-powering version of the rotary Wiegand pulse generator. It is at least possible in theory, and if achieved in practice it will prove that self-powering EM engines are perfectly possible.

#### **6.4.9 Kawai Path-Switching Motor**

Japanese inventor Teruo Kawai has invented a process for adroit self-switching of the magnetic path in magnetic motors, rather than directly overpowering the magnetic field and then forcibly reversing it. The process reduces most of the back mmf in an otherwise rather conventionally switched magnetic motor, and results in producing a COP

that is approximately double the stated efficiency rating of the unmodified motor. Understand, the Kawai motor always has an efficiency less than 100%, even when its COP>1.0! Hence if one starts with a *high efficiency* magnetic motor — e.g., efficiency of 0.7 or 0.8 — one can obtain a modified motor having a COP of 1.4 to 1.6. Two Kawai-modified Hitachi high-efficiency magnetic motors were tested by Hitachi engineers, and the tests did indeed show COPs of 1.4 and 1.5, respectively, under rigorous and totally independent testing conditions.

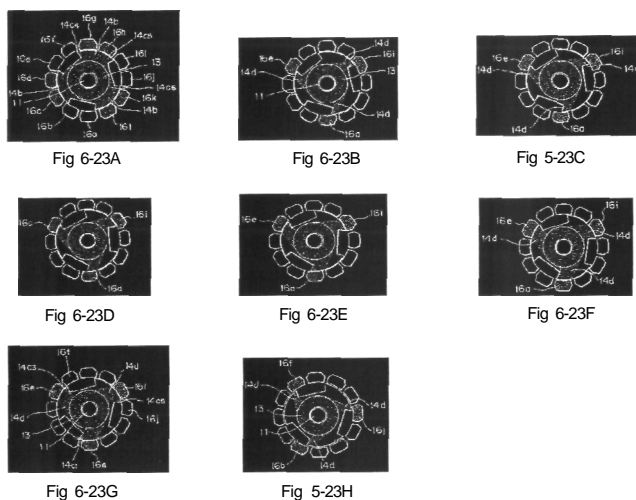

Figure 6-30 The Kawai path-switching process.

Figure 6-30 shows eight snapshots A, B, C, D, E, F, G, and H of the rotor advance of a typical Kawai engine, taken from Kawai's 1995 patent {452}. This is one end rotor/stator side of a two-rotor device, where a similar rotor/stator device is on the other end of the central shaft 11. In snapshot A, pole piece 14 had three outward teeth 14b dispersed equally around the circumference, alternated with three notches. An end magnet 13 provides the source of flux passing through the pole piece. With the electromagnets DC-energized, their core materials 16c, 16d, 16g, 16h, and 16k, 16l are shown shaded by flux from central magnet 13 out through teeth 14b.

In snapshot B, electromagnets 16a, 16e, and 16i are energized. The shaded area shows the sharp convergence 14d of the flux from magnet 13 through pole piece 14 and the edge of teeth 14d. Since the electromagnets are magnetized in attracting mode, the rotor will experience a torque tending

to widen the flux path from magnet *13* to the activated electromagnets. Thus a clockwise torque exists on the rotor, and it will start to rotate clockwise.<sup>193</sup> Note that each electromagnet is operating independently of the other two.

As shown in snapshots C, D, E, and F, the rotation of the rotor continues clockwise, widening the connecting flux path to the three activated electromagnets. During this time the torque on the rotor is clockwise.

In snapshot G, the flux path to the activated electromagnets is fully widened. In addition, the leading edges of the three teeth are just beginning to enter the domains of the next electromagnets *16j*, *16b* (see snapshot A) and *16f*. This is getting symmetrical to the original position shown in snapshot B.

Now the electromagnets *16i*, *16a*, and *16e* of snapshot G are deactivated, as shown in snapshot H, and electromagnets *16j*, *16b*, and *16f* are activated. This action asymmetrically self-regauges and resets the engine back to the original situation shown in snapshot B, but one more electromagnet beyond. The action cycle begins anew. As can be seen, in each complete rotation of the shaft, each of the three teeth of the rotor will be asymmetrically self-regauged multiple times. So multiple total asymmetrical self-regaugings, resettings, or "refuelings" are utilized per shaft rotation.

In each motor coil, at energization a tooth is just entering that coil, Energized in attractive mode with respect to the ring magnet around the shaft, the flux in the pole piece jumps from fully widened flux (and small or vanishingly radial torque on the rotor) to angled and narrowed flux (with full radial clockwise torque on the rotor). This is an asymmetrical self-regauging action. As previously explained, the narrowed flux and its angle exert a clockwise accelerating tangential component of force upon the rotor. By the asymmetrical self-regaugings of the engine, each coil is de-energized prior to beginning to exert radial back emf— which it would do if it remained energized as the trailing edge crossed it and again narrowed the flux path).

So the Kawai engine uses normal magnetic attraction to accelerate the **rotor** for a small distance, and then asymmetrically self-regauges to zero

<sup>193</sup>The Kawai patent contains a small error of misstatement. It states at first that the torque and rotation are counterclockwise, and then shows it moving correctly clockwise from figure to figure in the series.

attraction to eliminate the back-mmF drag portion of the attractive field. It regauges to zero as the reset condition.

For appreciable power and smoothness, the typical Kawai engine uses an extensive number of asymmetrical self-regaugings per axle rotation, for example 36 times on each end, or a total of 72 times for the two ends. The force field of each coil, accompanying its increased magnetostatic scalar potential, is oriented radially inward, so that radial work cannot be done by the coil on the rotor because the rotor does not translate radially. Advantage is taken of the initial clockwise acceleration force initially produced, and self-regauging eliminates the counterclockwise decelerating drag force that would be produced without the regauging.

The major benefits are that (a) multiple self-regaugings occur for a single rotation of the rotor assembly, enabling high weight-to-power ratio, (b) each electromagnet is energized only when positively contributing to the clockwise torque that drives the rotor, and (c) each coil is de-energized to asymmetrically self-regauge the system during those periods when the coil would otherwise create back-drag (counterclockwise torque) if it remained energized.

A conservative cycle is one in which the work done in the back-drag (mmf) region is equal to the work done in the forward boost (forward mmf) region. Self-eliminating the back-drag portion of the cycle is a form of asymmetrical self-regauging, and makes the net field highly nonconservative. The Kawai approach is thus permitted to attain  $COP > 1.0$ . In his U.S. patent, Kawai quotes performance measurements showing  $COP = 3.18$ . As we stated, Hitachi engineers measured two Kawai-modified Hitachi magnetic motors which exhibited  $COP = 1.4$  and  $1.6$  respectively.

Since the output is shaft horsepower, in principle the Kawai engine can be close-looped for self-powering, without consideration of the Dirac sea hole current. With its external close-looping system (not shown), it falls within the second close-looping class, that of an "outrigger" system. Only the unitary system closed-looping class requires consideration of hole currents in the Dirac Sea.

The Kawai process and several other Japanese overunity systems have been blocked from further development and marketing by the Japanese Yakuza. The present author and the Board of Directors of CTEC were physically present and in final negotiations (having reached agreement!) with Kawai to market his self-powering motors worldwide, when control

of the Kawai company and process were suddenly seized on the spot in our presence.<sup>195</sup>

#### 6.4.10 Bedini's Skin Depth Magnetic Switching

Bedini found a most interesting variation of flux path switching: he switches the direction of just a little fraction of the ongoing magnetic flux in a material flux path, on the skin of one side of it and with only a slight "skin depth".<sup>196</sup>

Suppose a flux path material is used as the stator pole of a permanent magnet motor. A large permanent magnet is used to magnetize that short length of flux path, as shown on the left in Figure 6-31, which illustrates a concept for a magnetic motor. For convenience, imagine that the small magnet on the right is not yet placed on the material flux path extension. The flux path extension is energized by the south north pole of the large permanent magnet on the left, and used as the stator in a rotary magnetic motor.

<sup>195</sup> To anyone who understands Japanese culture, Kawai paid me one of the greatest compliments possible. After his company representative called from Japan, Kawai shipped his *original proof of principle engine* — which first successfully demonstrated his flux-path switching process without being optimized for COP>1.0 — to me, here in the U.S. In the Japanese manner, he had entrusted me with his single most valued possession. From years of aikido experience, I fully understood the meaning of this unprecedented gesture, and expressed my deep appreciation accordingly. From our first meetings with Kawai and his group, I have and always shall have the utmost respect for Teruo Kawai. In my view, it is a sad loss to humankind to have his engine buried and withheld so brutally. Kawai had already achieved a closed-loop self-powering version, and it is this version upon which we reached agreement. In less than 24 hours after that agreement, the Kawai engine and company — and Kawai's own fate — were seized and no longer in Kawai's hands. For those unfamiliar with the deep spread of the Japanese Yakuza, the following are recommended: (a) Brian Bremner, "How the Mob burned the Banks: The Yakuza is at the center of the \$350 billion bad-loan scandal," *Business Week*, Jan. 29, 1996, p. 42-43, 46-47; Michael Hirsh and Hideko Takayama, "Big Bang or Bust?" *Newsweek*, Sept. 1, 1997, p. 44-45; Adam Johnston, *Yakuza: Past and Present*, downloaded from the Internet, Committee for a Safe Society, Organized Crime Page: Japan: History and present status of Japanese organized crime.

<sup>196</sup> Close colleague Ken Moore also independently discovered this effect in his own experiments, but then we found that Bedini had discovered it earlier. That was fine with Ken; he greatly admires Bedini and the marvelous discoveries Bedini has made. I greatly admire both of them, and am happy to call them best friends. After all, **science** has a human side as well as a materials side. Without one's close colleagues and best friends, science alone would be a miserable enterprise!



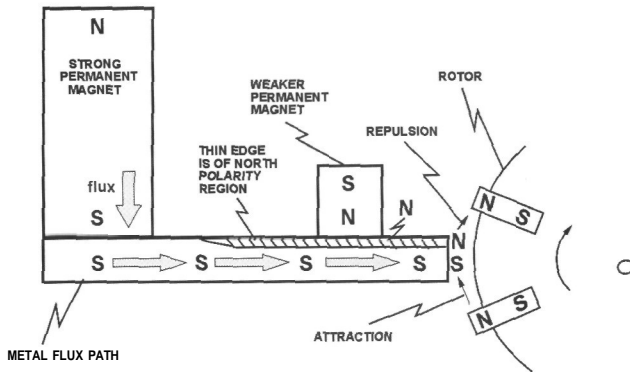

Figure 6-31 Bedini skin depth magnetic edge switching.

As can be seen, the north pole of the rotor, shown in the figure, is attracted to the resulting south pole of the stator. Power can be taken from the shaft of the rotor while it is being attracted in to the extended north pole of the stator flux extension. As it begins to pass the extension end, obviously if nothing else is done it will develop back mmf "drag" by being attracted back toward the north pole of the flux extension as it passes it.

However, suppose that —just when the rotor south pole is passing dead center of the stator north pole extension, one suddenly pulses a small flat coil placed on the face of the extension, which serves the function of the small permanent magnet shown on the right of the material flux path extension. Further, suppose the magnetic field produced by the coil is oriented as the field of the small permanent magnet, but is much weaker than the magnetic field of the large permanent magnet on the left. A very curious effect then occurs. This energized coil magnetizes the edge of the flux path extension, to a small "skin depth" as shown, with a *north* polarity. The magnetic flux is now bidirectional in that same material flux path extension.

Further, this edge-switching action is performed so that it is this "partial north polarity" of the now-altered extension that faces the rotor north pole as it begins to pass the extension and enters what previously would have been a back mmf section. Instead, now that former back mmf section is a weakened forward mmf region, *further accelerating the rotor*. This action breaks the Lorentz symmetry around the rotation path of the rotor, resulting in a net nonzero (nonconservative) magnetic field. Hence the entire rotor exhibits a net drive force around its loop. The rotor will

accelerate until the mechanical work performed upon the shaft, friction, etc. is equal to the net magnetic energy furnished to the rotor.

The beautiful part of this motor is that one does not have to "overcome" by brute force — and then reverse — the north polarity of the entire stator extension. In theory, the overall energy added to the rotor is greater than the energy that must be added for the "edge switching" of the magnetic flux path extension, because the entire back mmf of the motor has been eliminated and replaced by a weaker forward mmf. If the process of furnishing the "skin depth" weaker magnetic north field to the edge of the flux path extension is made sufficiently efficient, this engine also can be made self-powering, at least in theory.

The former "motor" design has been converted to a "motor/generator" design, by the addition of the edge-switching action. The novel factor is the use of bidirectional flows of magnetic flux in a single material flux path.

An additional improvement is to rig a Wiegand sensor and pulse generator or sensors in conjunction with the rotor action, to freely furnish and kill the edge-switching pulse to the face-magnetizing coil on the flux path extension, at the appropriate times. This is an area where even high school students will be able to experiment.

Bedini's patent on the edge switching process and its various embodiments and improvements has been issued {453}.

#### **6.4.11 Bedini's Flux Path Switching with Energy Capture**

One additional embodiment of the Bedini flux path switching motor is shown in Figure 6-32. Here the entire flux path is switched, by moving a small coil on the bottom side of the material flux path, as shown in the figure. As Radus showed {454}, it turns out that a much weaker magnetic field in that left bottom position will switch the flux path of a powerful permanent magnet field at the left top of the path, as shown.

Now, however, Bedini adds a transformer coil around the right end of the core (the right end of the extension is still the stator pole in the magnetic motor diagrammatically shown in Figure 6-32). When the flux path is switched back and forth, this transformer coil produces an AC signal output, which can power a load as shown, and can even be used to power the switching power supply. The trick is that it requires less energy to make the vertical flux path preferable to the horizontal flux path, than the energy delivered into the flux path by the permanent magnet. The potential for self-powering of a sufficiently efficient magnetic motor is obvious.

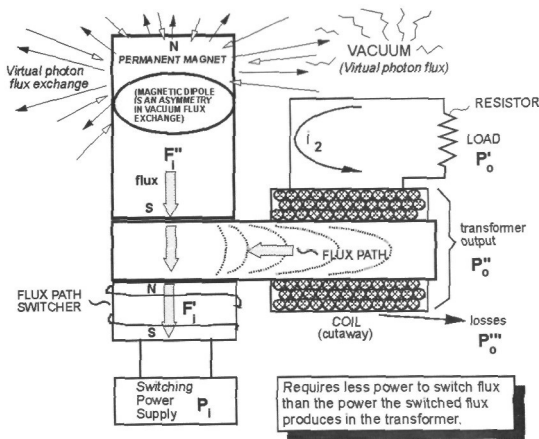

Figure 6-32 Bedini's total path switching and energy recovery process in a transformer.

So the motor can be powered while simultaneously acting as a partial generator. For efficient switching, this motor/generator can in theory develop  $COP > 1.0$  and can even be made close-looped and self-powering. We strongly accent that the primary excess energy input to the system is from the vacuum itself, via the broken symmetry of the large permanent magnet dipole at the left top of the material flux path. As we have repeatedly stated, the only energy problem is how to capture and utilize the EM energy freely received, transduced, and poured out from the vacuum by the source dipole's broken symmetry, without using half of it to destroy the source dipole.

#### 6.4.12 Transformer Secondary Shunted by a Negative Resistor.

See Figure 6-33. This embodiment assumes the availability of a true negative resistor — possibly an adaptation of a point contact transistor or other device. As shown in the figure, a transformer exhibiting  $COP > 1.0$  can be developed by adding a shunting *true* (not differential!) negative resistor across the terminals of the secondary, adjacent to the secondary. In this manner, the Lorentz symmetry of the closed unitary current loop containing the external loads and losses, and normally the secondary of the transformer in series, is broken.

Part of the return spent current is now "pumped" back up from ground side to power side of the transformer secondary without passing through the secondary. The pumping work is providing by dissipation (in the negative resistor) of energy freely obtained from the active vacuum environment. In short, one adds a negentropic process in parallel with the secondary coil, in

the secondary external circuit, breaking the otherwise enforced Lorentz symmetrical regauging of the discharge of the collected EM excitation energy in the secondary circuit. This provides the capability for a permissible  $COP > 1.0$  transformer.

ON EACH HALF CYCLE, ONE OF THE NEGATIVE RESISTORS SHUNTS PART OF THE RETURN CURRENT AROUND THE SECONDARY, FROM LOWSIDE TO HIGH SIDE, THUS DECREASING THE BACK-FIELD COUPLING FROM SECONDARY TO PRIMARY ACROSS THE TRANSFORMER. THIS LESSENS THE ENERGY DISSIPATION REQUIRED IN THE PRIMARY FOR A GIVEN ENERGY FLOW TRANSFER FROM PRIMARY TO SECONDARY

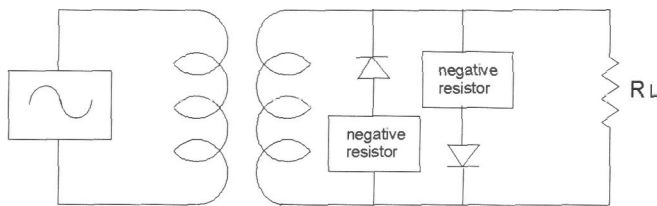

Figure 6-33 Transformer shunted by a negative resistor.

In theory, if the negative resistor can bypass all the current in the secondary, or almost all of it, the transformer can become a  $COP \gg 1.0$  device.

This overunity transformer can use step-up of the voltage from primary to secondary, and exhibits an asymmetry in its forward and backward field coupling between primary and secondary. Thus the dissipation of energy in the primary circuit need not be as great as the dissipation of energy in the secondary circuit. The *energy flows* are of course in perfect conservation, but there is no law of nature requiring the *energy dissipations* to be conservative between the primary and the secondary. It is strictly the backfield coupling from secondary to primary that enforces equal energy dissipation in the primary as in the secondary, in normal transformers. And that backfield coupling's strength is a function of the return current through the transformer secondary. By reducing that current, the back coupling to the primary is reduced, which in turn reduces the current draw of the primary from the external power supply.

No laws of physics, electrodynamics, or thermodynamics are violated by the asymmetrically coupled transformer power system with broken symmetry in its secondary to primary circuit couplings. In short, there is

less backfield coupling from primary to secondary than there is from secondary back to primary. The additional energy dissipated in the secondary circuit is freely extracted from the vacuum by the negative 4-resistor shunt.

Again, this application assumes the availability of a true negative resistor, to use as a shunt of the secondary.

The beauty of this application is that, once achieved, such a  $COP > 1.0$  transformer can easily be close-looped for self-powering by standard "governed" positive feedback. No concern as to hole current effects usually need be accounted for unless the COP becomes very large.

#### 6.4.13 Eddy Current Multiplier.

Figure 6-34 shows an example of an eddy current multiplier, adapted from Burke {455}. This is given as a somewhat unusual system which may exhibit novel effects and possibly can be adapted into a  $COP > 1.0$  system (e.g., by using permanent magnets instead of the coils and triggering things into unbalanced condition using a rotary pulse wire generator. We simply list it here as a candidate for the experimenter.

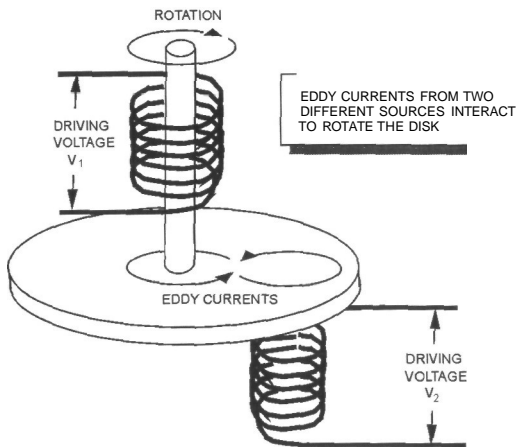

Figure 6-34 Eddy current multiplier.

In Figure 6-34, the shaft of the conducting disk is connected to a rotor, which could have arrangements for rotary type of Wiegand pulse generator of Figure 6-29 (with self-initiation and self-recovery) around it (not shown in Figure 6-29). One would start the rotating disk by hand. These Wiegand sensors would then automatically and repeatedly deliver a series of electric

pulses to the coils, momentarily generating the two eddy currents shown, so that dynamic force and rotary acceleration is obtained during the endurance of the pulses. In short, one would "electrically kick" the coils so that they continually deliver a propulsive "magnetic kick" to the conducting disk to repeatedly generate eddy currents to rotate it. The rotor is powered as shown by the interactions of the two unbalanced induced eddy currents. Such an arrangement could possibly exhibit  $COP > 1.0$ .

To experiment with such an apparatus, the major parts that must be developed are (i) the rotor and coils arrangement (the motor), (ii) the integrated rotary Wiegand effect pulse generator with self-recovery, and (iii) the proper timing arrangement. Each should be developed and optimized individually in the researcher's experiments, then combined and optimized together. This is an experimental area that can be cheaply investigated, e.g., by a college student or high school student for a science project. Whether  $COP > 1.0$  is achievable or not depends upon the efficiencies that can be obtained with the various processes involved. It is possible, at least in theory, for such an arrangement to be self-rotating once rotary motion is underway.

## 6.5 CONCLUSION

In this chapter we have advanced many approaches to  $COP > 1.0$  systems, that have been tried or considered by various inventors and researchers in the field. Many of these experimenters have attained concrete, replicable results, including results published in the hard literature.

We hope this sampling shows the reader that indeed we can have "self-powering" electrical power systems and  $COP > 1.0$  electrical power systems whenever the scientific community will come out of its preoccupation with the present seriously restricted electrodynamics and electrical power engineering practice and fund the necessary research. Simply funding a few graduate students for research and doctoral theses in these areas would be very useful and immensely more productive for electrical energy purposes than all the billions and years spent on chasing hot fusion.

Hopefully the iron dogma of the scientific community against  $COP > 1.0$  electrical power systems is slowly changing. If so, and if the community will turn loose those sharp young graduate students and post-doctoral scientists on the problem, very shortly there will no longer be an electrical energy problem on Earth, ever again. We strongly refer the reader to Deffeyes' book {456} to rigorously validate the coming increase of the price of oil, in the middle of the present decade. See particularly the

quotation from Deffeyes in our Endnote {342}. With the present extreme volatility of the MidEast and the continuing war on terrorism, the probability is high of eventual severe disruption of oil supplies and the energy infrastructure of the U.S.

An independent review of Deffeyes' book is given by Young {457} and we recommend that the reader digest that commentary also.

If the scientific community will fund the necessary research on permissible COP>1.0 Maxwellian systems, the quick results will solve the energy crisis, clean up the biosphere — including much cleaner air in our cities for the populace to breathe — provide cleaner streams, and result in far less polluted oceans. It will stop the pollution-caused destruction of species, and dramatically reduce the hydrocarbon combustion contributions to global warming. There will no longer be a necessity to consider "burying" in the bottom of the sea the excess CO<sub>2</sub> from massive hydrocarbon combustion to provide the much-needed electrical power, because it will no longer be necessary to burn the oil, coal, and gas to get the power. And there will no longer be any necessity for expensive and highly vulnerable nuclear power plants with their resulting nuclear wastes that will remain radioactive for thousands of years.

If cheap, clean EM energy from the vacuum is rapidly developed, we may *finally* get the scientific community's head wrenched back out of the big nuclear power business, as a colossal waste of research manpower and taxpayer dollars — as well as providing ticking time-bombs for the terrorist teams now already in the United States to attack and destroy. It is so easy for a person with appropriate technical knowledge to build a portable electromagnetic pulse (EMP) "shooter" that one shudders at the consequences of in-country terrorist teams that can do so. Try imagining what we would face when the electronic controls of one or more operating nuclear power plants are suddenly disabled and destroyed with the reactor on line and providing power. Chernobyl might look like a mild spring breeze in comparison, should we have one or more actual meltdowns.

It is not a pleasant consequence to contemplate, and that alone may eventually dictate the overwhelming urgency of achieving decentralized, vacuum-energy-powered electrical power systems as soon as humanly possible. The present centralized, cumbersome energy infrastructure is vulnerable beyond all sanity, considering the thousands of terrorists already in country, with weapons of mass destruction as well as more conventional sabotage means. As a single example, the former Soviet Union clandestinely brought in nuclear weapons into the U.S., and

Spetznaz teams to detonate them on order. Such weapons (and teams) are already in large U.S. cities and population centers. The reader is referred to Lunev's book,<sup>197</sup> for details about how the nuclear weapons were introduced.

After all, we do have to live and survive in the real world, and not just in an idealistic scientific environment. We are already at war, with alerts of potential danger to our nuclear power plants already having been given on several occasions. In the present very disorderly and very dangerous world we live in, many of the former options we have had for decades are rapidly ending. That includes the option for the leaders of the scientific community to continue "business as usual", if they wish this nation and their own families to survive. There is an old adage in war: *Whatever your determined enemy can do to hurt you desperately, he will do as his highest priority.* Sadly, in my opinion the leaders of the scientific community — unwittingly — are presently doing almost everything they can do to insure that the energy infrastructure goes, the national economy goes, a nuclear meltdown possibly occurs, and this nation and much of civilization perishes in a new dark ages.

<sup>197</sup> Stanislav Lunev (with Ira Winkler), *Through the Eyes of the Enemy*, Regnery, Washington, 1998. Lunev is the highest ranking GRU defector. He is a former Colonel in the GRU, the military counterpart of the KGB. On p. 22-33, he summarizes the Spetznaz capabilities. On p. 22-27, he summarizes Spetznaz use of nuclear weapons already on American soil. On p. 26, he gives some of the ways in which the Soviets easily brought nuclear weapons into the U.S. On p. 30 he confirms **Russian** seismic weapons. Use of EMP weapons is on p. 30-31. Use of very, very low frequency weapons to destroy the human brain, put people into a zombie-like state, and aid in brainwashing is confirmed on p. 31. The present war on terrorism has many more facets than are presented by the conventional news media.



Just as the dinosaurs were confronted with a new and dangerous threat, and failed to adapt, the electrical power infrastructure is now confronted with a potent threat against its very vitals and — so far — is completely failing to adapt. It is going to have to adapt or perish, which presently implies that we all perish along with it. Those who make it their nefarious business to see to it, will see to it.

So let us "see to it" first, scientifically, as rapidly as human research and development can do the job. The very existence of civilization may well depend upon it.

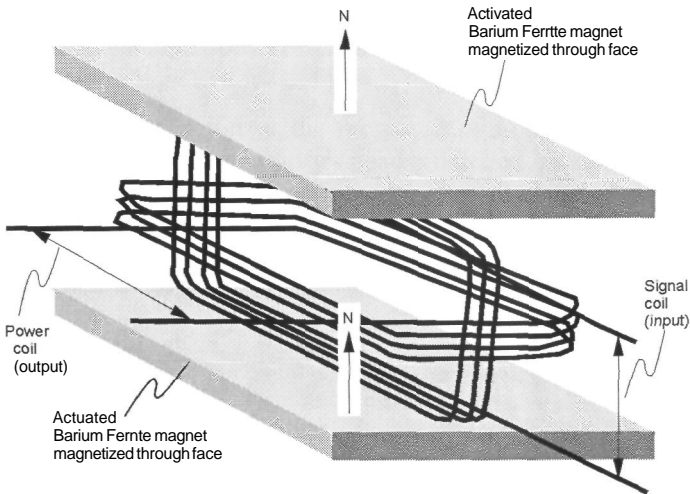

Figure 6-5 Sweet vacuum triode amplifier (VTA) construction.

## Chapter 7

# Aharonov-Bohm Effect, Geometric Phase, and the Motionless Electromagnetic Generator (MEG)

[Decision that hydrogen fuel is the future]. *"We are at the peak of the oil age but the beginning of the hydrogen age. Anything else is an interim solution. The transition will be very messy, and will take many technological paths ...but the future will be hydrogen fuel."* [Herman Kuipers, Royal Dutch Shell].

[Vacuum energy is real] *"...the acceptance of a structured vacuum described by an  $O(3)$  gauge group leads directly to the existence of novel charges and currents in the vacuum. These are conserved, or Noether, currents and charges and are clearly topological in origin. They spring from the fact that the vacuum is a topological space. Four such entities emerge: [1] A topological vacuum electric charge, also proposed empirically by Lehnert et al. [2] A topological vacuum electric current, also proposed empirically by Lehnert et al. [3] A topological vacuum magnetic charge, proposed also by Barrett and Harmuth. [4] A vacuum topological magnetic current, proposed also by Barrett and Harmuth.*

*Each of these four objects can provide energy, which can be loosely termed 'vacuum energy': energy coming from the topology of the vacuum.* " [Evans] {458}.

[Aharonov-Bohm effect] *"...the Aharonov-Bohm effect is a local gauge transformation of the true vacuum... [which] produces a vector potential from the true vacuum. [This gauge transformation] produces topological charge..., the electromagnetic field, which carries energy, and the vacuum charge current density first proposed by Lehnert ... and developed by Lehnert and Roy... ".* [Evans and Jeffers] {459}.

[Geometric phase] *"The concept of the geometric phase is closely related to the effect of a state function acquiring a non-zero phase factor after a quantum system undergoes a cyclic evolution. This means, that if a system after some time returns to its original state, the result of such an evolution will be recorded in the phase of the wavefunction. Moreover, this phase factor can be measured by interfering initial and final states. ... Although there are no widely recognized practical applications of the geometric phase, its experimental observations have been reported in many fields of science. The largest group of experiments have been carried out on polarized light ... and polarized neutrons ... The geometric phase has also been observed in magnetic resonance experiments ..., mesoscopic structures ... and molecular systems ... Analogues of GP — the Hannay angles — have been shown to exist in classical mechanical systems ..., the most famous example of which is the Foucault pendulum."* [Aleksiejunas]<sup>198</sup>

[Practical use of geometric phase]. *"The motionless electromagnetic generator is the first practical macroscopic use of the geometric phase."* [T. E. Bearden, 2001, to a correspondent].

[Impact of extracting energy from the vacuum] *"If they [quantum fluctuations of vacuum] can be [tapped], the impact upon our civilization will be incalculable. Oil, coal, nuclear, hydropower, would become obsolete — and so would many of our worries about environmental pollution."* *"Don't sell your oil shares yet — but don't be surprised if the world again witnesses the four stages of response to any new and revolutionary development: 1. It's crazy! 2. It may be possible — so what? 3. I said it was*

<sup>198</sup> I am much indebted to Dr. Rimvydas Aleksiejunas for this clear statement of the geometric phase. See his very elegant summary, "Introduction to The Geometric Phase Decomposition," on his Internet website at [http://signalogram.free-hosting.lt/Research/gp\\_dec.htm](http://signalogram.free-hosting.lt/Research/gp_dec.htm). His own publications in scientific journals and proceedings are also listed on the website, and many are available for downloading. His doctoral thesis dealt **with geometric phase** and he is a specialist in that field.

*a good idea all along. 4. I thought of it first."* [Arthur C. Clarke] {460}.

## 7.1 Introduction

In this chapter we give a history, some information, and comments about the Aharonov-Bohm effect {473}, which was generalized by the Berry phase {477} for adiabatic conditions, which itself was further generalized by Aharonov and Anandan {480} to remove the adiabatic limitation. The modern all-inclusive term is *geometric phase*, which has been found to be involved in a very wide variety of physics areas. In its embodiments, the motionless electromagnetic generator (MEG) does utilize the Aharonov-Bohm effect (geometric phase) in a unique manner that we explain. We also remark on what we hypothesize may be some related new aspects of the curl-free magnetic vector potential itself.

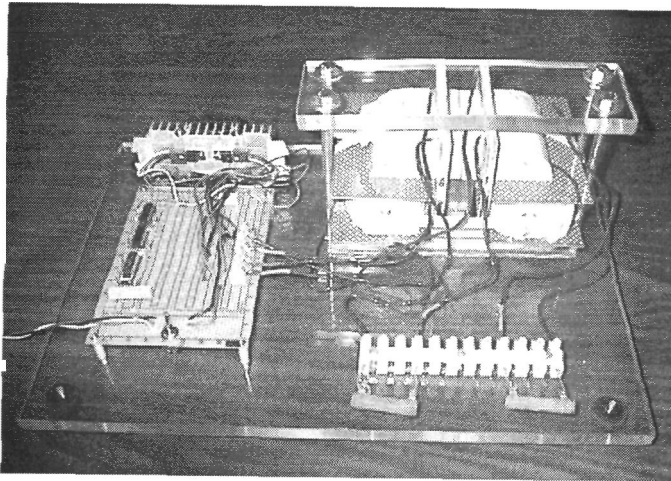

Figure 7-1 Motionless Electronic Generator (MEG)

**The** motionless electromagnetic generator (MEG) (Figure 7-1) was invented by Patrick, Bearden, Hayes, Moore, and Kenny {461} after years of research and experimentation. It has been technically described elsewhere {462}, and scientific explanations of the fundamental mechanism by which it successfully extracts useful EM energy from the active vacuum have been published in the recognized literature {463, 38a, 464}. Other closely related papers on extracting EM energy from the vacuum have been published or are submitted and in review {465a-465h}.

A version of the MEG has also been independently replicated by Naudin {466}, and in fact by others who did not wish to publish their results. By permission, Naudin's Mark II MEG replica is shown in Figure 7-2. Consequently, the MEG is a validated and replicated COP>1.0 system, as required by proper scientific methodology. Further, sufficient information has been released for any competent laboratory team to replicate a version of the MEG.

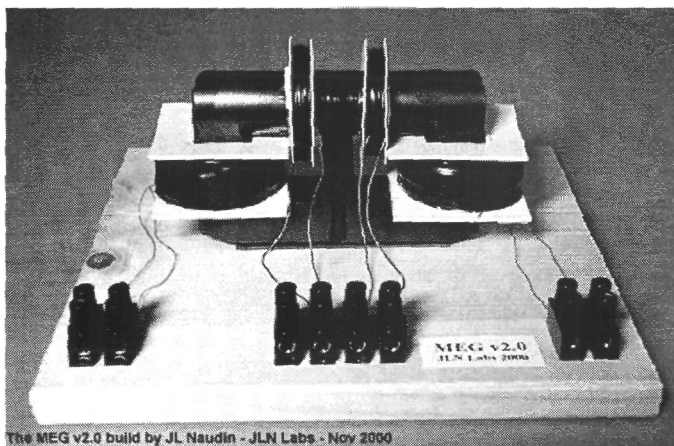

Figure 7 2 Nuadin's Mark II Replication of the MEG.

We give an overview of the MEG, the principles of its operation, the status of the project, and some indication of future plans.

#### 7.1.1 Status

As this is written, the first MEG patent has just issued {37}. A second Provisional Patent Application has been filed, and at this writing is in process of being replaced by a formal regular patent application. Two other patent applications are in preparation. All rights to the MEG are assigned to Magnetic Energy Ltd., Huntsville, Alabama, U.S.A., whose CEO is Dr. James L. Kenny.

In addition, Bedini and the present author have filed a provisional patent application on the process and embodiment for close-looping a COP>1.0 system for self-powering operation, and are in process of replacing it with a regular patent application also. Magnetic Energy Ltd. has permission to utilize the Bedini-Bearden close-looping process. In addition, Magnetic Energy Ltd. has its own proprietary close-looping process, for which a patent application is being prepared. The Company is also involved in

serious discussions with several large companies and financial groups for potential financing. When that funding is obtained, we will open a substantial research and development laboratory here in the United States, serving a separate production company to be set up with our financial partners to produce and market the MEG. Meanwhile, laboratory work to complete the research and development of the MEG is also ongoing under a cooperative arrangement with the National Materials Science Laboratory of the National Academy of Science of a friendly foreign nation formerly under the Soviet bloc.

### 7.1.2 Future Plans

Our plans are straightforward. We will continue to pursue and update our patents and file additional ones as additional discoveries are made. We will continue our negotiations with major financial parties until satisfactory and mutually beneficial capitalization is obtained (we expect that to occur before the end of 2002). At that time we will establish a modern Magnetic Energy Ltd. U.S. laboratory devoted to advanced research and development, as well as a separate production company in partnership with our funding partners. The final research necessary on the MEG (four areas of physics as well as the electrodynamics) will be completed in somewhat less than one year after setup of the lab and lab team, and the production company is expected to have the first engineering development production prototype at the end of that first year. We expect it to be a self-powering unit. We will simply put the first MEG units into production and on the world market immediately thereafter.

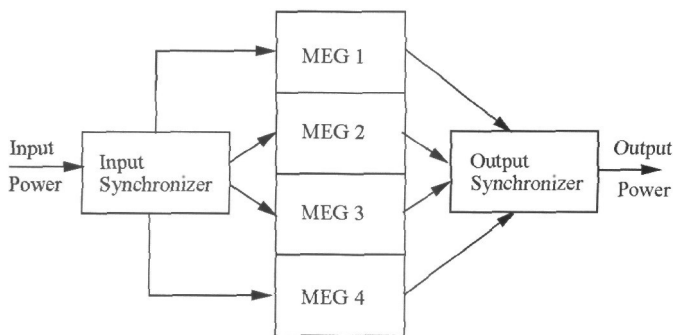

Figure 7-3 Block diagram of envisioned modular MEG design.

**See** Figure 7-3. The first production MEG is envisioned as a modular 2.5 KW unit together with a synchronizer unit simultaneously developed, so that up to six 2.5 KW MEG units can be synchronized in a power system

array. This will yield power units from 2.5 to 15 KW. We are struggling to have the closed-loop process completed and ready in that same first year, and if possible the very first MEG units will be close-looped and self-powered. At the end of the second year or before, we plan to have the close-looped basic MEG unit in 10 KW size, again with synchronizer so that up to six MEG units can be synchronized in an array. That will cover the 10 - 60 KW power system size, which is ideal for homes and small businesses. Once the units go on the world market, we believe that the market will be extraordinarily dynamic and productive. We intend to license multiple companies for production and competition for various markets, with no single company being given total monopoly worldwide.

## 7.2 Aharonov-Bohm (Geometric Phase) Effect

The Aharonov-Bohm (AB) {473} effect, or geometric phase (GP) {477, 480} effect, is now well known {467} in quantum mechanics and quantum electrodynamics, but does not exist in classical electrodynamics. The effect proves the reality of the potentials and their primacy over the fields. Further, it shows that electron effects can be generated by the magnetic vector potential  $A$  even in the absence of the magnetic field  $B$ .

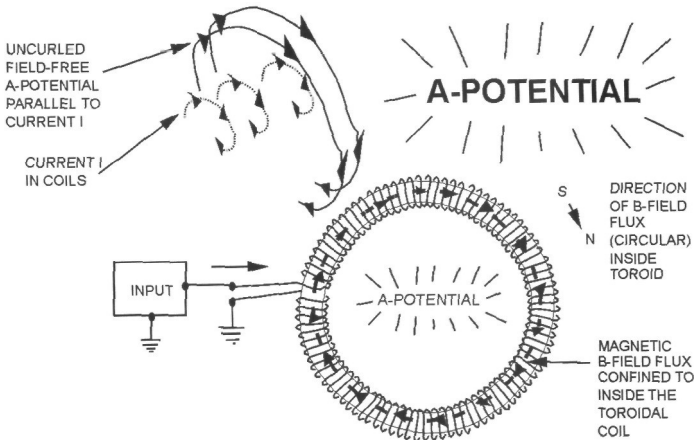

Figure 7-4 Aharonov Bohm effect for a tightly wound toroidal coil.

According to Feynman {468}, it required 25 years for quantum physicists to clearly face the issue eventually pointed out in 1959 by Aharonov and Bohm of the primacy and separate action of the force-field-free potential, in regions where no force fields were present (Figure 7-4) {469}. After the

effect was experimentally demonstrated by Chambers {474} in 1960, it then required another 25 years before physicists would accept it. Even today, another 16 years after full acceptance in 1986, to our knowledge the Aharonov-Bohm effect has not previously been utilized in any practical electrical power system {470}, much less one that has a  $COP > 1.0$ . As Aleksiejunas<sup>198</sup> states (see his quotation at the beginning of this chapter), there have not previously been any widely recognized practical applications of the geometric phase. Now there is a practical application of major worldwide importance, since the operation of the MEG depends upon the geometric phase (Aharonov-Bohm) effect to produce real electrical power from the active vacuum itself.

We also believe that the curl-free potential may not have been adequately investigated, particularly along the lines of its utilization in the MEG.

### 7.3 Abbreviated History of the Geometric Phase

The earliest work with a state function acquiring a non-zero phase factor after a quantum system undergoes a cyclic evolution was published in 1956 by Indian scientist Pancharatnam {471}. Pancharatnam noticed phase shifts of cyclic evolutions in optical phenomena. This means that, if the system leaves its original state and after some time returns to it, the result of the system's evolution will be recorded in the phase of its wavefunction. In addition, this phase factor can be measured by interfering the system's initial and final states.<sup>198</sup> Sadly, Pancharatnam's anticipation of the geometric phase factor did not receive the attention it so justly warranted, and his paper languished almost unnoticed for nearly four decades, when it was finally rediscovered. This was an excruciating scientific tragedy to Pancharatnam, comparable to that which befell Waterston {472}.

The effect of the field-free potential and the geometric phase issue were pointed out strongly by Aharonov and Bohm {473} in 1959 in a leading U.S. physics journal, causing much consternation in physics. Before that paper, most physicists still believed that all electromagnetic forces and effects were induced only by the force fields,<sup>199</sup> and not by the potentials.

<sup>199</sup> Indeed, the force fields do not even exist in mass-free space, but only in matter. Force is defined as  $F \equiv \partial/\partial t (mv)$  so that mass is a *component* of force. Feynman states: "...in dealing with force the tacit assumption is always made that the force is equal to zero unless some physical body is present... One of the most important characteristics of force is that it has a material origin..." "...the existence of the positive charge, in some sense, distorts, or creates a "condition" in space, so that when we put the negative charge in, it feels a force. This potentiality for producing a



In the prevailing belief, when the fields were zero there were no EM effects. Indeed, the potentials were largely regarded as mathematical conveniences.

Another point of consternation was that the A-potential is not uniquely determined, but is determined only up to a particular gauge transformation. So there can be two (or even more) magnetic vector potentials  $A$  and  $A'$  corresponding to a specific magnetic field. Aharonov and Bohm raised a disturbing question: How can two different "causal" A potentials produce the same effect? We will rigorously answer this question shortly.

While the experiments suggested were difficult, they were performed shortly after the publication of the Aharonov-Bohm paper. The very next year, in 1960, Chambers {474} experimentally demonstrated the Aharonov-Bohm effect, though not with complete decisiveness. A 1983 paper by Tonomura *et al.* {475} was significant, and a 1986 publication of further work of Tonomura *et al.* was decisive {476}.

In 1984, Berry generalized the Aharonov-Bohm effect into the geometric phase {477}. In 1985 the Tonomura effort plus experimental work by Webb *et al.* {478} settled the matter, as strongly stated by Schwarzschild the next year {479}. In 1987, Aharonov and Anandan {480} further generalized Berry's geometrical phase, freeing it from its adiabatic

*force is called an electric field.* " So Feynman was fully aware that not the force field but only the potential (i.e., the potentiality) for producing the force field exists in mass-free space. The electrodynamicists continue to be confused on that point. E.g., on p. 28 of his *Classical Electrodynamics*, 2nd edition, Wylie, 1975 Jackson states: "...the thing that eventually gets measured is a force..." , confirming that force is an observable and thus a  $d/dt$  operation imposed upon spacetime LLLT to give a purely spatial entity LLL. On p. 249, Jackson also states that "*Most classical electrodynamicists continue to adhere to the notion that the EM force field exists as such in the vacuum, but do admit that physically measurable quantities such as force somehow involve the product of charge and field.*" The two parts of the conventional assumption, as stated by Jackson, contradict each other. We point out that Jackson's book has been a standard of excellence for years, and no EM library is complete without it. It merely shows the extraordinary difficulty of rooting out the exasperating and mind-numbing confusion in physics between the observed effect and the unobserved cause. Force is an effect, after interaction (observation or measurement), hence cannot be the cause (which exists prior to interaction or measurement). Else, there is no difference between cause and effect, which destroys causality itself. This confusion is still there in even the hoary old classical mechanics, now some centuries old. By that standard, electrodynamicists have a long time remaining before they will have propagated this non sequitur" as long as the mechanical physicists have.

restriction and generalizing the geometry. Much discussion of the AB effect and Berry's geometric phase occurred {481a-481c}, but the scientific consensus was in: *The Aharonov-Bohm effect is real and the geometric phase is a widespread fact of nature.*

In 1985, Olariu and Popescu {482} published a very good overview and discussion of the AB effect up to that time, with hundreds of references.

Thousands of papers on the AB effect, the Berry phase, and the geometric phase have since appeared in the literature, and continue to appear at a rather steady and prolific rate. A few are listed for a sampling {483a-483k, 484a-484i}. The original Aharonov-Bohm effect has now expanded and spread widely through physics and into a myriad other effects and areas, such as the scalar AB effect, the Aharonov-Casher effect, magnetic vector potential vortices, quantum tunneling, chemical reactions, chaotic oscillation, and others. These related extensions are far beyond our interest here. We are, however, interested in what we hypothesize may be a new aspect of the perturbed curl-free magnetic vector potential  $A$ . We shall address that aspect briefly.

## 7.4 A Possible New Aspect of the Curl-Free Magnetic Vector Potential

We propose what may possibly be a unique new aspect of the curl-free  $A$ -potential — and thus of the Aharonov-Bohm effect — that has been uncovered in our MEG experiments. We caution, however, that this is a tentative interpretation and remains to be further validated.

First we state that the equation,  $\mathbf{B} = \nabla \times \mathbf{A}$ , usually accepted as the "definition" of the magnetic vector potential  $A$ , is not even a definition, because no equation is a definition.<sup>200</sup> If we rewrite the equation as the identity  $\mathbf{B} \equiv \nabla \times \mathbf{A}$ , then it is a proper definition — though not of the  $A$ -potential, but of the  $B$ -field itself, *given* that the  $A$ -potential exists and is primary. It also states that the  $B$ -field is simply a magnetic vector potential having swirl; i.e., the notion of the  $B$ -field captures that swirl aspect of a swirling  $A$ -potential. Hence the statement that  $B = \text{zero}$  implies only that **the**  $A$ -potential remaining is swirl-free and hence a linear EM energy

<sup>200</sup> No equation is a definition, *a priori*. It merely states the relationship of the total magnitude of the entities on the left to the total magnitude of the entities on the right. It does not define any entity on either the left or the right. One of the gross non-squeiturs in physics texts is to continue to present equations as "definitions".

current flow. Note that the  $B = 0$  condition does not specify the magnitude of the remaining A-potential, but *only* specifies that it has no curl. This is a rigorous answer to the original question posed by Aharonov and Bohm of how two different A-potentials can have the same magnetic field B (the same swirl). It is no more mysterious than two different rivers having a whirlpool of exactly the same swirl magnitude.

At least to first order, it appears we have arrived at a "semi-definition" of the A-potential along these lines:

*The magnetic vector potential A is an EM energy current in 4-space, which can be swirling or linear, or can have two components where one is swirling and the other is linear. The swirling component of the A-potential is also known as the B-field, and the linear component is known simply as the "curl-free A-potential". The A-potential exhibits a remarkable property: If its swirl component is localized and confined, the remaining space where the swirling A without localization would have been is filled by a remaining unswirling linear A-potential energy current. In short, by swirl-localization the swirling A-potential can be freely 'regauged' into two separated entities, with the sum of their energy being greater than the apparent energy of the previous swirling A-potential. Hence swirl-localization is a method of asymmetrical self-regauging of the A-potential itself with the excess energy coming directly from the active vacuum.*

If we take the view that any curled A is identically a B-field, then the "natural" A is not curled, because it requires a curl operation applied to it to produce a "curled A" or B-field. Therefore the "natural" magnetic vector potential A is simply a magnetic energy current in space, since it is a vector and has direction {458}. That is a *longitudinal EM energy flow process*?<sup>201</sup> We shall be very interested in the uncurled A-potential; i.e., in that linear energy current in space that is uncovered and freely produced

<sup>201</sup> Interestingly, around a toroidal localization zone, the uncurled A-potential does curve, but is only linearly following the curving current and the moving E-field from the moving charges in the current. In the MEG, the uncurled A-potential is even more complex, since we use each half of the toroid-like localization zone differently, with the B-flux going one direction (say, counterclockwise) in the left branch and the B-flux going in the other direction (say, clockwise) in the right branch, and with a crossover point in the middle.

when the B-field is localized. Indeed, we shall perturb it to make a large E-field, which we intercept and use to furnish emf to the secondary circuit and power loads.

Given a localized B-field so that we have an uncurled A-potential outside the localization region: If we now increase the magnitude of the A, that produces an increased linear energy flow rate outside the localization zone, in addition to increasing the B-field in the localization zone. If we decrease the magnitude of the A, that produces a decreased nonlocalized energy flow rate and a decreased localized B-field. In our view it follows that, when we oscillate the magnitude of the A-potential by any means whatsoever, we oscillate the nonlocalized linear EM energy current flow rate as well as the localized B-field. In fact, that creates a normal oscillation of the localized B-field, and also creates a nonlocalized *longitudinal wave* of electric field E by the equation  $\mathbf{E} = -\partial\mathbf{A}/\partial t$ , if the conditions localizing the curl operator — and hence localizing and holding separate the concomitant B-field produced by a changing E-field — continue in effect.

We have produced a mechanism for generating a nonlocalized longitudinal E-field wave without a nonlocalized B-field component being allowed to act outside a confined locality. We stress that a B-field component is produced, but remains localized in the special core material (that is one of the conditions required in the MEG).

We have also produced a mechanism for generating a nonlocalized longitudinal E-field wave with another very novel feature: the magnitude of the E-field and thus the magnitude of its energy density (its intensity) does not depend on the *magnitude of the input energy* used to perturb the A-potential, but only depends on how sharply we perturb it. Thus we have produced a mechanism for energy intensity amplification and magnification, freely. This is possible because the system is an open system far from equilibrium with the active vacuum, and specifically with the curl-free A-potential as an energy current at large in the local vacuum where it can be intercepted, collected, and used to power loads. The energy intercepted from the uncurled A-potential by the output section(s), is *additional* energy in excess of what is intercepted from the E-fields generated in core material B-field magnetic flux changes.

However, see our discussions of the giant negentropy process, earlier in this book. Any longitudinal EM "wave in 3-space" is accompanied by a longitudinal EM wave on the fourth Minkowski axis, in the time domain. EM energy does not observably propagate continuously in 3-space, since

observed propagation is a series of frozen iterative observation processes a priori). The "energy flow" actually consists of a propagation in 4-space of a *continual local circulation* of EM energy from the time domain (time-polarized EM energy) to each interacting point dipole in 3-space via the negative charge of the point dipole, thence to the positive charge of that point dipole, thence back to the time domain. In a time-reversed zone, the circulation is in the opposite manner. So what spreads as the "longitudinal EM energy current in 3-space" is actually the spreading point polarization of the vacuum and this giant negentropy 4-circulation involved in every point dipole of that polarization.

We believe this previously unsuspected process is involved in the Aharonov-Bohm effect (which is a sort of polarization in the time domain), other aspects of the geometric phase, fundamental polarization of the vacuum itself, and the very notion of "propagation of EM energy through space". At any rate, the hypothesis does fit the phenomena observed to happen in the MEG, so it warrants additional careful experimental investigation as well as attention from leading theorists.

Further, the MEG is practical and produces practical electrical power, but with a *purely electrical reaction* in the output secondary coils of the transformer section.<sup>202</sup> Hence there is finally a very practical use for the geometric phase: It extracts additional *nonlocalized* EM energy from the vacuum (and local curved spacetime) in addition to extracting and retaining *localized* energy. Both the extra "free" nonlocalized EM energy and the localized EM energy from the vacuum can be intercepted, collected, and utilized to power practical fuel-free MEG-type power systems.

We point out that the rate of changes of all E-fields produced in the secondary and primary coils also produce B-fields proportional to the time rate of change of those E-fields in each case. These secondary B-fields are

<sup>202</sup> This follows from the localization of all B-fields in the core material — including the B-field of the permanent magnet, those B-fields produced by  $dE/dt$  operations, and those B-fields produced inside the secondary coils, etc. All E-fields produced, however, including in the changing flux of the core and in the  $dA/dt$  operations of the external uncurled A-potential — are free from that localization restriction and can pass out of the core and interact with the output coils of the transformer section. In short, we have produced the world's first purely electric "induction-free" magnetic transformer device. The voltage and current, measured directly across the secondary coil's ends, is in phase within 2 degrees and even that 2 degrees can be eliminated. We expect the theorists to have a field day in modeling these new phenomena.

retained in the core rather than reaching out into surrounding space. Their rate of change then further produces E-fields, which pass out of the core and interact with the coils. Hence there are very novel "multiple feedforward and feedback" regenerative loops in the MEG's highly nonlinear operation, as well as chaotic oscillations.

## 7.5 Use of the Aharonov-Bohm Effect in the MEG

From the standpoint of electrical power systems, our own interest in the AB effect focused upon one important characteristic: the clear separation (and localization) of the B-field (the swirl component of the A-potential), leaving the remaining "natural" uncurled field-free A-potential as a free linear flow of energy current in the vacuum. This operation is iterative, and is produced by the core for every B-field produced in the transformer section. So a localized dynamic B-field makes nonlocalized dynamic E-fields, which themselves make further localized dynamic B-fields, which then further make nonlocalized dynamic E-fields, and so on. The result is a very extensive chain of feedforward and feedback field energy loops.

### 7.5.1 Separation of the Swirled and Linear A-Potentials

The AB effect has long been known in toroidal coils and in long solenoids. In a theoretically perfect toroid, for example, the AB effect separates and localizes the entire B-field inside the toroid, while the *curl-free* magnetic vector potential A appears in surrounding space outside the toroid. By our new interpretation and hypothesis, based on AIAS theoretical work published in the literature, this curl-free A-potential represents a nonlocalized longitudinal EM energy current in space.<sup>203,204</sup> Further, the curl-free A-potential is an extra flow of EM energy that can be intercepted, collected, and used while also still using the entire "normal" B-field energy localized in the core. The neat thing is that the E-field made from the

<sup>203</sup> This is addressed in M. W. Evans, T. E. Bearden, and A. Labounsky, "The Most General Form of the Vector Potential in Electrodynamics," *Found. Phys. Lett.*, 15(3), June 2002, p. 245-261. See also M. W. Evans et al., "The Aharonov-Bohm Effect as the Basis of Electromagnetic Energy Inherent in the Vacuum," *Found. Phys. Lett.* (in review).

<sup>204</sup> See also B. Lehnert and J. Scheffel, "On the Minimum Elementary Charge of an Extended Electromagnetic Theory," *Physica Scripta*, vol. 65, 2002, p. 200. In **extended** EM theory, the elementary charge may no longer be considered as a **fundamental** constant of nature, but is expressed in terms of the Planck constant and **the** velocity of light.

A-potential, and thus providing the actual intercepted and collected EM energy, can be made as large as desired, merely by manipulating the rise time and decay time of the pulses used to perturb the A-potential external to the core. Further, the same perturbation also perturbs the B-field flux in the core, giving rise to nonlocalized E-fields whose magnitude again depends upon the rise time and decay time of the perturbing pulses. Hence the  $dA/dt$  and the  $dB/dt$  become energy amplification causes, where all the excess F-field energy is furnished freely from the vacuum via a special kind of asymmetrical regauging and gauge freedom. In that sense, the MEG produces and applies a hitherto unrecognized form of direct field energy amplification by asymmetrical regauging.

We noted that this mechanism represents the formation of a locally curved spacetime<sup>205</sup> and engineering of the magnitude of the curvature itself. By freely increasing the local spacetime curvature, the appearance of additional EM energy density in the region follows *a priori*. That is, one still has all the B-field energy produced by the permanent magnet, but it is just confined to the space inside the core. All the energy one "pays for" or inputs with current and voltage to the input coil, in the normal sense, is the energy to *perturb* the localized B-field and the curl-free A-potential. However, even before perturbation to evoke energy amplification, there is already additional energy current that has appeared outside the core, where the magnetic field B would have normally extended. All the A-potential energy<sup>206</sup> is "extra" energy in addition to the normal B-field energy that

<sup>205</sup> More accurately there is one specific curvature of spacetime in the core of the MEG, representing the confined magnetic field B (the localized swirling A-potential), and there is another different curvature of spacetime outside the localization zone, filled with the nonlocalized curl-free (non-swirling) A-potential as a nonlocalized linear energy flow in space. Further, in the MEG we freely change and increase the magnitude of those spacetime curvatures, by the *rate of change* of the input energy rather than by its *magnitude*, and hence we easily increase the magnitude of the energy density of local space both inside and outside the core. That is the fundamental principle of the MEG's energy amplification (free regauging).

<sup>206</sup> Some scientists even deny that the curl-free magnetic vector potential has any energy! We answer that it produces energetic effects upon charged particles, hence must either contain energy itself or direct and gate the interaction of some local vacuum energy with those charges. In the MEG, the uncurled A-potential is oscillated, which does not appear to yield a *transverse* EM E-field wave at all. Instead, it appears to yield a *longitudinal* E-field wave with an associated scalar KM wave in the time domain. We also explained what appears to happen to the concomitant B-field wave produced by any changing E-field in the secondary

would otherwise have appeared out there but is now confined inside the core.

Further, the uncurled A-potential outside the core reduces its magnitude only inversely as the radial distance, whereas the normal B-field that would otherwise be there in the absence of localization would have reduced its magnitude inversely as the square of the radial distance. This far less rapid fall-off of the magnitude of the nonlocalized curl-free A-potential than the former nonlocalized magnetic field B can result in a remarkable increase in communications range — when a normal EM field antenna with oscillating EM field transmissions is compared to a curl-free A-potential antenna radiating the same power but as curl-free A-potential oscillating transmissions. Golden<sup>207</sup> has applied that effect for long-range communications.

With the application *of the free* Aharonov-Bohm effect produced by the core material and permanent magnet combination, rigorously there has appeared much more available EM energy from the local vacuum than the energy one inputs to the device as one's input energy "payment". Again, this is because the system is an open system far from equilibrium with the active vacuum processes such as the appearance of the uncurled A-potential and the iterative appearance of powerful extra B-fields and E-fields. The rise time and decay time of the input perturbation pulses produces an energy amplification effect both in the core and in space outside the core. When one utilizes this extra uncurled A-potential energy, as well as the now-confined B-field energy, as well as the extra B-fields and E-fields appearing from the iterative processes, then one can extract and use more energy than one himself "paid for" or input to perform the perturbation. Indeed, one can easily extract and use more energy from the curl-free A-potential alone, than one has input. By simply controlling the rise time and decay time of the input pulses, the magnitudes of the resulting E-fields formed in the uncurled A-potential (and in the perturbed trapped B-field perturbations inside the core) can be controlled at will.

(output) coils of the transformer section, etc. The core material withdraws and holds localized, all such magnetic fields formed in the internal MEG core processes.

<sup>207</sup> In the late 1970s Frank Golden demonstrated such an uncurled A-potential **antenna** which attained a range of 20 miles for a tiny CB radio, compared to a range of only 1 mile for the same CB radio with a normal EM field antenna. The energy density of the potential drops off inversely as the distance, while the energy density of the field drops off inversely as the *square* of the distance.



We also point out that all these amplified E-fields produced by multiple actions have both a conventional Poynting energy flow component and an unaccounted, much larger Heaviside energy flow component. Thus the total energy amplification factor can be very large (several orders of magnitude). With efficient interception and collection, in the future we expect to be able to produce at least 100 kilowatts of power out of the same size core and buildup now producing 80 watts or less in a highly nonoptimized set of laboratory experiment MEGs.

We again call the reader's attention to our previous discussions in this book, showing that all EM energy in EM circuits comes from the vacuum anyway (particle physics view) or from the time-axis (relativistic view). This has previously been hidden by the failure of classical electrodynamics to solve the source charge problem, which we also solved in this book after our paper {12} in 2000. Circuit theorists avoided it by indirectly assuming the source charges freely created from nothing all the EM energy in their fields and potentials. The use of the assumed fields and potentials and their Poynting energy was calculated, but never was the source of those fields, potentials, and their energy presented or accounted.

### 7.5.2 Using the Uncurled A-potential as a Linear Energy Current

A very simple equation allows utilizing the extra nonlocalized A-potential energy, even though it has no curl and therefore no magnetic B-field. That is  $\partial A/\partial t = -E$ . This equation means that, if one perturbs that large field-free A-potential outside the toroid, it produces an E-field, which we have argued must now be a longitudinal EM wave due to the perturbations *if the B-confining operation is still imposed*. By oscillating the A-potential perturbations, one produces an oscillating E-field that is also an oscillating longitudinal electric E-field wave without an accompanying B-field wave.

The oscillating B-fields in the core also produce E-fields proportional to  $\partial B/\partial t = -E$ . These extra E-fields are in phase with the E-fields produced by the perturbed external A-potentials, considering the wavelength of the frequencies at which the MEG is operating (30 to 80 kHz nominally).

Interestingly, the time-oscillating rate of change of the E-field in this longitudinal E-field wave does produce a magnetic B-field, but it is confined to only the core material and not in the nonlocalized external spatial region *because of the localization capability of the core material*. The core simply changes its permeability and holds the additional B-fields and their flux in there, thus forming additional uncurled A-potential outside the core. The E-fields produced by variations of the core B-field flux is not confined, but freely passes out of the core material

*If that B-field (curled A) is sharply localized by an ongoing localization capability, the longitudinal E-wave has its produced magnetic B-wave component stripped from it and localized. In that case, the process produces a purely longitudinal E-field wave outside the localization region — with the possible exception that a longitudinal B(3) field wave component pioneered by Evans {485} may be produced as well. That is left as an open question presently unresolved in our MEG experiments. We tentatively believe that the B(3) field wave component is in fact produced, but also forcibly localized in the core along with the magnetic field B. If so, its perturbations will also contribute to producing extra E-fields.*

See Figure 7-5. In the MEG, the localization is accomplished as a unique function performed freely by the special nanocrystalline layered core material. So contrary to the case of the solenoid or toroid, one does not have to "pay" any EM energy to the localizing component to obtain the localization function itself.

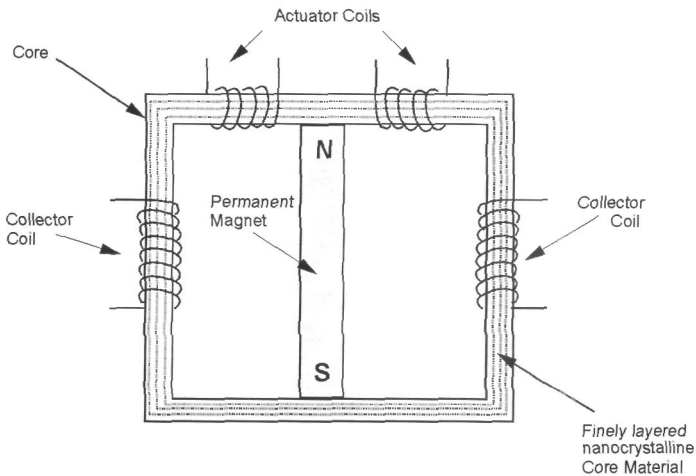

Figure 7-5 Diagrammatic drawing of the MEG.

Further, if one deliberately uses a nearly rectangular perturbing pulse that has very sharp rise time and very sharp decay time, the nonlocalized E-fields, resulting localized secondary B-fields, and resulting nonlocalized secondary E-fields produced can be made very large, with rapid rates of change also. In other words, the magnitudes of the nonlocalized E-fields and localized B-fields produced can be adjusted at will, including in their higher orders. The magnitudes of these evoked fields do not depend on the *magnitude* of the input perturbation energy, but on its *rate of change*. This

is very important, because it means the MEG permissibly achieves energy magnitude increase in its nonlocalized output E-field waves by simple instantaneous power deliberately prepared in its low-energy input perturbation waves.<sup>208</sup> In short, the motionless electromagnetic generator uses perturbation of the Aharonov Bohm effect as an energy amplifying mechanism.

This also affects all the iterative processes, hence all the other E-field waves produced outside the core material.

With the localization process remaining and ongoing (simply because the core material remains), the B-field continues to be stripped away, leaving the perturbed A-potential to produce a longitudinal E-field wave (ignoring the possible presence of a B(3) field also). In the MEG transformer section, the output (secondary) coils are wound around the nanocrystalline core that performs a B-field and B-flux localization within the core itself. Hence a purely net E-field interaction occurs with the electrons in the secondary coils, and the output of these coils is an output having the output voltage in phase with the output current.<sup>209</sup> The AC current in the secondary coils does in fact still produce magnetic field B-flux and B-waves in them, but the core material draws the extra B-flux and B-waves inside and localizes them within the core. The fact that localization is *not quite* 100% at the imperfect junctions of the ends of the permanent magnet and the core material, gives a tiny bit of leakage of

<sup>208</sup> It also means that the MEG operation is highly nonlinear, with very extensive feedforward and feedback field transduction loops. For the MEG, its scale-up, mathematical modeling, and engineering simulation are not simple things at all, but highly complex. In addition, control and stability are more complex, since one must utilize nonlinear oscillation theory (including chaotic oscillation theory) as well as nonlinear oscillation control theory. In addition, a higher group symmetry electrodynamics is required for the modeling and simulation. Consequently, because of these considerations and the geometric phase aspects, as well as the additional close-looping considerations for self-powering operation, an expensive physics lab must be established as well as the usual electrodynamics laboratory aspects. The result is an expensive final research and development program required to complete the MEG to final production prototype units, ready to start rolling off the assembly lines. A minimum capitalization of \$20 million is required.

<sup>209</sup> In the actual lab experiment MEG, there is a slightly imperfect junction between the ends of the permanent magnet and the core material. This results in a very tiny bit of leakage of nonlocal B-field —just enough to produce a 2° phase shift between the voltage and current in the secondary coil's output. With a better junction, this phase shift can be further reduced or eliminated.

B-field, so a tiny B-field component does escape, interact, and generate the 2% or so variation from the complete in-phase condition of the secondary output voltage and current. Again, that can be further reduced or eliminated by improving the junction.

So essentially there is a purely electric field interaction with the electrons in the output coil current of the MEG, hence the result that the output current is in phase with the output voltage — something previously unheard of in a simple secondary coil of a transformer. This is a major practical macroscopic application of the Aharonov-Bohm effect and therefore of the geometric phase.

## 7.6 Collection of Field Energy in the MEG

To collect and use EM energy in a power generating system, first the EM energy must be evoked from local spacetime (the local vacuum) by the broken symmetry of the source charges and dipoles in the circuit {12}. In the open system far from equilibrium in the resulting EM energy flow, the operator must usually pay for (i) the energy required to *initially* produce the requisite source dipolarity and (ii) the energy required to perform necessary switching and control functions, unless close-looping is incorporated. Using the permanent magnet as a source dipole in the MEG, and using the special nanocrystalline core material to generate the Aharonov-Bohm effect to furnish excess energy from the vacuum, the MEG operator does not have to *furnish* the evoked and available field energy at all. So the first "payment" is totally avoided. Further, the magnetic dipole is not destroyed by passing magnetic flux back through its back mmf. No additional input energy is required to continually restore the source dipole, since it is never destroyed.

In an open-loop MEG system, the operator only has to pay for the second part: the switching and control function energy. In later closed-loop MEG systems, a method of controlled and positive feedback has been developed so that, once the system is up and operating and powering its load, the necessary switching and control function energy can be siphoned off the output and fed into the input in governed fashion, first being transduced into positive energy input form. Once the process is properly synchronized and governing properly, the operator can throw a switch for feedback and transduction, and the unit will be "self-powering", or "fueled entirely by **the** local vacuum energy", so to speak.

Let us consider the open-loop MEG system we have presently attained in a series of embodiments.

The total emf force  $F$  collected from a given nonzero electric field  $E$ , e.g., depends only upon the amount of available intercepting charge, by the simple equation  $F = Eq$ . Similarly, from any potential  $\phi$  the amount of collected EM potential energy  $W$  depends on the amount of intercepting charge  $q$ , by  $W = \phi q$ . Hence in the MEG a legitimate COP>1.0 system is possible if (i) more energy is collected and used from the evoked EM energy flow than is input to gate that energy flow's appearance from the active environment, and (ii) none — or appreciably less than half— of the energy collected in the circuit is used to destroy the source dipolarity.

By invoking the AB effect in a local region, the vacuum contributes additional energy density in the space outside that region, and that energy density can be sharply perturbed so that substantial field energy amplification appears by asymmetrical regauging. The excess energy to provide COP>1.0 performance is freely furnished from the active vacuum (and from the local curved spacetime) {38b, 38c}. The excess energy can be intercepted in the perturbed curl-free A-potential region outside the transformer section, collected, and used to power additional loads, in addition to being intercepted in the transformer secondary region to power the secondary circuit and main load.

Similar contributions of extra energy and extra energy collection outside the core localization region occur for the iterative processes also.

At the same time, the B-field inside the core material is perturbed, but the core material self-varies its permeability to adjust to the additional magnitude of the perturbed B-field. The production of any B-field oscillation inside the core does produce an electric field  $E$ , which is not localized in the core. Consequently, energy from the perturbed core-localized B-fields is transduced into nonlocal E-field energy, passing out of the core and interacting with the output secondary coils of the transformer section in purely electric field fashion.

Because of the purely electrical interaction, the voltage and current output from the secondary coils of the transformer section are in phase, and not 90° out of phase as in a transformer. The actual 2° experimental phase shift of current with respect to voltage is a measure of the slight inefficiency of the junctions of the permanent magnet ends with the B-localizing core material.

In the MEG, we are using a novel new kind of component: an *external-induction-free cored inductor*, which might alternately be called a *purely electrical inductor* — at least externally. In short, the inductive action

remains localized in the core, while the electrical action escapes the core and interacts with the coil to drive the current electrically. So here is another excellent, novel, and practical use of the Aharonov-Bohm effect and the geometric phase: Eliminate the inductive reaction of a coil's output, and transduce it into a purely electrical action. At this writing, we are preparing to file a separate patent application upon this latest application and process, and it will already be filed by the time this book is published.

We accent that any field or potential, once made, already involves an ongoing giant negentropy and overunity process {486}, as we previously discussed in this book. Simply calculate how much energy it requires to separate and form the source charge — which can be as simple as charging a tiny little sphere — and recognize that the field formed by that charge is an altered energy density of surrounding space and a polarization of the vacuum. Once the charge is formed, the corresponding alteration and sustaining of spatial energy density change and vacuum polarization freely moves radially outward at the speed of light from the charge, from the very moment it is produced. So a steady flow of observable EM energy is speeding out in all directions from the source charge. An enormous change in the energy density over that external spatial region surrounding the source charge occurs and spreads steadily, moving radially outward in all directions at speed  $c$ .

Hence a magnificent and rapidly extending curvature of spacetime — which energetically acts upon any available charged matter therein, by conventional general relativity — is formed and spreads outward in all directions from any source charge, once formed. How much effect on charged matter is exhibited by this freely created and spreading spatial EM energy density change, depends only on the amount of interacting/receiving charged matter in that surrounding space that is available to interact with the energy of the new fields and new potentials.

If **the** source charge or source dipolarity (in this case, primarily the magnetic dipole of the permanent magnet) is left alone and not destroyed, an unlimited amount of energy can be intercepted and discharged from a local load, again and again, from the charge's surrounding field or potential because the energy in the field and potential is steadily replenished from the active vacuum. The only problem is discharge the collected energy in the load(s) so as to leave the original source charges (the magnetic poles) inviolate, and not to destroy them. The MEG accomplishes this function.

This also rigorously follows from the gauge freedom axiom of quantum field theory. Consider this: the ability to freely change the potential — assumed by all electrodynamicists — can be applied directly to the load to potentialize it without any current moving, if there exists a somewhat lengthy electron gas relaxation time in that part of the load that is potentialized. After potentialization, one can switch the source of free potential away, and complete the load circuit separately, so that the excess potential energy is dissipated from the load, powering it. In that case there is no dissipation of the primary source dipole. *Gauge freedom already assumes one can produce EM energy from the local vacuum freely, anywhere and at any time.* In real life, one has to pay a little for the switching, but not for the energy input itself.

Why the scientific community for decades has fiercely opposed the funded experimental investigation of the implications of gauge freedom is quite inexplicable.

As can be seen from the conservation of energy law alone, in theory energy can be continually intercepted and collected from these free fields and potentials, once the source dipolarity (or source charge) creation has been paid for. Further, by applying gauge freedom to potentialized the load without energy dissipation, with a little adroit switching the collected energy can then be dissipated entirely in a separated external load circuit, so that the free potential energy completely exits that circuit without re-interacting with the source dipole and its back emf or mmf.

We predict that the above application of gauge freedom will eventually power most of the world's electrical systems, when the scientific community gives up its present "ostrich position". Once the engineers can build it, the scientists do not have to agree.

That such is not done in our conventional circuits is purely due to the limited vision of the scientific community and its refusal to fund appropriate research. To date, it has not even recognized what actually powers every electrical circuit, or that a common practice (the closed current loop circuit) has eliminated  $COP > 1.0$  and self-powering Maxwellian power systems for more than a century. The entire electrical energy crisis hurtling at the nations of the world is due entirely to the shortsightedness of the scientific community, particularly since 1957.

Once the energy is pouring (transmitted) from the dipole and out of the terminals of the generator to fill space around the external conductors, then a straightforward energy transmission and reception problem exists. The source dipolarity produces the steady emission and flow of energy filling

space around the circuit. In the "receiving external circuit" the surface charges and their fields must intercept some of that available EM energy flow and diverge it into the conductors to power the circuit electrons. The intercepted and diverged component entering the circuit is the Poynting component, while the nonintercepted and nondiverged component missing the circuit and usually wasted, is the extra Heaviside component.

Fortunately, every source dipole pours out enormously more EM energy than our feeble conventional circuits intercept and catch to provide the Poynting calculations. So to produce  $COP > 1.0$  in the MEG, all we have to do is insure that we have (i) a mechanism easing the interception and collection process, and (ii) sufficient "antennas" containing sufficient conduction electrons (and their fields) to intercept and collect more energy than we pay to make the source dipole and perturb it. Since we pay nothing at all to make the source dipole (which is the permanent magnet), and since the magnetic flux back through the permanent magnet does not destroy the dipole, then all we have to pay for is the perturbation and for switching and control.

The resulting field energy generated outside the core localization region is primarily a function of the rise and decay times for the input perturbation pulses and not the energy of those pulses. From a little input energy with fast little changes, we can easily generate very powerful oscillating E-fields and provide dramatically increased "antenna collection" area with **the** necessary magnitude of intercepting charge. It rigorously follows that  $COP > 1.0$  is easily obtainable.<sup>210,211</sup>

<sup>210</sup> Again, for the MEG, changing and controlling the rise time and decay time of the input pulses is a method for directly engineering and controlling the general relativistic curvature of the local surrounding spacetime, because it controls the magnitude of the E-field that is created by  $\mathbf{E} = -\partial\mathbf{A}/\partial t$  from the curl-free A-potential outside the core. This also directly engineers and controls the magnitude of the polarization of the local active vacuum. That simple fact allows the use of a unified field theory operation, with a net energy interchange between the system and **the** local active vacuum. To understand the MEG, one must think in terms of the *supersystem*.

<sup>211</sup> All EM energy at any point in space must have been "gated" from the time-domain and it must return to the time domain (as, e.g., by the source charge for it). It **requires** quite a shift of one's mind to realize that all 3-space energy (such as "energy at each point in a potential") involves a gating process and a giant neginotropic 4-circulation of EM energy ongoing at each point dipole. Much of the extraction of **energy** from the vacuum has been hidden by thinking in terms of "inputting energy" instead of "inputting or arranging energy flow gating" by the source charges and sourcedipoles.



The MEG is an open system far from equilibrium with its active environment (its active local vacuum and its active local curvatures of spacetime). By attending to the interception and collection part of the overunity problem, the MEG can permissibly collect and use more EM energy to power its loads than one oneself has to input to it. In short, one only has to input a little switching and perturbation energy with properly shaped waveforms, to generate very powerful fields and appreciable field energy available for collection and use. With sufficient collection mechanisms in place, the unit easily produces  $COP > 1.0$ . Then with proper closed-loop principles implemented, the MEG can be self-powering.

## 7.7 Experimental Path to Development of the MEG

In our experiments with the Radus effect previously discussed in Chapter 6, paragraph 6.4.5, we had already done extensive work with switching magnetic fluxes for less switching energy than can be intercepted from the switched flux. We had also experimented with various cores for transformer and coil variants, including eventually the new layered nanocrystalline cores.

In our experiments, we noticed a remarkable thing. With certain modern nanocrystalline core materials, and using a permanent magnet to provide B-flux, we found that *the core material would extract and hold essentially all the permanent magnet's B-flux inside the core*. Field measurements right against the outside of the poles of the powerful little neodymium-iron-boron magnet itself showed very little B-flux spilling out into space! In short, we had discovered how to make a magnetic system that *nonlocally* propagated only the uncurled magnetic vector potential A, without any operator energy input. We realized we had discovered a marvelous and free way to freely obtain an excellent Aharonov-Bohm effect, similar to the way a nearly perfect toroid would localize the B-field inside the core, with the uncurled A-potential appearing in space surrounding the toroid. The advantage of our approach over the toroid was that we did not have to furnish any current and voltage to obtain the localized B-flux and the non-localized curl-free A-potential energy.

Further, if we perturbed the B-field flux in the core, we consequently perturbed the uncurled A-potential in space surrounding the core. From both sources — the perturbed B-flux in the core and the perturbed

A-potential outside the core — we could produce very large E-fields and concomitant very large voltages capable of driving more "power" through the secondary coils of the transformer section than the power required to perform the switching and perturbation.

We could easily prove this by perturbing the localized B-flux (and the concomitant surrounding uncurled A-potential automatically) with weak energy. We proved that increasing the rate of the rise time and decay time of even a weak input EM energy perturbation could produce quite large E-fields, including 1,000 to 5,000 volts (or even 20,000 volts!) appearing in the secondary coil if desired. We also proved another thing: *the special nanocrystalline core material in some buildups self-adjusted its permeability, continuing to localize the perturbed and alternating B-fields and their fluxes while freeing the resulting E-fields and passing them out of the core.* In short, the permeability of the specially selected core material automatically adjusted with the perturbation of the localized B-flux and nonlocalized A-potential, so that all the oscillating B-flux remained localized in the core. Further, the highly layered nanocrystalline material produced essentially no eddy currents at all, hence no heating, even in the presence of dramatic B-flux oscillation and dramatic E-field intensities in the surrounding uncurled A-potential space and in the output (secondary) coils of the transformer section of the MEG.

The absolute proof that the core changed its permeability was in the lack of a phase lag between voltage and current in the output from the output coils. Here a remarkable thing was observed: the output current was in phase with the output voltage, within about  $2^\circ$ . In short, under certain circumstances the output coils wound around the nanocrystalline core would exhibit essentially a purely E-field interaction, with only minuscule B-field leakage — something deemed impossible in the typical electrodynamics textbook. This meant that the excess E-fields produced by the perturbed A-potential in space outside the core also reacted with the **output** coil's conduction electrons in a purely electrical manner! This was because the B-fields locally produced in the output coils by the interacting changing E-fields, *were in fact instantly drawn into the core material as they were produced, and were held there so they did not react in magnetic fashion with the electrons in the output current from the secondary coils.*

So this is a dramatic localization of Faraday's law of induction. Consequently, one entire group of embodiments of the MEG uses a purely electrical interaction with the secondary (output) coils of the transformer

section.<sup>212</sup> Or more exactly, the core material draws in all the magnetic fields from the reactions of the output coils, leaving only the electrical reaction outside the core — including in the coil conductors, which obviously are wound outside the core material.

On the other hand, the perturbed localized magnetic B-flux inside the core material did produce the normal E-field to be expected, as a function of the time-rate of change of the B-field. Such an E-field is not localized in the core material, but extends outside the core and interacts with the electrons in the output secondary coils of the MEG's transformer section. Again, the magnitude of this E-field is a function of the time-rate of perturbation of the localized B-field flux in the core.

The nanocrystalline core also has excellent high frequency response, with negligible eddy currents. Thus we can "fine tune" the engineering of the rise time and decay time of the input perturbation pulses.

Hence we accomplish several kinds of "gated energy amplification" in the MEG: (i) the amplified magnitude of the external E-field interacting with the external collectors (such as the output secondary coils) due to perturbation of the nonlocalized external uncurled A-potential, (ii) the amplified magnitude of an additional E-field interacting with the external collectors (such as the output secondary coils) due to perturbation of the localized internal B-field flux inside the core material, (iii) a large number of additional derivatives of higher order B-fields and E-fields are formed and utilized, and (iv) adding additional collectors (either coils wound on the core or external "receiving antenna circuits" produces additional power for heavier loads, for a given perturbation input.

We had exhibited a cored output coil with a remarkable adaptation of the AB effect. Essentially the output of the secondary coil was driven by the large electric field component created from the uncurled A-potential perturbations *and* by the large electric field component created from the B-field flux perturbations inside the core. This peculiar transformer-like section operated from the E-field fluxes emerging or produced *outside* the

<sup>212</sup> Again we accent that the magnetic field reactions do occur, and the B-fields are in fact produced. But the resulting B-fields are also extracted into the core material and localized therein. Even the magnetic B-fields produced in the input and output coils themselves, is so localized and not allowed to interact with the electron currents through the coils to produce the conventional 90° phase lag between voltage and current.

transformer core material, rather than from the magnetic field flux being produced and oscillated *inside* the core material itself.

Obviously we had found a remarkable but legitimate  $COP > 1.0$  process and embodiment — in fact, a whole set of them. We had also invented a new kind of "transformer" or energy generator-transducer.

From that we progressed to discovering ways to a dual use of both the perturbed B-flux in the core and the E-fields from the perturbed A-potential outside the core. To first order, that turned out to be fairly simple: any changing B-flux inside the core material and thus inside the output (secondary) coils of the transformer section, produces not only B-field which is held and localized, but also the changes of this local "pinned" B-field further produces E-field oscillations which are not pinned in the core. Hence the electric field half of a normal transformer action could and did occur in the secondary coils, but the magnetic field half did not occur *in the coils themselves*. The MEG used and uses a nearly pure E-field interaction in the output coils of its transformer section secondary, where that net interacting E-field comes from a variety of E-field generating mechanisms.

We filed our first patent, and then filed a second patent application soon after. Presently we are preparing to file our third and fourth patent applications on additional phenomenology and mechanisms uncovered in our experiments. As we are writing this section, our first patent has issued {37}.

In the view of the present author, we have uncovered a remarkable new application of the Aharonov-Bohm effect and the geometric phase, one that is practical and eminently useful in novel new electrical power systems.

## 7.8 Additional MEG Functions

Figure 7-6 diagrammatically shows the core material inside the input coil for either open-loop operation using an external power supply or closed-loop (self-powering) operation using clamped and governed positive feedback. As can be seen, the B-field and B-field flux are confined to the core material (which is in the form of a closed transformer coil path, as shown diagrammatically in Figure 7-5). The external space surrounding **the** core material is filled with the uncurled A-potential, due to the Aharonov-Bohm effect being imposed by the core material. The two leads from the input coil are shown at the bottom of Figure 7-6.

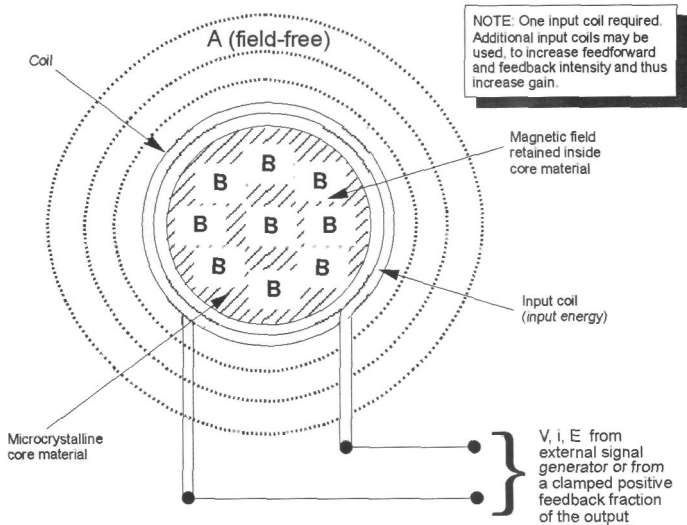

Figure 7-6 Input coil for open- or closed-loop operation.

We pulse the input coils with nearly rectangular pulses each having a sharp leading edge and a sharp trailing edge, so that the resulting rapid time-rates of change of the two edges create very large perturbations of the B-flux in the core and of the A-potential outside the core. The large  $E_2$ -field resulting from the fast rate of change of the perturbed B-field in the core is not localized, but appears in space outside the core. In addition, an  $E_3$  field created directly in the coil itself also appears in space outside the core. In addition, the sharply perturbed A-potential outside the core creates a third large  $E_1$ -field in space outside the core. The net  $E_t$ -field in the surrounding outside space is the vector summation of the E-fields produced by these processes, or to first order (neglecting the further differentiations)

$$\mathbf{E}_t = \mathbf{E}_1 + \mathbf{E}_2 + \mathbf{E}_3 \quad [7-1]$$

We also may adjust the pulse width to generate a further Lenz law effect, increasing the three component fields  $E_1$ ,  $E_2$ , and  $E_3$  if desired. To do that, the pulse must be narrow enough to suddenly decay while each of the fields  $E_1$ ,  $E_2$ , and  $E_3$  is still rising and not yet reached maximum. As can be appreciated, considerable pulse shaping and timing can be adjusted for optimization of the output voltage, current, and power when interception and collection from  $E_t$  is accomplished in the secondary coils. In addition, it can be appreciated that slightly differing materials delay times do occur in the production of  $E_1$ ,  $E_2$ , and  $E_3$ . Hence there is appreciable

optimization that can be and is accomplished on a given MEG variant and build-up type.

More complex waveforms of various shapes can be used to further optimize the output. It is also possible to accomplish further optimization and control by adjusting the shapes and timing of the feedback signals in the case of the closed-looped MEG system. For the externally powered open-loop version, additional optimization and control can be achieved by adding additional simultaneous pulses fed into the input coils in various fashions.

In addition, the response of the output coils produces feedback into the core material, into external space, and into the input coils. These in fact provide three more E-field *return* or feedback inputs, so that the total feedback input is

$$\mathbf{E}_f = \mathbf{E}_4 + \mathbf{E}_5 + \mathbf{E}_6 \quad [7-2]$$

Without doing the more complex iterations for this feedback and feedforward set of loops, to first order the total input  $\mathbf{E}_t$  to the input coil may be considered to be

$$\mathbf{E}_t = \mathbf{E}_t + \mathbf{E}_f \quad [7-3]$$

Equations [7-1], [7-2], and [7-3] are for simple analogy only; in the real MEG, full nonlinear feedforward and feedback analysis techniques must be utilized because of the iterative operations, and much more sophisticated optimization techniques are appropriate. Also, chaotic oscillations can and do appear, and techniques for control of such oscillations are indicated, particularly along the lines indicated by Fradkov and Pogromsky {487} without use of probability etc. Quoting:

*"1. There is ... great benefit of using the modern nonlinear and adaptive control theory. ...2. There is no need to distinguish periodic and chaotic behavior. Accurate control is possible without accurate prediction. ...3. There is no need to define chaos in order to control it. ...4. There is no need to use probability in order to control systems with seemingly random behavior. "*

**For** any given MEG build-up design, one experiments with these optimization and control factors and mechanisms to provide the best performance, and to provide rock-steady performance.

**Figure 7-7** shows the output coil for either open-loop operation from an external power supply or closed-loop (self-powering) operation using

clamped and governed positive feedback. Here the situation is partially reversed. There are three major inputs to the output coils, and these are (i) the external input from the total outside E-field, (ii) the internal input from the perturbation changes in the confined magnetic flux inside the core through the output coils, and (iii) the ensuing feedforward and feedback from all E-fields.

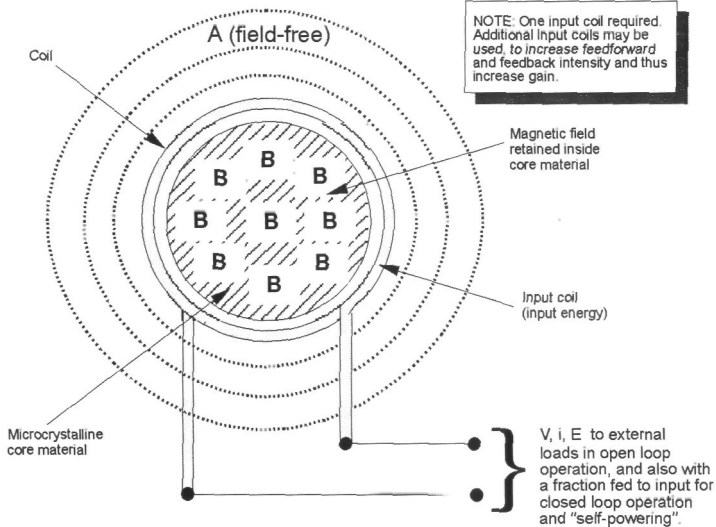

Figure 7-7 Output coil for open- or closed-loop operation.

Again, this is simply an easy way to visualize the situation to first order. In the real case, sophisticated feedforward and feedback analysis is required and utilized. Optimization usually consists of two steps: (1) the simpler, more direct optimization techniques such as adjusting pulse width, pulse rise time and decay time, actual pulse form, etc., and (2) the deeper and more complex optimization arrived at from detailed feedback and feedforward loop analysis as well as nonlinear oscillation and nonlinear control theory analysis.

In the actual optimization analysis, the feedback and feedforward loops are mathematically endless and thus should be optimized for quick decay and stability. On the other hand, the MEG also has the ability to self-oscillate over the entire unit, in which case the feedback and feedforward loops are optimized for stable self-oscillation of the entire unit. The self-oscillating

MEG is permitted since it is an open system far from equilibrium with its active environment.

So if desired, an entirely different kind of optimization can be utilized for self-sustained nonlinear oscillation and closed loop operation. Because of the gain achieved in the large E-fields produced by the perturbed uncurled A-potential in space surrounding the core, there is sufficient excess energy collection available in the output coils to use the available feedback and feedforward loops in the system itself to achieve system self-oscillation. The system can be operated as a self-oscillating open system freely receiving excess EM energy from its active environment — the local active vacuum, local curvatures of spacetime, and local freely furnished uncurled A-potential and resulting nearly free E-fields from the A-potential's perturbations). As we are writing this, our experiments are now in this direction, and we are preparing the material for filing a formal patent application on this additional process. The patents will be filed, of course, by the time this book is published.

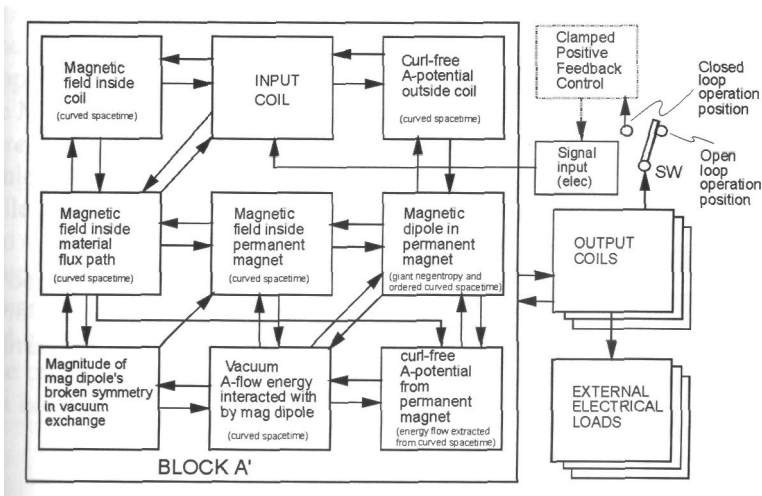

Figure 7-8 Energy gain process using feedforward and feedback subprocesses

A highly simplified block diagram of energy gain process using feedforward and feedback subprocesses is shown in Figure 7-8. As can be appreciated from this high order diagram, the actual feedforward and feedback loops are extremely complex, and a great deal of complex analysis is required for a self-oscillating, stable, controlled system. We also stress that control measures to insure and hold stable self-oscillation



must be included in the overall features implemented in this self-powered, self-oscillation variant of the MEG. Not only must we use chaotic oscillation techniques to achieve the self-oscillation, but also we must use advanced techniques for stable control of such nonlinear oscillations, as indicated by Fradkov and Pogromsky {487}.

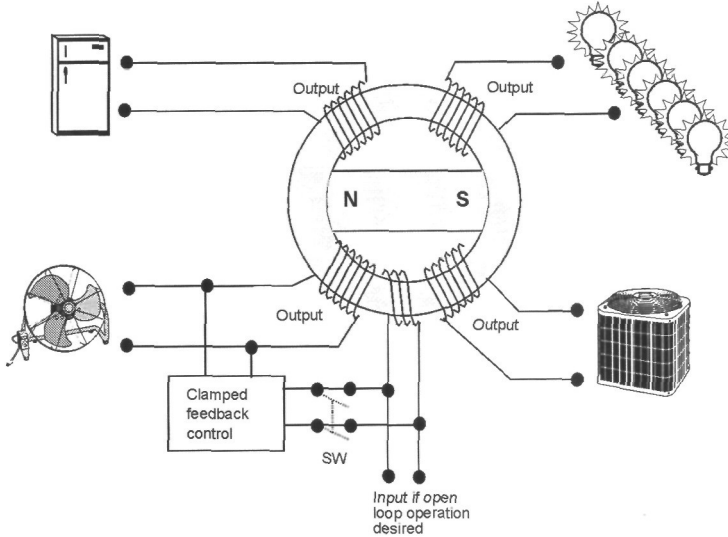

Figure 7-9 Typical MEG embodiment application on site.

In Figure 7-9, we show a typical diagrammatic embodiment envisioned for the MEG in a household, using a large MEG to later be developed. For interim installations, the single large MEG will be replaced with an array of MEGs together with a synchronizer, as shown in Figure 7-10.

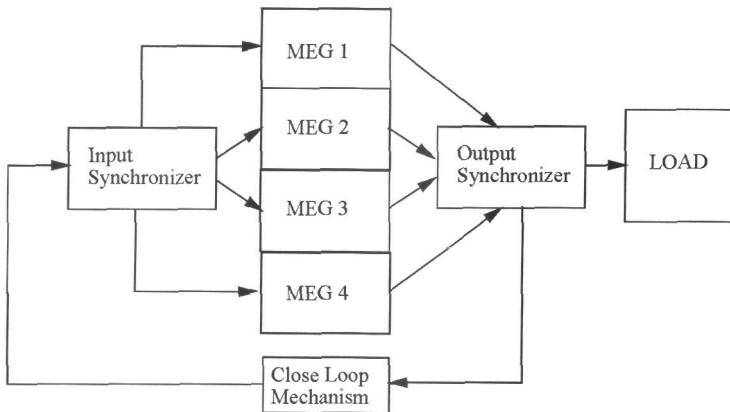

Figure 7-10 MEG self-powering array concept for increased powering applications.

Figure 7-11 shows a MEG unit where additional special collection antennas feeding separate circuits are employed in an "outrigger" fashion. One major advantage of this configuration is that the complexity of close-looping and its control are materially reduced, although the complexity of the MEG build-up and stabilization is increased. Another advantage is the *ease* with which close-looping for self-powering operation can be achieved, as shown in Figure 7-12. In this case, the external antennas are collected to independent output circuits (not shown) in the output section, and each of these independent outrigger outputs is a  $COP < 1.0$  circuit if we count the perturbed A-potential energy input as an "operator's" input. Completely normal clamped positive feedback can be used with sensing and governing, to allow self-powering and self-adjusting to varying loads. The outrigger embodiment can be made to almost entirely avoid the Dirac sea hole current problem.

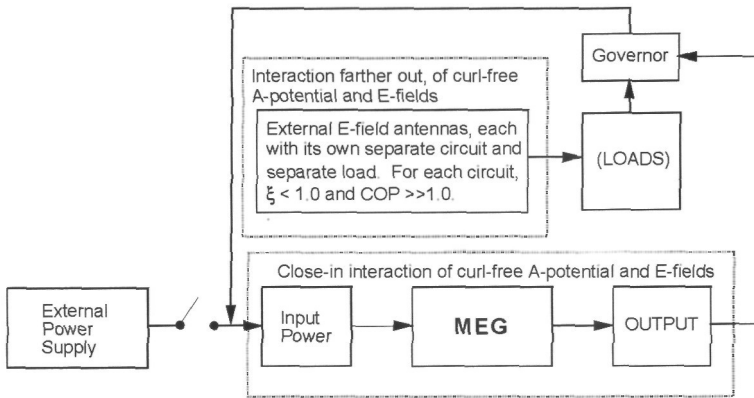

Figure 7-11 MEG unit with outrigger antennas for extra energy collection.

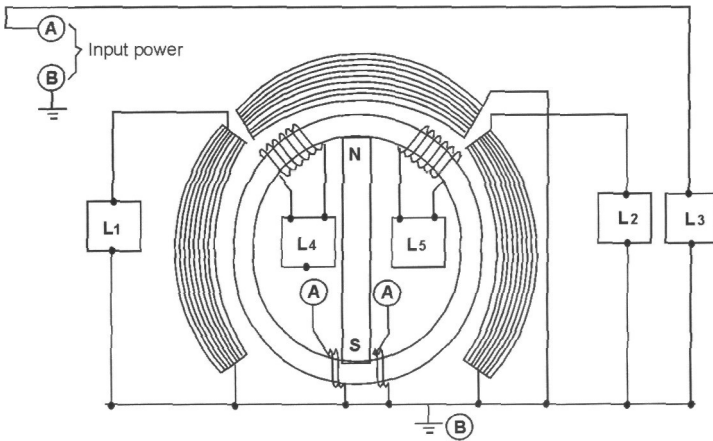

Figure 7-12 Use of outrigger antennas for damped positive feedback method of close-looping.

As can be seen, the MEG has many possible configurations and embodiments, each of which has special advantages and uses. One of the embodiments we discussed is the deliberate use of self-oscillation forced by the feedforward and feedback loops. That is a separate embodiment, and capable of a very high power per pound ratio, but it also requires more sophisticated sensing and control techniques.

## 7.9 In Conclusion

By the time this book is published, Magnetic Energy Ltd. is hopeful it will have achieved its major funding requirement, and be well along the way to completing the research for full production and marketing of MEG units on the world market. We have arrived at that part of development — the need for substantial funding (several tens of millions of dollars) — where every previous COP>1.0 EM power system has died. We intend to do everything within our power to see that we obtain the funding, finish the complex research task, and get the MEG onto the world market.

For additional information on the MEG and on its preliminary replication by Naudin, the reader is referred to other technical articles {488} and to Jean-Louis Naudin's website.<sup>213</sup> Actual measurements for one of Magnetic Energy Ltd.'s MEG test units is given in reference {488a}. The MEG patent {37} shows the variation of COP for a test MEG with various conditions. Curves for Naudin's measurement of the performance of his replicated MEG unit are given on his website.

The MEG project is a most interesting project, because of the involvement of so much advanced physics and several different physics areas, as well as the prerequisite for higher group symmetry electrodynamics. Once funded, we are confident we succeed in crashing through the barriers and getting working MEG power units — including self-powering MEG units — on the market. We also believe the MEG will represent a substantial contribution to alleviating the coming worldwide energy crisis. Hopefully it will materially hasten the growth and evolution of the present highly centralized — and terribly vulnerable — national energy infrastructure into a highly decentralized — and much less vulnerable — national energy infrastructure. We also believe it will provide a great contribution to helping alleviate global warming, reducing pollution of the biosphere, and reducing the production of hazardous wastes. If so, it will be a continuing

<sup>213</sup> Naudin's website MEG material and information is at <http://jnaudin.free.fr/html/meg.htm>. Particularly see his Mark III replication, shown powering a light on that webpage.

contribution, not only to humanity today, but also to generations yet unborn.

# Chapter 8

## Approach to Antigravity

[Large-scale antigravity exists] *"...baryonic, ordinary matter—the stuff of stars and of people—makes up just over 4% of the energy and matter in the universe. ...about 30% of the stuff in the universe is dark [unobserved] matter. The remaining two-thirds, theorists believe, is a mysterious 'dark energy' or 'quintessence'—a large-scale antigravity-like effect that is making the universe expand ever faster.... "* [Charles Seife] {489}.

[On the nature of the vacuum] *"...the (electromagnetic) vacuum is the ground state of the quantized electromagnetic field. ...The Dirac electron vacuum is that state with all negative energy electron states fully occupied."* [Aitchison] {490}

[On forces and how charge exists] *"Vacuum polarization, in general, alters the effective force law. Forces, in quantum field theory, are understood as being due to the exchange of virtual quanta ...In the case of QCD and QFD, ... a crucial new feature is that the force-field quanta themselves carry the 'charge' of the force-field, i.e. it is as if the photon of electromagnetism carried electromagnetic charge."* [Aitchison] {491}

[Possible gravitational circuits] *"There is an implication ... that gravitational excursions might be controllable by gravitational 'circuits', analogous to electronic circuits, which could lead to a controllable form of negative gravity."* [Robert Neill Boyd] {492}.

[Gravitational circuits] *"The supersystem concept utilizes a unified fields approach so that specialized electrical circuits in COP» 1.0 condition generate strong Dirac sea hole currents of negative energy in the immediate local vacuum. Thus a strong negative energy field is formed surrounding the circuit and changing the curvature of local spacetime as an action by the source*

*circuit. This produces a direct antigravity field around the circuit or physical system, acting upon the mass of the system. The net gravitational interaction by that circuit or physical system is therefore the summation of the local positive gravitational field and the new local negative gravitational field produced by that negative energy field.*" [T. E. Bearden, correspondence to a colleague, February 2002.]

[On the multiplicity of spacetime curvature components] *"The full mathematical expression for the curvature of four-dimensional space-time ... is given by something called the Riemann curvature tensor. This is a somewhat complicated object, needing twenty real numbers at each point in order to specify it. These twenty numbers are referred to as its components. The different components refer to the different curvatures in different directions in the space-time."* [Penrose] {493}.

[Physics studies and prepares imperfect models, not perfect truth] *"All we ever know is our models, but never the reality that may or may not exist behind the models and casts its shadow upon us who are embedded inside it. We imagine and intuit, then point the finger and wait to see which suspect for truth turns and runs. Our models may get closer and closer, but we will never reach direct perception of reality's thing-in-itself"* [Hawking] {494}.

## 8.1 Introduction

In this chapter, we first present a highly abbreviated background of the theory of gravitation, sufficient for our experimental orientation. Of special interest are unified field theories, which cover general relativity, electrodynamics, and quantum mechanics in one overall master theory. Even more of interest is an engineerable unified field theory, which is presently closest approached by the theory of Mendel Sachs {510}.

We then present a short overview of work that has been done in the fields of lifters and inertial propulsion, listing some of the inventions of interest, the approaches, results achieved, and our comments on each.

Finally, I present my own approach to antigravitation, and give some results of the Sweet device's antigravity test (the test was designed by the present author) that successfully reduced the weight of a device by 90%.

In our view, this experiment fully demonstrated the veracity of our theoretical approach.

## 8.2 Selected Theories of Gravitation

### 8.2.1 Newton's Theory and a Negative Mass Extension

The first mechanism for gravity of interest to our purposes was advanced by Newton in his work on mechanics {495}. Newton's law of gravitation may be stated as {496}:

*"A particle of mass  $m_1$  attracts a particle of mass  $m_2$  a distance  $d$  away with a force  $F = G \frac{m_1 m_2}{d^2}$  in the direction of the line joining the particles. "*

Of course, it should have stated "in a time forward zone". The situation is precisely reversed in a time-reversal zone. It is also reversed for negative mass-energy.

In the Newtonian view, antigravity would mean repulsion of mass rather than attraction of mass. Given that negative mass is possible, then a negative mass would exhibit antigravity — i.e., it would be repelled by all other positive masses.<sup>214</sup> This can be seen in the quoted equation, by

<sup>214</sup>The discussion of what attracts what and what repels what, in a mix of negative and positive masses and negative and positive energies, is still controversial in physics. Different theorists have taken differing positions, and there is no formal experiment that has decided between them. In our opinion, the successful antigravity test of the Sweet vacuum triode amplifier answered that question experimentally, although independent replication was not accomplished. The scientific discussions heavily involve discussions (and assumptions) of the nature of "gravitational" mass, inertial mass, and electrodynamic mass etc. Again, there is no decisive selection among several possibilities, and there is no clear and universally accepted definition of **any** of those three types of mass.

In addition, all the discussions have included a fundamental error: They **assume** a separate 3-force acting upon a separate 3-mass, which is unequivocally false. Another fundamental error is the assumption of an observed (effect) 3-positron interacting with normal matter rather than a non-observed (causal) 4-positron (negative energy 4-electron) in massfree spacetime. In effect, this applies the CPT (charge-parity-time) symmetry, and converts the direction of the 3-positron to the antidirection of the 4-positron while also changing the negative mass of the 4-positron to positive mass of the 3-positron. Further, in physics there is still no firm **definition** of either force or mass, but only circular definitions between the two. We are using the simple definition of mass as  $F = d/dt (mv)$ , where mass is a component of force  $F$  and hence there is no separate force  $F$  acting upon a separate mass  $m$ . We



interpret that equation as "the force  $F$  observed in a new observation is proportional to the time-rate of change of the ongoing 4-space interaction between the just-observed 3-mass  $m$  and the average interchange of time-energy and space-energy represented by  $v$  in the ongoing dynamics between spacetime and mass  $m$ . Whatever adjective is prefaced upon the  $F$  is also prefaced upon the  $m$  in the  $mv$  term.

We politely but firmly disagree with one prevailing notion that positive mass *attracts* both positive and negative mass, while negative mass *repels* both types. Further, we believe that the Sweet vacuum triode amplifier antigravity experiment falsified that notion. We hold to the dictum that  $m = E/c^2$ , where  $E$  is real spatial energy and may be positive or negative,  $c^2$  is always positive, and therefore negative mass is highly compressed negative spatial energy while positive mass is highly compressed positive spatial energy. (Imaginary mass is a separate consideration.) We also prefer to reason in "single fundamental units" physics where the joule is the only fundamental unit. Gravity then becomes a function of the joule, whether electromagnetic, mechanical, or whatever. *We consider the energy in spacetime to be the source of the curvature of spacetime that is known as "gravitational field"*. If the joule is of positive energy, the accompanying gravity is positive. If the joule is of negative energy, the accompanying gravity is negative. And we consider gravity as the 4-space causal spacetime curvature. So for gravitational interaction theory, we insist on examining the interaction of the curvature of local spacetime with the mass-energy. Further, we postulate that the gravitational effect upon one mass from a second mass is an improperly posed concept. It actually is an effect of the local curvature of spacetime around the first mass, where that curvature of spacetime was induced by the second mass's energy. Further, we consider that positive energy fields surrounding a positive mass will curve spacetime in the "positive gravity" direction. The positive mass is attracted by all other positive masses. Negative energy fields surrounding that positive mass system curve spacetime in the "negative gravity" direction so that the positive mass of the system is at least partially repelled by all other positive masses in the universe.

We further prefer to think in terms of the *supersystem* and the unobserved causal 4-field, not the frozen iterative 3-field snapshots defined only after iterative observations. As we stated previously, the "observed" 3-positron is, in our view, a very different beast from the as-yet-unobserved 4-positron. The 3-positron is a frozen momentary "effect" entity with no dynamics at all and no continuous existence in time (and hence in spacetime) at all; instead, it continually *recurs* as the iterative effect of iterative observation by iterative application of the  $d/dt$  observation operator. The 4-positron is still a negative energy electron with negative charge, and still going in a non-reversed direction since broken parity has not been applied (because observation has not been applied), a causal entity with ongoing dynamics, continuously existing in spacetime, not just in 3-space. Until interacted and observed, it also has negative energy and negative mass-equivalency.

If one wishes to accurately deal with spacetime effects from the "positron," in our view one must deal with the 4-positron before observation, and hence with the supersystem. The 3-positron is not a *spacetime* entity, but only a frozen *3-spatial* snapshot. Scientists, including Dirac himself, were horrified at the negative mass implications of the negative energy states. Therefore, they moved the interpretation

simply replacing positive mass  $m_1$  by negative mass  $-m_1$ . That two negative masses would attract can be seen by replacing positive mass  $m_1$  by negative mass  $(-m_1)$ , and also replacing positive mass  $m_2$  by negative mass  $(-m_2)$ .

Now consider mass  $m_1$  to be the rest of the net positive mass in the universe, and mass  $m_2$  to be the "effective" mass in a local supersystem consisting of the local physical system, its local active vacuum, and its local active curvatures of spacetime — in short, in a local supersystem consisting of the physical system and its local active environment, and the interchanges between them. Let  $m_2 = m_p + m_n$ , where  $m_p$  is the amount of local positive mass (or mass-equivalent) in the system and  $m_n$  is the amount of negative mass (or mass equivalent) in the system. This supersystem now simultaneously exhibits both positive gravity (attraction) to all net positive masses in the universe and negative gravity (repulsion) to them as well. The net gravitational response of the supersystem depends upon the fraction of the effective mass that is positive and the fraction that is negative — in short, upon the net vector sum of the two gravitational forces.

to the 3-positron, and thereby twisted the interpretation to substitute the effect for the cause. Hence circuit theory treats the *lattice hole* as a positron, yet that "hole" acts very differently from a true Dirac positron (a Dirac sea negative energy electron) in free space.

Consequently, matter-antimatter interactions and the interaction between positive energy and negative energy are quite different, or they can be if so manipulated prior to observation. In the matter-antimatter interaction, the initial curvature of spacetime formed by the union decays by radiation of EM positive energy and the "effect particles" disappear back into the uncurved vacuum from whence they came. In the positive energy and negative interaction, there is a change of the local curvature of spacetime without its decay and subsequent re-radiation of EM energy. Equal amounts of interacting positive and negative EM field energy thus are simply transduced into stress energy potential of the vacuum and consequent sustained change in the curvature of the local spacetime. Indeed, the radiation of pair annihilation energy is obtained only at the expense of negating (relaxing) the local polarization of the vacuum (and the two consequent curvatures of local spacetime) represented by the independent positron and electron. Indeed, normal pair annihilation is a sort of Lorentz symmetrical regauging of the locally asymmetrical vacuum.

The reader is certainly free to disagree with our conclusions; we are merely explaining them. Experiment will eventually sort out the truth or falsity of the approach. So far, based on the Sweet experiment designed by the present author, a highly successful experiment was consistent with this approach.

In a "mixed" mass system containing both positive and negative component masses, the fraction of the total mass that is positive and the fraction that is negative is thus significant. When the mixture's negative mass is less than its positive mass, the mixture would exhibit a "reduced" gravitational attraction to other masses of the universe. Then the ratio of negative mass to positive mass might be taken as the "gravitational shielding" coefficient (fraction).

When the amount of positive mass and the amount of negative mass were equal, the overall mass system would exhibit no net gravity or antigravity, and would "float" or "hover" in the Earth's gravitational field. It would be equally attracted and repelled by the Earth's positive mass (and by all other positive mass in the universe, hence could — at least under certain conditions — *appear inertia-free.*). When the amount of negative mass exceeds the amount of positive mass, the overall mass system would exhibit a net antigravity effect. It would be repelled more strongly by the Earth's positive mass, as well as more weakly by the distant positive masses of the universe, and hence would accelerate upwards and away from the Earth. Notice that the key to antigravity in the Newtonian approach is the availability of negative mass, but in the new sense in which we use it. Note also that we did not discuss the separate issue of imaginary mass.

If we translate that into modern terms, where we consider not the "mass" but the condensed energy comprising the mass, then  $m_p$  and  $m_n$  become positive mass-energy and negative mass-energy terms respectively. Given the ability to produce electromagnetically produce substantial negative field energy in the immediate vacuum environment of the system, where the source of the field is the physical system, then the creation of a direct antigravity component in the system's environment — the other two components of its supersystem — becomes not only possible but also feasible.

The key to antigravity becomes the *availability of negative field energy in the local space surrounding the physical object, with the physical object containing the source of that surrounding spatial negative energy field.* Voila! This impels us directly to electrodynamics and a modified Dirac sea {497, 498a, 498b), one with excess empty holes as source charges producing negative energy EM fields. We deliberately create these unique source charges by actions taken in a COP»1.0 system. This gives the key

to the approach to antigravity taken by the present author.<sup>215</sup> However, we use as negative energy not just the accounted *Poynting* energy flow component in space where the field is present, but also the unaccounted *Heaviside* energy flow component, which is much greater in magnitude (in a nominal case, nearly  $10^{13}$  times greater). In this way, we dramatically increase the amount of antigravity effect that can be obtained by a given EM power dissipation in the physical electrodynamic system itself. *This antigravity effect of a Heaviside component of EM negative energy flow has not been accounted in previous analyses.*

### 8.2.2 Riemann Surfaces and Riemann Geometry

The next development of interest to us is the doctoral thesis of Riemann {499}, which founded the theory of Riemann surfaces. Three years later, **he** founded Riemann geometry in a famous lecture. Riemann was working on a unified explanation of gravity and electromagnetism when he died of tuberculosis a dozen years later. It was Riemann's multiply-connected topologies that eventually resulted in the view of electric charge producing lines of force trapped in the topology of space {500}. Had Riemann lived, we believe that engineerable unification of electrodynamics and gravity would have occurred early on. In that case, we might have already had practical antigravity vehicles and explored the solar system and beyond.

### 8.2.3 Heaviside's Excess Energy Circulation Flow and Gravity Theory

**The** next theory of gravity of interest to us is that of Oliver Heaviside. Heaviside noted that his extra EM energy flow term was a trapped EM energy circulation {501}. He realized that, if that trapped EM energy circulation were taken as gravitational in nature, his energy flow theory could be converted into a unified theory incorporating both electrodynamics and gravitation. After his death, his handwritten notes on **the** theory were found beneath the floorboards in the little garret apartment he had long occupied. No one knows what other papers he may have had; **the** place was ransacked and looted prior to the discovery of these remaining papers hidden beneath the floorboards — papers the looters had missed.

<sup>215</sup> We also point out that a Dirac sea with empty holes (excess negative energy states) exists in (or constitutes) a negatively curved spacetime *a priori*. So we get back to the other two components of our "supersystem", the active vacuum and its dynamics and the local curvature of spacetime and its dynamics.

Other scientists such as Laithwaite have felt that Heaviside's approach might still shake the foundations of physics itself. Quoting Laithwaite {502}:

*"Heaviside had originally written the energyflow as  $S = (ExH) + G$ , where  $G$  is a circuital flux. Poynting had only written  $S = (ExH)$ . Taking  $p$  to be the density of matter and  $e$  the intensity of a gravitational force, Heaviside found that the circuital flux  $G$  can be expressed as  $pu - ce$ , where  $u$  represents the velocity of  $p$  and  $c$  is a constant."*

### 8.2.4 Mach's Principle

After Heaviside, the next item of interest to us is Mach's principle {503}, which essentially states {504}:

*"The properties of space have no independent existence but depend on the mass content and distribution within it. Thus, acceleration dealt with in Newtonian mechanics can only have meaning if it is an acceleration with respect to the stars or with respect to something equally well-defined."*

Mach's principle does not adequately deal with spacetime, and certainly does not even acknowledge or encompass how energy exists in 3-space at each point dipole, as an entering flow from the time domain into the negative (charge x time). It does not include transduction by the negative charge into 3-space energy, passage of the 3-energy to the associated positive charge, transduction back into time energy by the positive charge, and re-emission of the transduced time-energy back into the time domain, by the positive charge. In short, Mach's principle will never get one a practical antigravity system, regardless of how one applies the principle.

### 8.2.5 Einstein's General Relativity

Next comes Einstein's epochal general relativity theory of gravitation {505}. In that theory, Mach's principle is interpreted as pointed out by Misner, Thorne and Wheeler {506} in the following quote:

*"...Einstein's theory (1) identifies gravitation as the mechanism by which matter there influences inertia here; [and] (2) says that this coupling takes place on a spacelike hypersurface..."*

The great contribution of Einstein's general relativity was to remove the notion of the "field occupying space", where field and space are separate things. Quoting {507}:

*"If we imagine the gravitational field, i.e., the functions  $g_{ik}$  to be removed, there does not remain a space of the type (I) [Minkowski Space], but absolutely nothing, and also no 'topological space'. For the functions  $g_{ik}$  describe not only the field, but at the same time also the topological and metrical structural properties of the manifold. ... There is no such thing as an empty space, i.e., a space without field. Space-time does not claim existence on its own, but only as a structural quality of the field."*

In passing, we note that in the conventional sense we can and do have many fields "in the same space", which is merely the statement that a net field has internal structure, and so does a net spacetime. Extending that notion, we can conclude that spacetime is in fact naught but a set of fields, both static and dynamic. The total energy density of all those fields at any point in space constitutes *a potential* with that energy density at that point, and with that internal field dynamics and structure. So because of its incredible field energy density, space is also *identically* a giant potential with internal structure and dynamics. With that observation, we rather casually join the seething vacuum of particle physics, the spacetime of general relativity, and the fields of electromagnetics as *different aspects of the same thing*. We point out that our concept of the supersystem therefore only identifies the three separate things into which this "one-thing" has been arbitrarily divided in much of physics.

Although he tried more than once, Einstein himself failed to achieve a successful unified theory of gravitation and electrodynamics. One thing he added in his earlier theory was a cosmological constant, which he felt was necessary to explain a stable closed universe. He later regretted that assumption, but today with the discovery of the acceleration of the expanding universe, which can only be caused by antigravity, his cosmological constant has assumed a new and vital role in the search for the source of this observed antigravity effect in the cosmos.

### **8.2.6 Kaluza-Klein 5-Dimensional Unified Theory**

Using five dimensions, a unified theory of general relativity and electrodynamics was advanced by Kaluza {508} as extended by Klein {509}. This is a notable extension of Einstein's theory, and a very substantial literature exists in the Kaluza-Klein area.

### 8.2.7 The Sachs Unified Field Extension of Einstein's Theory

Another notable extension of Einstein's theory, which does include electrodynamics and the results of quantum mechanics as well, is the theory by Sachs {510}. Starting with Einstein's general relativity view and the group symmetry of its underlying mathematics, Sachs extended Einstein's theory into a fundamental theory of matter in all domains. Einstein's group formalism and the spinor-quaternion calculus in a curved spacetime provide the genesis of matter fields. The theory encompasses globally covariant field equations for inertial features of matter including its force manifestations. Unification is provided by the generalized spinor formalism. Quoting a popularized summation {511}:

*"Novelfeatures ofgeneral relativity are shown to emerge, in elementaryparticle physics as well as astrophysics. Especially noteworthy ...is a factorization of Einstein's field equations to a quaternion field formalism which, by way of a single covariant field, includes both gravitation and electromagnetism coupled to matter field equations — whose linear (low energy) limit recovers quantum mechanics. The ...original approach also furnishes derivations, not previously available, of several observed properties of inertial mass and gravitational force. "*

For a more technical description of how the unification of electrodynamics with general relativity is derived, we quote directly from Sachs {512}:

*"It was demonstrated earlier that the factorization of Einstein's second-rank, symmetric tensor field equations, by removing the space and time-reflection elements from the underlying covariance group, yields a 16-component quaternion metrical field equation. The 16 equations were then re-expressed in a second-rank tensor form, breaking up into  $10 \oplus 6$  equations. The 10 equations are in one-to-one correspondence with Einstein's symmetric tensor equations for gravitation; they are even under reflections. The remaining 6 equations are in antisymmetric tensor form; they are odd under reflections. Taking the covariant divergence of the latter equations then puts them into one-to-one correspondence with the structure of Maxwell's equations for electromagnetism. What was shown earlier was that the four of Maxwell's equations with sources followed. What is shown in this paper is that the other four of Maxwell's equations that are source-free also*

*follow, thus indicating the absence of magnetic monopoles from this theory, as in the usual Maxwell formalism. This shows that the factorization of Einstein's field equations to the quaternion form fully unifies the gravitational and electromagnetic manifestations of interacting charged matter."*

To freely download several of Professor Sachs's important technical papers, one is referred to his website at <http://www.compukol.com/mendel/articles/articles.html>.

The  $O(3)$  electrodynamics of Evans and Vigier has been shown to be a special subset of Sachs's electrodynamics {513a}. Hence  $O(3)$  can be used to engineer much of the Sachs unified field theory phenomenology, including — in our view — both gravity and antigravity. The first theoretical indication of this has been published by the AIAS (Alpha Foundation's Institute for Advanced Study) {513b}. Shortly we discuss our own views on how to directly perform engineering of antigravity.

A great many excellent publications on general relativity and the background of scientific knowledge in gravity exist; e.g., the text by Wheeler *et al.* {514} is particularly good. Einstein himself wrote a book on his special and general theory for the nonspecialist {515}. A collection of English translations of some of the original papers on relativity is provided in a book by Einstein, Lorentz, Minkowski, and Weyl {516}. Many other gravitational theories or changes to major theories have also been proposed by other scientists, but are not discussed here. For our purposes, an abbreviated discussion will suffice to understand a fundamental approach to feasible antigravity.

Since we are interested in actual working systems, a short review of some of the efforts in asymmetric lifting and propulsion experiments is useful.

## 8.3 Selected Antigravity and Inertial Propulsion Research Efforts

We give only a small sampling of the many efforts performed or ongoing in this area over the last few decades, and some still ongoing today.

### 8.3.1 T. Townsend Brown

**Our** first example is the work of T. Townsend Brown. Brown was working on a "gravitor" before he finished high school, and continued work in electrogravitation throughout his life. Space is a dielectric, and Brown reasoned that the displacement current in a capacitor dielectric could



influence the space dielectric itself.<sup>216</sup> Hence he built, tested, and patented several variations of lifting devices based on this concept {517a-517e}. Essentially, he found that certain high capacitance dielectrics could be subjected to high voltage (50 to 300 kilovolts), and would exhibit thrust in the direction from the negative to the positive pole.

Here we point out our contention that all EM energy in space comes from the time domain via the negative charge, and re-enters the time domain via the positive charge. This is consistent with Brown's finding. Although he demonstrated many such lifting and thrusting devices, Brown was never able to obtain sufficient financial and scientific backing to bring a practical embodiment of his inventions into practice. His work, however, has been replicated by multiple experimenters, including NASA researchers (see below) and several researchers contributing results to Jean-Louis Naudin's website <http://jnaudin.free.fr/html/lifters.htm>.

### **8.3.2 Jonathan W. Campbell**

Recently a U.S. patent {518} on a thrusting capacitor, by Campbell, has been issued and assigned to the U.S. Government (NASA), and made available for commercial licensing. The patent write-up states that thrust from capacitors is well known, but has been too small to be practical. The patent purports to remedy that impracticality. A version of the NASA device has been replicated by the Naudin researchers also. So an adaptation of Brown's work has been patented by the U.S. government with intentions of licensing. This would appear to validate much of Brown's approach and efforts.

### **8.3.3 The Dean Drive**

Our second example is the inertial drive patented by Dean {519a-519e}. Unfortunately, the effects of the Dean drive later appeared to be a problem in accurate measurement. Nonetheless, work still continues along the direction shown by Dean. One may argue that mechanical materials also contain charges and have a certain kind of capacitance. Hence, mechanical motion of the parts of the machine does move these charges and dielectrics, opening a possibility of interacting with the dielectric of space. For example, Sweet's VTA involved a sustained self-oscillation between the local vacuum and the barium nuclei in his barium ferrite magnets.

<sup>216</sup> We have not yet explored the gravitational effects — if any — of our concept of the triode capacitor, discussed in paragraph 6.3.7 and diagrammed in Figure 6-17. We will examine it as soon as we have the proper equipment.

Dean's approach still has merit, even if a particular embodiment gave a negative result when very accurate measurement was performed. It is particularly of interest that mechanical force is essentially derived from electromagnetic forces (and fields) at basis. These base EM fields involve (and identically are) curvatures of spacetime, and hence the motions of the inertial drive mechanical apparatuses do involve at least some curvatures of spacetime and dynamic changes to them.

Our comment is that, when the additional but neglected Heaviside nondiverged energy flow component is accounted, these field interactions internal to matter can produce many orders of magnitude greater curvature of spacetime than is accounted by the diverted Poynting energy flow component only.

The "inertial antigravity" approach may be visualized as the use of excess gravitational thrust in a specific direction. If that direction is against the local pull of gravity, and is more powerful, then "lift against the gravitational pull" is obtained. Rigorously, this is not true antigravity but manipulated excess positive gravity.

In our approach to antigravity, one way to approach the problem is to have the mechanical apparatus also the source of an intense *negative energy EM field*, producing an intense flux of Dirac sea holes into and in the local surrounding spacetime. The excess charge removed from the Dirac holes can in fact be used in the electrical powering of the physical system, as was demonstrated in the Sweet VTA antigravity test. Then movements of the mechanical parts could involve movement of strong negative energy fields, hence strong curves of local spacetime that are local *strong negative gravityfields*. Or, better yet, movement of the charges themselves will also produce field-induced movement of the Dirac sea hole negative energy. This appears to be a practical method to manipulate the metric itself, along the lines proposed by Puthoff *et al.*<sup>217</sup>

### 8.3.4 Henry Wallace

Other work has been by Henry Wallace, an engineer working for General Electric in the 1970s. His work dealt with the interactions of relatively moving masses of various kinds, and it is described in his patents {520a, 520b}. The discussion under the Dean drive probably applies to Wallace's work as well.

<sup>217</sup> H. E. Puthoff, S. R. Little, and M. Ibson, "Engineering the Zero-Point Field and Polarizable Vacuum for Interstellar Flight," *J. British Interplanetary Soc.*, Vol. 55, 2002, p. 137-144.

### 8.3.5 J. F. Woodward

Next is the work of J. F. Woodward, resulting in one or more patents {521} and multiple articles in the legitimate physics literature {522a-522k}. Woodward uses an adapted theory based on Mach's principle and on the thesis that the mass of a capacitor can be made to vary from its normal mass by rapidly charging and discharging it — say, at a frequency of 20 kHz. This predicted effect is testable, although some sophistication in the testing is required.

Woodward's publications show the results of actual experiments, measuring a very small change in the mass, and are worthy of much further investigation. Here we note that the actual mechanism generating the inertia of an object is still an open issue, with several different contending theories.<sup>218</sup> Whether the gravitational mass and the inertial mass are identical or not, also remains an issue. If the exact local mechanism generating the inertia of a mass could be decisively found, then direct methods of changing the inertial mass and the gravitational mass might be a real possibility, and research to try to find such methods would be strongly indicated.

Our further comment is that the mechanism that generates mass itself has never been specified in formal physics,<sup>219</sup> particularly when one views an observable (such as mass) as continually recurring in 3-space rather than continuously existing in 3-space, due to the  $d/dt$  operator imposed on spacetime by the observation process. Before the reader assumes that mass is well understood, a reading of Jammer's scholarly work {523} is highly recommended.

From our viewpoint we stress that observed mass cannot continuously exist, but must be an effect and the instantaneous frozen output of the  $d/dt$  observation process invoked on an ongoing 4-space process. Hence, from this view there is indeed a "process" that (continually) creates mass — it is at least the emission of EM angular momentum (a photon) from the *masstime* entity. Similarly, there is a "process" that continually destroys or converts any mass — it is the absorption of a photon and conversion of the

<sup>218</sup> E.g., (a) A. Rueda and B. Haisch, "Inertia as reaction of the vacuum to accelerated motion," *Phys. Lett. A*, Vol. 240, 1998, p. 115-126; (b) B. Haisch, A. Rueda and Y. Dobyns, "Inertial Mass and the Quantum Vacuum Fields," *Ann. Phys.*, Vol. 10, 2001, p. 393-414.

<sup>219</sup> The present author made an early **and** crude attempt at doing it in his "Quiton-Perceptron Physics." 1973, NTIS Report AD-763-210.

mass  $m$  into masstime ( $m + dm)dt$ . Mass "flows through time" via this time charging and discharging, in the form  $m \Rightarrow mt \Rightarrow m \Rightarrow mt \Rightarrow m...$  etc.

Again we stress that masstime  $mt$  is not mass  $m$ , but is as different from it as impulse  $Ft$  is from force  $F$ . We crudely proposed such an initial mass-generating mechanism in 1973 {524a}, with additional information published in 1998 {525a}, which may have bearing on the mechanism involved in Woodward's experiments.

### 8.3.6 E. R. Laithwaite

Eric Laithwaite was for some years a professor with the Imperial College in London. He was one of the pioneers of the linear electric motor and of portions of the magnetic levitation (MagLev) train concept. An illustrious career headed for greater things (perhaps knighthood, Fellow of the Royal Society, etc.) was abruptly derailed in 1973 after he lectured to the prestigious Royal Institution by invitation and demonstrated that a heavy gyroscope, difficult to lift with one hand while not turning, could be lifted easily with that same hand, once turning at speed. Laithwaite's suggestion that Newton's laws of motion might be in difficulty proved much too controversial. The Royal Institution (apparently for the first time in its 200 year history) did not publish proceedings of that invited discourse.<sup>220</sup>

One of the remarkable things Laithwaite achieved was a form of "indefinite motion" device that he demonstrated circa 1970 {526}. The Centennial Centre of Science & Technology in Ontario was looking for working models to decorate the entrance hall. Laithwaite showed that if a linear-motor primary was rolled into a cylinder, so that it became simply the stator of a conventional induction motor,<sup>221</sup> a steel washer (about 3 cm. in diameter) could be made to roll continuously in a vertical plane around the inside of the stator. A combination of centrifugal force and magnetic

<sup>220</sup> With some humor we point out how shocking is our proposal that such a thing as "continuous" propagation of an object or energy through 3-space does not exist. Instead, small differential "pieces" of it continually "recur" at successive positions, much like the projection of the frames of a motion picture frame, where continual observation is the "projection process". Nonetheless, in our proposed solution to the source charge problem, either that is true or every charge in the universe is a perpetual motion machine, freely creating energy out of nothing. In our view, that is the impact of the long-neglected source charge problem in quantal and classical electrodynamics. It has produced the wrong and naive notion of what "propagation through space" actually entails.

<sup>221</sup> Something similar to diagrammatic Figure 6-26 in Chapter 6.

attraction kept the washer in contact with the stator at all times. At the same time, a pivoted copper cylinder could be held in the center of the stator and would be seen to rotate on its own axis in the opposite direction.<sup>222</sup> Laithwaite completed and delivered a working model to the Centennial Center of Science & Technology. The reader should note the similarity of Laithwaite's proven experimental device to the magnetic Wankel engine.

In addition to his attention to Heaviside's unpublished draft notes and manuscript on a combined theory of electromagnetics and gravity (previously discussed above) {502}, Laithwaite spent the latter years of his life working on sophisticated gyroscopic systems {527a-527h}. Ultimately he felt he had successfully produced a mass transfer effect {528} and the basis for a propulsion system. He and William Dawson applied for a patent in 1993, which was granted in 1995 {529}, with a U.S. patent granted in 1999 {530}. Regretfully, Professor Laithwaite died in 1997.

### 8.3.7 Floyd Sweet's Vacuum Triode Amplifier (VTA)

See again Chapter 6 and Figures 6-5 through 6-14 on the work of Floyd Sweet, previously discussed in paragraph 6.3.2. My concept of antigravitation used in the experiment is shown in Figure 6-15. By now, the sharp-eyed reader will recognize that my method actually constitutes a conceptual extension and definitization of the Dirac electron theory, reinterpreted to recover negative mass, negative energy, negative energy fields, and negative energy potentials. The defining feature is the deliberate use of a COP»1.0 main power system (perhaps constituting the power system of a flight vehicle) as a source of locally strong negative energy EM fields generated by the concentrated Dirac sea holes (causal 4-positrons being negative energy 4-electrons prior to observation) locally produced in the power system. We collaborated with Sweet on the vacuum triode amplifier for more than a decade, and in fact suggested the name of the device.

The antigravity approach designed by the present author was based on realizing that negative energy sources (e.g., 4-positrons as negative mass 4-electrons prior to their reaction and observation) produce *negative*

<sup>222</sup> We have had the distinct notion that the fundamental *contrarotating* mechanism found by Laithwaite is probably an analogous mechanism — or very similar — to the mechanism utilized by Bauman in his Swiss converter (Methernitha device). As pointed out, it also has remarkable similarities to the magnetic Wankel engine, except that the magnetic Wankel does not utilize two contrarotations.

*energy* EM fields. The field can reach out over all space, so a negative EM energy field represents a reversed curvature of a large volume of spacetime. Hence it represents a considerable antigravity field — particularly when one considers the unaccounted huge Heaviside component of the negative energy field and charge interaction. Since the field strength falls off as the inverse square of the distance from its source, the strong antigravity effects of negative energy EM fields are much stronger locally than at a distance. This is particularly true when the conventionally ignored Heaviside nondiverged EM energy flow accompanying the accounted diverged Poynting energy flow of every field-charge reaction is accounted. This usually ignored factor dramatically increases the antigravity intensity produced by the local negative EM energy field by many orders of magnitude, often by nearly  $10^{13}$ .

My antigravity concept (then and now) is shown in Figure 6-15 of Chapter 6. At the time, the only available device I knew of that produced a substantial percentage of output negative EM energy was Sweet's vacuum triode amplifier. So I persuaded Sweet to fabricate a new output section (an output load similar to Figure 6.8 but containing ten sockets for ten 100 watt lamps). Thus the output of the unit — which adjusted automatically to the available load — could be increased in 100-watt increments by merely screwing in the lamps one at a time and making laboratory readings after each new 100-watt load increase was added. This was done and the concept was successfully tested by Sweet {531}, who was making the measurements in California and reading them off over the phone to me (I was in Huntsville, Alabama). The experiment worked beautifully.

The setup and progress of the experiment were intended to materially increase the strength of the *negative energy* EM field and Dirac sea hole flux already produced to a lesser extent by the Sweet vacuum triode amplifier (VTA) in its normal operation. Thus the hypothesized negative energy antigravity field, produced weakly by the negative energy from the device in its ordinary power output range of 500 watts, was to be substantially increased at 1,000 watts. The response to the net gravitational field surrounding the object would thus be the resultant of two factors: (i) the normal response of the device's positive mass to the positive gravitational field of the Earth etc., and (ii) the additional response of the device's positive mass to the local antigravitational field produced around it. The measurable result was expected to be a decrease in the measured weight of the object on the laboratory bench.

As discussed, this stratagem succeeded dramatically. The weight of the vacuum triode amplifier was decreased, smoothly and controllably, by

90% on the laboratory bench (see again Figure 6-9).<sup>223</sup> The results were later published in a joint paper {531} prepared by the present author. I placed Sweet's name first on the paper because he was the inventor of the VTA, which demonstrated the effect once properly modified as I requested. Note that the extra antigravitational field effect on an object is indeed a local effect, which the experiment also showed. This effect was obtained at a COP>1,500,000 (actually, at nearly a COP = 3,000,000) and at ELF frequency.

The ELF frequency is important. As we explained previously, the highest energy photons of all are the lowest frequency photons, when the highly compressed time-energy component of the photon is accounted as well as the decompressed spatial energy component. Hence, for very appreciable local curvature of spacetime to produce considerable antigravity, the antigravity source must produce negative energy fields consisting of negative energy photons at low frequencies (such as 60 Hz). Else, the curvature of spacetime is so small that little effect will evidence. My best "back of the envelope" estimate of the efficiency of the antigravity process in the VTA was 10%.

### 8.3.8 Ning Li and (separately) E. Podkletnov

Very interesting work was performed by Ning Li {532a-532d}, a scientist originally with the University of Alabama in Huntsville (UAH), who returned to China for a while but is now back in Huntsville. Quoting David Brown from the UAH website from 1997:

*"In 1989, Dr. Ning Li of UAH predicted that if a time varying magnetic field were applied to a superconductor, charged and deformed lattice ions within the conductor could absorb enormous amounts of energy via the*

<sup>223</sup> Many times I have been asked how such small output power increase (from 500 to 1,000 watts) could possibly achieve such dramatic antigravity results. The answer - due to the neglected Heaviside nondiverged energy flow component — lies in multiplying the power output by the "Heaviside energy amplification factor  $k$ " where  $k$  may be as large as  $10^{13}$ . A 500-watt accounted increase, multiplied by  $10^{13}$ , is actually an incredible increase in the total EM negative energy field density being created in the local vacuum. In short, a very little "accounted" power increase of the COP»1.0 VTA output is actually a very vast negative power output increase when the long neglected k-factor is accounted. It is just this missing k-factor and the failure to account for the negative energy KM fields generated in COP»1.0 discharges in violent astronomical phenomena that seem to be responsible for generating the excess antigravity that is accelerating the expansion of the universe.

*magnetic moment effect. This acquired energy would cause the lattice ions to spin rapidly about their equilibrium positions and create a miniscule gravitational field. Dr. Li's calculations showed that if these charged, rotating, lattice ions were aligned with each other by a strong magnetic field, the resulting change in local gravity would be measurable. "*

*"Podkletnov and Nieminen (1992) {533} made the accidental discovery that a single-phase, dense, bulk, high  $T_c$ , superconducting, ceramic disk spinning at 5,000 rpm can produce a 2 percent reduction in the weight of non-conducting, non-magnetic objects placed over the spinning disk. UAH and MSFC [Marshall Space Flight Center, apart of NASA] [cooperated] on a joint research project to independently confirm the results of the Podkletnov experiment and to validate Dr. Li's theory of gravity modification via superconductor. On March 26th, 1997, as a part of this project, the joint UAH-MSFC research team produced the largest high temperature superconducting disk ever manufactured in the USA. This disk measures 12 inches in diameter and is 0.5 inches thick "*

We now explain the experiments, from our point of view of the mechanism for antigravity. We remark that, at least in theory, the charges in such a rotating superconducting disk have an inward "discharge" acceleration force that is a function of the distance of the charge from the rotation axis center. Hence, in the rotating frame, some of these charges are very strongly "accelerating" toward the center, as are their spins whose magnetic vector is orthogonal to the E-field vector. A flow of EM energy exists perpendicular to the rotating flat disk and is accelerating at right angles to the disk surface. This is analogous to a *discharge* (sudden acceleration) phenomenon, and it will also produce accelerating negative energy Dirac sea 4-holes in the vacuum component of the supersystem of the spinning disk. So from the spinning disk there is a sort of "wide beam" of Dirac sea 4-hole current in the vacuum, radiating at right angles to the disk surface, with heavier concentrations toward the outside of the disk. The result is that objects in the Earth's gravitational field, and also placed in the path of this negative energy Dirac sea 4-hole current, is acted upon by two superposed curvatures of local spacetime: (1) the positive curvature due to the Earth's gravitational field, and (2) the negative curvature due to



the negative energy field's curving local spacetime. The total net gravitational effect will be due to the algebraic sum of the superposed two spacetime curvatures — the normal positive curvature from the Earth's gravitational field and the second a negative curvature created by the Dirac sea hole current's negative energy fields (Heaviside energy flow component considered). The expectation is therefore a *reduction* in the weight of the object, as is shown in the experiments.

The UAH-MSFC group was unable to confirm Podkletnov's findings.<sup>224</sup> Ning Li and the NASA group later split amicably. Ning Li continued her theoretical work, eventually ceased publishing papers for a period to protect the techniques and experimental results achieved in her work, and focused upon potential applications. She apparently returned to China for some time, but is now back in Huntsville, Alabama and still experimenting. We suspect there may also be a Chinese research effort into antigravity, using the approach taken by Ning Li. Perhaps information from that program will be released in the future.

But what of the work of Podkletnov since his original experiments? NASA continued to try to replicate his disk and his work, with Podkletnov acting as a consultant. Presently, NASA has paid an independent research firm to replicate the disk to full specifications, which has just been accomplished as this is written. At this writing, the experimental results of this new attempt are not yet available as the work is still in progress. It should be available by the time this book is published.

Meanwhile, a relatively new paper by Podkletnov and Modanese has been published on the Los Alamos National Laboratory website.<sup>225</sup> This method uses high amperage sharp pulse discharges from a superconducting ceramic electrode, to produce an anomalous radiation in a focused beam. Significantly, the beam does not noticeably attenuate through different materials. The beam exerts a short repulsive force on small movable objects on the propagation axis, with the force proportional to the mass of the objects.

<sup>224</sup> E. Podkletnov and R. Nieminen, "A possibility of gravitational force shielding by bulk  $\text{YBa}_2\text{Cu}_3\text{O}_{7-x}$  superconductor," *Physica C*, Vol. 203, 1992, p. 441-444.

<sup>225</sup> Evgeny Podkletnov and Giovanni Modanese, "Impulse Gravity Generator Based on Charged  $\text{YBa}_2\text{Cu}_1\text{O}_{7-y}$  Superconductor with Composite Crystal Structure," carried on website <http://xxx.lanl.gov/abs/physics/0108005>.

We interpret the results as completely consistent with our own proposed excess gravity and antigravity mechanism. We know that such sharp discharges produce significant Dirac sea 4-hole currents in the local vacuum component of the supersystem. Such currents in a beam interact very little with intervening materials, and the major spacetime curvature effects are concentrated upon the propagation axis. On that axis, force effects can be expected upon small independent objects, due to the *additional* negative curvature added to the local spacetime in their supersystem. The impulse produced on the object should indeed be proportional to the mass of the object and independent of its composition, since it is a gravitational force effect induced by local curved spacetime. The force should be repulsive in the beam, since that is the direction of the antigravity force that will be induced in objects in the axis of the beam, by the beam of negative energy Dirac 4-holes. A positive gravity force would mean attraction between the object in the propagation path and the source of the beam. A negative gravity force would therefore mean repulsion.

So Podkletnov and other scientists are still working on a successful effect. It will be interesting to see what results are reported in the future, and whether they will deviate from their present attempt to explain the effect by a combined quantum gravity and anomalous vacuum fluctuations approach.

### **8.3.9 NASA's Breakthrough Propulsion Physics (BPP) Project**

NASA's Breakthrough Propulsion Physics Project was established in 1996. It seeks a breakthrough in space transportation involving "(i) propulsion that requires no propellant mass, (ii) propulsion that attains the maximum transit speeds physically possible, and (iii) breakthrough methods of energy production to power such devices." Investigations involve coupling of gravity and electromagnetism, the quantum vacuum, hyperfast travel, and superluminal quantum effects. The project is managed by the Glenn Research Center, sponsored by the Advanced Space Transportation Program, with overall management by NASA Marshall Space Flight Center, Huntsville, Alabama.

NASA continues its investigations and experiments in methods to change **the** force of gravitational attraction. The scientist in charge of the project is David Noever of the Marshall Space Flight Center. The work is still considered a work in progress, with the need for both experimental investigation and meticulous design of experiments, instrumentation, and measurement techniques.

The overall NASA program also spreads to other supporting laboratories and projects. For example, at the Jet Propulsion Laboratory (JPL) Kulikov {534} has measured the difference between inertial and gravitational mass of a boson in a heat bath. At least one invention seems to have resulted or to be in progress, assigned to JPL.

As mentioned, the U.S. Patent by Campbell {518} on a capacitor device producing a net thrust force (a more modern version of T. Townsend Brown's work) has been issued and assigned to NASA.

### 8.3.10 Scientific Conferences

There are regular conferences (several per year) being held in the U.S. and elsewhere, dealing with antigravity and electrogravitic propulsion. We give a little-noticed but pertinent example: In a nice presentation in 2001, LaPointe {535} proposed a new method for producing anti-matter. Currently antimatter production is accomplished in very large accelerators, and is therefore quite expensive. For increased experiments, a cheaper and much smaller (and much more available) process is highly desirable.

In the Klein paradox, which involves very large potential drop across a very short distance — less than the Compton wavelength of the antimatter particle — matter and anti-matter pairs are produced. LaPointe hypothesized that it may be possible to use the Casimir effect to push one side of the step into the negative energy range. He is at least *thinking toward* negative EM energy sources that produce negative EM fields and negative gravity in the surrounding space, without explicitly enunciating it in that fashion.

We already briefly discussed our own approach to antigravity, which is a much simpler and cheaper anti-particle producing mechanism, as demonstrated by the Sweet device. In short, overunity EM systems with  $COP \gg 1.0$  do produce free flows of causal (before observed) 4-positrons (still in negative energy 4-electron state prior to interaction) in local spacetime immediately surrounding the system. Consequently, LaPointe's efforts are in what we believe to be the correct direction, but he is still using a very difficult mechanism to engender the antimatter production. Also, the positrons or other antimatter sources of the negative energy fields must remain in the causal (unobserved and non-interacted) 4-state, in order to produce negative energy EM fields and potentials and antigravity.

### 8.3.11 James Corum *et al.*: Rectified Slepian AC Force Resonator

Another example is some promising work by Corum *et al.* {536}. We quote from the abstract and summary of his paper:

*"Corum presented an experimental paper on the use of the Heaviside force in conjunction with a Slepian antenna as a form of space drive using nothing more than the classical Maxwell stress tensor. Slepian proposed the same thing in 1949, but came to the conclusion that it would not be useful, since the time average of the resultant AC force would be zero. Corum's contribution has thus far been two-fold: (1) In conjunction with Dr. Alan Barnes of WVU he has experimentally shown that the AC version of the Slepian Resonating Antenna does produce a force, and has measured it to within 3.6%, and (2) has designed a way for Hartley's variable capacitor rectification to be used with the Slepian resonator such that the rectification results in a DC force component. The first experiment has already been achieved, the second experiment is the logical next step. If successful, the result would be quite revolutionary: a true space drive."*

Our comment is that this unilateral thrust force work is important. In our view, the Heaviside energy flow component does not appear in Slepian's vector  $\mathbf{j}\phi$ , which contains only the diverged EM energy flow surrounding a circuit or component, but it is present immediately outside the circuit where the Slepian vector exists. Hence there is an enormous, extra energy flow closely associated with every EM circuit, that is unaccounted since Lorentz's closed surface integration of the energy flow vector discarded it quite arbitrarily.

We already know from the Bohren experiment (and thousands of others similar to it) previously cited that resonant charges do collect excess EM energy from a given EM energy flow input, compared to the collection from that flow by the same charges in nonresonant state. In using the Slepian resonator and then rectifying its output, it would appear that both the diverged (Poynting) energy flow component and the Heaviside nondiverged energy flow component are first resonated and then rectified. In addition, excess energy is collected — much more than is in the normal "static charge" formula assumptions for Poynting energy flow and in assuming only a "single pass, single interception and collection" of the energy.

An important factor then is obvious: Once the energy flow is surrounding the circuit, there exists a certain local curvature of the immediate external spacetime. The rectification represents not only a change in the Slepian

vector current in the circuit, but also a change in this local ST curvature interaction upon the circuit matter and charges. In short, it should produce a DC component in the direct excess interaction of the rectified local curvature of spacetime. This should produce *excess direct propulsive force*, just as Corum theorizes and the experiments support to date.

Further, the oscillation of the large, *unaccounted* Heaviside nondiverged energy flow component involves the oscillation of a "dark energy" component that may be orders of magnitude greater than the *accounted* Poynting component's magnitude. By involving this huge energy flow component in oscillation and synchronized to the resonant Slepian circuit, Corum has unwittingly involved the supersystem as a COP»1.0 EM "energy converter" system. Hence, there is appreciable Dirac hole current (in causal 4-form) in the local vacuum, not reacted with the materials in the system and therefore not converted to material lattice holes attached to positive mass. The time rate of changes of the negative energy fields and potentials are thus significant for antigravity effects, in the approach taken by the present author. In short, we believe Corum *et al.* are in fact producing significant evidence for a workable approach to unilateral thrust force.

This work by Corum *et al.* thus is highly promising, is solidly based experimentally, and certainly bears watching closely. We would strongly suggest that Corum *et al.* analyze their proposed mechanisms and results obtained in terms of supersystem analysis rather than system analysis, using higher group symmetry electrodynamics, and recover and include the long-neglected Heaviside energy flow component.

### 8.3.12 Gravitec, Inc. and H. Serrano

A patent {537} was issued to H. Serrano on Oct. 5, 2000 and assigned to Gravitec, Inc. whose principal investigator and corporate officer is Tim Ventura. Based on this invention, Gravitec, Inc. has developed and demonstrated a rotary device that develops unilateral thrust. Purdue University began a small but steady effort to test the unit, first in the atmosphere and later under high vacuum conditions. The first tests have been successful, and a paper {538} from the Purdue study shows it is not the ion wind effect, which is orders of magnitude too small to account for the demonstrated thrust. Further, Jean-Louis Naudin has replicated and tested the Serrano thruster, and it works beautifully {539}. Ventura also hopes to develop a toy kit, with safe power supply, which would allow persons to perform their own successful lifter experiments and perhaps rotary experiments at nominal cost.

### 8.3.13 Transdimensional Technologies, Inc.

There is also ongoing important propulsion work at Transdimensional Technologies, Inc. of Huntsville, Alabama {540}. Founded in 2000 by its chief scientist, Jeffrey Cameron, the company has developed several novel propulsion and lifting mechanisms. Independent tests of some of these systems have been accomplished by Jean-Louis Naudin, and the results can be seen on his website (previously cited).

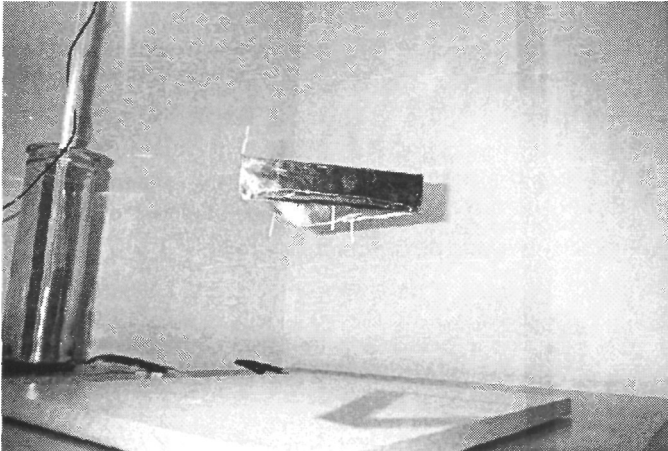

Figure 8-1 Naudin's replica of the Transdimensional Technologies lifter.

As we go to press, Transdimensional's most recent propulsion effect is called Power3 (power "cubed"). It uses an asymmetric capacitor to

produce the thrust in space, and the principle has been successfully tested in a vacuum. A larger, triangular lifter made mostly of pipe was demonstrated in vacuo to NASA officials in Huntsville, Alabama. Cameron has patents pending on magnetocaloric hybrid rocket engines and asymmetric gravitational waves {541}. A replica of the Transdimensional lifter successfully tested by Naudin is shown in Figure 8-1, by courtesy of Jean-Louis Naudin. Naudin's replica of the Transdimensional Technologies rotational device is shown in Figure 8-2.

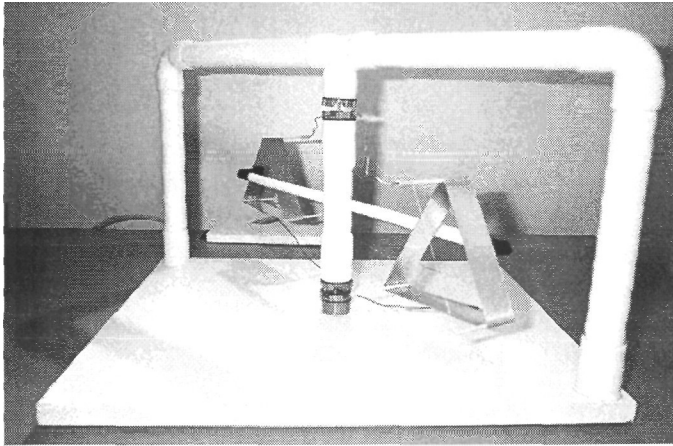

Figure 8-2 Naudin's replica of the Transdimensional Technologies rotational device.

We understand that new Transdimensional Technologies systems, now in patent process and still closely held, represent dramatic advances in the state of the art. The corporation foresees eventual commercial licensing of some of its developments, and the development of practical lift vehicles and space propulsion systems within 3 to 5 years.<sup>226</sup>

<sup>226</sup> Ken Moore and I personally visited Transdimensional Technologies here in Huntsville, and we found a very straightforward, enthusiastic, and hard-working group. We were treated with great courtesy, so much so that Jeff Cameron graciously cut short his vacation day and came in to show us the lab equipment and give a demonstration. We very much appreciate the work that Transdimensional Technologies is doing, and we certainly wish this fine group outstanding success in their efforts. We also are very appreciative for their courtesy and consideration in showing us the demonstrations and for their cogent discussions with us, which were most helpful.

### **8.3.14 American Antigravity (Tim Ventura's Company)**

Tim Ventura is a very energetic lifter and antigravity researcher, who has done work independently and for others such as Transdimensional Technologies. The results of his many experiments and replications, tests, photos, etc. are on his website at <http://www.americanantigravity.com>. He also has several videos showing his testing, as well as detailed instructions for a researcher to build his own demonstration unit and verify the tests. Tim kindly furnished some needed information in this area, and put me in touch with other researchers and websites, which I appreciate.

### **8.3.15 Jean-Louis Naudin**

Jean-Louis Naudin is a tireless researcher in the fields of COP>1.0 systems and processes, and in the field of lifters, inertial thrusters, and possible antigravity systems. His website is a cornucopia of information, patent references, inventions, processes, and replications or replication attempts by Jean-Louis and others who regularly work on such things and communicate with him. The website is <http://jnaudin.free.fr/>. From there, one may click on the various parts of the site and on the links to other sites to gain a wealth of information on these subjects.

His lifter work, including successful replications and instructions on how to build lifters, can be accessed from <http://jnaudin.free.fr/html/lifters.htm>, and will keep the interested researcher busy for many productive hours. We especially commend Jean-Louis for his extraordinarily important efforts and for making all this work available to researchers worldwide. Once on the site, one is free to choose from a very wide variety of projects, subjects, etc. The information value of this site is very, very high. We consider Naudin's site to be the single best information site on the web for COP>1.0 system information and for the new space propulsion methodology and effort. Necessary links to other related sites of interest are also provided.

Good hunting!

### **8.3.16 Other Research Work and Inventions**

While we have given a sort of quick overview of work done in this field, there have been many other patents filed by numerous inventors and additional work done by them. This is a dynamic field and it is moving; the biggest problem is that it is still sorely hampered by highly limited funding and an attitude by much of the scientific community that "if it has not been invented here, it doesn't exist".



In the table in Figure 8-3 below, we list some of the pertinent patent numbers for reference, with the emphasis on U.S. Patents. The Naudin website previously referenced has a great deal of information on these thrusters and lifters, including instructions for building and testing several of the simpler proof-of-principle versions. There are links to other sites with even more information. Naudin also includes the results of his successful replication and testing of a variety of these devices and inventions, as well as the successful replication by other experimenters. Naudin also gives construction instructions and information on some of these, so that independent researchers can build test units and test them if desired.

For those researchers interested in pursuing this area further, we would heartily recommend a determined search on the Internet, using Google ([www.google.com](http://www.google.com)) as their search engine. A good place to start is Jean-Louis Naudin's web site, and then run the cross-links. The combination will turn up quite an amount of specific material, from which the individual researcher can choose which approach and experimental method he wishes to pursue.

Figure 8-3.

### Selected Inertial Propulsion System Patents

T. Townsend Brown, "A Method of and an Apparatus or Machine for producing Force or Motion, British Patent 300,311, Nov. 15, 1928.

Norman L. Dean, "System for Converting Rotary Motion into Unidirectional Motion," USP #2,886,976, May 19, 1959.

T. Townsend Brown, "Electrokinetic Apparatus," USP #2,949,550, Aug. 16, 1960.

T. Townsend Brown, "Electrokinetic Transducer," USP #3,018,394, Jan. 23, 1962.

T. Townsend Brown, "Electrokinetic Generator," USP #3,022,430, Feb. 20, 1962.

T. Townsend Brown, "Electrokinetic Apparatus," USP #3,187,206, Jun. 1, 1965.

Henry Wallace, "Method and Apparatus for Generating a Secondary Gravitational Force Field," USP #3,626,605, Dec. 14, 1971.

Henry Wallace, "Method and Apparatus for Generating a Dynamic Force," USP #3,626,606, Dec. 14, 1971.

Fernand Estrade, "Device for Transforming Kinetic Energy," USP #3,807,244, Apr. 30, 1974.

Leo J. Novak, "Centrifugal Mechanical Device," USP #3,810,394, May 14, 1974.

Everett H. Benson, "Inertia Engine," USP #3,863,510, Feb. 4, 1975.

Oscar Mast, "Propulsion System," USP #3,889,543, Jun. 17, 1975.

Arthur N. Lehberger, "Centrifugal Propulsion Drive and Steering Mechanism," USP #3,897,692, Aug. 5, 1975.

Howard A. Gaberson, "Vibratory Locomotion Means," USP #3,916,704, Nov. 4, 1975.

Calvin I. Cuff, "Device for Converting Rotary Motion Into a Unidirectional Linear Motion," USP #3,968,700, Jul. 13, 1976.

Nicholas Joseph Schnur, "Method and Apparatus for Propelling an Object by an Unbalanced Centrifugal Force with Continuous Motion," USP #3,979,961, Sep. 14, 1976.

Calvin I. Cuff, "Device for Converting Rotary Motion Into a Unidirectional Linear Motion," USP #3,998,107, Dec. 21, 1976.

George Knap, "Orbital Propulsion Apparatus," USP #4,087,064, May 2, 1978.

Calvin I. Cuff, "Device for Converting Rotary Motion into Unidirectional Motion," USP #4,095,460, Jun. 20, 1978.

Robert L. Cook, "Device for Conversion of Centrifugal Force to Linear Force and Motion," USP #4,238,968, Dec. 16, 1980.

Ladislaw G. Srogi, "Mechanical Propulsion System," USP #4,242,918, Jan. 6, 1981.

Harry S. Melnick, "Unidirectional Force Generator," USP #4,261,212, Apr. 14, 1981.

- Frederick L. Dehen, "Apparatus for Converting Rotary Motion to a Rectilinear Force," USP #4,347,752, Sep. 7, 1982.
- Harry S. Melnick, "Mechanical Power Transmitting System," USP #4,398,431, Aug. 16, 1983.
- Peter Kleber, "Apparatus for Acceleration-Free Mounting of a Body in a Spacecraft," USP #4,408,740, Oct. 11, 1983.
- Fred de Weaver, III, "Propulsion System," USP #4,409,856, Oct. 18, 1983.
- Ronald K. Linde, "Centrifugal Reaction Chamber," USP #4,450,141, May 22, 1984.
- Fred de Weaver, III, "Propulsion System," USP #4,479,396, Oct. 30, 1984.
- Joseph Colla, "Mechanical Propulsion System," USP #4,577,520, Mar. 25, 1986.
- Elmer M. Dobos, "Propulsion Apparatus," USP #4,579,011, Apr. 1, 1986.
- Brandson R. Thomson, "Apparatus for Developing a Propulsion Force," USP #4,631,971, Dec. 30, 1986.
- James E. Cox, "Dipolar Force Field Propulsion System," USP #4,663,932, May 12, 1987.
- Alvin C. Peppiatt and Alfred J. Peppiatt, "Impulse Drive," USP #4,674,583, Jun. 23, 1987.
- Henry North, "Apparatus for Producing a Force," USP #4,712,439, Dec. 15, 1987.
- Harry S. Melnick, "Continuous Force and Impact Generator," USP #4,726,241, Feb. 23, 1988.
- Oscar F. A. Peterson, "Apparatus for Producing a Directional Unit Force," USP #4,744,259, May 17, 1988.
- James D. Mundo, "Universal Propulsion Powerplant and Impulse Drive Unit for Self-Propelled Vehicles," USP #4,770,063, Sep. 13, 1988.
- Lancelot I. Kethley, "Gyroscopic Propulsion Device," USP #4,784,006, Nov. 15, 1988.
- Charles Fulop, "Flywheel," USP #4,788,882, Dec. 6, 1988.**

- Charles E. Rogers and Fred Van Arsdell, "System for Propulsion and Positioning of a Transitory Object," USP #4,801,111, Jan. 31, 1989.
- Paul J. Montalbano, "Conversion of Rotational Output to Linear Force," USP #4,856,358, Aug. 15, 1989.
- George J. Zachystal, "Device for Obtaining a Directional Centrifugal Force," USP #4,884,465, Dec. 5, 1989.
- James E. Cox, "Dipole Accelerating Means and Method," USP #4,891,600, Jan. 2, 1990.
- Hector Serrano, "Propulsion Device and Method Employing Electric Fields for Producing Thrust," WO 00/58623, Oct. 27, 2000.
- Brian C. Motts, "Airship," USP #4,967,983, Nov. 6, 1990.
- Lyle M. Mason, "Centripetal Device for Concentrating Centrifugal Force," USP #4,991,453, Feb. 12, 1991.
- Alexander D. Kidd, "Gyroscopic Apparatus," USP #5,024,112, Jun. 18, 1991.
- Paul J. Montalbano, "Conversion of Rotational Output to Linear Force — a Transmission," USP #4,042,313, Aug. 27, 1991.
- Andrew T. Rodgers, "Controllable Gyroscopic Propulsion Apparatus," USP #5,054,331, Oct. 8, 1991.
- Mortimer S. Delroy, "Gyrostat Propulsion System," USP #5,090,260, Feb. 25, 1992.
- Kemal Butka, "Propulsion System," USP #5,111,087, May 5, 1992.
- Rex L. Schlicher, Steven M. Rinaldi, David J. Hall, Peter M. Ranon, and Charles E. Davis, "Nonlinear Electromagnetic Propulsion System and Method," USP #5,142,861, Sep. 1, 1992.
- Thomas L. Navarro and James D. Isaacson, "Apparatus with Rotatably-Driven Asymmetrically-Accelerated Eccentric Mass for Generating Translational Force," USP #5,150,626, Sep. 29, 1992.

Theodore R. Bristow, Jr., "Method and Apparatus for Converting Rotary Motion to Lineal Motion," USP #5,156,058, Oct. 20, 1992.

John C. McMahon, "Energy Transfer Device," USP #5,167,163, Dec. 1, 1992.

James W. Black, "Non-Linear Propulsion and Energy Conversion System," USP #5,182,958, Feb. 2, 1993.

James R. Taylor, "Electromagnetic Energy Propulsion System," USP #5,197,279, Mar. 30, 1993.

Michael J. Sohnly, "Magnetohydrodynamic Propulsion System," USP #5,211,006, May 18, 1993.

Ross C. Wood, "Stabilization System for a Freely Rotatable Platform," USP #5,256,942, Oct. 26, 1993.

James F. Woodward, "Method for Transiently Altering the Mass of Objects to Facilitate Their Transport or Change Their Stationary Apparent Weights," USP #5,280,864, Jan. 25, 1994.

Robert C. Willis, "Spaceship Propulsion by Momentum Transfer," USP #5,305,974, Apr. 26, 1994.

Harold L. Hull and Donald E. Joslin, "Reusable Mass Propulsion System," USP #5,313,851, May 24, 1994.

Kemal Butka, "Propulsion System," USP #5,334,060, Aug. 2, 1994.

James Harvey, "Impulse Converter," USP #5,335,561, Aug. 9, 1994.

Maurice Mitchell, "Net Kinetic Energy Differential Guidance and Propulsion System for Satellites and Space Vehicles," USP #5,377,936, Jan. 3, 1995.

Howard M. Woltering, "Rotating Eccentric Weights Vibrator System," USP #5,388,469, Feb. 14, 1995.

Richard O. Marsh, Jr., "Centrifugal Force Drive Machine," USP #5,388,470, Feb. 14, 1995.

Kemal Butka, "Propulsion System," USP #5,410,198, Apr. 25, 1995.

Thomas L. Navarro, "System for Generating Controllable Reference Environment and Steerable Translational Force

from Interaction Therewith," USP #5,473,957, Dec. 12, 1995.

Richard L. Lieurance, "Centrifugal Inertia Drive," USP #5,488,877, Feb. 6, 1996.

John C. Claxton, "Centripetally Impelled Vehicle," USP #5,557,988, Sep. 24, 1996.

Ezra Shimshi, "Apparatus for Energy Transformation and Conservation," USP #5,673,872, Oct. 7, 1997.

Richard E. Foster, Sr., "Inertial Propulsion Plus/Device and Engine," USP #5,685,196, Nov. 11, 1997.

James D. Booden, "Electromagnetically Actuated Thrust Generator," USP #5,782,134, Jul. 21, 1998.

George J. Howard, "Propulsion System," USP #5,791,188, Aug. 11, 1998.

Timothy J. Stoppelcamp, "Boot Strap Propulsion System," USP #5,831,354, Nov. 3, 1998.

Eric Laithwaite and William Dawson, "Propulsion System," USP #5,860,317, Jan. 19, 1999.

Jonathan W. Campbell, "Apparatus and Method for Generating Thrust Using a Two Dimensional, Asymmetrical Capacitor Module," U. S. Patent # 6,317,310 B1, Nov. 13, 2001. Assigned to U.S. Government.

### **8.3.17 Mechanism for the Antigravity Accelerating the Universe's Expansion**

Finally, in addition to sorely needed better means of space propulsion, one of the real incentives for antigravity research is provided by the search for a source of the now-established mysterious antigravity that is accelerating the expansion of the universe. Elsewhere in this book we have advanced our own proposal for the mechanism generating that *antigravity* effect in the cosmos.

Simply put, a very violent astronomical process may be considered a giant and very violent discharge phenomena, since it first involves a giant excitation followed by a giant release (discharge) of that excitation. All such phenomena involve strong broken symmetry during the discharge itself, with the concomitant strong available of causal 4-sources of negative energy and negative energy fields. These processes — in their causal unobserved state - do produce locally strong negative energy EM

fields from the source causal 4-positrons (Dirac sea holes prior to observation as positive mass 3-space positrons having positive energy and reverse-oriented). When the unaccounted and very large Heaviside nondiverged EM energy flow component accompanying every field and particle interaction is accounted, the causal negative "mass-energy" states produce strong antigravity fields, particularly considering the *lower frequencies* of many of the phenomena.

With the long-neglected Heaviside nondiverged energy component considered and not just the accounted Poynting diverged component, the total amount of negative EM field energy available in these violent process is dramatic. Accordingly, just as was the Sweet VTA in its increased power and its ELF pulsations, these giant astronomical sources are also giant negative "mass-energy" sources and strong antigravity sources as well. In short, such astronomical sources produce strong antigravity components repelling each other across the universe. Hence the observed acceleration of the expanding universe; the violent astronomical phenomena are continually "pulsing" the universe with antigravity and hence continually accelerating its expansion velocity.

In 2000, we also published a proposed mechanism for the source of the excess *positive* gravity holding the arms of the spiral galaxies intact {542}.

## 8.4 The Author's Engineering Approach to Local Antigravity

See again our discussion under Newton, subparagraph 8.2.1 above, and our discussion of a negative field energy extension to it. For a major laboratory, we believe that antigravity is straightforward,<sup>227</sup> if one first produces a COP»1.0 situation in a higher group symmetry electrodynamics process. This provides a very strong "displacement current" of causal 4-positrons (before parity inversion, time-reversal, etc.) as true negative energy "particles" or "states" or "Dirac holes" in the surrounding 4-vacuum. The actual "negative mass-energy field" is very large, due to the unaccounted Heaviside nondiverged negative energy component. Consequently, a substantial antigravity field is established.

<sup>227</sup> However, this is based on the assumption that the lab team first gives up some erroneous but widely held misconceptions, and really does a little "thinking outside the box" as they are prone to suggest.

### 8.4.1 Sweet Antigravity Test.

See again our discussion in paragraph 8.3.7. A practical realization of antigravity was clearly shown by the Sweet antigravity test designed by the present author. See previous discussion under paragraphs 6.3.2 in Chapter 6, and see again Figures 6-5 through 6-15.

In Chapter 6, the Sweet vacuum triode amplifier device shown in Figure 6-8 had a very large COP = 1,500,000 at 500 watts output with a 33 microamp, 10 volt operator's input. It had an even greater COP when pushed to 1,000 watts output because of only a slightly greater input.

The Sweet VTA used an induced powerful self-oscillation between the local vacuum and the barium nuclei in the barium ferrite magnets. This resulted in what is called a "kinetic" magnet (and one magnetized through its flat face). In a kinetic magnet, its nuclear magnetic field (in this case, in the barium nucleus) is self-oscillating (waving) in an angle about its local direction, as shown in Figure 6-6 in Chapter 6.

The conditioning was performed with the barium ferrite magnet itself in forced resonance at its resonant condition (some 11 to 12 Hz, in the case of Sweet's magnets). Then the 60 Hz signal was impressed orthogonally to the primary direction of the resonant magnet. After conditioning each of the two magnets, they were placed together on a separation box, carefully keeping the corresponding ends together similar to their original orientation during activation, but in attracting mode (through their face) across the separator. The assembly itself was then further conditioned, again orthogonally to the coupled oscillating fields. This "synchronized" the two magnetic self-oscillations and phase-locked them together in a common self-oscillation with the local vacuum.

Similar treatment of the vacuum as a semiconductor, together with self-oscillation between vacuum and nuclei, has been advanced independently by Prange and Strance {543}, who showed that the vacuum may be regarded as a semiconductor. In particular, they showed that the vacuum in the region close to the nucleus of a superheavy element is analogous to the inversion layer in a field effect transistor. It is similarly analogous for the barium atom, though Prange and Strance do not discuss that element. They introduced the concept of the inverted vacuum. Just as a semiconductor may be manipulated by subjecting it to external fields, doping etc., it appears that so can be the vacuum — along the lines shown by Prange and Strance and along the lines demonstrated by Sweet's conditioning of his kinetic magnets.



### 8.4.2 Bearden's Proposed Antigravity Mechanism

Any EM process that produces a COP»1.0 condition, such as can be done in intensely abrupt ionic discharges and other processes, will also produce intense causal (4-space) Dirac sea holes in the immediate surrounding vacuum. This is the negative energy mechanism, conceived by the author in the 1970s and finalized in the 1980s, for producing a negative energy causal (unobserved) EM field<sup>228</sup> in the immediate space surrounding a system. The overunity system must be the "source" of that negative energy EM field. So the negative energy EM field in surrounding local space is "attached" to the mass and energy dynamics of the "unit's supersystem" as being its "source or generatrix". Its attachment to the system mass produces the antigravitational force upon that mass.

Negative energy state charges (Dirac holes) are also *source charges*. Prior to observation converting them (as observed) to 3-space positive mass-energy positrons with positive energy and going the opposite direction, they must be accepted as negative energy source 4-electrons "pouring out negative energy" in all directions in 3-space, continuously, via the giant negentropy process for source charges. Since they pour out "negative" energy, we may consider that negative energy field action at any point in 3-space to be a continuous absorption of positive energy from 3-space and a return of that extracted energy to the time domain as increased time — in short, time dilation.

Either way one considers it, the 4-space Dirac holes do produce negative energy EM fields, potentials, and spacetime curvatures and these must be accounted during their existence *prior to observation and interaction*. Further, their accompanying giant Heaviside negative energy flow component must also be accounted. In other words, do not reverse the spatial direction and thus the location and direction of these fields, do not turn them into positive energy fields by such reversal of direction, do not turn the negative mass into positive mass, and do not reverse the sign of

<sup>228</sup> We strongly stress that the continuous, dynamic, ongoing causal 4-field before it interacts with charge and is observed, is a totally different entity from the iteratively and continually observed frozen "effect" 3-field in matter after the 4-field has interacted with charged matter to produce an observation or "event". The great barrier to using electromagnetic fields in practical antigravity application has been due to the substituting, in electrodynamics, of the iterative "effect" 3-field of the observed positron for the continuous "causal" 4-field of the unobserved negative energy 4-electron (the Dirac sea hole). The "effect" 3-field is simply the iterative, continual energy gradient of the diverted EM field energy flow around the assumed intercepting unit charged particle.

the source charge (the Dirac sea hole). All that happens after interaction of the Dirac sea holes with matter, forming the usual lattice holes or *observed* 3-positrons.

*Therein lies the magic secret of antigravity.* Instead of thinking of the *fields* interacting on the craft or system that is producing them,<sup>229</sup> think of these negative energy fields interacting upon the *local spacetime surrounding the craft or system, and curving that spacetime negatively.* Then think of this negative curvature of spacetime interacting back upon the craft or system in general relativity fashion. *That* is what will and does produce practical antigravity upon the interacted craft or system, once the Heaviside energy flow component is accounted! But to understand its magnitude and the practicality, one must also account for the long neglected Heaviside nondiverged component.

The mechanism is also consistent with general relativity and Wheeler's succinct statement that mass acts on spacetime to curve it, and curved spacetime acts back on that mass to move it or produce a translation force upon it. We are simply applying that fact of general relativity to produce a local antigravity effect of a locally curved spacetime upon the source system (in this case, the power system itself, which is the source of the negative field energy in the vacuum.

The entire notion of "curvature in spacetime" — and indeed of spacetime itself— is a notion applying *before observation and interaction to produce the observed effect* — i.e., prior to the  $d/dt$  operation occurring upon an ongoing 4-space process to produce a momentary frozen 3-space snapshot (an observed effect). Think carefully. Wheeler's rule does not mean that 3-space acts back on the mass (actually on the masstime), but that 4-space (spacetime) acts back on it. Spacetime does not exist in the observed object after the application of observation's  $d/dt$  operation has occurred and until a new causal interaction begins. The  $d/dt$  operation strips away the time,

<sup>229</sup>The ongoing interaction of the vacuum/spacetime with the source of the unobserved 4-fields is their cause, and the observed 3-fields are the effect. The effect *a priori* does not interact upon the cause! So thinking that "one should make a 3-field in a craft or system that will interact with it and produce antigravity force upon it" is a non sequitur. Instead, one more correctly thinks that "one should make a 4-field *from* a craft or system which will interact with the local spacetime to curve it negatively. Then that negative curvature of spacetime is itself a negative energy 4-field that will interact back upon the observed craft or observed 3-system to produce observed antigravity force upon it.

and hence most of the energy (i.e., all the time-energy) of the spacetime that is to do the interacting.

As source charges, the Dirac sea holes — before observation and in their vacuum state condition — produce a locally curved *spacetime* around the source unit. That induced (*negative energy x time*) curvature interacts back upon the physical system that is the source of the field producing the negative spacetime curvature. It specifically acts upon the mass of the 4-system when it exists as (*mass x time*)*form*. That interaction produces *antigravity* force and momentum upon the system, rather than *positive gravity* force and momentum<sup>230</sup>. Adding negative EM field energy (in the causal, unobserved state) is precisely the same as adding extra negative *masstime*, i.e., extra  $(-m)t$ , since the 4-field is being used in unobserved state.

Using the principle of superposition of fields<sup>231</sup>, the external observer sees the "weight" of the unit (the force developed on it by the *net* gravitational field — see again our discussion of the Newtonian approach under paragraph 8.2.1 above) — as being reduced. The intensity of the *negative energy x time* (*negative angular momentum or negative action*) EM field (including with the Heaviside component accounted) produced by the unit determines the intensity of the antigravity produced, and hence determines the fraction of the unit's weight<sup>232</sup> that is observed to be "lost". See again Figures 6-14 and 6-15 in Chapter 6.

<sup>230</sup> Note that, if the Dirac hole interacts with the mass lattice of the system, it converts to a "hole" that is attached to the positive mass of an ion. Hence the "observed" positron is said to have "positive mass", which is a non sequitur for the state in which the "positron" exists prior to observation or interaction. The lattice hole 3-positron and the true spatiotemporal "4-positron as still a negative energy 4-electron" are two very different entities, and their fields and concomitant field effects are very different.

<sup>231</sup> Note that identification of spacetime and field in general relativity extends the notion of superposition of multiple fields to the notion of superposition of multiple curvatures of spacetime. Thus, it is the *net* superposed curvature of spacetime that interacts back upon the physical mass system, to produce gravity (either positive or negative, depending on the sign of the net curvature).

<sup>232</sup> We remind the reader that the "weight" of an object on Earth is a measure of the force developed on the object by the (Earth's) gravitational field. "Loss of weight" is simply "reduction of that net force" due to the combination of the Earth's positive (attractive) gravitational field and the Dirac hole curvature of the object's local spacetime producing a negative (repulsion) gravitational field.

At sufficient intensity of this local negative energy 4-field in spacetime with the unit as its source, the back interaction upon the unit will balance the action of the earth's gravitational field. At that point, the unit will hover and "float" against the force of terrestrial gravity.<sup>233</sup> By further increasing the intensity of the negative energy EM field, the unit will accelerate upward, now being repelled by the local earth more than it is attracted by it. By "angling" the negative energy EM field direction — or by producing a second such negative energy EM field from the source unit as an "angled add on" superposed on the first one — one also provides unilateral propulsion in a given direction.

As can be seen, all the requirements for a practical antigravity vehicle and negative energy propulsion system are met. The only real problem in this approach is the requirement to first attain a  $COP \gg 1.0$  EM power system at ELF frequencies.<sup>234</sup> There is, however, an additional problem of correcting one's thinking to be along the lines indicated.

Antigravity becomes straightforward if one first does overunity discharges or steady output in a system with  $COP \gg 1.0$  and understands the difference between the observed "effect" 3-field and the unobserved "causal" 4-field. Sweet's VTA unit had a beginning  $COP = 1,500,000$  at 500 watts output. The unit was pushed to nearly double its COP, by connecting additional load so that the output was now 1,000 watts. The additional input draw was minimal.

Designing the experiment with that in mind, I convinced Sweet to build a new output load unit, and to perform the experiment. In advance, I roughly predicted levitation of the 6-pound device at about 1500 watts output power, by some back-of-the-envelope estimates assuming a 10% efficient

<sup>233</sup> Sweet later did push the VTA to hovering and upward acceleration, with the unit on a tether. After he was shot at by a distant sniper, thereafter he was very fearful **and** refused to show many experiments, including the antigravity experiment and particularly its extension to the hover point and upwards acceleration extension. In my opinion he had good reason for his paranoia and his fear for his life.

<sup>234</sup> The reason for ELF frequencies is simple: for the most powerful curvatures of spacetime, one wishes to use EM fields whose photons have the greatest *total* energy (including time-energy). That of course is the lower frequency photons, not the higher frequency photons. So ELF is the way to go, not gamma rays etc.

process. The projected curve (again see Figure 6-14 in Chapter 6) shows that levitation would have occurred at about 1250 watts or so.<sup>235</sup>

Here is why we advocate a Dirac sea hole's negative energy field as a practical antigravity inducing mechanism.<sup>236</sup> At  $COP \gg 1.0$ , there is a very appreciable vacuum energy density difference between the operator's energy input and the energy output of the system, *particularly when the Heaviside nondiverged energyflow component is taken into account as well as the Poynting energyflow component*<sup>237</sup> There is a production of negative EM mass-energy x time (causal Dirac sea holes) in the immediately surrounding vacuum. That represents the production of a causal, unobserved antigravitational field (curvature of spacetime) with the system-associated anticharge as its source.

Meanwhile, the Earth's causal, unobserved gravitational field is still normal and unchanged. Now the two causal fields superpose, and interact with the system mass. As seen by the external observer, the net effect is a reduction in the weight of the object — the effect of the interaction of the system mass with the two superposed causal gravitational fields simultaneously.

Reasoning that increasing the COP of the Sweet unit should increase the ratio of output negative energy to output positive energy even further, 1

<sup>235</sup> I strongly warned Floyd not to exceed a 1 KW load, no matter what. In the resulting local curved spacetime surrounding the barium nuclei in the magnets, it appears that magnetic monopoles are deposited or appear. Since these barium ferrite magnets were made by pressed powder metallurgy, they had little tensile or torsion strength, and under sufficient stress they would explode violently like a fragmentation hand grenade. In his little lab (a converted bedroom), Floyd had no explosive facility. He did explode several magnets, but while cautiously remaining some personal distance from the unit as its output was increased. We warn the reader that experimentation with such procedures is at his own risk, and all proper laboratory safety precautions must be utilized.

<sup>236</sup> A provisional patent application has now been filed on the process in 2002.

<sup>237</sup> In a nominal circuit, the unaccounted Heaviside energy flow may be up to  $10^{13}$  times as great as the Poynting energy flow component. This is a completely unaccounted, vast EM energy flow accompanying every field and particle interaction. Hence one can understand why such an energy density for a macroscopic system with  $COP \gg 1.0$ , is sufficient to achieve on a macroscopic scale what LaPointe is attempting on a microscopic scale. The total macroscopic scale energy density is so great that the required LaPointe microscopic energy density {535} is present or approached.

calculated that doubling the output of the device would result in a sufficiently intense negative mass-energy field in the immediate space around the unit, to approach or reach levitation of the unit. However, as the increasing curvature of spacetime would further increase the deposition of magnetic monopoles in the magnets,<sup>238</sup> at some point the magnets would simply explode like hand grenades if the unit were pushed too far. With no explosive control facilities available, it appeared that doubling the output was the maximum that could safely be done under the circumstances. My own estimate showed that 1500 watts output would be required for levitation, but one dared not go beyond 1000 watts or one would risk a fragmentation explosion and injury or death.

I convinced Sweet to build a 1,000-watt output load box, which simply contained ten sockets for ten 100-watt light bulbs. This was a modification to the 500-watt VTA unit shown in Figure 6-8 in Chapter 6. By successively installing the bulbs one by one, the load could be adjusted in 100-watt increments up to 1 kilowatt.

The foregoing is the reasoning behind how I designed the experiment, and the purpose was to show very substantial and smooth weight loss of the VTA unit itself. The experiment was performed in that 100-watt incremental manner, with highly successful results as shown in Figure 6-14 in Chapter 6.

With each 100-watt increase in power output past 500 watts, the fraction of negative energy produced was greater. Hence the unobserved 4-positron fields (Dirac sea hole negative energy fields) were stronger, because there were more unobserved 4-positrons. This meant that the local negative mass-energy curvature of spacetime was increased also.

In turn, this negative curvature of spacetime interacted back upon the mass of the VTA to add negative mass equivalent, or more simply, antigravity force. The observed weight of the unit was the sum of the normal gravitational weight (due to earth's gravity curvature of the local spacetime), and the abnormal antigravity weight (negative weight) due to the antigravity curvature of the local spacetime superposed. So as the fraction of negative curvature of spacetime increased, the net weight of the VTA was observed to decrease.

<sup>238</sup> Contrary to popular opinion, one does meet with effective magnetic monopoles in a magnetic field — including in the magnetic field of a permanent magnet — in a strongly curved local spacetime. The stronger the field, the greater the magnitude of the effective monopole charge.

As stated, Sweet was performing the experiment on the bench in California, and reading the instrumental results over the phone (I was in Huntsville, Alabama) where I recorded them. The spectacular results are shown in Figure 6-14 in Chapter 6.

The high COP (corresponds to gain) of energy density present in the Sweet VTA system's output section — with a greater percentage of it being negative energy — versus input energy one inputs to the input section, is what is important. In short, increasing the load effectively increased the gain, which further increased the ratio of the negative mass-energy to the positive mass-energy. This in turn steadily decreased the observed weight of the object.

Anything outside the system mass of that very high COP system will "see" the weight of the system mass as having decreased. Weight is just so much mass making so strong a *net* G field (spacetime curvature) in the surrounding spacetime. Reduce the *net* G-field that the system mass is normally making (by having it *simultaneously* make the additional antigravity field which then vectorially adds to the mass's normal G-field), and the external observer, external scales, etc. will see the object as having very much reduced its weight.

Positive spatial EM energy density of a system makes positive gravity (as seen by the external observer in the lab frame) because of the way it curves the immediately surrounding spacetime and the way that curved spacetime interacts back on the system's mass-energy. Negative spatial EM energy density makes negative gravity because it curves the immediate spacetime the opposite way. A system under those "high negative energy field" conditions will produce a great deal of antigravity, because the immediate spacetime surrounding is dramatically curved by the negative energy. That was my concept when designing the experiment, and it worked beautifully. So that is how the Sweet device reduced its weight on the bench by 90%, for a 1 kilowatt total output and minuscule input power {544}.

If one were dealing with the source in a flying vehicle system, there is another effect due to momentum. Note that force  $F$  is defined as  $F \equiv \partial p / \partial t = +\partial / \partial t (mv)$ . That is in a positive energy density local spacetime. When an extra negative energy density is added to the local spacetime, then there are two forces, a new one being  $F \equiv -\partial / \partial t (mv)$  and the normal one being  $F \equiv +\partial / \partial t (mv)$ . These forces are created by any change in momentum in space containing an extra increment of negative EM field energy.

If the two forces balance, then there is essentially no net centrifugal force produced on the object (or any occupants in it) in a turn. In theory, maneuvers that are far more powerful can be made, without undue G-stress to any occupants inside. This of course remains to be tested in future work and experiments, and so must be taken as a strong hypothesis at present. It could be tested, given availability of the proper COP»1.0 energy system or process on board a test vehicle. Laithwaite's demonstration of the dramatic reduction in force necessary to lift a rotating gyroscope compared to lifting the same heavy gyroscope when not rotating, may have been a partial test of this "inertial resistance decrease" effect.

The Sweet device was the only available COP»1.0 device which could have been used for the experiment. That is why I designed the experiment and convinced Sweet to perform it. Had it not worked, much of what I had worked out for more than a decade would have been falsified — which of course is one of the purposes of experiment: to validate or falsify a thesis. In this case, I breathed a great sigh of relief because — in my view — the spectacular results completely validated my approach to antigravity, and also much of my approach to COP>1.0 systems.

Sweet was never in a position to be able to go with this to the scientific community. The VTA was completely fouled legally, by various entangling agreements Sweet had made with different backers, without ever changing or resolving any previous agreement. Also, he realized that his life really was in danger should he try to take the system openly to the scientific community. Consequently, he never tried and in fact adamantly turned all further work away from the antigravity effects.

Aging and rather defenseless, Sweet also began playing all sorts of games to prevent having to have the project validated independently, even for its COP>1.0 capability. He was mortally fearful of being killed if he had it resoundingly validated. He was motivated by the necessity to survive and not be killed, and he firmly believed that any such attempt for full scientific validation and open publicity would absolutely guarantee his quick death. His fears appear to have been well founded.

His most carefully guarded secret was his activation process for the barium ferrite magnets, which he guarded with his life. He also began telling different persons all sorts of different stories and "mechanisms" for the activation, which were clever ruses and disinformation designed to throw them off the true trail and prevent his activation secret from being uncovered. I made a personal videotape of the activation process, or what



he released of it, before he began such disinformation. So we do know much of the activation process, though not all of it.

Eventually, with changes in backers yet once again, Sweet died and never revealed the full secret of strong self-oscillation activation in permanent magnets to anyone. I knew and know part of it, even most of it, but still not all of it. What I understand about it has been briefly included in this book. From there, the interested researcher must find his own way.

The VTA was real, my gravitational mechanism is real, and — in my opinion — validated. However, it has not been *independently* validated in formal order, which is the proper scientific requirement. I did try very hard to convince Sweet that we should take this to the leaders of the scientific community and have it independently verified (e.g., by UCLA), but he would not hear of it after the assassination attempt. By that time, he was so afraid from the constant threats and constant stalkers that he had totally decided against any such releases. He also would not permit it to be taken to a major scientific conference and demonstrated, even though several scientists and engineers knowledgeable and experienced in measurement engineering did measure and certify the device's operation. But they were never allowed to see it in the antigravity mode. He would not discuss it with them, and he would not allow it.

Sadly, with the death of Sweet there passed away the VTA and its major secrets. I regard the VTA as one of the great scientific accomplishments of all time, and I regard Sweet as one of the most capable lab experimenters I ever met and one of the greatest inventors I ever met. The loss of the VTA and the absence of its full, independent scientific testing and validation were in my opinion two of the greatest losses to science of all time.

#### 8.4.3 Discussion

Particle physicists speak of antimass and antigravitational field, but do not speak of anti-electromagnetic field and do not like negative mass. Antimass is actually "anti-mass-energy". When did one hear any scientist speak of a *negative energy* electromagnetic field or *negative energy* force field (except possibly as a hypothetical "tractor beam")? Or a *negative energy* electrical or magnetic potential? Yet the EM fields from an accumulation of Dirac sea holes (causal state) as a source charge are precisely negative energy EM fields. The EM potentials from an accumulation of Dirac sea holes are precisely negative energy potentials. Further, these fields and potentials produce opposite curvatures of spacetime as compared to positive energy causal EM fields and potentials from conventional source positrons and electrons.

Conventionally, scientists speak and think of *the positive energy* electromagnetic field. In our view, they do not apply the implications of the negative energy state part of the Dirac 1930 electron theory {545}, because of a built-in horror of negative mass (and antigravity!). Recall again our discussion of Laithwaite; a promising career was cut down in mid stride because he "mentioned the unmentionable": antigravity and possible failure of Newton's laws (they *do* fail in a curved spacetime!). His exhibiting to the Royal Society a very heavy gyroscope, very difficult to lift when placid, but easy to lift with one arm when spinning, was the final straw. The British scientific community simply cut him down and ostracized him from the rewards and positions he would otherwise have been given.

To conceal the relationship of the negative energy fields, hide negative mass, and pretend it does not exist, much scientific effort is exerted to consider the positive energy, positive mass positron *only after it has been observed*. So scientists can assign this "observed" 3-positron a positive mass and positive energy but with spatial direction reversal. That immediately moves to an *effect* field and an *effect* positron, not a causal field or a causal Dirac sea hole. It effectively eliminates the antigravity field of the negative mass of the unobserved negative energy Dirac electron, which is produced by the *causal* (unobserved) Dirac sea hole's electromagnetic field, not the *effect* (observed) positron field which then is "seen" to have positive mass but with field direction reversed.<sup>239</sup>

The positron is quite a different beast before it is observed, just as is a mass (and just as is any other observable, and just as is a field). For one thing, the positron before observation and the positron after observation have different dimensionalities; the unobserved causal entity is 4-spatial and continuous,<sup>240</sup> while the observed effect entity is continually and

<sup>239</sup> Note also that the causal field, being unobserved, is a 4-field, while the observed (effect) field is a 3-field. By reversing the parity, one has made the antigravity field **into** a gravity field, by substituting the effect for the cause and erroneously using the old non sequitur of a separate 3-force acting upon a separate 3-mass. Also, when one reverses its spatial direction, one converts a *positive* gravity field into an *antigravity* field.

<sup>240</sup> Along with Bohm, we point out that — strictly speaking — in 4-space one does not have "things", but only "processes". To speak of a "4-space field" is to redefine the field as an ongoing process, rather than as an observed frozen 3-snapshot or "3-thing". The solution to the long-vexing duality problem is there, but we leave its solution to the reader. It is necessary to extend Aristotelian logic itself if one is to resolve the duality problem.

iteratively 3-spatial. Mass before it is observed exists as *masstime*, not mass.

Simply consider the delayed choice two-slit experiment and Wheeler's famous comment that no phenomenon is a phenomenon until it is an observed phenomenon. Once the observation occurs, one can even change the "if it had been observed but was not" previous past. One gets the magic from the delayed choice two slit experiment without the observation, and then by making the observation such that the "magic" is not revoked *after the fact*. The whole experiment proves that, if one insists on applying the observation, one kills the magic, even if one thinks the magic has already occurred and must have already occurred, but it has not been *observed* to have occurred.

Causal 4-spatial "things" are not things at all, but are ongoing processes and their cessations have not "occurred" to yet produce a "thing"! The *observed* event is 3-spatial and has occurred. It is something in the past, not the present. That is different from something ongoing (happening or unhappening)<sup>241</sup> in 4-space, before having been observed and therefore a frozen snapshot taken in 3-space. As is well known in quantum mechanics, observation is a physical interaction and it indelibly changes and stops the "ongoing 4-process", converting it to a momentarily frozen "3-thing" as an effect of the observation process at that particular instant. So any "thing" is continual and iterative, *not continuous*, in its travel through time, and in its "observed existence in 3-space".

Because of such, physicists also have difficulty realizing that mass — being an observable — does not and cannot exist continuously in time. It cannot even *continuously exist*! No observable can. *Masstime* exists in time, but mass does not, as we previously discussed. Observation is a *d/dt* operator imposed upon an ongoing 4-space process, destroying the time

<sup>241</sup> When a frozen instant 3-space snapshot (observable) interacts with a second causal process to generate another frozen snapshot (observable), the first observation "unhappens" because it is thereby moved into the "past", disappearing from 3-space forever. With every change of an observable (with every observation), even if the new effect appears identical to the previous one, it is still a *new* observable (a new effect) where a former effect "seems" to have recurred (been created, happened). Even if it is spatially the same as the previous observation output, it is at a different point in time and hence is the result of the *d/dt* observation operator being iteratively applied. The serial outputs — even of what we loosely call an "entity existing in time with no 3-space change" — are *successive and different* serial outputs from a serial time-differentiating process.

portion and producing an instantaneous, frozen snapshot at that instant. It's just  $d/dt$  (LLLT)  $\Rightarrow$  LLL. That is why all observation is 3-spatial, as is well known in physics. We long ago pointed out how the common photon interaction — the total photon interactions (both virtual and observable) with a mass — is what drives the mass through time, so to speak {15}. But it does it iteratively, frozen snap after frozen snap —just like progressively showing the frames of a movie film.

What really has to be changed is the old notion by Heaviside and Poynting that 3-energy propagates continuously through 3-space.<sup>242</sup> No observable can propagate continuously in 3-space, but only in 4-space and then only during its nonobservable state! So a "mass propagating through time" (i.e., just sitting still and "existing", so to speak) is doing so in an iterative fashion by recurring iteratively in observation output at the same spatial position. The mass turns to masstime, then to mass, then to masstime, etc. Or  $m_1 \Rightarrow m_1t \Rightarrow m_2 \Rightarrow m_2t \Rightarrow m_3\dots$  etc. In short, *observation continually recurs at an enormous rate, so an observable (effect or output of that observation process) continually recurs at an enormous rate, destroying the previous observation as the next one occurs.*

Because of the history of thinking in 3-space terms rather than 4-space terms, one of the ubiquitous errors widespread in physics is the substitution of the effect (the frozen output of the observation process) for the cause (that 4-space initiator process which continuously exists prior to observation, hence unobserved). So causes (4-space initiators which are unobservable a priori) interact with a previous "frozen 3-space snapshot" or observable, to produce a change (either a temporal change or spatial change or both) in or to or of that observable (that 3-snapshot) to a new observable (3-snapshot). If the object is seen to iteratively change in time but not position or form, it is said to "exist" or "persist" at rest continuously in time. It doesn't. It *continually recurs*<sup>243</sup> in that form, but does not *continuously exist* in that form!

<sup>242</sup> And also the hoary old mistaken notion that the "same observable thing" can continuously exist in time or persist.

<sup>243</sup> More rigorously, the continual recurrence is at the quantum level. So a larger mass or other observable actually is a great horde of very small "continual recurrences" of tiny incremental pieces of itself. At any time interval of observation via observable photons, a vast number of nonobservable (virtual) "continual recurrences" occur in the "observed object". In short, the "observed object" is the **end** summation and result of a vast number of infinitesimal changes. Hence the entry of statistics and the uncertainty principle. Each one of the infinitesimal

The antigravity mechanism has been implicitly present in the Dirac theory of the electron since his 1930 paper {497}, where he brought forth the Dirac sea and the anti-electron, if the *causal* Dirac sea negative energy states are applied to general relativity before they interact with charge and are "observed". General relativity deals with spacetime and spacetime curvature. Therefore, it is concerned with causal 4-fields, 4-potentials, and 4-waves in 4-space prior to observation.

As we stated previously, there is really no such thing as a "3-space EM wave", e.g., as rather strongly pointed out by Romer {546}.

One can produce and have an EM field of *negative* EM energy in spacetime, coming from the 4-positron charges of the anti-charged mass of a system, as well as one can produce and have an EM field of *positive* EM energy in space, coming from the charged mass of a system. But negative energy EM fields have been swept away from our minds by interpreting the negative energy 4-electron as the 3-positron, after the negative energy 4-electron has interacted with charged matter (been observed as the *effect*), rather than how it exists in spacetime prior to observation (as the *cause*).

So physicists reverse the direction and the charge, and make the mass positive, which is how the Dirac sea hole is "seen" *after observation*. That makes it a material lattice hole and a special kind of positive ion. Before observation, it is not seen at all, but it exists as negative action (energy x time) and therefore in "negative masstime" state form. Before it has been observed, it's still there in spacetime, as a curvature of spacetime. It's just a *negative energy state curvature* in the vacuum/spacetime.

Make lots of these negative mass-energy state Dirac holes from a source system, such as one producing a very powerful negative energy EM field, and voila! That's it. The system is producing — and surrounding itself by — its own negative energy EM field (negative curvature of 4-space), which is also its own local antigravity field. That antigravity field superposes with the prior local curvature of spacetime, altering it. The *net* curvature of local spacetime is itself a field which interacts back upon the mass system to produce "net gravity" whose sign may be positive or negative, depending on the sign of the net spacetime curvature. If the two back-acting curvatures of spacetime are opposite and equal, that represents the source object existing in a zero gravitational field, and thus "hovering" in the Earth's gravitational field, for example.

changes may be modeled causally, but since there is no individual information available on each one of them, they can only be calculated statistically.

The use of negative energy EM fields and Dirac sea holes to alter the curvature of the local spacetime in a negative direction provides the present author's engineering approach to practical antigravity. Note that our approach gathers in the gist of both of the major two approaches to antigravity: (1) the shielding theory as typified by Modanese {547}, and (2) the opposing force theory as typified by Ling Ni and Torr {548}. The opposing force, considered as a field that is identically a curvature of spacetime, is also a "gravity shielding" force via superposition of fields. We state unequivocally that a theoretical model of the new approach can be constructed from Sachs's theory {510}, and implemented in the 0(3) electrodynamics of Evans and Vigier {549}. Further, it is a directly engineerable theory, without the necessity for superconductivity, spinning wheels, etc. as demonstrated by the highly successful Sweet experiment previously discussed.

We quote Evans {550}, on the appearance of the  $B(3)$  field in general relativity, to indicate the nature of such a future theoretical model:

*"I have chosen a metric that gives circular polarization (as observed), but in the framework of general relativity using the irreps of the Einstein group according to the Sachs theory. This is a closed field theory which is analytical, using a Lie group, the Einstein group. As such there are no particles, only spacetime curvature, so everything in physics reduces to spacetime curvature, i. e. to a metric vector and its components. This is then incorporated in the Sachs theory to produce a metric four-vector which is a generally covariant component of a quaternion-valued metric with sixteen components, the most general form of the metric allowed by general relativity and topology. The Einstein-Sachs equations for electromagnetism are six metrical equations in six unknowns, the components of an antisymmetric field tensor of electromagnetism. By choosing a metric that corresponds to circular polarization,  $B^{(3)}$  appears automatically.*

*This method gives the  $B^{(3)}$  field from Einstein's theory of general relativity applied to electromagnetism by a consideration of the irreps of the Einstein group. It follows that whenever the conjugate product  $-gA^{(1)} \times A^{(2)}$  is observed, the  $B^{(3)}$  field must also be observed, otherwise general relativity fails. Examples of*

*the  $B^{(3)}$  field at work are the inverse Faraday effect and RFR [Radiatively induced fermion resonance]."*

Evans and the AIAS have already taken the first theoretical steps showing that antigravity does indeed arise from Sachs's theory {551a-551c}.

We are convinced that practical antigravity only occurs at extremely low frequency (ELF) for reasons<sup>244</sup> explained previously. Certainly that seems to be true for our approach to it. The highest "total energy" photon is the low frequency photon with low spatial energy and a larger time increment. The larger time component has the same energy density as mass. So one multiplies the time component increase (in seconds) by roughly  $9 \times 10^{16}$  to get the increase in spatial energy equivalency. Halve the frequency of a photon, and one increases its *total energy* by  $4.5 \times 10^{16}$  {552}.

High energy physicists have not realized that the time component of the photon has enormously more energy than the spatial component, and that low frequency photons contain enormously more trapped energy than do high frequency photons. So they largely ignore the time-energy component, focus on the spatial energy component, and erroneously consider *high energy* physics as *high frequency* photon physics. Instead, present high frequency photon physics is only a high *spatial* energy physics, not a high *total* energy physics at all. Today's high energy physics is really still a very low total energy physics, compared to what can be done with the time-energy component of the photon rather than its spatial-energy component. By transducing and using the highly compressed time-energy, experiments can be done on the lab bench with fairly simple and cheap equipment, that actually utilize *higher total energy nuclear reactions* (though at low spatial energy) than are presently obtained in the largest accelerators.

That is also why there is presently no understanding in the conventional community of the "low spatial energy transmutations" of cold fusion, where the experiments unwittingly use the high time-energy component. The scientific community has not even recognized the time-energy aspects,

<sup>244</sup> Dramatic increase in the magnitude of the time-component, hence an enormous increase in the time-energy component with only a small decrease in the spatial energy component total energy of the photon. The *total energy* thus dramatically increases, when the spatial energy equivalent of the time-energy is considered. The present conservation of energy law in physics is inadequate because it does not account time energy at all; thus completely discards the most fundamental EM energy mechanism of all: the giant negentropy of source charges and source dipoles.

and has not recognized that time-energy physics is an ultrahigh total energy physics, where the present "high energy physics" is tame by comparison.

The previously unknown time-energy induced transmutation interactions are the precursors to, and the opening salvo of, a new *ultrahigh total energy physics* struggling to be born in spite of the adamant opposition of the conventional scientific community. Allowing for the time-energy component, for the mechanism generating the flow of time, and for formation and decay of time-reversal zones, we previously wrote the exact new nuclear reactions for the production of the excess deuterium, tritium, and alpha particles {553} in numerous cold fusion experiments. We also explained the highly anomalous nuclear instrument effects — due to (i) time-charging, (ii) the slow decay of time-charge with radiation of Whittaker longitudinal waves, each accompanied by its phase conjugate twin time-polarized wave, and (iii) the previous time-charge history of the instrument. These puzzling anomalies have been observed at U.S. Navy research facilities at China Lake now for some years in rigorous electrolyte experiments {198}. We summarize that work in Chapter 10 of this book.

With a little effort and development, practical antigravity appears to be straightforward for any good modern laboratory. But the lab physicists should first (i) rethink the entire subject, from its very fundamentals, to include considering the positron before observation and not after observation, (ii) remove the Lorentz symmetrical regauging from electrodynamics and recover the presently missing COP  $>1.0$  and COP  $\gg 1.0$  Maxwellian systems again, and (iii) rapidly develop COP  $\gg 1.0$  systems and processes to use in antigravity experiments and development. At least in this approach, the COP  $\gg 1.0$  EM systems — once developed — are an immediate gateway to practical antigravity devices, unilateral thrust propulsion systems, and antigravity vehicles. And of course they are the immediate gateway to practical transport vehicle power systems, fuel-free, clean, and self-powering.

Hopefully, such a scientific reassessment will be performed, and it may provide the gateway for practical transportation and travel to the ends of **the** solar system and beyond, to be achieved in the first two decades of this century.

## 8.5 In Conclusion

We have briefly reviewed the presently developing field of inertial space propulsion and antigravity, and presented our own approach to practical



antigravity as well as an informal experiment that strongly supported that approach. We have strongly stressed that the causal field from the system as its source constitutes a curvature of the local spacetime superposed upon the pre-existing local spacetime curvature. Instead of thinking of that causal field from the source system as acting back upon the source system, we have stressed thinking of that *net superposed curvature of local spacetime* acting back upon the source system and producing a net gravitational force upon it. That net gravitational force may be either positive or negative, or zero, depending upon the sign of the net curvature of spacetime that is interacting back upon the system.

We presented and explained the results of the Sweet VTA antigravity experiment as probable verification of our approach to antigravity. Nonetheless, we also emphasized that the formal independent replication required by the scientific method has not been accomplished, and it remains to be accomplished before the approach is to be considered as scientifically validated.

We believe that this approach to antigravity can be modeled and engineered by use of the Evans-Vigier  $O(3)$  electrodynamics as a subset of the Sachs electrodynamics that is a part of the Sachs unified field theory.

If so, then tentatively we have laid out the basis for eventual practical antigravity systems and a practical antigravity technology. We fervently hope that this approach will in fact lead to practical technology and working transportation means during the next decade.

Finally, we hope that these notes and concepts will stimulate many sharp young graduate students and post-doctoral scientists to examine, model, correct, and greatly enlarge the ideas and principles advanced. If so, then the purpose of this chapter will have been realized.

## Chapter 9

# The Supersystem and Remarks on Gravity, Antigravity, and Testing

*"What might appear to be empty space is, therefore, a seething ferment of virtual particles. A vacuum is not inert and featureless, but alive with throbbing energy and vitality. A 'real' particle such as an electron must always be viewed against this background of frenetic activity. When an electron moves through space, it is actually swimming in a sea of ghost particles of all varieties - virtual leptons, quarks, and messengers, entangled in a complex melee. The presence of the electron will distort this irreducible vacuum activity, and the distortion in turn reacts back on the electron. Even at rest, an electron is not at rest: it is being continually assaulted by all manner of other particles from the vacuum." [Paul Davies] {554}.*

*"Space acts on matter, telling it how to move.. In turn, matter reacts back on space, telling it how to curve." [Wheeler's principle] {555}.*

*"...the Aharonov-Bohm effect is a local gauge transformation of the true vacuum... [which] produces a vector potential from the true vacuum. [This gauge transformation] produces topological charge..., the electromagnetic field, which carries energy, and the vacuum charge current density first proposed by Lehnert... and developed by Lehnert and Roy... ". [M. W. Evans and S. Jeffers] {556}.*

*"The energy density ( $E_n$ ) in curved spacetime is given in the Sachs theory by the quaternion-valued expression*

$$En_d = A_m j_m^* \quad [1]$$

where  $A_\mu$  is the quaternion-valued vector potential and  $j_m^*$  is the quaternion-valued 4-current as given by Sachs ...Equation [1] is an elegant and deeply meaningful expression of the fact that electromagnetic energy density is available from curved spacetime under all conditions; the distinction between field and matter is lost, and the concepts of "point charge" and "point mass" are not present in the theory, as these two concepts represent infinities of the closed-field theory developed by Sachs from the irreducible representations of the Einstein group. The accuracy of expression [1] has been tested to the precision of the Lamb shifts in the hydrogen atom without using renormalization of infinities. The Lamb shifts can therefore be viewed as the results of electromagnetic energy from curved spacetime." [Myron W. Evans] {557}.

"Old habits of thought die hard, and it is not always easy to remember that a particle with negative mass if pushed to the right will move to the left; or that in a given reference frame a particle with imaginary mass can have infinite speed, in which case its energy is zero." .... "... extremely powerful energy sources may occur if particles of negative mass really exist in nature." [Banesh Hoffman] {558}.

"The observed (3-spatial) positron is a quite different entity from the unobserved (4-spatial) Dirac hole. Its direction has been reversed, and its mass and energy have also been reversed. Before the 4-spatial hole in the vacuum has interacted and been observed, it has negative energy and therefore negative mass equivalency, as well as negative charge. As a source charge, it also is the source of negative energy fields and negative energy potentials — all in the

*nonobservable 4-state.* " [T. E. Bearden, private communication to a correspondent, 2001].

*"The...visible structure of orthogonal' 1-networks possessing coupled open-paths and closed-paths represents only an introductory step in the development of a correct topological theory for conventional electric networks...An electric network is like an iceberg...Its visible portion is only a small fraction of the submerged invisible structure.* " [Gabriel Kron, who developed special tensor methods and diakoptics to deal with the large number of visible and invisible multidimensional p-networks surrounding the branches of every electric circuit.] {559}.

*"...symmetry implies conservation. Since our entire edifice of interactions is built on symmetry assumptions, there should be as a result a large number of conservation laws. The only trouble is that almost all of these conservation laws have been violated experimentally. "... "...this difficulty could be resolved by introducing a new element, the vacuum. Instead of saying that the symmetry of all matter is being violated, we suggest that all conservation laws must take both matter and vacuum into account. If we include matter together with vacuum, then an overall symmetry could be restored"* [T. D. Lee] {560}.

*"One perhaps oversimplified way to deal more conventionally with the new unified field approach to electrodynamic systems is to utilize the notion of the 'supersystem', comprised of three components: (1) the ordinary EM system and its dynamics—conventionally assuming flat spacetime and inert vacuum, (2) the local nonlinear vacuum and its dynamic interactions with the system and with spacetime, and (3) the local curvatures of spacetime and their dynamic interactions with the system and with the local*

*active vacuum. In the rich feedforward and feedback interactions that result, there emerges a dramatic new physics, new electrodynamics, and new chemistry including a new biochemistry. This is in fact a much simplified conceptual approach (good to 'first order', so to speak) to the multinetwork and multipath work of Gabriel Kron. It also allows the retention of symmetry, considered so necessary to particle physicists. "*  
 [T. E. Bearden, private communication to a correspondent, 2001].

## 9.1 The Supersystem and Its Considerations

In classical electrodynamics, the Maxwell-Heaviside-Lorentz equations implicitly assume a local flat spacetime and no net action by the vacuum {561}. Both these implied assumptions are false. All real EM systems involve interactions with both curvatures of spacetime and the active vacuum. Yet to try to include both additional interactions requires a unified field theory approach, such as that of Sachs {562}. Unfortunately, any unified field theory is replete with quite difficult mathematics, little of which can be illustrated pictorially or simply.

What is required — at least for most electrical engineers and applied electrical scientists — is a conceptual way of visually thinking about the EM system in a way that is consistent with unified field theory to something like first order, but which can also be conceptualized easily.

### 9.1.1 The Supersystem Concept

Accordingly, we introduce a new and very simple way of thinking of electrical circuits in terms of a unified field theory. We utilize the notion of the supersystem, consisting of three components: (1) the EM system and its dynamics, considered in conventional fashion (as if the local vacuum were inactive and the local spacetime were flat but perturbed), (2) the local interactive vacuum and its dynamics, and (3) the local curvatures of spacetime and their dynamics. All three components of the supersystem interact. This produces both feedback and feedforward functioning; e.g., energetic changes in the system produce corresponding changes in spacetime curvatures. In turn, the alterations in spacetime curvature produce nonlinear changes in the active vacuum, which in turn acts back upon the system. So every action in a system produces a corresponding set

of feedforward and feedback reactions from and with its complex environment, and vice versa.<sup>245</sup>

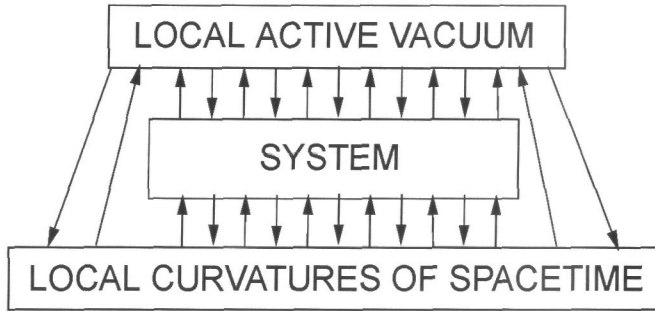

Figure 9-1 The Supersystem concept (block diagram).

Figure 9-1 shows a diagrammatic illustration of the supersystem concept. Figure 9-2 illustrates the effect of the classical EM assumptions of a flat spacetime and a locally inert vacuum. As can be seen, the classical assumptions *arbitrarily discard the* interaction effects upon and in the system due to the active vacuum dynamics and due to the local spacetime curvatures and their dynamics.<sup>246</sup>

As stated, all three components of the supersystem interact with each other. This is a dramatic change to classical U(1) electrodynamics. Hence the total interactions — with the system — of both the active vacuum and the locally curved spacetime, and their interactions with each other, are more general than either classical EM, general relativity, or the quantum mechanical vacuum of particle physics prescribes individually.

<sup>245</sup> We hypothesize that the feedback contains the mechanism generating Newton's third law as a restoration of symmetry, but leave that to the master theorists to explore and decide.

<sup>246</sup> As one example, the nondiverged Heaviside component of energy flow — previously discussed in earlier chapters — is part of the supersystem activity. This **flow** alters both the local active vacuum and the local spacetime curvature associated with an electrical power system and its connected external circuits. Since the resulting local "environmental" changes in the supersystem are extensive, then one can conceive ways in which these changes can be interacted with additional intercepting/receiving systems to produce extra "EM energy from the vacuum".

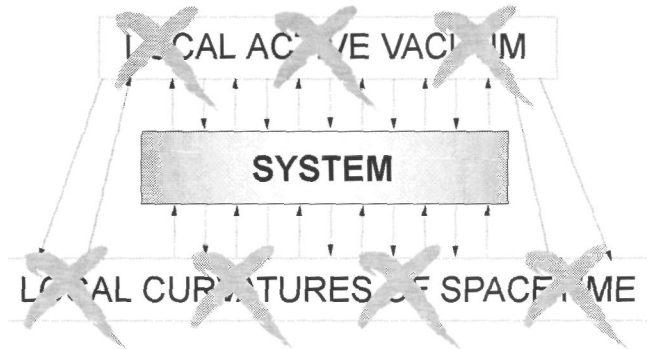

Figure 9-2 Classical EM destroys two-thirds of the supersystem.

Immediately it can be seen that the concept of energy from the vacuum is a "supersystem active and not negligible" concept involving a unified field theory approach *a priori*. It can also be seen that a "system" in equilibrium must be in equilibrium with its active environmental exchange — its exchange with the active local vacuum and the active local curvatures of spacetime. Since energy "exchange" with the system means both incoming and outgoing exchange, it follows that the equilibrium system has equal incoming and outgoing energy exchange. It follows that the symmetrically regauged system has equal incoming and outgoing energy, and so the symmetrically regauged system must be in additional stress from two net equal and opposite direct interaction forces, one general relativistic and the other from the active vacuum. Further, this "equal and opposite" equilibrium stress state must be accompanied by equal and opposite interaction effects between the two environmental media of the system.<sup>247,248</sup>

<sup>247</sup> We point out but do not pursue the fact that this is a very important new concept associated with *coherently* changing the symmetrical regauging, which allows a new physics, a new electrodynamics, and a new chemistry including biochemistry. For one thing, it permits such things as a self-maintained excitation state that simultaneously continuously discharges its excitation energy. This is simply a redefinition and more general broadening of the "source charge" concept. From the normal system view (assuming away the vacuum and curved spacetime interactions), an "impossible" system state can nonetheless be possible and stabilized, by changing the *intensity* of the Lorentz regauging condition. As an example, new molecules or ions can be made and stabilized in an excited state, that otherwise would be so unstable that the excitation would decay in a nanosecond with the state disappearing also. We believe this alone will lead to a great new biochemistry and medical

### 9.1.2 Time and Space Effects and Positive and Negative Energy

From curved spacetime considerations, we must include the effects on the system, and on the vacuum, of dynamics in the *time* domain as well as in the *spatial* domain. Indeed, in Sachs's theory space and time do not separately exist, but only spacetime. We consider time as highly compressed EM energy — as heretofore pointed out, where time is spatial EM energy compressed by the factor  $c^2$  and having energy density similar to mass. We must include not only EM *energyflow* along the time-domain (fourth Minkowski axis *ict*), but also EM *force, potential, energy oscillations*, etc. in the time domain itself. We shall have to deal with time-force, time-energy, time-potential, time-energy current, longitudinal EM waves in the time domain (time-polarized EM waves), etc. {563}. The complexity of the full supersystem analysis is thus easily seen and appreciated. In most cases, a higher group symmetry model for a particular situation will prove intractable for closed solutions, and numerical methods must be used.

Further, when curved spacetime interacts with the active vacuum, we shall also have to consider *negative energy* currents in the nonlinear vacuum itself, as well as in the time-domain. We may also speak of the *negative energy density* in the vacuum as a special kind of negative energy *potential* in the vacuum that is created by a negative energy potential in the time domain. We may speak of a gradient in this vacuum negative energy potential as a negative energy force or "force in the negative energy domain". Applied to the time domain, these concepts constitute a causality condition placed on the Dirac sea, in the same vein as more technical causality considerations given by Finster {564}.

## 9.2 Differences between Effects in COP»1.0 and COP<1.0 EM Systems

In this chapter, we utilize the Dirac hole in a different manner from the received interpretation. The received interpretation assumes an electron hole in the vacuum, with the hole filled with a negative energy electron

therapeutic science; one company is already working in this area, with positive results.

<sup>248</sup> We leave to the advanced theorists the connection between this "stable equilibrium state under a change in symmetrically regauged stress", occurring as a *net-force-free* intensity change in the conventional Lorentz symmetrical regauging of the Maxwell-Heaviside equations.



having negative mass, negative energy, and negative charge. In that interpretation, when the electron is lifted out of the hole, the hole is said to be a *positive energy* electron with positive mass and positive charge, (i.e., when interacted and observed). In short, with reaction one has a complete transformation of negative energy into positive energy, negative mass into positive mass, etc. In our view, this totally destroys the notion of "how the hole exists in the vacuum prior to its interaction and observation". That kind of positron only occurs after a physical interaction and observation has occurred — in short, *the positron exists only after an interaction with the Dirac hole has been made, to change the very nature of the negative energy hole*. The positron is the 3-effect of an invoked extra 4-interaction, and is not at all the "negative energy electron" or hole as it actually exists prior to being interacted and transformed. The positron is a different beast from the beast we wish to harness and use. The conventional interpretation leaves the question of the unobserved and unreacted "hole" left behind by an electron lifted out of the hole, before another interaction is performed on the hole to change it. So it is an incomplete accounting (as all observations are).

In our interpretation, the Dirac "hole" in the vacuum is itself the true negative energy electron before its interaction and observation. It is the "causal" 4-space negative energy electron, while the received interpretation is only for the "observed" or "effect" positron. In our view, the received interpretation thus leaves out a goodly part (and the most interesting part) of the Dirac sea hole. When the negative energy hole is filled, we consider the *electron* in the hole to be a normal, positive energy, positive mass electron. Hence the summation of the energy of the filled hole is zero, as is its summation mass and its summation charge. This accords with the properties of the "normal" vacuum, said to contain a sea of such "filled Dirac holes".

Our purpose is to use *emptied* Dirac sea holes before their interaction or observation, and thus to use them as *causal 4-electrons having negative mass and negative energy, but where each of those quantities is multiplied by time*. So the hole has *negative masstime and negative action*. Unless otherwise stated, that is our interpretation of a Dirac sea hole, and that will be how we use it. This way we avoid having to replace a true negative energy, negative mass, positive charge causal (unobserved) 4-electron by a positive energy, positive mass, positive charge observed (effect) 3-electron. We do not just artificially "dispose of" the question of the "nature of the hole that is left behind" when the positron is observed. We

consider the (hole x time) as the fundamental negative energy 4-electron. We will sometimes refer to that as the "4-positron".

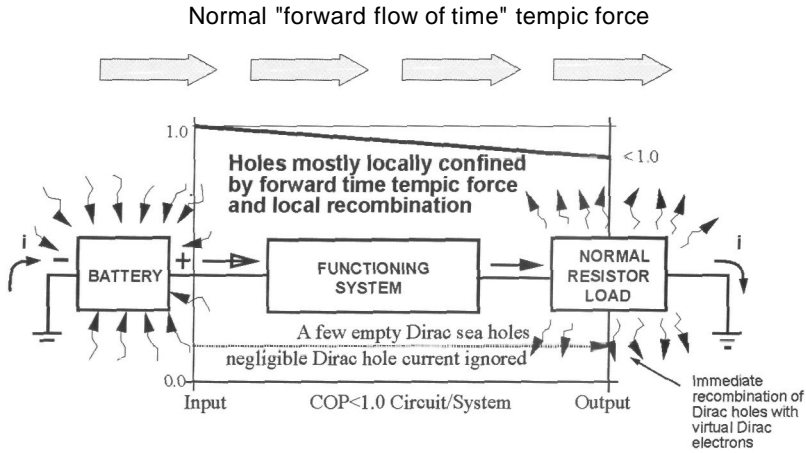

Figure 9-3 Time potential gradient across a COP < 1.0 EM system.

See Figure 9-3. In a COP < 1.0 EM system, the tempic potential gradient (tempic force) is oriented from input to output and on out beyond the system. A very slight Dirac hole current moves outward from the output, but is immediately "eaten" by the virtual electron flux fluctuations of the vacuum in the space immediately adjacent to the output. There is a slight Dirac hole current also exiting the system in its losses, but again these are immediately "eaten" by the virtual electron flux fluctuations of the vacuum in the immediately surrounding space.

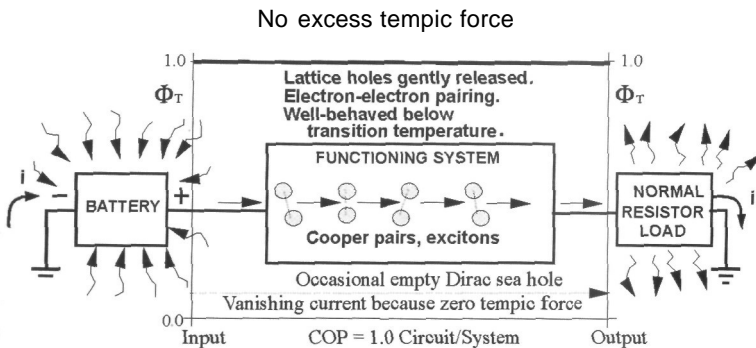

Figure 9-4 Time potential gradient across a COP = 1.0 EM system.

See Figure 9.4. In a superconductive system or section,  $COP = 1.0$  and on the average there is no net tempic force across the system, hence no time-force across it in either direction. Accordingly, one sees ready Cooper pairing of charges and formation of excitons. We shall not concern ourselves further with the superconductive EM system; such a system has not yet produced  $COP > 1.0$ .

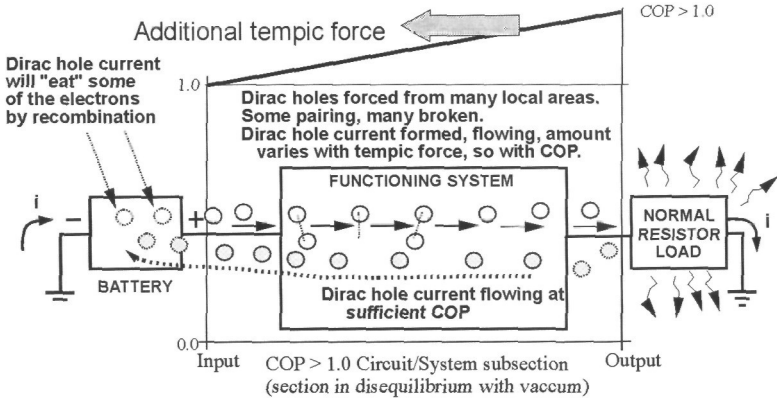

Figure 9-5 Time potential gradient across a  $COP \gg 1.0$  EM system.

See Figure 9.5. In a  $COP > 1.0$  EM system, there is a net tempic force across the system from the output section to the input section. However, unless the  $COP \gg 1.0$ , the hole current in the local vacuum is mostly used up in interacting with the system material and converting to lattice holes (lattice positrons). Hence at "nominal" or moderate  $COP > 1.0$ , except in fast pulsed discharges one *usually* has little to worry about, concerning Dirac sea holes in the vacuum, since those readily convert to lattice holes as already accounted. One effect of concern is that, if the semiconductors in the system are exposed to sufficient extra lattice holes or interacting 4-holes, their donor-acceptor arrangement is disrupted, spoiling the action of the semiconductors and perhaps destroying them.

When  $COP \gg 1.0$  (and even for some  $COP > 1.0$  systems), then there results a substantial Dirac sea hole current in the local vacuum occupied by the system, flowing through the supersystem from the output section back to the input section. This is an additional hole current component from the

Dirac hole current component converted into lattice hole current.<sup>249</sup> This unconverted Dirac sea vacuum hole current runs through the system from the output section back to the input section of the system and beyond. If not "filled" there in the input section by the incoming input electrons from the external power supply, the 4-hole current can and will pass on back into the feed line and to the distant external power supply, *eating electrons and electron current all along the way*. Usually semiconductors in the path of a substantial 4-hole current will either malfunction or be quickly destroyed.

In the input section and on back into the external power source, the effect of the unrestrained Dirac sea hole current's reaction is to interact and convert into lattice holes all along the route, which lattice holes then "eat" incoming electrons from the distant power source. Thus, the external power source "sees" the hole current as a dynamic additional load in the system's input section itself (and in the external conductors leading to it) *that also must be powered with additional positive energy electron current*.

<sup>249</sup> Here we wish to recognize the perceptivity of Peter Lindemann, who recognized the importance of "cold electricity" in COP>1.0 systems without going deeply into the more technical aspects of negative EM energy. As an example, we cite his book, *The Free Energy Secrets of Cold Electricity*, available from Clear Tech, Inc., Box 37 Metaline Falls, WA 99153, U.S.A. Particularly note his efforts to explain the Gray overunity device via the negative energy that can be associated with very strong discharges. Gray referred to this appearance of an associated negative energy component associated with the normally positive EM energy as "splitting the positive pole" (a "pole", after all, involves a stress potential). The Gray engine drawing is shown in Figure 5-14, his conversion tube is shown in Figure 5-15, and his circuit for the conversion tube is shown in Figure 5-16. As Lindemann explains, Gray also apparently succeeded in converting the negative energy into positive energy in his conversion element switching tube. Bedini's successful replication of the tube along with pertinent lab notes are shown in Figures 5-17, 5-18, 5-19, 5-20, and 5-21 by permission. Since Bedini is one of only two or three persons truly experienced in converting negative energy into positive energy, his successful replication is significant and decisive. Gray's process thus transformed negative energy into positive energy, allowing positive energy COP>1.0 self-powering systems. Bedini and the present author have filed a joint patent application filed on the process explained in this Chapter. We recognize Ed Gray as being a real pioneer in the area of COP>1.0 electrical power systems and in energy conversion. His pertinent patents are E. V. Gray, "Pulsed Cap. Electrical Discharge Engine," U.S. Patent #3,890,548, 1976; "Efficient Power Supply Suitable for Inductive Loads," U.S. Patent #4,595,975, **June 17, 1986**.

Aside from destruction of semiconductors etc.,<sup>250</sup> the overall effect is to increase the draw of power and current from the external source, so that the COP  $\gg$  1.0 power system is thereby converted back to a COP  $<$  1.0 system!

The increased power draw due to the Dirac hole current can be remarkable. For an external battery power supply, if the hole current is sufficient to pass on into the battery itself, the battery may *charge* with negative energy while also powering the circuit! A remarkable phenomenon then takes place. A battery having been appreciably charged with negative energy may appear to be discharged (and so it is, with respect to positive EM energy). Yet, it may also continue to power a circuit. Sometimes it will, sometimes it won't, depending on the circuit. However, on connecting a normal positive energy battery charger to recharge it, the battery *precharged* significantly with negative energy will "eat" positive energy for an extended period, filling its localized Dirac Sea holes in its negative charge all the while, with the external voltage of the battery not changing at all. When all the negative energy holes are filled in the internal vacuum environment of the battery, and the negative energy charge is thus removed, suddenly the battery will start recharging with the input positive energy in a normal manner.

The batteries in Watson's generator (again see Figure 5-12) exhibited that phenomenon. Sometimes in recharging one of his batteries that had been extensively used, the battery would "eat" positive energy from the charger for a week or more before finally filling up its negative energy charge and then recharging normally from that point on.

The Dirac 4-hole current is nature's decay mechanism for the COP  $\gg$  1.0 system, sharply bringing it back to COP  $<$  1.0. Any successful COP  $\gg$  1.0 EM system must contain a mechanism for defeating (or transducing and

<sup>250</sup> As an example, novel effects may also happen in resistors, capacitors, and coils, and the effects depend on both the materials and construction of these components. A resistor can act as a true negative resistor and cool rather than heat, a capacitor can have its current lagging its voltage, and a coil can have its current leading its voltage. Mixtures of all three of these effects can happen in each of the three components, since each usually has some aspects of resistance, capacitance, and inductance. The emfs and back emfs in the circuit can also be altered and disrupted in a manner varying with the individual circuit and the individual operating conditions. Nonlinear oscillations and discharges of negative energy are particularly difficult to foresee and understand. Effects in dielectrics may vary widely, as can effects in conductors because of their internal impurities, etc.

using) this Dirac sea vacuum 4-hole current into its input section and beyond. We shall cover that subject shortly. The 4-hole current decay mechanism can *sometimes* become significant for semiconductors in the lattice 3-hole stage at  $COP = 5$  or more, though the exact figure varies as the type and size of system and the semiconductor type. At  $COP > 10$  or so, some systems will frequently begin to ravage themselves back into equilibrium with the vacuum, and destroy their overunity performance, unless the 4-hole current phenomenon is dealt with.

Let us recap. We have assumed — to first order — a sweeping generalization that  $COP < 1.0$  systems exhibit an overall average spacetime curvature across the system (from input section to output section and load) such that excess positive energy electrons exist in the Dirac sea, without any appreciable accompanying excess Dirac sea holes interacting in the circuitry itself.<sup>251</sup> The slight excess of Dirac sea holes that are generated is "swept" forward out of the output section, and "eaten by the vacuum interaction" (particularly by the vacuum fluctuations) immediately upon exit from the output section. In that case, we do not have to concern ourselves particularly with Dirac Sea 4-holes and Dirac sea 4-hole currents, or at least they are usually negligible in most cases.<sup>252</sup>

For  $COP \gg 1.0$  systems, however, the overall average spacetime curvature across the system — from output section and load to input section — is such that Dirac sea 4-holes and their currents do independently continue to exist and independently flow in the local vacuum occupied by the physical system. Specifically, we shall have to consider the *tempic* effects upon such holes and hole currents, which are oriented from the output section back through the system to the input section.<sup>253</sup> In the  $COP \gg 1.0$ , the

<sup>251</sup> In short, the requisite number of Dirac holes have interacted with and do interact with the lattices, converting into the normal "lattice hole" type of positron connected with positive mass, positive energy, but slowly migrating around the circuit in the opposite direction from the electrons. Here the true Dirac hole current exists only in short "hops" from atom to atom as the lattice holes are steadily filled by the "hopping" electrons.

<sup>252</sup> As stated, a kind of "hole" phenomena still exists in the circuit, but now as lattice holes and currents. Since these are attached to ions each having a mass much greater than that of an electron, the lattice hole currents may usually be neglected except in semiconductors, where they are taken into account in the very design of the semiconductor component itself.

<sup>253</sup> When we state a concept such as "negative mass" or "negative energy", we have conceptualized it *as if observed*. Hence, unwittingly we have made it an instantaneous, but iterated, concept. Rigorously, no such thing as mass or energy

effect of the increased tempic force is to sweep a Dirac sea 4-hole current back through the system from output to input, and even on out into the conductors from the external power supply, and on further out into the external power supply itself. The 4-hole current continues its "reverse feedback into the powering end of things" until quenched by filling it with incoming electrons. This conversion of 4-hole current to filled Dirac sea 4-holes by induction of lattice holes also squelches the concomitant negative EM energy fields, potentials, and waves associated with Dirac 4-holes as sources.<sup>254</sup> The reason is that a filled Dirac hole is a dual system of two opposite charges, hence produces counteracting positive and negative energy fields.

The "4-hole-eating and filling process" is therefore the exact decay mechanism that squelches the natural electrogravitation associated with Maxwellian circuits which use Dirac 4-holes and 4-hole currents, negative energy fields, negative energy potentials, etc. When the circuit converts its free Dirac 4-holes into lattice holes, all electrogravity capability is lost, insofar as practicality is concerned.

For electrical power system purposes, the external environment of the COP»1.0 system furnishes an extra "electrical load" demand upon the external power supply, so that the extended system consisting of the (external power supply + power system) decays back into overall COP<1.0 condition and operation. For this reason, any appreciable involvement of Dirac 4-hole currents in a COP>1.0 EM power system must be *transduced* into positive energy electron currents, which requires just a special form of regauging. One need not confine regauging and gauge freedom to positive energy potentials and positive energy fields alone.

From the vacuum consideration and particularly from Dirac's theory of the electron, in COP>1.0 EM systems and circuits we shall consider that the Dirac sea 4-holes involve negative energy states (negative mass), and that positive energy states involve positive mass. In our approach, we shall consider a negative energy state (Dirac 4-hole) in the vacuum as having

independently exists except at one instant in time. Instead, mass exists in a continual iteration of  $m \rightarrow mt \rightarrow m \rightarrow mt\dots$  and energy exists in a continual iteration of  $E \rightarrow Et \rightarrow E \rightarrow Et\dots$  and so on. So during the masstime or energy-time (action) state, time and either mass or energy are intimately interactive. See our previous discussion in this book of the mechanism for the flow of a mass through time.

<sup>254</sup> Obviously that kills the antigravity aspects, because it kills the negative energy fields that would give negative curvature of local spacetime.

negative mass, which means that antigravity can be involved as well.<sup>255</sup> In this treatise, we consider only electron states, thus only negative energy and positive energy electron states.

### 9.3 Primarily Concerned With Dirac Sea Holes and Not Lattice Holes

We also stress the dramatic difference between a Dirac sea "electron 4-hole" in the vacuum (prior to observation) as compared to a lattice 3-hole in a semiconductor or other material component (after interaction and therefore after observation). In the case of a lattice 3-hole, usually the "positron" (hole) is attached to an ion, whose mass (i) is very much greater than the mass of an electron, and (ii) is also positive. In other words, a lattice hole is just a part of an ordinary positive ion. So the theory of "lattice holes" and "lattice positrons" does not primarily apply to the situation we are discussing. On the other hands, semiconductors exposed to any significant currents of pure Dirac sea 4-holes in the vacuum usually react and are nearly instantly destroyed because of the immediate disruption of their donor-acceptor arrangement and functioning. Interaction (filling the incoming Dirac 4-holes with contributed electrons) causes sudden mass disarrangements in their atoms and nuclei and lattice

<sup>255</sup> We assume that the important thing about mass is its localized energy. Hence we associate positive mass with positive localized energy (with respect to the ambient energy density of the massless vacuum) and we associate negative mass with negative localized energy (with respect to the ambient energy density of the massless vacuum). In this view, the empty Dirac sea hole has both negative energy and negative mass. Note that this differs from the conventional assumption, which unwittingly addresses the positron as having been observed, producing a directional reversal. The rigorous test of our thesis is that concentrations of Dirac sea holes *must* generate antigravity *potential*, while currents of Dirac sea holes must generate antigravity *force*. The conventional view, assigning positive mass to the positron after observation, would produce gravity, not antigravity, but the force would be reversed by the reversed parity after observation. We argue that antigravity has been hidden and lost by its parity reversal in the assuming positive mass for the positron *as if that were the mass of the positron before it is observed*. In an overunity system with powerful steady-state Dirac 4-hole currents, the 4-hole currents can be differentiated by the cooling (negentropy) effect of the COP $\gg$ 1.0 system—when shorted to produce a "current surge" — rather than heating (entropy) effect. The magnitude of the hole current (which determines the average presence of the hole density) can be differentiated by a measurable weight loss in the COP $\gg$ 1.0 system. The successful antigravity production of the Sweet COP $\gg$ 1.0 device — discussed later in this chapter — experimentally verified these hypotheses.



bonds. Thus, in the presence of Dirac sea 4-holes and 4-hole currents, usually any interacting solid-state electronics of the circuit or system will be dramatically affected. For switching in the presence of holes and hole currents, in most cases one may have to turn away from semiconductors and utilize mechanical or electro-mechanical switching, although this requirement varies with the type of semiconductor, the COP, the system geometrical layout, and the subsystem operations and layouts. Sometimes semiconductors may still be used if they are "brutes", with current handling capabilities well beyond what is "normally expected" in that circuit.

## 9.4 Peculiarities of Spacetime Curvature and Dirac Hole Interactions

When considering the interaction between *curved* spacetime and the Dirac vacuum, immediately we violate the premise that all electron states in the Dirac Sea are always filled (which condition we surmise — along with Dirac — only exists on the average in a flat spacetime region). In a curved spacetime, we can have sustained excess 4-holes in the vacuum, or we can have holes that accept an electron falling into them *without emitting radiation*. The radiation-free "pair annihilation" reaction is possible when the spacetime simultaneously changes its curvature appropriately and thereby "absorbs" and holds the excess EM energy that would otherwise be emitted if the spacetime remained flat or decayed back to the flat state.<sup>256</sup> So long as that "energy-storing ST curvature" remains, there is no photon energy emission. If the "energy storing ST curvature set" has a net curvature instead of being flat, and then decays to a flat spacetime, then the previously retained energy is emitted as photon energy.

In that case the reaction provides the conventional emitted pair annihilation energy. In *that* case, the emitted energy may also transform into emitted particles in reactions well known in particle physics.

<sup>256</sup> Eerily, this interaction represents a situation where opposite reaction forces (the vacuum upon spacetime, and spacetime upon the vacuum) can create a special kind of stress in the system and changes in that stress. This leads to a peculiar kind of stress waves (scalar waves — longitudinal EM waves, so to speak) that are not covered in circuit theory anywhere. A symptom is that these stress waves react with components, amplifiers, preamps, etc. to create electrostatic waves. The effect of these waves is seen as the "crawling" of electrostatics all over and in the electrical equipment that is in one's laboratory. The effect can readily damage oscilloscopes, etc.

The normal emission of photons by pair annihilation need not occur, if the excess decay energy is absorbed *and held* by the local spacetime changing and holding its energy density and therefore (i) changing its curvature and (ii) stabilizing in that new excited state instead of decaying back to a flat spacetime.<sup>257</sup> Under such "non-emitting" pair recombination, a Dirac Sea 4-hole may simply "eat" a free 4-electron, and instead of emitting radiation the process simply affects the curvature of spacetime (and the state of the local Dirac sea) and changes it accordingly. A new "equilibrium state" is therefore reached in the supersystem between the opposite forces of the vacuum acting on spacetime and spacetime acting on the vacuum.<sup>258</sup> In other words, we consider change in the curvature of spacetime to exhibit EM energy *source* (emission) or *sink* (absorption) capability, with respect to the nominal ambient flat spacetime and with respect to conventional EM interactions.<sup>259</sup>

Or simply put, the energy emitted by the combination of positive and negative energy in the vacuum may be "locally radiated", "locally absorbed", or "locally transferred" to the other local component of the supersystem: the local curvature of spacetime. *It is all spacetime curvature dynamics.* By definition, a flat local spacetime consists of a vacuum with all its Dirac sea holes filled. Therefore, if "filling a 4-hole" results merely

<sup>257</sup>Our view is that in normal pair annihilation this curving of spacetime to absorb the emission energy occurs first, and then the new ST curvature decays by what is called "emission of photon energy". We regard the photon as a specialized ST curvature traveling at light speed. So what is emitted as a photon is in fact the formation of a locally structured spacetime curvature (an "engine") traveling at light speed. It is a propagating spacetime curvature "engine" or "set of engines". In the process we are describing, the emission of the photon is the decay of the locally formed ST curvature set. If that set does not decay, the locally formed ST curvature set remains and no photon is emitted.

<sup>258</sup>This new kind of equilibrium is extraordinarily important, particularly in chemistry, where it will allow the "locking" of impossible combinations of particles into strangely stable "impossible molecules" with ongoing "impossible chemical reactions". The further discussion of the startling new chemistry that emerges is well beyond the scope of this paper, but such chemical states are included in nonequilibrium thermodynamics as *stationary states* — e.g., see Kondepudi and Prigogine, *Modern Thermodynamics*, Wiley, 1998, Chapter 17. At least one company has already succeeded in initiating this startling new kind of chemistry, with several patents granted and several more in process. Similar new "impossible stabilized excited states" and "impossible nuclear reactions" also occur in nuclear physics.

<sup>259</sup>The classical EM assumption of the flat local spacetime is in fact an assumption that the decay of the intermediate "ST curvature absorber/sink" occurs instantly.

in relaxation of a set of local ST curvatures back to a flat spacetime, no EM radiation need be emitted, contrary to the usual pair annihilation phenomenon where additional energy (curvature of spacetime) is involved.

Similarly, in a ST curvature, there can conceivably be electrons without "holes". If the curvature is negative, there *will* be unfilled Dirac sea holes present. Of course this is just a normal positive energy 4-electron, where the flat spacetime assumption in classical electrodynamics is in error. Instead, the local spacetime is positively curved, producing positive gravity. Whenever the energy density of spacetime-vacuum interaction changes from the "ambient vacuum and flat spacetime" condition, either positively or negatively, that constitutes an appropriate curvature of spacetime as well as a change in the vacuum dynamics. Therefore, in classical electrodynamics the assumption of a normal electron (or any other charge or mass) existing in an uncurved spacetime and an unaltered vacuum is a non sequitur. The local spacetime has in fact "curved" to an extent of holding the energy of one electron mass.<sup>260</sup> Further, the Dirac Sea has also changed to contain one unfilled and unobserved Dirac 4-hole.

With these things in mind, let us now introduce a conceptual model for dealing with these novel 4-hole phenomena that are experienced in COP>1.0 systems — and that have been the bane of many a would-be energy researcher attempting to develop a system extracting its EM energy from the vacuum and using it to also power the system itself.

## 9.5 Charging and Discharging a Capacitor

In electronic circuits, we usually think of charging a capacitor with electrons, and then discharging the capacitor to emit electrons again. However, we can charge the same capacitor with Dirac sea holes, or with a combination of Dirac sea holes and electrons. Then we can switch the capacitor adroitly and force it to give us back electrons. This "regauging" effect can thus be used to transduce negative energy current into positive energy current. So let us examine the charging and discharging process more closely. This is part of the Bedini process for handling the 4-hole

<sup>260</sup> Mostly physicists think only of the *spatial* energy change. However, the time domain of spacetime also acts as a sink or source. Essentially one kilogram of mass only has the energy of 1 second of time. Hence the minuscule *mass* of the electron results in such a minuscule "sink" in the time domain that it has been inadvertently ignored. However, during that fraction of time where the electron exists as "mass time" and "charge time", it has considerable time energy, and *that* curvature of local spacetime cannot be neglected with respect to supersystem interactions.

current problem in overunity EM systems, to allow close-looping a system into self-powering operation.

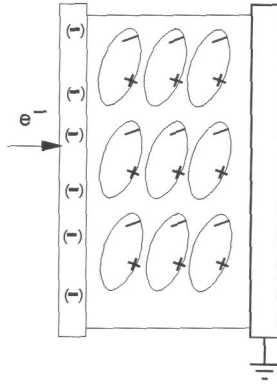

Figure 9-6 Normal strain in a dielectric capacitor that charges with electron current

Figure 9-6 shows the normal strain induced in a capacitor containing a dielectric between its plates. We charge the left plate with electrons, which repel the negative ends of the molecules in the dielectric, straining them to the right.

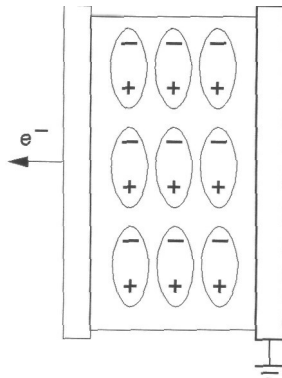

Figure 9-7 Strain relief in a charged dielectric capacitor that discharges.

Figure 9-7 shows the relief of this dielectric strain, by allowing the piled electrons on the left plate to be pushed back into the circuit from the left plate. Note that the electrons emitted in the relaxation of the dielectric strain pass back into the circuit from the same plate that was charged. This is a special kind of "reflection" symmetry. For a perfect capacitor, the total

$Vq$  joules stored in the charged capacitor and drawn from the circuit, is returned to the circuit.

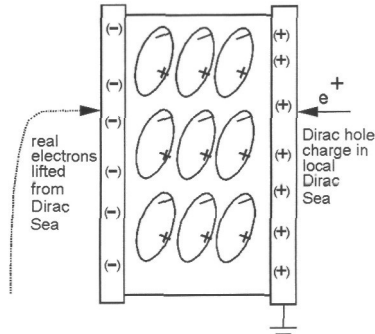

Figure 9-8 Strain in a dielectric capacitor supersystem that charges by Dirac hole current and lifted Dirac electrons

Figure 9-8 shows a remarkable thing when we charge the capacitor with Dirac sea holes. Suppose we charge the rightmost plate of the same capacitor used before, while the leftmost plate is temporarily disconnected from the circuit (or connected to another capacitor). Now Dirac Sea holes pile up in the local vacuum connected with the right plate. Whether or not they interact with the right plate, these positively charged holes attract the negative ends of the dielectric molecules, again straining the top of the dielectric molecules to the right. The strain of the dielectric is a force interacting upon the local vacuum, and it lifts real electrons from the Dirac Sea (or pulls them from the circuit or other attached capacitor) and onto the leftmost capacitor plate. The charged capacitor *in its supersystem* thus has additional functions that occur. The total  $Vq$  joules stored in the charged capacitor, were this time drawn (converted) from the applied Dirac hole current and the resulting interaction upon the vacuum, to lift real electrons onto the leftmost plate.<sup>261</sup>

<sup>261</sup> The reader should recall that a force is something automatically produced by nature to restore symmetry to a broken symmetry condition. A "4-hole negative energy force in the Dirac Sea" produced on one plate of the capacitor will evoke a "positive energy force outside the Dirac Sea" on the other plate as an attempt to restore symmetry. To produce this "positive energy force", positive energy electrons are lifted from the local Dirac Sea of that plate.

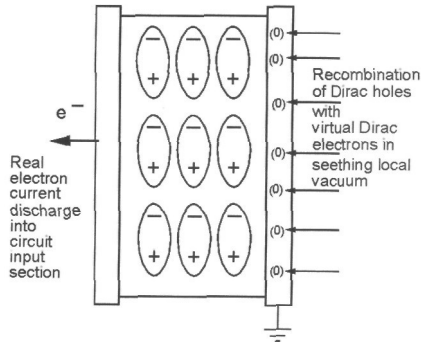

Figure 9-9 Strain relief in a dielectric supersystem that discharges after charging by Dirac hole current and lifted Dirac electrons.

Figure 9-9 shows the strain relief of the charged capacitor in Figure 9-8. First the charged capacitor is re-connected to the circuit or element to which one desires to provide with electron current. The strained dielectric relaxes, and electrons in the leftmost plate are returned to the circuit. The Dirac holes in the rightmost plate discharge back into the local vacuum (a supersystem interaction) and are "eaten" immediately by the readjustment of local curved spacetime.<sup>262</sup>

The result is that the Dirac sea 4-hole current arriving in the input section has been intercepted by a waiting capacitor, and has been effectively transposed into normal electron current that is furnished back to the input section from the capacitor. This additional electron current helps power the circuit and reduces the power drawn from the external power source. The 4-hole current feeding this capacitor, together with transduction of the 4-hole current into electron current, effectively comprises a true negative resistance process. In other words, energy in unusable (in this case, detrimental) form is received, transformed into energy in usable (beneficial) form, and that usable energy is discharged back into the circuit input to assist in powering the system.

Transducing negative energy into positive energy — and vice versa — in the system does not violate the conservation of energy law in the

<sup>262</sup> From experiments, it seems that Dirac holes forming at the "output" section of a  $COP < 1.0$  device or system are almost instantly filled with electrons in the violent fluctuations of the zero-point energy. When forming at the "input" section of a  $COP > 1.0$  device, this is not the case, and usually the holes can only be filled by incoming electrons in the power input, unless special provisions are taken to convert the arriving hole current (in the input section) into electron current.

supersystem, when most generally stated. With such regauging (which involves supersystem reactions), it is the *absolute value* of the energy that is conserved in the system, not its algebraic sign. Regauging (by gauge freedom) is after all an effect or condition locally imposed, but with appropriate energy exchange with the rest of the external universe via spacetime curvature dynamics exchange and vacuum dynamics exchange. The algebraic sign *is* conserved in the universal supersystem by the additional compensating reactions occurring in the other two components of the universe's supersystem.

The reader should strongly realize that energy is only required to be conserved in the universe's supersystem, not the system component alone. Again, this is an open system far from equilibrium with its active environment. In that case, energy is conserved in the ensemble of system and environment, but not necessarily in the system itself. This is no stranger than a common windmill or waterwheel.

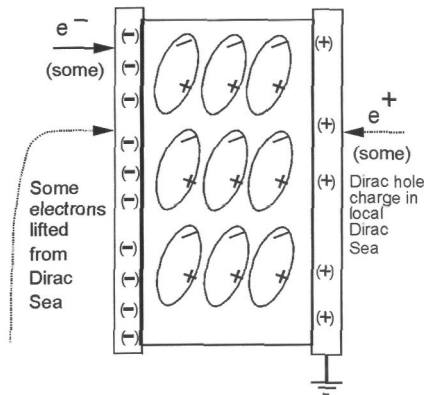
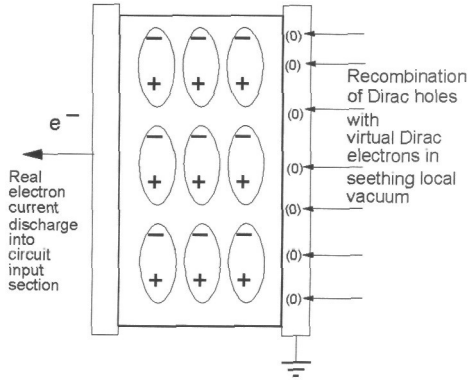

Figure 9-10 Strain in dielectric in a capacitor supersystem that charges with a mix of electron current, Dirac hole current, and lifted Dirac electrons.

Figure 9- 10 shows a "mix-charging" variant of the 4-hole current charging of a capacitor, in which some real electrons are fed from the circuit to the left plate. Also, the Dirac sea hole current arriving in the input section is intercepted to charge the right plate, and some electrons are also freely lifted from the local Dirac Sea onto the left plate. Figure 9-11 shows the discharge of this type of charging of the capacitor, and the relief of the strain in the dielectric.



**Figure 9-11** Strain relief in a dielectric that discharges after charging of capacitor supersystem with mix of electron current, Dirac hole current, and lifted Dirac electrons.

In Figure 9-11, for example, we accent that the holes on the right plate are maintained only so long as there is a net strain on the dielectric and a net force across the capacitor. When the capacitor is discharged, the holes are discharged into the local vacuum in such a way that they now instantly recombine with virtual Dirac electrons in the vacuum fluctuations.

There are other ways and "tricks" of transducing the Dirac sea hole 4-current into electron current, but these methods are still proprietary to Bedini and will not be included in this presentation. We accent that all such "tricks" are actually methods of re-engineering the other two components of the supersystem — the active local vacuum and the local curvature of spacetime. This is using and applying what we have referred to as "engines".

## 9.6 The Open-Loop COP>1.0 EM Power System

Figure 9-12 shows the use of the transduced Dirac hole current as real input energy to "catch and lock" a COP>1.0 system in its overunity condition and stabilize its operating point for stable self-powering of the system and its load. The COP>1.0 operation reverses the normal tempic potential across the system, so that Dirac hole 4-current arrives in the input section, preparing to "decay" the system back to COP<1.0 condition.



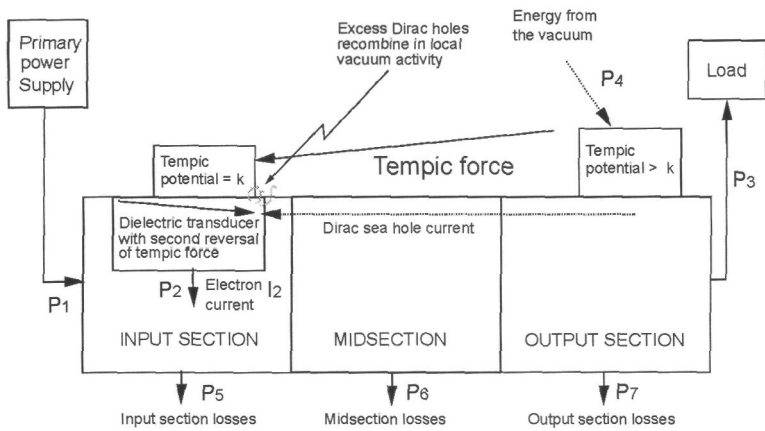

Figure 9-12 Open-loop use of transduced Dirac hole current energy as real input energy to reduce power input required from the primary power supply.

However, the arriving hole current is intercepted by an adroitly switched dielectric transducer, which again reverses the tempic force. As explained above, the capacitor is charged with 4-hole currents (or a mix) and then discharges electron currents into the system — in this case, into the input section itself— by adroitly engineering the local vacuum state and the local curvature of spacetime.

The input section does not care where it receives its electron current from; it merely needs sufficient for its powering needs. Hence, the input section happily accepts this transduced electron current to partially power the system. This in turn reduces the "system load" that the external primary power supply "sees". The primary power supply thus reduces the current and power that it is furnishing to the system. In short, now the external power supply sees the combination of the normal system load and a "negative resistor (negative load)" represented by the transduced current and power. Its required input power is reduced accordingly.

### 9.6.1 Close-looped System: A True Negative Resistor

Figure 9-13 shows the use of the same process given in subparagraph 9.6 above and in Figure 9-12, except that now there is additional 4-hole current received and available, for transduction into normal electron current into the input section of the system. Sensors and governing are added to this operational mode, so that the system may *adjust and regulate its self-furnished electron current* to meet the total needs of its losses and

its load. The system thus adapts the transduction of Dirac sea hole current: to fit its needs and is capable of regulated self-powering operation.

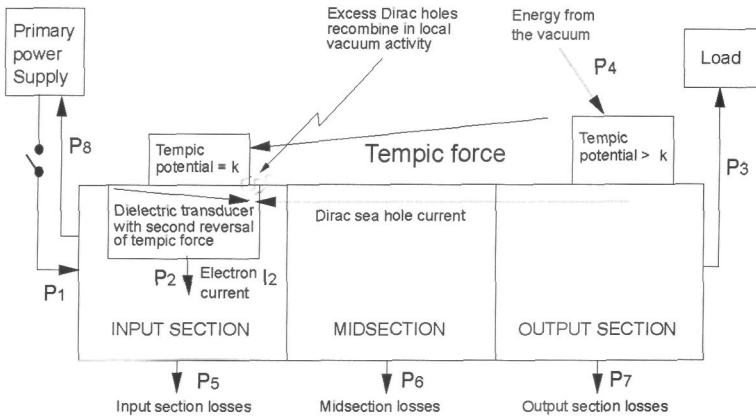

Note: Power outputs P3 and P8, and current I2 have sensors reporting to the Governor in the output section. The governor adjusts the potential energy in the output section to maintain steady output or adjustment of output to demand.

**Figure 9-13** Close-looping the COP>1,0 system with transduced hole current.

The system is first started in open-loop mode. The governor then gradually increases the transduction of 4-hole current into electron current, and the supply of that transduced electron current to its own input. This steadily reduces the "current draw" from the external primary power supply. When the "external current draw" reduces to zero (the Kron condition), the system "locks" into that position, with automatic governing to adjust the transduced electron current as the loads and losses vary. At that point, the external power supply is disconnected automatically.

This "locked and governed" system is now a *self-powered system*, freely taking its energy from the active vacuum and local curvatures of spacetime, to power both itself and its load. So far as we are aware, this is the first time that the technical means of locking and stabilizing COP>1.0 operation in an EM system in an open loop and closed-loop operation has been given.

If sufficient Dirac sea 4-hole current is available and transduced, excess electron current can be available at the system input section, even when the system is fully self-powering. In this case, the additional current can be fed back to the power line, so that the self-powering system not only powers its own load but also helps power the power network. Or additional load can be added and powered.

We point out that Gabriel Kron apparently had a solution to these problems in the late 1930s, and that solution has been suppressed to the present day. We give the following quotations to show Kron's knowledge of these things.

Quoting Lynn and Russell {565}:

*"Kron has never published details of his method of making the polyhedron self-organizing, although his published results show that in this state it has some remarkable properties, associated with harmonic integrals on multiply connected spaces."*

In reference to Lynn and Russell's remarks, we point out that the Dirac sea 4-hole current from the output to the input is a special case of Kron's more general discovery of the multiply-connected open path existing through space between any two points in a circuit that are at differing potentials.

Quoting Kron {566}:

*"...the missing concept of "open-paths" (the dual of "closed-paths") was discovered, in which currents could be made to flow in branches that lie between any set of two nodes. (Previously—following Maxwell - engineers tied all of their open-paths to a single datum-point, the 'ground'). That discovery of open-paths established a second rectangular transformation matrix... which created 'lamellar' currents... " "A network with the simultaneous presence of both closed and open paths was the answer to the author's years-long search."*

Again quoting Kron {567}:

*"Although negative resistances are available for use with a network analyzer, in practice it is more convenient to use a second type of circuit, in which the positive and negative resistances are replaced by inductors and capacitors and the dc currents and voltages are replaced by ac currents and voltages of fixed frequency. The use of the second type of interpretation is equivalent to multiplying the wave equation by  $i = \sqrt{-1}$ ."*

The reader should particularly note that in the first part of the sentence Kron stated unequivocally that negative resistances were available for **use** on the network analyzer, a large analogue simulation used by the Navy **and**

administered at Stanford University with the contractor being General Electric. The sensors missed that one.

Again quoting Kron {568}:

*"When only positive and negative real numbers exist, it is customary to replace a positive resistance by an inductance and a negative resistance by a capacitor (since none or only a few negative resistances exist on practical network analyzers).*

We believe the censor caught this one, and forced Kron to add the words, "none or". Kron had at least three negative resistors, and possibly more.

Again quoting Kron {569}:

*"Now a value  $E$  of the negative resistances, at which the generator current becomes zero, represents a state at which the circuit is self-supporting and has a continuous existence of its own without the presence of the generator, as the negative resistances just supply the energy consumed by the positive resistances. ... When the generator current is positive the circuit draws energy from the source, and when the current is negative the circuit pumps back energy into the source. At zero generator current the circuit neither gives nor takes energy, and theoretically the generator may be removed. "*

Here we believe the censor forced Kron to add the word "theoretically". In this quotation Kron reveals that he was well aware of the process for close-looping a system — starting it in open-loop mode and bringing the negative resistor currents up to match the system needs and reduce the generator current to zero, then disconnect the generator. He also was quite aware that excess transduced energy from the negative resistor could be available at the input, in which case energy could be furnished back to the power network while the system powered itself and its load simultaneously.

We also point out that Dirac's definitive electron theory — covering the Dirac Sea and Dirac sea holes — was published in 1930, the year the present author was born. In the late '30s and in the 40's Kron certainly was well aware of that work. In addition, Kron applied full general relativity to electrical circuits and machines, and he was far ahead of his time. His work is also still far ahead of the present time, at least in the open

scientific community. He also was aware of developments in particle physics, and so he did have the gist of the supersystem concept in his mind {570}, however he may have thought of it. His concept of the "open path" effectively includes the effects upon the system from the other two components of the supersystem, so it appears that Kron's "system plus its open path" roughly corresponds to our concept of the "supersystem."

Further, Kron was a mentor to Floyd Sweet, who also worked at General Electric but in a different project. Sweet often spoke glowingly of Gabriel Kron.<sup>263</sup> Sweet almost certainly knew the secret of Kron's negative resistor. It is the present author's opinion that Sweet's vacuum triode amplifier was derived from Kron's negative resistance unit. With both deceased, we will never know for certain.

### **9.6.2 Suppression of COP>1.0 Systems Should be Investigated**

During our decades of research, we ran across several cases where U.S. scientists actually produced working COP>1.0 systems.<sup>264</sup> None of these overunity systems was ever allowed to go forward with independent development. This is an area that cries out for a full and vigorous Congressional investigation, and appropriate legal action should be taken by the U.S. government against the suppressing parties, whomever they might be {571}. Simply put, the U.S. government, the U.S. taxpayer, and the scientific community have been ripped off and deluded in the field of electrical energy for more than half a century. That continues to the present, as witness the disappearance of the Watson generator (accompanied by Watson and family breaking off all contact with their close colleagues) and the suppression of the Kawai device and process. The latter suppression was accomplished in 1996 in the personal presence of the present author and the members of the Board of Directors of our company, CTEC, Inc. An accidental overunity frequency converter was even initially placed in the original Minuteman missile, but was altered back to COP<1.0 operation when the electronics past the converter kept failing because of overload power furnished by the converter.

<sup>263</sup> The present author worked with Sweet off and on for a decade or more, and designed the antigravity experiment that Sweet performed.

<sup>264</sup> These incidents were previously exposed in a draft book, *Matters Arising*, carried on the Internet for some months and then withdrawn. Some things must wait for their appointed time, and so must certain kinds of information.

## 9.7 Remarks on Dirac Sea Holes, Currents, and Negative Energy

The subject of the Dirac Sea, Dirac holes, Dirac hole currents, and negative energy still has elements of strong disagreement within the scientific community and among leading theorists. Often the "conclusion" one reaches depends on the way the starting assumptions are made and then on how the mathematics is applied. There is no definitive experiment establishing that negative energy cannot exist; to the contrary, many things do occupy negative energy states. The binding energy of the nucleus, e.g., involves a loss of mass (loss of positive energy) and hence involves negative energy states, as is well known. Here the "negative mass" effect is immediately and experimentally verifiable, and is recognized. The total mass of the bound nucleons is less than the total mass of those same nucleons when unbound, and this fact is widely known and accepted.

A single white crow is sufficient to prove that not all crows are black. Hence a single experimental proof of mass-energy "loss" and negative energy states establishes that negative energy and negative mass are real. Indeed, every photon absorption by mass and every photon emission by mass prove the same point universally: mass is a variable. The same assembly of protons and neutrons in a nucleus, having lost mass, also has "lost" some of the gravity that the positive masses of those unbound protons and neutrons would otherwise produce. Therefore, there is an appropriate amount of "negative gravity" already acting in conjunction with positive gravity, in every atomic nucleus. It is associated with the negative energy states of the bound nucleons in every nucleus.

Consistent with the initial quotations and comments at the beginning of this chapter, we present an interpretation by which we can understand some of the major novel phenomena that arise in laboratory experiments with  $COP > 1.0$  electromagnetic systems, including  $COP \gg 1.0$  systems.

We propose that  $COP \gg 1.0$  EM interactions are widespread in highly energetic astronomical interactions {572} and even in highly energetic phenomena on Earth, when the supersystem changes are also accounted.<sup>265</sup> We argue that novel negative energy phenomenology — such as encountered in the  $COP > 1.0$  experiments by Magnetic Energy Ltd. in

<sup>265</sup> As an example, in looking at sprites and other such sharp electrical discharge phenomena, we may be observing the prompt *decay* of  $COP \gg 1.0$  interactions which were self-initiated in the atmosphere.

various versions of the  $COP > 1.0$  motionless electromagnetic generator (MEG) {573, 574}, by Bedini {575} in his induction of negative resistor actions inside the batteries of battery-powered  $COP > 1.0$  EM systems, and by Sweet and the present author in experiments with the Sweet  $COP \gg 1.0$  vacuum triode amplifier system {576} — is also generated in these  $COP \gg 1.0$  highly energetic astronomical interactions, yielding the same kind of negative energy and negative energy currents.

This Dirac hole negative energy generation of  $COP \gg 1.0$  EM processes is proposed as the mechanism which directly produces the negative energy fields and potentials that generate the mysterious antigravity accelerating the expanding universe {577}. This is a reasonable assumption, even though it is against the received view, because it is based on some laboratory experiments, not just theory. It also is the unexpected effect of the cosmological constant introduced by Einstein {578}, and it is consistent with Zeldovich's demonstration that the energy density associated with Einstein's repulsive cosmological constant is — or is associated with — vacuum energy.<sup>266</sup> The received view *is not* based on direct experiments with  $COP > 1.0$  EM systems, but only on  $COP < 1.0$  EM systems. Until the received view is broader based, it does not adequately represent nature. Hence it does not represent a valid refutation of experimental negative energy systems producing antigravity processes.

In Bedini's experiments and in the MEG experiments, antigravity is essentially absent or so small as to be nearly nondetectable. However, these experiments generally have  $COP$  of 1.5 to 4.0, mostly, and sometimes 10 or 12 (we have experimented up to 20 or more stably, and unstably at nearly 100). Hence the Dirac hole current is relatively small in them, since the magnitude of the Dirac current is a function of  $(COP - 1)$ .

Sweet's  $COP > 1,500,000$  experiments produced a very large flow of negative energy back across the system, substantially curving the local spacetime and reducing the weight of the system on the laboratory bench. Figure 6-7 shows the first Sweet device, which produced six watts output in open-loop operation. Figure 6-8 shows a later Sweet device which

<sup>266</sup> Believed to have been demonstrated in 1967. But check Ya. B. Zeldovich and A. A. Starobinsky, "Particle creation and vacuum polarization in an anisotropic gravitational field," *Zh. Eksp. Teor. Fiz.*, Vol. 61, 1971, p. 2161 (*Sov. Phys. - JETP*, Vol. 34, 1972, p. 1159); Ya. B. Zeldovich, "Vacuum theory — A possible solution to the singularity problem of cosmology," *Uspekhi Fizicheskikh Nauk*, vol. 133, Mar. 1981, p. 479-503. Translation in *Soviet Physics — Uspekhi*, vol. 24, Mar. 1981, p. 216-230.

produced COP = 1,500,000 and was pushed past that COP to produce the antigravity in the laboratory, smoothly reducing its weight by 90%. Figure 6-9 is a plot of the actual readings taken during the antigravity experiment. Sweet performed the experiment in California, reading off the measurements to me over the phone as he made each one.

Another indication of the negative energy effect present in the output section of the Sweet device was tested by suddenly shorting the output leads. This resulted in instant freezing of moisture from the air, so that the leads were instantly frozen and covered with ice. Contrast this to the normal heating of shorted wires, where the energy is positive.

Sweet never revealed his activation process, whereby he initiated very strong self-oscillation — of the nucleus of the barium atom in barium ferrite magnets — with the local vacuum treated as a semiconductor. One part was known to the present author and another part was known to Rosenthal, a professional test engineer. In addition, how Sweet converted his excessive hole current is not completely clear. It appears that he somehow used his coils in quadrature together with special circuitry to interact the excess hole current into his magnets, directly with the self-oscillating barium nuclei and thence with the other nuclei in his magnets. If so, it created the "rough equivalent" of increasing the associated binding energy offset and locked with concomitant additional local spacetime curvature.

If this speculation is correct, he "locked" the nuclei of his magnets to the local curved spacetime, maintaining the overall local binding energy in the nuclei themselves while producing a great excess of "binding energy" (negative energy) in the immediate vacuum. This would explain the antigravity, and would be consistent with the experimental results as well as the increase in antigravity as the output load of the device was deliberately increased.

We must use the supersystem concept, as in the quoted comment at the beginning of the chapter, to enable a better understanding of these novel phenomena. Together with the Dirac negative energy production and high COP system, the hypothesis of "additional negative energy acting on local spacetime immediate to each nucleus" allows the generation of the observed antigravity to be understood. However, we accent that this mechanism is still a hypothesis, and it must be further substantiated by experiment.



### 9.7.1 Lattice Holes

In a material conductor or other component of an electromagnetic circuit, the conventional model envisions currents in the Drude electrons as the electrons moving by "hopping" from molecules or atoms in the material lattices into the Drude gas, with each hop leaving behind a positively charged "vacated electron position" called a *lattice hole*, or just a "hole". Subsequent Drude electrons are attracted to fall into the holes, etc. This net movement of the hopping electrons down the conductor, etc. comprises the conventional electron current through the conductor. We point out that the actual movement of the electrons in their "hopping" is vastly more energetic than the very feeble net "drift" of the overall ensemble of Drude electrons longitudinally down the wire as current. The energy of the total electron activity ongoing in a simple 1-foot length of copper wire would power a city, if it could all be harnessed and utilized.

At the same time the electrons hop with a slow net progress down the wire, the "holes" in the material lattices are also collectively seen by the external observer as if "slowly changing their net positions" longitudinally in the opposite direction. One speaks of a corresponding "hole current" or "lattice hole current" in the opposite direction to the electron current. However, there are subtle differences in the flow of the two currents, because an electron in the Drude gas is far more kinetic than the positive ion left behind by an electron that has "hopped up into the electron gas". Nonetheless, the positive lattice ions do "rock" physically from the induced forces upon them, as the holes are opened and filled. In conventional electrical power systems, this equal and opposite energy reaction in the ions of the lattice materials, induced by the applied fields, is usually ignored. In most classical EM power system theory the holes and their "composite equal and opposite energy and work in the system" are also ignored, except in semiconductors and semiconductor circuits.

### 9.7.2 Newton's Third Law Is Accounted in the Supersystem

Because half the EM energy and work in the circuit is usually ignored (e.g., in the Maxwell-Heaviside-Lorentz standard equations), electrodynamics is said to be free from Newton's third law reaction. This may be a non sequitur, and it follows from the assumption that — for an EM wave, field, or potential in space — no interaction exists with the active vacuum or with the curvature of spacetime. In fact, those reactions do exist in the supersystem. The field, wave, and potential do indeed interact with both the quantum mechanical vacuum and the general relativistic spacetime.

Indeed, the field, wave, and potential may be said to *identically be* changes induced in general relativistic spacetime. The absence of the "transmitting" physical system leaves us with the remaining two components of the supersystem, each of which extends to infinity. Again, Figure 9-1 shows the actual interactions (the supersystem) and Figure 9-2 shows the erroneous and arbitrary "kill of the supersystem" by standard classical electrodynamics.

When higher group symmetry electrodynamics such as  $O(3)$  is applied, then the interactions between the three parts of the supersystem emerge and must be accounted. This is particularly true of  $COP > 1.0$  EM systems. However, as Finster points out {564}, the Dirac sea effects exist *wherever* there are EM fields, potentials, and waves. We add that curved spacetime effects also exist *wherever* there are EM fields, potentials, and waves. And wherever Dirac sea effects exist, or wherever curved spacetime exists, then there the local vacuum and local spacetime interact with each other.

However, as we shall point out, usually most of the Dirac sea hole effects can be neglected in  $COP < 1.0$  systems and in most lower gain  $COP > 1.0$  systems because of the time-energy aspects. For  $COP \gg 1.0$  EM systems, the time-energy aspects are partially reversed, and instead of carrying the hole effects away from the system, the time-force from system output to input forces the Dirac sea holes to flow back in the local vacuum across the system from its output to its input. This flow constitutes an additional "load" appearing in the input section and requiring additional electron current from the external power supply to fill the holes. If the power supply does not furnish sufficient electrons to fill the hole current at the input section of the system, then the unfilled hole current passes back into the feeder line toward the external power supply, and even into the distant power supply itself. In its progress, it eats incoming current all along the way, requiring that more current be furnished by the distant generators.

## 9.8 Remarks on the Observed Acceleration of the Expanding Universe

As a candidate for *dark negative energy*, the present author has proposed vacuum negative energy and currents in curved spacetime regions partially containing excess *empty* Dirac sea holes as well as normal *filled* Dirac sea holes. The process by which these excess Dirac holes are produced has been advanced, and is supported by at least one dramatic experiment. One result of such "negative energy areas" of negative spacetime curvature would be "jumps" increasing the velocity of light and high-energy particles

traversing these altered regions of spacetime. In fact, there is some evidence for just such jumps, according to a hypothesis by Richard Lieu of the University of Alabama in Huntsville {580a, 580b}. Otherwise, high-energy particles produced in distant processes in the cosmos would not be detected on earth, but would be annihilated in highly energetic collisions.

The departure of large-scale spacetime from homogeneity would also result in some loss of correlation in the presently fitted red shift versus distance relationship. Again, there is tentative indication that such may prove to be the case. The most distant galaxy recently detected has a red shift of 6.56, which — assuming homogeneity of space — implies look-back of 14 billion years or so.<sup>267</sup> (conventional view) Best estimates of the age of the universe based on the Big Bang assumption is some 14.7 billion years. It would seem that 0.7 billion years is a very short time for that observed galaxy to have formed. If even more distant galaxies are observed with larger telescopes to become available, then by the redshift correlation to homogeneous space one would be observing galaxies "before the beginning of the universe" — an obvious non sequitur. It appears that the redshift correlation to velocity and distance, as well as the homogeneity of space and in fact the Big Bang itself— are already in some difficulties and may be in serious trouble in the near future.

The empty Dirac sea 4-holes in the vacuum are special "Dirac negative action quanta" and the holes and their dynamics form negative action potentials, currents, and fields. This type of vacuum condition containing some empty Dirac sea holes is referred to as a *Dirac-polarized vacuum*.

However, we do not envision the Dirac-polarized vacuum as just simple *static* polarization, but as possessing rich dynamics such as negative energy currents, potentials, fields, waves, etc. including in the time-energy medium in the time domain. We also include the interaction of the dynamic Dirac-polarized vacuum with spacetime.

<sup>267</sup>I am indebted to Prof. Stanley Jeffers for this information, in his E-mail discussions with the Alpha Foundation's Institute for Advanced Study fellows. Dr. David Roscoe contributed the fact that the Big Bang theory has so many parameters that nearly anything can be "fitted in". But he also pointed out that W. M. Napier, *Astronomy & Astrophysics*, Vol. 310, 1996, p. 353 gives a very thorough analysis of the quantized cz phenomenon, which does present a difficult obstacle to Big Bang theory. Napier is **the** originator of the cometary catastrophe theory of biological extinction. One way or another, the theory of the Big Bang is in trouble, even though many theorists are still complacent about it.

Due to ongoing COP»1.0 processes involved in highly energetic astronomical phenomena, Dirac sea 4-hole regions and dynamics are believed to occur and exist in the vacuum across the observable universe. These occur especially in appreciably curved spacetime regions with large tempic potential gradients and thus large *time-forces* across the region.<sup>268</sup> The 4-holes and 4-hole currents in the vacuum are generated in great quantity in large cosmic explosions. Also, the energetic fluctuations of the local vacuum energy can separate a Dirac hole from its occupying electron by lifting the electron (pair production), and so can a curved spacetime. In a properly curved spacetime, fluctuation can lift an electron from a hole, and enter a stationary state by accommodating reaction of the local spacetime curvature. In that case, hole and electron go their separate ways. The hole and that or another electron may later recombine, or in sufficient local spacetime curvature, they can remain apart. We point out that every positive energy electron is accompanied by an appropriate local curvature of spacetime that prevents the accoutrement of a free Dirac sea hole,<sup>269</sup> and thus prevents the electron from disappearing.

The more energetic the local region, the more severe and violent are local spacetime curvatures in that region, and — in our view — the more frequent the occurrence of COP»1.0 interactions producing significant Dirac 4-hole currents, negative energy EM fields and potentials, etc. Indeed, the measurements that yielded the accelerating expansion of the universe were measurements of the relative velocities existing with stellar explosions known as type Ia supernovae. In our view, in explosions of such violent nature — particularly including in optically active gases such as where gamma ray bursters form — an appreciable fraction of the hole currents are transduced into positive energy electron currents. This produces — at least for a finite time — a net positive feedback, self-powering COP»1.0 phenomenon, resulting in very rapid asymptotic

<sup>268</sup> We also conjecture that these regions may account for a tentatively observed slight change in the fine structure constant, but leave that to the advanced theorists to validate or falsify.

<sup>269</sup> This needs a bit of modification. Rigorously, the so-called "isolated" observable electron is clustered around by *virtual* positrons (Dirac sea 4-holes) in the vacuum. So a positron influence is present, though from virtual positrons instead of observable positrons. The magnitude of both the positive charge and the internal or "bare" negative charge is infinite. The difference, however, is finite and is the "observed" magnitude of the observable central charge. There is thus a net observed shielding of the bare charge of the electron, and this is taken into account to yield the observed charge of the electron.

output energy increase. This is what we have hypothesized as producing the gamma ray burster itself. *Quenching* of this asymptotic rise in COP occurs only after the physical geometry of the "closed-looping" gas particles is broken a short time later. The maximum output energy is determined by a function of the *rate* at which the geometry is broken and the corresponding *rate* at which damping of the asymptotic rise and quenching occurs. The afterglow remaining in the gas is due to the extra positive energy produced in it by the transduction of negative energy into positive energy during the asymptotic rise of the self-powering burster, with excess positive energy being absorbed in the gas while the burster magnitude is rising. After damping and quenching, the gas has been heated (that is how the geometry was disturbed in the first place, to produce damping and then quenching). Re-ignition can occur whenever a new close-looping  $COP \gg 1.0$  situation spontaneously occurs. As in the gamma burster, this can often happen as the disrupted geometry of the gases stabilizes.

All 3-space EM energy comes from the time domain, as previously developed. In the more violent positive energy  $COP \gg 1.0$  regions, there is an increased conversion of time-polarized EM energy into 3-spatial energy and back. On the average there is a higher "time-energy conversion" or "tempic" potential. In those regions, a tempic conversion potential is higher at the higher center magnitude of the spatial energy density. Hence there are strong tempic forces from "inside to outside", providing a "tempic broom" effect to sweep outward the excess Dirac sea holes separated from their electrons in the curved spacetime. The result is the presence of increasingly unoccupied Dirac sea 4-holes toward the outside of violent regions of spacetime,<sup>270</sup> until the effect is overcome by the decreasing spacetime curvature. The 4-hole current radiating out from an asymptotically increasing (exploding) burster provides an asymptotically increasing (exploding) negative energy and negative mass reaction with spacetime. That reaction explosively creates curved spacetime for negative gravity (repulsive gravity), acting upon the local system and upon distant masses as well. The result appears to be the cause of the acceleration of the expanding universe.

It follows that re-ignition of the gamma burster can occur if, as the quenching continues, the geometry stabilizes and reaches another "close-

<sup>270</sup> I.e., the violent astronomical phenomena — while generating and increasing are more violent at the center, and less violent at the outside.

looping" positive feedback condition. In fact, just such re-ignition of the gamma burster is very often observed.

Therefore, we hypothesize that the more distant violent astronomical regions have greater amounts of repulsive gravity being produced by their local Dirac-polarized vacua particularly during their explosive asymptotic energy density rise. This produces violent streams or bursts of negative energy outflow, which is equivalent to negative mass outflow and which provides outgoing negative curvature of spacetime (antigravity). At sufficient distance from us, the increasingly earlier, more violent events and resulting greater curved spacetime regions have created sufficient cumulated Dirac-polarized vacua to override the normal attractive gravity between galaxies, etc. and produce net repulsive gravity. This results in observed distant acceleration of the expanding universe {581a-581f}.

## 9.9 A Solution to the Hole Current Problem and Close-Looping

Bedini and the present researcher have filed a patent application {582} on the above special capacitive process to *convert* or *transduce* the detrimental Dirac sea hole current reaching the system's input section into electron current, and put it to use in powering the system. This transduction process receives the hole current as a special potential, then regauges the "negative energy" potential into a "positive energy" potential. This regauging is accomplished by charging the capacitor with Dirac hole current and then discharging electron current from it. The transformed positive energy potential is then applied to the Drude electrons, producing an ordinary electron current in the input that can be used to power the system itself. If sufficient excess positive electron current is provided, then the system can "feed itself in self-powering mode and also feed power back into the main power supply line.

When conversion of the arriving hole current in the input section produces an output "positive energy" electron current equal to the system's normal power needs (Kron's condition), the external power supply can be disconnected and the system will remain powered by the steadily converted negative hole current arriving in the input section.

Our patent-pending process allows this otherwise devastating special form of "negative energy feedback" to be converted into "positive energy feedback", allowing the system to be close-looped successfully for self-powering of the system and its load. Regulators of the transduction process may be added to cover the situation when the load is erratic and changing.

At Magnetic Energy Ltd., we have also filed a patent application for an outrigger method of close-looping a COP>1.0 system, which greatly eases the problem. This method is covered in Paragraph 9-14 below.

## 9.10 Negative Energy: Localized and Nonlocalized

It sometimes appears there are as many views on negative energy as there are scientists who mention it. Simply put, the Dirac theory of the electron requires negative energy states. The negative energy electron state was envisioned by Dirac as a sort of "hole" in the ambient vacuum, where the hole could contain a positive energy electron. The combination of equal positive energy of the electron and negative energy of the hole itself, would give a "normal" vacuum zero state of the "filled hole". In other words, the normal or ambient vacuum consists of holes filled with electrons. Considered in that fashion, such a vacuum is referred to as the **Dirac Sea** or the **ambient Dirac Sea**, or the **ambient Dirac vacuum**.

If positive energy is added to a filled Dirac hole, the electron can be lifted out, leaving the hole. Note that adding positive EM energy, e.g., is actually the addition of spacetime curvature and dynamics to the Dirac sea vacuum. In short, it is a supersystem interaction, not a system interaction.

In that case, the curvature of the local spacetime interacts upon the electron mass, producing a force that lifts it from the hole. The result is the appearance of a positive energy, positive mass electron and a Dirac sea hole (a 4-positron) in a curved spacetime. That is known as *pair production*, and it is a supersystem interaction. When a positron and an electron meet, the electron falls into the hole, changing the Dirac sea which also changes the local ST curvature. That change in local ST curvature is a change in the energy density of space, and is normally radiated away as a photon or photons as the local curvature decays back to a flat spacetime. The emitted radiation may further decay into particles, etc. by several reactions well known in particle physics. That "conventional" set of supersystem interactions is known as *pair annihilation*.

If we deliberately change the ST curvature appropriately, however, the pair annihilation radiation need not be emitted since the excited local spacetime curvature does not decay back to a flat spacetime to emit it.

Dirac's original paper tried to identify a negative energy state vacuum hole as the proton, but later that was falsified and it was taken as the positron. There is a very strong aversion in physics to considering negative mass; hence, the mass of the positron was proclaimed positive (for many reasons

not really connected with our thesis). Nevertheless, some physicists (in the minority) still speculate or theorize that negative mass "can exist." Not only "can" it exist, but also it *does* exist widely and one can demonstrate it in actual electrical circuits. It certainly exists in the binding energy of the nucleons in the nucleus of an atom. Again, a single white crow is sufficient.

We take a very straightforward view: we consider a positron — an electron observed with positive mass and "observed" to be traveling backward in observer time — to be a different (transformed) entity than a Dirac 4-hole traveling forward in observer time.<sup>271</sup> The observation operator accomplishes both velocity reversal and time reversal, and — since time is not an observable, the time reversal is "seen" as a reversal in spatial direction. *Prior to observation, neither reversal has been imposed.* The major distinction, we hypothesize, is that the observed positron has positive mass in 3-space, which is concentrated positive energy, and therefore produces positive energy electrical fields and positive gravitational field. Mass is an observable, hence, it is the iterative frozen 3-space snapshots of an ongoing 4-space process. Observation (and any observable) is the effect of applying the operator  $\partial/\partial t$  upon spacetime LLLT in which a 4-space process is occurring. As we stated earlier in this book, our view is that no observable *continuously persists* (in time), but continually and iteratively *recurs* by the continual ripping of time from the ongoing 4-space reaction, to see the 3-space intersection at a frozen moment. We also advanced the *mechanism* that generates the flow of a mass through time, consisting of a mechanism for  $\partial/\partial t$  (LLLt) - photon emission, converting  $mt$  to  $m$  — and the mechanism for  $\int_t$  (LLL)dt — photon absorption, converting  $m$  to  $mt$ .

<sup>271</sup> This point is stressed. The *unobserved* positron is not identically a positive mass electron traveling backwards in time, but a negative mass, negative energy electron traveling forward in time. When Dirac theory of the electron was written, broken symmetry and the CPT theorem had not been discovered. Further, there was no distinction made in the difference between the observed entity (the *effect* of the observation interaction) and the non-observed entity (the *cause* of the observation interaction).

<sup>272</sup> We stress that we are once again confronting the ubiquitous substitution of the effect for the cause in classical electrodynamics. The observed positron and the unobserved positron are two quite different entities — just as the "cause" of an observation is quite different from the "effect" of the observation.



We may also consider mass to be condensed 3-spatial energy (say, EM energy) compacted by  $c^2$ . Modern physicists tend to consider the mass-energy itself as the source of the gravitational "attraction of mass" rather than the mass itself {583}. Let us accept that assumption, but differentiate between the observed 3-positron with positive mass and opposite direction in positive observer time, and the unobserved Dirac sea 4-hole with negative mass and without change of direction in the observer's positive time. The 3-positron is an *observed effect*, while the unobserved Dirac sea 4-hole is an *as-yet-unobserved cause*.

We also surmised that all EM energy in 3-space comes from time, by our solution {584a} to the long-vexing source charge problem {68}. In our view, we may then consider that the positive energy compressed as 3-space mass has been extracted from the time domain of surrounding spacetime, via entry of that time-energy into the surrounding 3-space at each 3-space point, producing a surrounding spacetime curvature which is known as the *gravitational field*. This gravitational field represents "withdrawn" 3-space energy from surrounding space, and withdrawn time-energy from the time associated with each surrounding 3-space point.

Hence the gravitational field may be said to consist of "negative energy" since it represents *lowered* energy of spacetime due to the curvature. This viewpoint yields results consistent with the received view that the energy of the gravitational field is negative. In our view, it is negative precisely because it represents "withdrawn energy" from the normal energy density of that otherwise flat space. The withdrawn nonlocal energy has been localized (as what we call "mass"). Simultaneously that withdrawn 3-spatial energy also represents "withdrawn energy" from the time-domain, since all the withdrawn spatial energy came from the time domain in the first place. The result is the curvature change in spacetime, that is taken as the gravitational field.

The 3-space energy comprising the mass is positive because it is *added to* the normal energy of an otherwise flat spacetime, at that concentrated locality.

The "energy in the gravitational field" is negative because it represents lowered energy density (i.e., lowered "pressure" in a fluid analogy) of that surrounding nonlocal spacetime compared to when that spacetime was flat

Thus when we add positive energy (a positive energy state) to 3-space, we create normal "positive" gravity because "mass" is a process of withdrawing some positive energy from the energy density of surrounding 3-space.

Here is the shocker: When we add localized negative energy (a localized negative energy state or "4-hole" — or a localized negative mass!) to a local 3-space region, we create "negative" gravity (antigravity) in surrounding space because the withdrawn energy from the local 3-space "hole" must have been added to the energy density of the surrounding spacetime, once we apply conservation of energy. Or in other words, the surrounding spacetime changed (curved) in interaction to the production of the hole.

If we wish, for simplicity we can just consider localized positive energy to generate positive gravitational charge in the surrounding nonlocal spacetime. We can consider localized negative energy to generate negative gravitational charge in the surrounding nonlocal spacetime.

This is where our concepts differ from the rather arbitrary way that a Dirac sea hole is interpreted in the received view. In spacetime, we try to account for the entire energy process and we apply a conservation law by including the supersystem interaction in every case. We insist that positive energy concentrated in positive local mass must have been extracted from surrounding spacetime.<sup>273</sup> That "negative energy" in the surrounding spacetime is what is known as the *gravitational field of the source mass* (where the energy was withdrawn to). Similarly, we insist that positive energy extracted from a localized region of the ambient vacuum to leave a "Dirac sea hole" must have been spread out into the surrounding spacetime, where it would properly be known as the *antigravitational field of the source Dirac hole*.

As an analogy in very simple lay terms, the holes associated with a local mass system or region involved in COP>1.0 operations create higher "pressure" outside the system or region with respect to other objects. Higher pressure between any two objects pushes the objects apart. The masses associated with a mass system create lower "pressure" outside the system or object with respect to other objects. Lower pressure between any two objects results in the objects being pushed together by the higher pressures beyond them.

<sup>273</sup> Alternatively, if we add local spacetime curvature, the surrounding nonlocal spacetime interacts as mediated by the supersystem changes in all three components. What we are saying is that there is no such thing as just a system, vacuum, or spacetime change. Any change to one is accompanied by a change to the other two, *a priori*.

We submit that this new view provides an exact (and testable) antigravity mechanism. It appears to have been validated by the Sweet antigravity experiment {576}, which was designed in advance by the present author with increasing the local negative energy reaction in mind.

## 9.11 Tests Reinforcing the Antigravity Mechanism

### 9.11.1 Dirac Sea Hole Current Effects in a $COP \gg 1.0$ EM System.

For  $COP \gg 1.0$  electromagnetic systems, we recall that the temporal energy will flow negatively across the system from output section to input section. Hence the Dirac sea hole current in the local vacuum flows back across the system, from its output to its input section. Regarding the output section: *Specifically, all  $COP > 1.0$  systems produce both positive and negative energy outputs. The greater the COP of the system, the greater the fraction of negative energy produced with respect to the fraction of positive energy produced.*

The positive energy will flow on out of the system output section (as into the external load) as in a normal circuit, but the negative energy output will flow from the output section through the local vacuum back across the system to its input section.

At the input section, the arriving Dirac holes appear to the input electrical current as a special kind of "load" added to the system input section. Hence, as previously stated, the external source must input electrons (as electron current) to "fill the holes" prior to having any input electrons available to power the circuit in normal fashion.

That is nature's unexpected *overunity decay mechanism* for  $COP > 1.0$  EM systems. The  $COP > 1.0$  system is in a condition of disequilibrium *a priori*, since the system exhibits negentropy and only systems in energy flow disequilibrium with their active environment can do that. Any  $COP \gg 1.0$  EM system is therefore in a highly excited state, and all excited states in nature have decay mechanisms. A highly excited state usually has a prompt decay mechanism, and the  $COP \gg 1.0$  system is no exception.

This emergence of the Dirac hole current from the system output section back to the system input section, is nature's decay mechanism to trigger  $COP \gg 1.0$  EM systems back into  $COP \leq 1.0$ . With this current, a "negative energy load" is added to the input section, causing the system to draw additional electrical power from the external power supply to

"power" the killing of the Dirac holes<sup>274</sup> as well as to "power" the normal circuit (the system itself).

If the external power source connected to the COP»1.0 system is not furnishing sufficient electron current to kill the hole current in the input and power the system as well, the excess hole current will pass back through the conductors and on into the external power source, "eating current" and power as it goes. The product of the hole current and the voltage gives a negative power imposition, wherever the hole current interacts with the power system and its external power supply, even back into the distant huge power generator in the distant power plant. For a battery-powered circuit, e.g., excess hole current will pass into the battery and discharge it (change its chemistry in discharge mode) more quickly.

Indeed, a lead-acid battery (and some other kinds as well) can be supercharged with Dirac holes. What this actually means is that the local vacuum — in which the battery and its components and chemistry are embedded and in a continual exchange with — is altered to increase the number of empty Dirac sea holes devoid of electrons. At the same time, the local spacetime is also negatively curved. The end effect is that the battery is charged with negative energy, rather than positive energy. We propose that a battery or capacitor possessing an extreme negative energy charge should be lighter in weight than the same capacitor when uncharged.

As previously stated, some years ago, Jim Watson developed a very large multi-kilowatt COP>1.0 battery-powered generator, publicly demonstrating it at a technical conference (see again Figure 5-12). Engineering measurements at the conference verified that the batteries were constantly charging while the load was constantly powered at 8 kilowatts.

The longer Watson's system would run, the more charged his batteries became with *negative energy*. After one of his batteries had been used for a couple of weeks in extensive experiments, one could obtain a most novel effect when it was placed on a normal "positive energy" battery charger. The battery's excess "Dirac hole charge" or "negative energy charge" accumulated in its local vacuum would "eat positive power and electrons" from the battery charger for an extended period, sometimes as long as a week, with no symptoms of "charging" the battery at all (no increase in

<sup>274</sup> By converting separated incoming electrons and incoming holes to resulting filled Dirac sea electron holes, in the input section itself.

battery voltage at all). During this period, the battery charger was indeed recharging the *battery supersystem*. It was filling the excess Dirac sea hole charge in the vacuum with the steadily supplied electrons. In the process, it was gradually relaxing the previously formed negative spacetime curvature.<sup>275</sup> When all the Dirac holes were filled, the relaxed spacetime then was relatively flat (normal) as was the local vacuum, and suddenly the battery would charge-up normally again with positive energy, with its voltage increasing in quite normal fashion.<sup>276</sup>

With tongue in cheek, we point out to the COP>1.0 researcher that these effects are not described in the available storage battery manuals, no matter how technically they are written. To the electrical engineer, we point out that they are not in his textbook.

Whenever Dirac sea holes have accumulated in the input area of the COP>1.0 system and are being filled by the external power supply, normal ammeters and voltmeters will only "see" that the external power system is furnishing more current. That is true, because the holes are an additional load being powered. The holes "eat incoming electron current and power", and require the external power supply to "power the killing of the holes" as well as "power the system".

The unwary overunity experimenter can successfully have the first phase of an overunity system working and not realize it, because his initial COP is too high and he does not know about the associated hole current decay

<sup>275</sup> This proves that a system's supersystem can indeed be negative-energy-charged, so that the local spacetime around that system is negatively curved, even though the system itself seems normal and functions normally. If the negative energy charge is sufficient, conceivably the antigravity produced will be sufficiently great that the system itself "floats" or even levitates. We hypothesize that an intense negative energy beam can indeed be technically created which will accomplish this "negative-energy-charging of the supersystem" effect when continuously absorbed by a targeted system's local spacetime supersystem component, as the system is continuously irradiated by the beam. In that manner, levitation beams, tractor beams (both attracting and repelling) are at least hypothetically possible. If this proves to be a valid hypothesis, we foresee the day when such beams will revolutionize transportation and handling of otherwise heavy loads and very heavy systems. Even the heaviest vehicle could then negatively charge its own supersystem's local curved spacetime, thereby floating in the earth's gravity, in the atmosphere, in space, and under the ocean.

<sup>276</sup> We deliberately omit discussion of the extraordinary all-purpose weapons implications of negative energy electromagnetic pulse (EMP) directed energy weapons, already developed and deployed by several major nations.

of overunity systems back to underunity systems. His system may actually be at  $COP > 1.0$ , but the negative energy component being produced in his output section is back-flowing and continuously degrading his input section by adding a "new load" right in the input section.

So his overall power draw from the external power source can be such that his positive power output in the load is less than his total power draw at the input of his system. Unless he is aware of the process and how to handle it, he may never realize that his system is actually at  $COP > 1.0$  condition, when the negative energy component is credited as an output "plus".<sup>277</sup> *COP > 1.0 research starts by evaluating the absolute value of the output energy, then working from there!* The experimenter must be ever aware that he can and will have Dirac sea 4-holes and currents in any unitary  $COP > 1.0$  electrical power system, and particularly in those with very high COP. He must understand what the 4-hole currents and the negative energy actually do and how they function in the overunity system unless corrected.

Any  $COP \gg 1.0$  EM system demonstrates the Dirac sea 4-hole current phenomenon as nature's special decay mechanism to reduce overall performance of the  $COP \gg 1.0$  power system and its external power supply to  $COP < 1.0$  — unless one *corrects* the problem and prevents the decay process (developed later in this chapter).

One symptom of the negative 4-hole currents is their cooling capability rather than heating. Another is that the excess current (and power) drawn from the external power supply also does not heat the input section of the system. Another is that semiconductors operating within the Dirac 4-hole current flow are likely to fail immediately and permanently.

We strongly suggest that, for high COP systems experimentation, the experimenter use a system of synchronized clocks where the lab clock is synchronized with a remote clock prior to the experiments, then the two clock times are examined after significant experimentation at  $COP \gg 1.0$ . If deviation beyond normal error in synchronizing occurs, then the involvement of spacetime curvature effects is indicated. Two decades ago, anomalous experiments by Golden — with whom I was working at the time — charged the area with negative energy, producing a significantly

<sup>277</sup> In other words, in the presence of both positive and negative energy output, true COP is not "positive energy out" divided by "positive energy input by the operator", but is more appropriately "total absolute value of the energy output" divided by the "positive energy input by the operator".

curved local spacetime which disrupted local clocks and watches for four days as the charge gradually decayed away. Another indicator is that Geiger counters and other nuclear radiation detectors often "read" when bathed in vacuum 4-hole current, because of the ionization changes induced in them and also because of their individual previous "time-charge" histories. After all, ionization instruments "read" anything which causes ionization of their internal gases. Dirac sea hole current, if interacting with the gas, is in fact a very special new form of "ionizing" radiation.

### **9.11.2 Antigravity Hole Current Effects in a COP»1.0 EM System.**

Any COP>1.0 EM system can exhibit minor, usually barely detectable antigravity effects due to the presence of the negative local energy 4-holes in the hole current if the hole current is not transduced or corrected. It can also produce minor antigravity "thrust" due to the flow of the local energy holes. Usually these effects are not even noticeable in an overunity system unless it has very high gain (very high COP, say in the range of  $10^5$  to  $10^6$  or more.).

However, if the EM system's COP » 1.0, and reaches  $10^5$  to  $10^6$  or more, the antigravity and thrust effects may become significant and easily detectable. At  $10^9$  they become highly significant and are very detectable: The unit will lose appreciable weight on the laboratory bench, and may even levitate easily.

An example is provided by the Sweet vacuum triode amplifier discussed above, with the results that were given in Figure 6-9. Such effects are also what generate the anomalous levitation phenomena of free-spirited John Hutchison.<sup>278</sup>

### **9.11.3 Negative Energy Effect When Leads Shorted**

When the leads of a COP>1.0 EM system are shorted, a noticeable cooling effect can sometimes be detected. If COP»1.0, shorting the leads will result in instant icing from the water vapor in the surrounding air.

If one accidentally shorts oneself across the leads of a COP»1.0 system, the effect is to freeze the nerves along the pathway of conduction. Experimenters are cautioned to use every safety precaution. Their experimentation is at their own assumed risk.

<sup>278</sup> John Hutchison, "The Hutchison Effect apparatus." *Proc. Intl. Symp. New Energy*, Denver, Colorado, May 12-15, 1994, p. 191-198.

Anecdotally, some older researchers reported that their constant handling of overunity circuits resulting in charging their bodies, apparently with negative energy. The body after all may be considered as a special kind of complicated capacitor or set of capacitors, so this is reasonable, based on Bedini's and Watson's demonstrated negative energy charging of a battery. Some of the older overunity researchers reported that, after charged in that manner, they could produce a 3-inch spark from their fingers, or a "slight shock" into the body of a person they touched.

There is even a special form of acupuncture in the East in which the practitioner uses special exercises to charge the body with negative energy in this fashion. The "electro acupuncture" is then administered by the operator twirling the inserted acupuncture needles between his fingers, and deliberately administering a jolt of negative energy from his body into selected points in the body. I have personally tested a person who could deliver strong "electric shocks" into one's hand or body, and who could consistently produce a 1-inch spark discharge between the hands at will. That person could also deliver a very astonishing "jolt" to one's body, particularly in the vicinity of the liver.

There appear to be similar rare negative energy phenomena in semiconductors {585a-585c}. Anecdotally, it appears that the body does have structures or methods of storing and using Dirac sea holes (negative energy) and mechanisms for accessing the negative energy charged in its supersystem. This is suggested as a fruitful line of future research for interested biophysicists. Again, we call attention to the fact that, whenever EM fields, potentials, and waves are present, Dirac sea effects are also present and involved. Little or no biophysical experimentation has been done utilizing higher symmetry electrodynamics and analysis of the supersystem effects. Contrary to the received view, the understanding of EM effects on biological systems is not mature at all, but is still in its infancy.

## 9.12 Susceptible Unitary System without Conversion of Dirac Sea Hole Current

A *unitary system* is simply a self-contained single power system with an overall closed current loop between the source dipole and system loads and losses. A unitary system is contrasted to an array system of synchronized separate power subsystems without a common closed current loop, with the array subsystems connected to the source dipole by energy



transmission-reception only. Hence the array system utilizes the Kron open path concept.

Beginning at about  $COP = 1.2$  to  $1.5$ , a few highly susceptible unitary  $COP > 1.0$  electrical power systems will experience significant Dirac hole current from output to input. This will produce a "negative energy load" in its input section and feed line from the external power system, resulting in decay back to an overall "system plus negative energy load" of  $COP < 1.0$ . At the  $COP = 2.0$  level, in the susceptible system the effect will forcibly decay the COP back down to overall  $COP < 1.0$ . It does this by forcing excess power to be furnished by the external power system to "power" (fill) the Dirac hole current arriving in the input section of the power system. In short, it converts the system to a composite system containing an additional Dirac negative energy load in its input section.

Or in other words, it forces the operator to "pay" for both the *positive* energy output and losses of his system and the *negative* energy output and losses of his system.

In addition to usual powering of its load and losses, such a system is also "powering" the return of its own locally altered vacuum back to a more normal ambient vacuum, instead of stabilizing its supersystem in a stationary disequilibrium state. It is a supersystem interaction and effect. A  $COP > 1.0$  system that significantly exhibits this phenomenon is said to be a "susceptible" system.

One of the first tasks of the  $COP > 1.0$  experimenter is to ascertain whether he is working on such a highly susceptible  $COP > 1.0$  system. Ironically, he does this by observing his  $COP > 1.0$  system kick itself back into a  $COP < 1.0$  system. If he carefully observes the initial  $COP > 1.0$  condition followed by decay into  $COP < 1.0$  condition, he must then realize that not all is lost! In short, he must realize he has developed a susceptible system. If he obtains  $COP > 1.0$  only to watch it subsequently decay back to  $COP < 1.0$ , he has just discovered he is working on a susceptible  $COP > 1.0$  system, *and that is experimental progress*. He isn't there yet, but he is en route. In that case, he must concentrate on transducing the excess hole current into usable electron current, to "stabilize" and "lock" his system in its  $COP > 1.0$  operating condition.

### 9.13 Unitary System with Conversion of Dirac Sea Hole Current

Using the Bedini conversion process, a unitary system can be close-looped to maintain  $COP > 1.0$  and stable overunity operation. The 4-hole current reaching the input section is intercepted by the Bedini mechanism, and transformed to ordinary electron current furnished to the input section. Thus the transduced negative energy feedback becomes a positive energy feedback, by conversion. This converted positive energy in the input section will reduce the demand for incoming electron current from the external power supply, increasing the  $COP > 1.0$  even more.

A feedback and governing system is adjusted until the system's converted positive energy feedback current reaches the Kron condition. At that point, the transformed electron current is sufficient to power the system with the external power supply disconnected. The governing and control system thus disconnects the external power supply, and the system is smoothly transitioned to self-powering operation, powering both itself and its load.

We stress that all the energy to power the system and its load is now being furnished from the active local vacuum interaction and from the local curved spacetime. No laws of nature, physics, higher symmetry electrodynamics, or thermodynamics are violated. Conservation of energy rigorously applies, but to the supersystem. The system is an open, *stabilized* disequilibrium system — of the kind referred to by Kondepudi and Prigogine as nonequilibrium stationary states — as a freely receiving all its energy from its active external environment. No standard U(1) electrodynamic analysis will show this condition or this mechanism, and neither will electrical engineering. Higher group symmetry electrodynamics such as SU(2) or O(3) will show it easily. For a modern treatise on O(3), we refer the reader to the recent *tour deforce* by Evans {586}.

### 9.14 Non-unitary Outrigger Array System

See Figure 9-14, which is a diagrammatic representation of a  $COP > 1.0$  array system that is non-unitary. In the non-unitary (outrigger array) system, no part of the outrigger array works at  $\xi > 1.0$ . All external parts operate at  $\xi < 1.0$ , but independently and with  $COP > 1.0$ . Each of the external outrigger systems is an open system freely receiving excess energy from its active environment, because it is an "energy-receiving" system and the energy is freely transmitted from the central system. The central part of the array is the unit whose purpose is to stimulate or evoke

an excess energy flow from the vacuum, so that the outrigger receiver/power units can individually intercept and utilize radiating energy flow surrounding the central unit.<sup>279</sup> The usable (output) energy intercepted and captured (collected) from a given free flow of energy depends totally on the intercepting reaction cross section — usually the total array amount of intercepting charge, together with the degree of resonance (sweeping a larger geometrical cross section) of the intercepting charge.

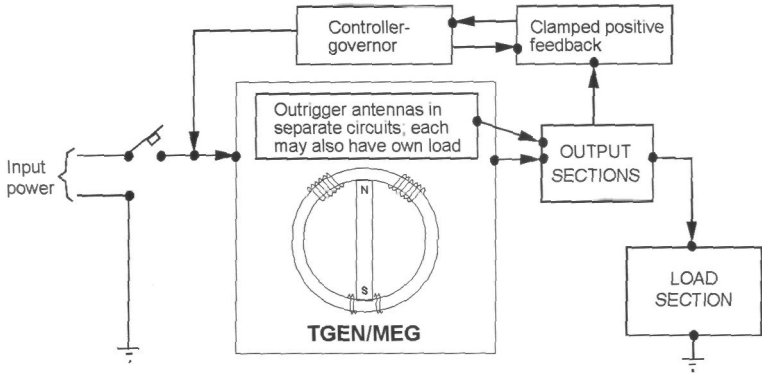

Figure 9-14 The nonunitary (outrigger array) system and its functioning.

Each outrigger unit (subsystem) has its own complete closed current loop *separate* system and load, plus its "antenna" or "interception section" or receiving component for intercepting and collecting the free flow of energy coming from the central source unit (the energy transmitter). Thus, the loads in the outrigger units are not closed-current-connected with the central source unit at all. Each outrigger unit has its own independent electrical ground and its own closed loop system with its load.

<sup>279</sup> We emphasize that, when the usually unaccounted Heaviside nondiverged energy flow component surrounding the conductors of the external circuit is accounted, every EM power system is already a  $COP \gg 1.0$  EM energy transduction system. Consequently, in the received view the array system can be operated at  $COP > 1.0$ , or even in self-powering mode, even though the central system is "said" to be at  $COP < 1.0$ . It is at  $COP < 1.0$  only because of the self-applied Lorentz symmetrical regauging and ignoring the excess unused energy flow available to and surrounding the circuit, but not conventionally used. If we account the COP for what we have to furnish to the central unit, then the COP of each array unit is  $COP = \infty$ . The point is that we ourselves do not have to pay any *extra* input energy for the output energy of each array circuit.

This schema in fact separates the two functions of Poynting energy flow theory: (i) the extraction and radiation of the EM energy flow from the seething vacuum, and (ii) the interception, collection, and dissipation of some of that available energy flow, to power the loads and losses of the intercepting system.

In this fashion, multicollection from a single energy flow (generated from a central source "transmitter") occurs by direct, independent interception and collection in each of the COP<1.0 outrigger units. However, the input power to each outrigger units is *free* with respect to that outrigger circuit itself. We of course must pay to generate the flow of energy from the central unit, but that can be done in normal COP<1.0 manner (such as COP = 0.95) while powering its load.<sup>280</sup> Let the output power of each numbered unit (including the central source unit) be given by  $P_i$ ,  $n$  be the number of power units, and  $P_T$  be the total power output. Then the total output  $P_T$  of the array system is given by

$$P_T = \sum_i P_i = P_1 + P_2 + \dots + P_n \quad [2]$$

The total input power  $P_I$  is simply the input power  $P_{I(1)}$  to the central source unit. The COP is given by  $\text{COP} = P_T/P_{I(1)}$ .

In the motionless electromagnetic generator (MEG) array, for example, the central unit is the transformer-like unit, deliberately using a special core to contain the magnetic flux of a permanent magnet in contact with the core material, thereby stimulating the Aharonov-Bohm effect and freely filling the surrounding space with the uncurled magnetic vector potential  $A$ . We will explain the non-unitary (outrigger array) system using the MEG as an example.

<sup>280</sup> We again stress that, from any nonzero potential  $\phi$ , or from any EM field in space, any amount of EM energy can be collected if there is sufficient intercepting and collecting charge. For example, the simple equation  $W = \phi q$  applies for the potential, where  $W$  is the energy collected from a potential with point intensity  $\phi$  by collecting charges  $q$ . A similar equation applies with respect to collecting as much force (emf in the various outrigger circuits) as desired. Here a single given E-field  $E$  can be assumed, and  $F = Eq$ . What is happening in the outriggers is that they are intercepting and collecting some of the excess Heaviside energy flow component that is wasted by the central circuit.

The MEG freely induces the Aharonov-Bohm effect,<sup>281</sup> thereby extracting excess energy from the vacuum in the form of that novel field-free A-potential. Being field-free, A represents an energy flow without swirl (without curl). When the MEG input section is perturbed, the surrounding A-flow is perturbed also, giving a pulsed or AC flow of energy that can be intercepted and utilized by each outrigger circuit as an E-field energy interception.

The central unit's  $COP < 1.0$  function is to output almost as much, or as much, energy as is required to power the MEG, while also evoking that excess A-flow and serving as a  $COP \gg 1.0$  energy flow transducer. The function of each outrigger is then to intercept some of the pulsed A-flow (as E-field energy via the equation  $dA/dt = -E$ ), in its antenna or interceptor section. Each outrigger has its own independent and conventional closed loop circuit. It simply is a receiver and user of extra Heaviside EM energy produced from the central MEG unit in the new form of the curl-free A-potential. Perturbing the A-potential produces a large E-field impinging on all the external outrigger subunits. Hence these units freely collect and use some of that available excess energy. The COP of the total array is thus  $COP > 1.0$ . For best results, tuned antenna theory and near field theory should be utilized.

Suppose we operate the MEG central unit at  $COP = 1.0$ . In that case, there is no 4-hole current of significance associated with the central unit or the outriggers, and transduction of hole current into electron current for close-looping is not necessary. Instead, sufficient outriggers are employed so that the total energy  $W_O$  caught and dissipated in their loads by all the outriggers is given by  $W_O \geq W_I$ , where  $W_I$  is the input energy in the main central section. Since  $COP = 1.0$  for the central unit in isolation, the total input  $E_{IN}$  is  $E_{IN} = W_T$  (the additional huge Heaviside nondiverged EM energy input component is there also, but just neglected in conventional engineering). The total output  $W_A$  of the entire array is  $W_A = W_O + W_T$ . The overall  $COP_A$  of the entire array is thus

$$COP_A = W_A/E_{IN} = (W_O + W_T)/W_T = (W_O/W_T + 1.0) > 1.0 \quad [3]$$

<sup>281</sup> The reader should recall that the Aharonov-Bohm effect is not included in classical U(1) electrodynamics. See Terence W. Barrett, "Electromagnetic Phenomena Not Explained by Maxwell's Equations," in A. Lakhtakia (ed.): *Essays on the Formal Aspects of Electromagnetic Theory*, World Scientific Publishing, River Edge, NJ, 1993, p. 6-86.

Hence the array has a  $COP > 1.0$ , even though every single component of the array has  $\xi < 1.0$ . With the outriggers fully functioning, many schemes of operation can be used. E.g., the energy from the outriggers can be used to steadily charge a capacitor bank by "shuttling". We define shuttling as use of two capacitor banks: (1) a capacitor bank which is continually connected and charged by the outriggers as their effective output, and (2) an input capacitor bank for the central unit that is continually connected and recharged from the outrigger capacitor bank. By adroit switching, the charge of the input capacitor bank is maintained by replenishing from the output capacitor bank, and the input capacitor bank powers the entire system, including the output load in the central section.

The non-unitary outrigger array construction is one means of close-looping a non-unitary overunity power system without bothering with the transduction of hole current into electron current. It is the easiest of all  $COP > 1.0$  systems to close-loop for self-powering.

An additional adaptation is for each outrigger also to continuously power a separate load, and only contribute *intermittently* along with the other outriggers to charging the output capacitor bank.

Another adaptation is to operate the central unit in the array in solitary self-powering mode.

These and similar modes of nonunitary array system operation allow close-looping the system for self-powering of itself and its load, without concern **for** 4-hole current transduction. A real advantage of such nonunitary systems without worrisome 4-hole current is that transistors can readily be used for switching etc. in them, without the destruction of the transistors by a damaging Dirac 4-hole current in the supersystem.

The nonunitary overunity system can also be close-looped by *conventional* (simple) "clamped positive feedback" means if good isolation (e.g., optical isolation of the circuitry switching) is used in the feedback loops.

## 9.15 Some Instrument Considerations

### 9.15.1 Time Effects

As previously indicated, there are time-domain effects (potentials, forces, and currents) associated with a  $COP > 1.0$  EM system, particularly as the COP increases toward  $COP \gg 1.0$ . A useful method of indicating time-effects is to utilize a transistor in a circuit capable of measuring

recombination time in the transistor.<sup>282</sup> NASA has such circuitry available, but I do not have the reference at hand. We leave it as an exercise to the reader to explore that possibility.

For "very large COP" devices, ordinary watches, clocks etc. may be affected. Particularly significant is the slowing of timepieces in the presence of substantial time-domain effects due to substantial negative energy. In addition, for high gain devices (and for some at lower COP), the negative energy charge can build up in the local area, and may then require some days to dissipate. As we stated, in experiments years ago with Frank Golden, we experienced just such alteration of multiple kinds of clocks and watches in an area. It required four days for the negative energy charge in the area to gradually drain off (for the excess Dirac sea holes to gradually be filled with electrons, as the tempic potential gradually returned to normal).

Effects that were even more dramatic were exhibited in experiments conducted by Sid Hurwich in Canada some years ago {587}. In a series of experiments lasting a half-hour, Hurwich inertially jammed a police revolver so that a human finger could not pull its trigger. *The watches of the witnesses did not change their setting during that entire half-hour.* This cannot be understood by conventional electrical system analysis, but potentially it can be understood by supersystem analysis.

### **9.15.2 Calorimetry Is Taboo for Overunity System COP Measurement**

It is standard dogma that calorimetry is a "true" measurement of power, and is always accurate in the hands of a skilled practitioner. In general, that is true for a  $COP < 1.0$  system, where one is concerned only with *positive energy* in the input and output sections. However, with respect to  $COP > 1.0$  systems, nothing could be farther from the truth. Indeed, for a significant  $COP \gg 1.0$  system, a calorimeter is one of the most inaccurate instruments that can possibly be used.

As previously stated, all  $COP > 1.0$  EM systems produce a mixture of negative and positive energy in their output section. The higher the COP, the greater the percentage of negative energy and the greater the flux of Dirac 4-holes back to the input section. The output energy, immersed in a calorimeter, will both cool the water with its negative energy output fraction and heat the water with its positive energy output fraction. Hence, the calorimeter will show the *difference* between the water's simultaneous

<sup>282</sup> This suggestion is courtesy of John Schnurer some years ago, and is appreciated.

heating and cooling. If the calorimeter measurement is misinterpreted as the *total energy output*, this "definitive test" will always erroneously show  $COP < 1.0$ . After all, it itself already applies the decay mechanism for converting any overunity system to an underunity system.

The only good use of the calorimeter in an overunity EM system is to verify that negative energy is present, when comparing its measurements to more sophisticated electrical measurements of the system. It can be used along with other measurements to ascertain (1) the total energy output, whether negative or positive, (2) the difference in the two forms of energy output and the algebraic sign of the resultant (positive if calorimeter heated, negative if calorimeter cools), and (3) thereby help determine the output's energy fractions (positive energy divided by total energy, negative energy divided by total energy).

Any test group insisting on testing a purported  $COP > 1.0$  electrical system with a calorimeter as the *definitive statement of energy output* is totally devoid of knowledge of  $COP > 1.0$  systems and their phenomenology. Usually such "test groups" tend to regard themselves as "measurement experts" (which they well may be, in  $COP < 1.0$  positive energy systems!). That does not make the team even minimally knowledgeable or qualified in  $COP > 1.0$  system measurement. To the contrary, the team members have zero experience or knowledge of  $COP > 1.0$  systems. The proposed test group may consist of physicists, thermodynamicists, electrical engineers, technicians, or all four, but they still will have no knowledge or expertise in  $COP > 1.0$  EM power systems unless they have actually worked with such systems before, and at length.<sup>283</sup> This is particularly true of  $COP \gg 1.0$  systems. My advice to all  $COP > 1.0$  researchers is simply to keep the "calorimeter addicts" out of one's laboratory in the first place.

### 9.15.3 Other Instrumental aspects.

Here we just point out some simple and obvious things, familiar to the experienced researcher but sometimes not appreciated by the novice. One is usually dealing with nonsinusoidal waves, pulses, spikes and the like. As is well known, RMS meters are useless for measuring such nonsinusoidal electrical entities, since they are designed and calibrated to measure sine

<sup>283</sup> To date, we have found none who have actually worked with  $COP > 1.0$  electrical systems. We have, however, found quite a few who, though totally inexperienced with  $COP > 1.0$  systems and not knowledgeable, have regarded themselves as "real experts" in such systems. They claim to already know how  $COP > 1.0$  systems work and behave, and assume just ordinary electrical system phenomena.



waves only, or to measure DC. One must use a good differential sampling scope with multiple synchronized channels, with professional software to perform accurate integration under the curve, and with special differential probes for the scope. Simultaneous triggering of the multiple measurement channels on the same time line is required. The necessary high quality probe set may cost as much or more than the oscilloscope!

Dirac sea hole currents are generally not separately measurable, so one measures where the hole currents are not significantly present. Results may be compared to measurements where the hole currents are known to be present. When directly measuring hole currents, the conventional meters often read "backwards" and interpret a negative energy output at the system output section as subtracted from the positive energy, and interpret a negative energy output at the input section of the system as additional input electron currents from the external power supply. If the electron currents from the external power supply are not present, then measuring hole currents will draw electron currents from the power system inside the meter itself, resulting in a "backward measurement". Again, the meter actually will measure a real electron current, whether from the external power supply or from a conversion within the meter itself.<sup>284</sup>

Recombination time in semiconductors can sometimes be used in instrumented circuits to differentiate between negative hole current and electron current, by observing the change in recombination time due to the negative energy currents. It will differ from the change in recombination time due to positive energy currents.

Again, what is needed in the field is a set of solid, reliable instrumentation specifically developed for these peculiar measurement phenomena involving both positive energy and negative energy. To my knowledge, no such thoroughly designed and tested instrument package presently exists. Further, there are not even any standards for such, since there are apparently no standards for negative energy measurement at all.

## 9.16 Still Anomalous Aspects

Several aspects of COP>1.0 systems are still not properly understood. The behavior of curl-free A-potential, sometimes produced in such systems, is

<sup>284</sup> What is very much needed is a meter of sophisticated design where this "drawing of excess electron current from within the meter itself has been taken into account in the design, so that the meter functions correctly for either positive energy measurement or negative energy measurement.

a case in point. This type of energy can exhibit characteristics as if it were electrostatic energy, which my associates sometimes refer to as the "crawly stuff. It exhibits the characteristic of "crawling" all over the surfaces (outside and inside) of the objects in the area, including the scopes, producing internal electrostatics and possibly magnetostatics everywhere. This can easily destroy the amplifiers etc. in a good scope or an expensive meter. It is best to transform this field-free A-potential into an ordinary "EM field energy AC wave", and then utilize it in that fashion.

Scalar stress waves are also sometimes produced, leading to anomalous effects. This is best regarded as a "time-polarized" EM wave, or more accurately, as a combination of scalar (time-polarized) EM waves and longitudinal EM waves in 3-space. For macroscopic waves in  $COP > 1.0$  systems, the Mandl and Shaw 1:1 correlation between scalar photons and longitudinal photons can apparently be corrupted, so then one has "abnormal" (improperly correlated components which normally correlate to make "ordinary" EM waves). These abnormal EM scalar stress waves also exhibit the "crawly" phenomenon, and can be hazardous to one's instruments.

In addition, some instruments such as ionization counters, Geiger tubes, etc. read in the presence of such waves as if nuclear radiation were present (which it is not). Also, the individual time-charge history of a given instrument determines or substantially influences how the instrument reacts in the presence of the "corrupted" scalar stress waves. Essentially, at a given time any instrument has a small "time-energy charge" depending upon its past history. The corrupted scalar stress wave accomplishes further "time-charging" of the instrument, which combines with the initial time-charge to produce more time-charge, ordinary EM waves by scalar EM interferometry {588}, or abnormally correlated longitudinal EM wave emission.

In an ionization-measuring instrument, *ionization is ionization, by whatever means achieved.* And in the presence of the "abnormal" radiation and charging, ionization-type "nuclear radiation" instruments will vary from one to another, *depending upon the individual time-history of each instrument.* So from a group of identical instruments made the same day on the same assembly line, one may read anomalously and several others read normally. Or two may read anomalously, while all the rest read normally. A very good example of this anomalous measurement effect is seen in the rigorous electrolyte experiments in U.S. Navy research facilities at China Lake {589}. The present author has previously given an explanation of this time-charging and decay phenomenon {590}.

*Negative* energy reacts in different ways with different materials. The more nonlinear the material, the greater the effects and unpredictability of the interaction, as a rule of thumb. In a copper wire, Dirac hole current introduced into the wire will "eat" Drude gas electrons, reducing the "pressure" at that point or area in the wire. This "combining of electrons and causal Dirac holes is not normal pair annihilation, and radiation does not occur. Instead, the two curvatures of spacetime (one by the positive energy of the electron and the other by the negative energy of the Dirac hole before observation) interact and adjust.

The Drude gas in the copper further back toward the external power system still has normal (higher) gas pressure, and so the differential in pressure induced in the Drude gas will drive electrons from the "normal" pressure areas into the "reduced" pressure area where some of the Drude electrons disappeared after being "eaten" by the Dirac holes. To look at that in lattice hole terms, the "eating" of Drude electrons in a selected volume of the wire leaves positive ions, which are "lattice holes" vacated by the eaten electrons. So these excess positive charges attract electrons from further up the wire nearer the distant power supply, filling the lattice holes to bring the Drude gas back up to "normal". However, that also draws and "eats" additional power from the distant power supply. Meanwhile, the Dirac 4-holes fed from the input of the COP>1.0 system back into the power feed conductors continue to interact with the lattice and eat electrons to create more ions (lattice holes).

One may visualize the Dirac sea holes producing excess lattice holes, which then causes the Drude electron gas to change so that the "average" demand current increases. In short, we must also consider the effect of Dirac hole charges or currents upon the lattice material itself, and the structure of holes and electrons as charge carriers in the material lattice.

Semiconductors are very vulnerable to negative energy due to its disruption of their donor-acceptor and band gap design functions. With mild negative energy exposure, a semiconductor may just cease operation entirely and later recover when the negative energy application ceases, or it may fail and never recover. For pulsing, strong "opposing force pulses" (stress pulses) are created deep inside the semiconductor materials. In case of sharp pulsing, sometimes an exposed semiconductor will just suddenly explode in a nice little fireball about one foot in diameter. This along with some minute stinging fragments from the explosion assures that the COP>1.0 bench researchers stay alert and on their toes. Needless to say, when experimenting with COP>1.0 systems and circuits, one should exercise all safety precautions, including safety glasses, until the **"negative**

energy beasts have been tamed and controlled". One should not experiment with such things unless one is an experienced and safety conscious experimenter. One experiments at one's own risk.

Negative energy effects in coils and toroidal coils are largely still unknown, though we have outlined some of the major effects. For a normal helical coil, one can derive a concept of the effects by considering the lattice effects in the wire. In this case, introduction of hole current at one end of a helical coil will induce electron current from the other end and into the coil. Thus, hole current can be "switched" back and forth between the ends of a helical coil to induce an ordinary AC electron current in the coil, accompanied by normal magnetic fields etc. A point can be reached where the coil is actually in resonance with the frequency of the switching, and with the "seeming capacitance" of the hole current introduction in each switching. With the proper material in the coil and a keen balance between the negative energy capacitance effect and the normal positive energy induction effect, *in theory* a single coil can be turned into a self-oscillating, self-powering system.

With core material inside the core of a coil, the situation dramatically changes. Often the type reaction experienced will appreciably depend upon the core material, and changing the core material can dramatically change the effects upon the coil and the effects that the coil produces. One may even use dynamic changes in the core material to produce corresponding dynamic changes in the coil. A toroid may act differently from an ordinary helical coil, as does a flat (spiral-wound) coil. Here the experimenter must simply perform his own experiments to seek out and understand the phenomenology he uncovers.

For exploratory experimenting with core-filled coils, we advise strong caution and testing at very low power only. Sometime effects can apparently be experienced by the researcher (headaches, nausea, dizziness, etc.) It is suspected from some evidence (but not proved) that the core material's chemical characteristics can sometimes be "imprinted" upon the human body chemistry, from the novel radiation of a core-filled coil or some core-filled coils. This is particularly true in the presence of strong stress potentials, such as from bi-wound coils with fields in opposition, and particularly if the biwound coil contains a nonlinear material core. The nonlinear core induces modulation (multiplication) of the two waves, rather than linear mixing. Thus, the two waves are "locked together" to form a true stress potential and local spacetime curvature sets, when the biwound coil has a nonlinear material core. In short, one is now engineering pure general relativity, locally.

*Again, we iterate that the experimenter should be knowledgeable and take all safety precautions. He experiments at his own assumption of risk.*

The appearance of an extra stress potential (field-free) in a biwound coil is in fact a new Lorentz symmetrical regauging, and the equivalent of rotating the frame of the coil. As signals are introduced, this is the equivalent of continually changing the degree of the frame rotation, which is a general relativistic effect, with direct curvatures of spacetime being produced. In short, one is producing spacetime curvature and rotation engines, previously discussed.

The magnitude of the stress potential (field-free) falls off inversely as the distance. Thus one's body can be exposed to it, including the body chemistry, every cell and every part of every cell, the nervous system, etc. Placing signals on the biwound coil can conceivably result in slight variation of the scalar stress potential, including inside the body, and inside each cell and each part of each cell. Variation in the stress potential  $\phi$  in a little local region inside the body produces  $-\nabla\phi$ , which is an electric field  $E$ . The rate of change of this  $E$ -field then produces a magnetic field  $H$ .

Consequently, very minute EM fields are produced throughout the body and all its parts, or can be. It is as if the entire body is "electromagnetically washed" in internal EM fields throughout its matter, structures, and dynamics. The hydrogen bonding actions ever ongoing are particularly sensitive and can restructure appreciably in the presence of this stimulus. They can also "imprint" and take on a specific induced structure and dynamics, correlated to the persistent changes induced from the biwound coil. As can be seen, such EM biological effects have not been appreciably investigated and documented in the Western scientific literature. Hence our urging and insistence that the researcher use all caution, and our warning that he experiments at his own will and assumption of risk. Neither the publisher nor the present author is responsible for any accidents or blunders that may occur.

Capacitor effects also vary between types of capacitors, when applying negative energy or a mix of positive and negative energy. Some capacitor dielectric materials are also photo-refractive and are semiconducting materials, hence photoactive. The rich effects capable of being generated in capacitors — by EM fields, waves, potentials, and pulses of negative energy or negative and positive energy mixed — are largely unexplored and not catalogued.

Almost all modern permanent magnetic materials are also photo-refractive or photoactive materials as well, and many are semiconducting materials. Hence a rich variety of effects can be produced in permanent magnets by the introduction of negative energy fields, potentials, waves, and pulses.

As can be seen, a very rich combination of effects exists for "normal-appearing" coils, capacitors, semiconductors, and magnets when applying appreciable negative energy or controlled mixes of positive and negative EM energy. This is a still largely unknown materials science region, and one that has not been systematically and rigorously explored and catalogued, if at all.

In addition, there are effects from *pulsing* negative energy (Dirac hole currents) that are not completely understood. These appear to occur almost — or partially — at random, and also seem to be affected by the natural surroundings, by the various materials, etc. The "imprinting" phenomenon, when it occurs, seems to be augmented by pulsing, and sometimes by the pulse shape and pulse repetition frequency as well as the surroundings.

We also legally state that we are not responsible for any risks the researcher chooses to take, but are only alerting him to be very careful and use very good safety practices. Any experimenter is himself responsible for stringent adherence to good safety practice and common sense, and he legally assumes his own personal risks for all experiments he chooses to undertake.

Another effect to be alert to is the effect of "charging" the local area's supersystem with an altered active vacuum and curvatures of spacetime. This phenomenon is usually experienced as a "slow growth" of the COP of the system, over a long time (months or years). Tiller in private discussions has reported such phenomena in his detector built at Stanford University. Golden and I experienced such phenomena with a small COP>1.0 system Golden was developing. Over a period of five years, the system slowly increased its COP to about 2.0. Moved several hundred miles, the system then exhibited COP of about 0.9, but with occasional fluctuations of overunity temporarily.<sup>285</sup> Golden had gradually charged his local area with the "engine" or spacetime curvature operational and functional form of his unit. Thus in that repeatedly charging area, gradually the operation of the unit improved. We referred to this *engine-*

<sup>285</sup> In fact, Golden and I were astounded at these results, until Tiller explained it to us and explained his own experiences with "growing" his detector. Thanks to Professor Tiller, thereafter we had this new phenomenon firmly fixed in our lexicon.

*charging* of the environment with a particular effect or dynamic form as *kindling*.

The kindling or "charging to favor the dynamic form of the engine or device" problem, should it occur, is in fact usable because it is possible to produce it everywhere on earth, and fairly permanently. To use the kindling effect once discovered, the mechanism is to build several identical units. Keep the original unit working in the original area, and "outrigger" the others at radial distances as distant as possible, but maintaining COP>1.0 for the outriggers. Then simply run both the outriggers and the central unit, steadily. The "structural charge" will grow and reinforce at the outrigger locations, then spread on beyond the outriggers, and a much larger area will now be "charged with that dynamic form". With sufficient additional outriggering (three to five, or seven in an especially difficult case) where the successively internal outriggers are retained and operating, the charging will eventually spread around the entire Earth, and *it will become a permanent fixture of the Earth environment itself.*<sup>286</sup> Thereafter, anytime one of the units is turned on anywhere on earth, it will perform with its normal overunity condition. In other words, not only can one grow the dynamic form (engine) in a supersystem in a given locality, but one can also kindle it into the entire Earth's supersystem permanently {591}. One is strongly reminded of Feynman's observation that physicists with their big accelerators may in fact be partially creating their own reality. He pointed out that often the physicists look and look for a new, predicted particle. At last and after years of difficulty, finally a "glimpse" of the particle occurs in an accelerator and is reported. The physicists quickly crank up the other accelerators and look intensively, and — after some moderate difficulties — they find that particle. Thereafter, *every time an accelerator turns on and looks, that particle is readily seen, easily.*

The supersystem's spacetime is part of the local spacetime of the Earth, and all supersystems also interact with each other. As Kron put it {592}:

*"An electric network differs from all other types of non-electric networks in that it is always surrounded in all directions to infinity by an invisible dynamic electromagnetic field of its own creation. ... Each Inductance L produces its own magnetic field, each*

<sup>286</sup> We have proposed an application of this phenomenon to kindle and maintain a specific disease organism's "anti-engine" as a startlingly new kind of medical therapy for permanently eradicating a particular disease vector from the earth.

*capacitance produces its own electric field and each resistance  $R$  creates a thermodynamic field of its own. Moreover, there exists a continuous interaction between the magnetic, electric, thermodynamic, and radiation fields. Thus any correct and basic theory of the electric network must include all the parameters of its surrounding electromagnetic field and must satisfy all the field equations of Maxwell. The theory must also dovetail with the Hamiltonian and Lagrangean equations of dynamics containing both time and space derivatives, as well of the equations of irreversible thermodynamics. "*

So decades ago, Kron was struggling with the "supersystem" problem, in different terminology, and he eventually originated *diakoptics* {593}, an entirely new way of breaking the problem down piecemeal so it could be solved. But Kron strongly stressed that the interactions of the fields and potentials of a circuit and all its parts reach to infinity and have an  $n$ -dimensional set of degrees of freedom and an infinity of spaces. The fields and potentials of every charge reach to infinity (for those charges in matter from the beginning), and so every charge in the universe interacts with every other charge and its fields, potentials, and dynamics. Spacetime itself is filled with these interacting EM fields, potentials, waves, and dynamics. Little wonder that the horrendous set of ongoing EM interactions at every point in the vacuum has such incredible energy density and fluctuations. We may even regard the fluctuations and interactions as completely causal, but — with no information on each interaction — they must be treated as totally statistical. Ultimately nature confounds our Aristotelian logic and insists that, in the limit, one is dealing with 5-law logic as developed earlier in this book.

Since the earth near an ongoing  $COP > 1.0$  system experiment has innumerable electrical aspects, materials, etc., it follows that the surrounding earth is indeed in direct interaction with the experiment. It then follows that "slow conditioning" of the surrounding area should be possible, say, after some years as Golden experienced. It also follows that the effect diminishes in magnitude with distance from the experiment.

The "growth of the activation (kindling) to include the entire Earth" is a slow process, requiring years and much expense to aid the "spreading" — as the physicists may be experiencing, according to Feynman. But it is a doable.



We highly recommend that the researcher work on COP>1.0 systems that are not charge and location dependent, so that the kindling problem does not arise. We have assumed non-kindling COP>1.0 systems throughout most of this book.

# Chapter 10

## Cold Fusion: Low Spatial-Energy Nuclear Reactions at High Time-Energy

*"This book is about time. I would have liked to have named it Time, the Forgotten Dimension..." [Ilya Prigogine]. {594}*

*"The notion of time may be unfolded into an independent pure science... a science of pure time is possible." [Sir William R. Hamilton, 1837]. {595}*

*"...contrary to the conclusions of classical mechanics, there exist effects of potentials on charged particles, even in the region where all the fields (and therefore the forces on the particles) vanish." [Y. Aharonov and D. Bohm] {596}.*

*"...global behavior greatly modifies the very meaning of space and time. Much of geometry and physics is based on a simple concept of space and time, generally associated with Euclid and Galileo. In this view, time is homogeneous. Time translations may have no effect on physical events. Similarly, space is homogeneous and isotropic; again translations and rotations cannot alter the description of the physical world. It is quite remarkable that this simple conception of space and time may be broken by the occurrence of dissipative structures. Once a dissipative structure is formed, the homogeneity of time, as well as space, may be destroyed." [Ilya Prigogine] {597}.*

*"As we expand our observation, we extend our concepts. Thus the simple symmetries that once seemed self-evident are no longer taken for granted. Out of studies of different kinds of interactions we are learning that symmetry in nature is some complex mixture of changing plus into*

*minus, running time backward and turning things inside out.* " [T. D. Lee] {598}.

*"The desirable features of a system of units in any field are convenience and clarity. For example, theoretical physicists active in relativistic quantum field theory and the theory of elementary particles find it convenient to **choose** the universal constants such as Planck's quantum of action and the velocity of light in vacuum to be dimensionless and of unit magnitude. The resulting system of units (called 'natural' units) has only **one** basic unit, customarily chosen to be length. All quantities, whether length or time or force or energy, etc., are expressed in terms of this one unit and have dimensions which are powers of its dimension. There is nothing contrived or less fundamental about such a system than one involving the meter, the kilogram, and the second as basic units. It is merely a matter of convenience."* [J. D. Jackson] {599}.

[Violation of Second Law of Thermodynamics] *"We experimentally demonstrate the fluctuation theorem, which predicts appreciable and measurable violations of the second law of thermodynamics for small systems over short time scales... Our results show entropy consumption can occur over colloidal length and time scales."* [Evans et al.]<sup>287</sup>

[Implications] *"This result has profound consequences for any chemical or physical process that occurs over short times and in small regions."* [Evans et al.]<sup>288</sup>

[Implications] *"The smaller a machine is, the greater the chance that it will run backwards."* [Evans et al., *ibid.*]

[Implications] *"Physicists knew that at atomic scales over very short periods of time, statistical mechanics is pushed*

<sup>287</sup> G. M. Wang, E. M. Sevick, Emil Mittag, Debra J. Searles, and Denis J. Evans, "Experimental Demonstration of Violations of the Second Law of Thermodynamics for Small Systems and Short Time Scales," *Phys. Rev. Lett.*, 89(5), 29 July 2002, 050601.

<sup>288</sup> BBC News, 18 July 2002, <http://news.bbc.co.uk/1/hi/scitech/2135779.stm>.

*beyond its limit, and the second law does not apply. Put another way, situations that break the second law become much more probable. ...the new experiment probed the uncertain middle ground between extremely small-scale systems and macroscopic systems and showed that the second law can consistently be broken at micron scale, over time periods of up to two seconds."* [Chalmers]<sup>289</sup>

## 10.1 Explaining Time as Energy

See Chapter 1, paragraph 1.1.3 and 1.4.1; see also Chapter 2, paragraph 2.1.3. As highlighted in the quotation from Jackson {599}, it is well known that the fundamental units chosen to model physical phenomena are arbitrary. In a physics model whose only fundamental unit is the joule, time is obviously modeled solely as a function of energy, just as mass is modeled today as a function of energy — hence the term "mass-energy". We may also equally well use the term "time-energy", since in a model using the joule as its only fundamental unit the second is purely a function of energy. Specifically, for our purposes  $1 \text{ sec} = 9 \times 10^{16}$  joules of spatial energy, compressed by the factor  $c^2$  and placed on the 4th Minkowski axis to constitute one second of time. If the compressed spatial energy had been left in 3-space, it would be recognized as *mass*. For our purposes, *time* has the same energy density as mass.

The flow of time becomes a special form of EM energy flow, analogous on the fourth axis to mass flow (translation) in 3-space. Further, as previously pointed out the overall flow of time has extensive internal structuring of component time-energy flows. However, time-flow is in the imaginary plane or connected with it, since in Minkowski space the 4th dimension is modeled as *-ict*. Note that the only variable in *ict* is the *t*, hence anything varying on the fourth axis is a variation of time and time-energy *a priori*.

Further, we can apply conservation of EM energy to the time domain as well as in 3-space. And we can have "broken symmetry" in time-energy flow as well as in 3-spatial energy flow, so long as the net energy flow is conserved. The most fundamental conservation of energy law is giant negentropy: the automatic circulation of energy from the time domain into 3-space via decompression by the negative charge, thence the slight flow of 3-space energy to the positive charge where the 3-space energy is re-

<sup>289</sup> Matthew Chalmers, "Second law of thermodynamics 'broken'." *New Scientist*, 19 July 2002, <http://www.newscientist.com/news/print.jsp?id=ns99992572> .

compressed, thence from the positive charge back into the time domain.<sup>290</sup> That was our solution to the long-vexing problem of the source charge and its associated 3-space fields and potentials and their 3-space energy. From special relativity, one already knows that time can dilate and then *un*-dilate, but each action is associated with an appropriate change in spatial energy. While that change in spatial energy can be kinetic, it does not have to be. It can be a change in potential energy instead. In short, a static object rotates its frame with respect to the observer (lab) frame, whenever it absorbs or emits potential energy.

We also pointed out the connection of time-energy to electromagnetics and to quantum field theory, via the four polarizations of the photon considered to travel in the  $z$  direction in 4-space. These four polarizations are with the energy vibrating along  $x$ -,  $y$ -,  $z$ -, and  $t$ - respectively. Vibration of the spatial energy of the photon along the  $x$ - or  $y$ - axis gives an ordinary transverse photon. Vibration of the spatial energy of the photon along the  $z$ - axis gives the longitudinal photon. Vibration of the time-energy component along the  $t$ - axis gives the scalar or time-polarized photon. We assume a similar four polarizations for EM waves in 4-space.<sup>291</sup>

## 10.2 Mechanism Generating Flow of a Mass through Time

As we covered in the referenced paragraphs in Chapters 1 and 2, the fundamental generatrix of the flow of a mass through time — and the structuring of that flow — is the total photon interaction with the mass and all its parts. This includes both observable and virtual photon interactions.

As a recapitulation: Mass  $m$  does not exist in time, since it is an observable and observation is the imposition of  $d/dt$  upon spacetime LLLT, removing the  $T$  to give a "frozen LLL snapshot." In short, mass  $m$  is an *effect* (of the iterative very high speed observation process), not a *cause* (which is an *input* to the observation process). This is why all observation is 3-spatial rather than spatiotemporal: it yields the 3-space *effect* (at a given time, of a

<sup>290</sup> Note the relationship with such things as time dilation, which represents a broken time-flow symmetry, where net energy flow from the time domain to the 3-space domain occurs. Hence time dilation is associated with the increase of spatial energy, such as kinetic energy due to the relativistic velocity of the moving object.

<sup>291</sup> In this book, we have limited our discussion to four dimensions. If we model in five or more dimensions, then additional symmetries and broken symmetries **are** possible, as are new kinds of multi-dimensional EM waves.

given interaction), not the 4-space cause of the interaction and not the ongoing 4-space interaction.

By absorbing and emitting photons, observed mass  $m$  may be said to move through time in a succession of  $m \Rightarrow mt \Rightarrow m \Rightarrow mt \Rightarrow m \dots$  jumps, each involving change of physical state as a photon is absorbed by  $m$ , changing it to  $mt$  which is nonobservable. Then a photon is re-emitted by  $mt$ , changing it back to  $m$  and completing another observation with this new  $m$  as the output (effect). We note that masstime  $mt$  is as different in nature from mass  $m$ , as impulse  $Ft$  is from force  $F$ . In mass  $m$ , every tiniest differential  $dm$  is also interacting with photons continuously (even though they may be *virtual* photons), hence  $dm$  also exhibits its own "digital flow through time" as a part of the structure of the overall flow of the parent mass through time.

Interaction primarily with the  $mt$  state yields wavelike interactions. Interaction primarily with the  $m$  state yields particle-like interactions. This is proposed as a possible resolution of the wave-particle duality problem, which has never been resolved but just accepted without further argument. Previous consideration of wave-particle duality has assumed that "mass has two states, one particulate and the other wavelike". We correct that assumption by pointing out that two different "states in which mass exists" are involved, and the two are quite different: one is mass  $m$ , and the other is masstime  $mt$ . We stress the function of the myriads of virtual photon interactions during an  $mt$  state, where an observable photon has not yet been re-emitted. These virtual photon reactions create streams of virtual  $dm \Rightarrow (dm)dt \Rightarrow dm \Rightarrow (dm)dt \Rightarrow \dots$  on all the differential parts of mass  $m$ , which creates the rich structuring inside the "time-flow" of the overall observable mass  $m$  through time. The rich dynamics of the  $dm \rightarrow (dm)dt$  streams also accounts for the seeming existence of mass  $m$  as a set of 4-dynamics which interpret as a set of waves. We note that the emitted photon carries with it the internal structuring of the spatial energy domain and the time-energy domain. Herein we have the basis for the Kaznacheyev's demonstrated electromagnetic induction of cellular damage and disease at a distance.<sup>292</sup>

Finally, we tentatively assume that, prior to its interaction, the antiphoton carries negative spatial energy and positive time increments, while the photon carries positive spatial energy and positive time increments. In a

<sup>292</sup> Vlail Kaznacheyev and L. P. Mikhailova, *Ultraweak Radiation in Intercellular Interactions*, [in Russian], Novosibirsk, 1981.

very small region where an excess of antiphoton interactions occurs temporarily, time-reversal occurs and the physics "runs backward". It has recently been experimentally proven that such "reversing" of the physics processes occurs up to micron size and for times up to two seconds.<sup>293</sup>

## 10.3 Time-Polarized EM Waves and Longitudinal EM Waves

### 10.3.1 Waves, Photons, Spacetime Curvature, and Observation

Spacetime (ST) curvature involves not only the change of *spatial* energy density of local spacetime but also a change of its *time-energy* density. That component of the total ST curvature due to time-energy density change — i.e., time-polarized EM photons and waves — can be far more powerful, because of the enormous energy density of the time-energy compared to the far less dense 3-spatial energy. As previously stated, time may be regarded as having the same energy density as mass, except that the highly compressed 3-spatial energy is moved to the 4th Minkowski axis to constitute "time" rather than being left in 3-space to constitute "mass".

Hence ST curvature can be made very powerful when one uses longitudinal phase conjugate EM *wavepairs*, as shown by Whittaker {600} in 1903 with slightly corrected interpretation as argued by the present author {615}. Each longitudinal EM wave in 3-space is accompanied by a precisely coupled time-polarized (scalar) EM wave in the time domain, which latter wave is a longitudinal EM wave on the fourth Minkowski axis involving changes in the *t* variable in the axis *-ict*. We previously discussed the giant negentropy that this represents with respect to the source dipole. At various times in the past, we have emphasized the time-domain aspects of the coupled phase conjugate longitudinal EM wave-pair by calling such a coupled wave by terms such as *time-density EM waves*, *time-polarized EM waves*, etc. These terms imply additionally altering and structuring the *time density* and *time-energy density* of spacetime rather than merely altering and structuring its *3-spatial energy density*. Such time-density induced ST curvatures may be nearly  $10^{17}$  times stronger than ordinary spatial energy density ST curvatures {601}.

Interestingly, at least one researcher — Matsumoto {602} — has realized the basic implication in cold fusion processes of using the strong EM force

<sup>293</sup> See footnotes 287, 288, and 289.

as the agent of spacetime curvature. He has shown consistency of the postulated EM-induced ST curvature approach with some important cold fusion results. However, Matsumoto has utilized the conventional interpretation of spacetime curvature due to alteration of *3-spatial energy density* of spacetime. This misses the primary time-density functions, but does include the resulting spatial-energy functions after transduction from time-energy to spatial-energy. His work, however, does support the involvement of a more intense form of energy in the cold fusion effects.

There are intriguing but still mysterious relationships to be noted between cold fusion and deep astrophysical mechanisms. Continuing reference is made to these similarities, including black holes and white holes. Black holes and white holes involve spacetime curvatures — extreme, but still spacetime curvatures. So one would suspect that the entire scale of spacetime curvature — including black holes and white holes in the limit — should be of interest to cold fusion researchers, since in their use of time energy they are inadvertently involving more intense forms of energy than ordinary spatial EM energy.

Most nuclear scientists and even some relativists seem unaware of the much more powerful spacetime curvature effects obtained by alteration of the *time density* of spacetime rather than just its *spatial energy density*. Physicists have largely omitted specializing on time density ST curvatures because they have largely omitted the absorption and emission interactions of the time components transported by photons and EM waves.

Longitudinal EM phase conjugate wavepairs (each wavepair a coupling of a time-polarized EM wave and a longitudinal 3-space EM wave) of the type shown by Whittaker {600} in 1903 involve net *time density oscillations* as well as 3-spatial energy density oscillations, according to our reinterpretation. The infolded "inner EM content" of all conventional EM potentials, fields, and waves thus contains extraordinary dense time-energy, normally lost in the  $d/dt$  observation interaction.

In short, the infolded "internal Whittaker electrodynamics is a pure "general relativistic electrodynamics" and a unified field dynamics. Further, it can be engineered, which leads to startling new physical processes previously thought to be impossible and forbidden by the laws of nature.

Prior to observation, the internal highly compressed time-energy structures associated with the interior EM structure of all conventional EM potentials, fields, and waves are extremely powerful spacetime curvatures.



In short, all "conventional" electrodynamics has an internal structure of strong spacetime curvatures and dynamics.

Organization and patterning impressed on, or inserted in, this internal structuring can provide extraordinary actions in materials, living biological systems, cells, etc. Adding deterministic structuring inside these normal EM entities is referred to by Russian energetics weapon scientists as engineering the *information content of the field*. This is the approach behind deliberate engineering of *spacetime curvature engines*, or vacuum engines — or just "engines" for short.

In theory, any physical change to a mass can be engineered by inserting such "engines" into the mass. Any mass-energy is a mass-energy EM potential with an internal structuring (engine) for all the mass's internal dynamics. This engine is referred to as the *resident engine* of that mass (and all its dynamics). Introducing to a given mass a potential with a desired "delta engine" structure, results in the superposition of the two potentials, resulting in exchange sharing of the engines. In that manner, a desired "delta engine" diffuses into the mass's potential structure and its resident engine, changing it to a new resident engine which now acts on the mass at every level to change it. Potentials superpose, and their engines diffuse and superpose as well. Direct engineering of matter — even inside the nuclei and inside the nucleons themselves — can be performed by introducing the desired engine or engines for the changes desired.

This area has been highly weaponized by one or more nations. E.g., the Russians — in several decades of so-called "microwave radiation of the U.S. Embassy in Moscow — induced health changes and diseases in U.S. personnel in the Embassy by inducing deliberate "disease engines". Such EM-induced diseases and health changes were generated in the zones where the potentials were field-free, and therefore stable for stable engine diffusion.

Note that the common scalar potential decomposes by Whittaker's 1903 decomposition {600} into the longitudinal EM wavepairs we are speaking of. Also note that, per a second paper by Whittaker in 1904 {91b} that initiated superpotential theory, all EM fields and waves can be decomposed into two scalar potential functions. Each of those base potentials involved in the potential functions further decomposes by Whittaker 1903 into a harmonic set of phase conjugate longitudinal EM wavepairs as previously discussed. Therefore, the infolded EM inside all the "conventional" EM fields, waves and potentials is indeed a highly organized set of such bidirectional longitudinal EM wavepairs and thus a

highly organized set of extreme localized ST curvatures. In other words, it is comprised of these special "engines" of deterministic spacetime curvatures and their dynamics.

Constructing the potential by assembling one's own set of phase conjugate longitudinal EM wavepairs to form it, one can insert any kind of ST curvature set — any kind of vacuum engine desired — inside the base potential(s), hence inside the two potential functions comprising a given set of EM fields and waves utilized as "carriers". The specific internal structure of a "carrier" radiation field or potential designed to carry such engines is called the "information content of the field".<sup>294</sup> The Russians have long had a disinformation campaign to suggest that the term refers to conventional spectral analysis. It does not.

Johns Hopkins scientists did detailed measurements inside the Embassy and confirmed that all the anomalous health changes and diseases had occurred only in areas where the EM fields B and E were absent. That is, the health changes occurred only where the potentials were field-free and therefore stable and unchanging, so that an exposed body was immersed in a steady sea of "vacuum engines" being diffused throughout the targeted body's EM potentials in and on its cells, its cellular membranes, etc.

In general relativistic terms, every physical set of changes and altered dynamics (syndrome) of a specific disease has a specific *delta* set of spacetime curvatures and dynamics associated with it, which interacts on the body, its chemistry, its electrodynamics, its cells, etc. A desired set of

<sup>294</sup> Indeed, in theory one can *construct, functioning robotic systems* of these internal engines. In clandestine Russian weapon research, it appears that at least elementary "causal robots" of such internal engine type have been developed and tested. In a sense, these are the ultimate "nanobots" made of infolded longitudinal EM waves and their dynamics. In theory, command and control functions (via longitudinal EM wave communication) can be included, as can certain kinds of weapons effects based on scalar interferometry. The eventual development of such startling weapons seems intended to produce an army of eerie "internal EM" robots which can be "sent in" *through the interior of EM fields, waves, and potentials*, to targets anywhere on earth, beneath its surface, in space, or beneath the ocean. This may be intended to become the ultimate robot or "high tech" warfare, and it is also the ultimate "information" warfare. There are no shields against this type weaponry. Defense, however, is accomplished by first using longitudinal wave "scanning" to pick up and track the systems, much like radar picking up aircraft. Once detected, scalar interferometry is utilized to disrupt and destroy them in place. Progress on these robotic weapon systems appears to be well along, as does progress on their countering longitudinal EM wave weapons.

ST curvature deltas for a given disease was inserted inside the base potentials in a combined Whittaker 1903 and 1904 decomposition of the stable field-free potentials in the Embassy. The Russians thus induced the desired engines for induction of the specifically desired disease(s) in the assigned personnel in those field-free potential zones in the Embassy. The purpose was to use the tests as (i) a guaranteed means to provoke high level U.S. governmental attention, and (ii) a probe to see if the U.S. knew about such technology and had developed defenses. Other tests of such disease induction in entire populations have also been conducted, but these are beyond the scope of this book.

We point out one very important thing: the cells of the body have their normal "resident engines" and resident engine dynamics inside their internal fields and potentials and waves. For any specific disease or disorder condition, there exists a specific associated change (delta) in the normal set of vacuum engines and their dynamics, in the cells and the body. In short, there exists a specific "delta engine" for any cellular disease or disorder, added to the normal engine.

*It is not the immune system that heals.* Instead, it is the cellular regenerative system. The natural healing method used by the cellular regenerative system is not chemical. The regenerative system uses the phase conjugate wavepair composition of increased scalar potentials (on cellular membranes and every part of the cell) to "pump" the cells in the time-domain. This creates an "anti-engine" for the specific disease delta or disorder, and it slightly amplifies this anti-engine within the limited capabilities of the body. This action places this amplified anti-engine also into the stricken cells' engine complex. Engines superpose, just as do potentials. This action by the regenerative system has the effect of slowly producing complex anti-forces in the body and inside the cells themselves, eliminating the detrimental engine delta, restoring the normal resident engine and thus time-reversing the stricken cells back to a previous healthy condition. It does not kill pathogens at all; that is the function of the immune system. In the 1960s and early 1970s, Antoine Priore in France demonstrated remarkable cures of terminal tumors, infectious diseases, clogged arteries, and other disorders in laboratory animals,<sup>295</sup> unwittingly

<sup>295</sup> See (a) A. Priore, *Guerison de la Trypanosomiase Experimental Aigue et Chronique par L'action Combinee de Champs Magnetiques et D'Ondes Electromagnetiques Modules* [Healing of intense and chronic experimental trypanosomiasis by the combined action of magnetic fields and modulated electromagnetic waves], Priore's thesis submitted in candidacy for the doctoral degree, 1973. The thesis was rejected when the project was suppressed. See also (b)

amplifying the body's own master regenerative mechanism. His work was suppressed in the mid-70s.

Check our website, [www.cheniere.org](http://www.cheniere.org), for a 119-slide "porthole" briefing on the present author's extension whereby specialized mixes of ordinary EM waves can be used to initiate and perform this "delta engine elimination" healing process, and it can be highly amplified well beyond the body's normal healing capabilities.

In 1998 we seriously proposed to the DoD, the USAF, the NIH, and other U.S. government institutions that a crash development program be initiated to develop portable units capable of rapidly (5 minutes per patient) treating mass casualties from coming terrorist attacks with weapons of mass destruction such as anthrax, smallpox, bubonic plague, Ebola virus, etc. Sadly, no one in the U.S. government had the foggiest notion of what we

"Le Probleme Priore," *Rapport de la Commission de l'Academie des Sciences a Monsieur le Ministre d'Etat charge de la Recherche et de la Technologie*, 1982, p. 1-22; (c) Antoine Priore, "Precede et dispositif de production de rayonnements utilisables notamment pour le traitement de cellules vivantes," [Procedure and Assemblage for Production of Radiation Especially Serviceable for the Treatment of Living Cells], Republique Francais Brevet d'Invention P.V. No. 899.414, No. 1,342,772, Oct. 7, 1963; (d) Antoine Priore, "Method of producing radiations for penetrating living cells," U.S. Patent No. 3,280,816, Oct. 25, 1966; (e) Antoine Priore, "Apparatus for producing radiations penetrating living cells," U.S. Patent No. 3,368,155, Feb. 6, 1968; (f) A. J. Berteaud and A. M. Bottreau, "Analyse des rayonnements electromagnetiques emis par l'appareil Priore," [Analysis of the electromagnetic radiations emitted by the Priore apparatus], D.R.M.E., 1971, p. 3-12.; (g) R. Courrier, "Expose par M. le Professeur R. Courrier, Secretaire Perpetuel de L'Academie des Sciences fait au cours d'une reunion a L'Institut sur les effets de la Machine de M. A. Priore le 26 Avril 1977," [Presentation by Professeur R. Courrier, Perpetual Secretary of the Academy of Sciences, made at the meeting of the Academy on the effects of the machine of M. A. Priore]; (h) R. Pautrizel, A. Priore, M. Dallochio and R. Crockett. (1972) "Action d'ondes electromagnetiques el de champs magnetiques sur les modifications lipidiques chez le Lapin par l'administration d'un regime alimentaire hypercholestrole." [Action of electromagnetic waves and magnetic fields on provoked lipidic modifications in the **rabbit** by the administration of an alimentary hypercholesterol diet.] *Compt. Rend. Acad. Sci. (Paris)*, Vol. 274, 1972, p. 488-491. The same university that rejected Priore's doctoral thesis in 1973, accepted a doctoral thesis on the same subject some 11 years later due to the persistence of Pautrizel: See (i) Eric Perisse, *Effets des Ondes Electromagnetiques et des Champs Magnetiques sur le Cancer et la Trypanosomiase Experimentale [Effects of Electromagnetic Waves and Magnetic fields on Cancer and Experimental Trypanosomias]*, Doctoral thesis, University of **Bordeaux** No. 83, March 16, 1984.

were discussing. At NIH, we never got out of their "policy" (i.e., "spin control") department. Not a single capable scientist reviewed the extensive package. The attack on the World Trade Center and the Pentagon on Sept. 11, 2001 is just a forerunner of that which is to come. We could have been prepared to save hundreds of thousands of Americans, even millions. We shall not be ready, and the first really professional anthrax or smallpox (or camel pox, which is easily available and almost exactly the same as smallpox) attack on a major U.S. population center may leave from one to three million Americans dying in the streets and in their homes. Presently nothing will save them. It could have been different.

### 10.3.2 Photons and Waves in Minkowski Spacetime

Photons are made of angular momentum (action); i.e., of *energy  $\times$  time*. Waves, being made of photons, carry both spatial (decompressed) energy and time (highly compressed) energy — although physics has largely omitted the *time-energy-carrying* aspect, and only accounted for the *spatial energy-carrying* aspects. An EM wave in space is actually a wave of the particular spacetime curvatures that produce angular momenta in interacting charged masses. The standard notion of E and B fields at right angles in a plane in 3-space, traveling along the  $z$ - direction and with the plane orthogonal to  $z$ -, and with E and B field vectors oscillating back and forth, is nonsense, as acidly commented upon by Romer {603}, the former editor of *American Journal of Physics*.

Nonetheless, using the standard way of modeling the "transverse" EM wave: In conventional electrodynamics, a *transverse EM wave* is one where the 3-spatial energy density is considered to be varying rhythmically at right angles to the direction of wave propagation, and the time-density is assumed to be non-varying, or at least altered only by special relativistic considerations in certain cases.<sup>296</sup> A longitudinal EM wave has its spatial energy density fixed in  $x$ - and  $y$ - directions, and its energy density is oscillating along  $z$ -, the direction of wave propagation, by a "compression" and "rarefaction" process much like squeezing an accordion. This, however, leads to a "galloping" motion where the wave is alternately very superluminal and very subluminal at given instants, but moving at an *average velocity of  $c$*  {604}. On the other hand, a *time-density (scalar) EM wave* by definition is not varying in its 3-spatial energy density, and

<sup>296</sup> We point out that a wave of varying spatial energy density is moving in a varying curved ST a priori, by general relativity. If the "wave" were in a flat spacetime as normally assumed, the EM flat spacetime would eliminate the EM wave itself. **This** has been particularly pointed out by Sachs and by Evans.

therefore is not varying in  $x$ -,  $y$ -, or  $z$ -. Instead, the energy is in the form of time-energy, and its variation is in time density. So its energy density is oscillating along the fourth Minkowski axis,  $ict$ , as an oscillation of the energy density of the variable  $t$ . It is therefore polarized in the  $t$ - direction.

### 10.3.3 Time-Charging, Internal Structuring, Vacuum Engines, and Diffusion

Photon interaction as a *spatial* energy collection or energy exchange process is well known in physics. However, the time-charging or time-excitation interaction between the mass and the time component carried by the photon is usually ignored.

As is well known, an atomic electron that absorbs a transverse photon increases its spatial energy and changes into an excited spatial energy state. When the electron subsequently "decays" from that excited energy state to a lower state, the spatial energy differential between the two states is emitted as the spatial energy component of an emitted photon. This is the *spatial energy density* reaction of a transverse photon with an absorbing and emitting mass particle.

Unaccounted for by physics, at the time of the energetic excitation of the mass (i.e., when the photon is absorbed), a time excitation — time charging — also occurred because the time-component of the absorbed photon is also attached to the mass, converting it to *masstime*, a new entity. Re-emission of the photon is accomplished by the decay of both the *spatial energy* excitation and the *time-energy* excitation. In the previously excited state after photon absorption, however, one did not have the entity "mass", but the entity *masstime* having greater topology. If mass is an observable and taken to be 3-spatial (as is conventional), then photon absorption and emission oscillates between 3-space and 4-space effects, generating both spatial energy and time-energy (or *angular momentum*) excitation and decay.

Further, only *masstime* emits a photon. This immediately casts a very different light on such things as radioactive elements, which are in an initially excited state. Discussion of this aspect, however, is beyond the scope of this treatise.

On the other hand, a *scalar (time-density)* photon {605, 606} has a rather different interaction, regardless of how physics presently treats it. Any atomic electron at any energy level is continually receiving and emitting virtual photons - transverse, longitudinal, and scalar- in its virtual photon exchange with the energetic vacuum. Hence it is continually "connecting to" or "absorbing" time components, thereby changing its nature from

mass to masstime, back to mass, back to masstime, etc. Not only the entire electron but also each differential piece of it is performing that dance between mass and masstime. This is a continual changing from 3-space to 4-space and back. There thus is a violent "chatter" of the electron (and each differential piece of it) in the myriad levels of its *time* exchanges, giving it

- (i) An average rate of time component exchange,
- (ii) An average "time-charge", and
- (iii) A dynamically changing, specific structuring of its time components.

Whenever a mass absorbs an observable photon, the mass converts to masstime, with an "extension in time" as well as extension in 3-space. During the time-interval created in the masstime, myriads of virtual photons are absorbed and emitted by that mass component of the masstime entity. Hence every  $dt$  portion of the masstime state after observable photon absorption, is "internally structured" by the entire virtual photon interaction set's  $At$ 's occurring within that time interval.

By tailoring at least the larger elements of this internal structuring of the masstime state's virtual photon bombardment, by a deliberately induced virtual photon bombardment, the emitted photon from the masstime decay will carry away with it a desired internal "vacuum engine" structure of organized curvatures of spacetime. In short, two potentials superpose; that is one of their primary features. When they superpose, they also diffuse their internal structures (internal vacuum engines) into each other.

We speak of the *diffusion of a specific vacuum engine* placed in one interacting EM potential, field, and or wave as *dimensioning* the potential, field, or wave. Adding a dimensioned potential, field, or wave to other potential(s), field(s), or wave(s) diffuses the dimensioning (the engines) between all of the participating entities. With steady radiation of such dimensioned signals into a targeted object, field, wave, or potential, the dimensioning is gradually created (kindled) in the target, simply diffusing throughout it and gradually accumulating. If the irradiating signal carries a specific disease — e.g., necrotizing fasciitis — then gradually in the irradiated body there will emerge all the symptoms of necrotizing fasciitis. If the irradiating signal carries a specific disease antiengine — e.g., for necrotizing fasciitis — then gradually the necrotizing fasciitis condition will be eliminated, with the disease organisms also being eliminated.

This is a more fundamental extension of the disease vector concept. Not only can a disease vector be induced by a physical organism such as a virus or bacterium, but it can also be introduced by simply capturing the fundamental vacuum engine pattern of the disease and using it to condition or dimension signals used to steadily irradiate the targets.

This is the explanation of the Kaznacheyev experiments {607}: thousands of experiments performed by Vlaiil Kaznacheyev and his colleagues demonstrated the induction of almost any kind of remote specific cellular death and disease patterns in targeted cells, by absorption of radiation emitted from appropriate dying or diseased "emitter" cells with that condition, if the experiments were performed in the dark.

Instead of looking for biogenesis causes in amino acid precursors to cellular life in meteorites etc., one might well look into the *vacuum engine structures* inside the light from the sun, the planets, the stars, and the universe in general. E.g., dead sperm can often fertilize female cells, if not too much physical damage and deterioration to the dead sperm cells has yet occurred. This is understandable, since for a time a dead but undamaged sperm cell will have the same resident engine as a living sperm cell.

#### 10.3.4 Some Cosmological and Gravitational Effects

Each of the observable-sized dt's in all the serial masstime excited states of the mass moving through time, is internally and precisely structured. **The** precise time history of any mass — together with all its interactions, experiences, etc. — is present inside the time stream of ongoing interactions of that mass with photons. These virtual photon changes are in fact deterministic and come from every part of the universe, as shown by Puthoff {608} in his self-regenerative cosmological feedback cycle. We have merely extended his cosmological feedback to include the time **domain** as well as the energy domain. We hypothesize without further **discussion** that this internal structuring of the time-domain for every mass or object will eventually be connected with the quantum concept of the **geometric** phase {609}.

When a transverse photon interacts with a mass in the presence of other **photon** interactions, the mass can act as a phase conjugate mirror and form the phase conjugate replica photon (an antiphoton). For a longitudinal **photon**, the antiphoton *prior to observation* is a scalar photon. We propose that in the unobserved causal state the photon and antiphoton can couple (strong interpretation of the distortion correction theorem) and form a spin-**2 graviton**. According to quantum field theory, one may already interpret



the common scalar potential as being comprised of such spin-2 gravitons {610, 611} if we speak of the situation prior to observation.

As opposed to the accounted *spatial energy charging* of the familiar transverse photon interaction, the longitudinal photon interacting with mass will cause immediate phase conjugation by the mass because of the accompanying scalar photon (accompanying antiphoton prior to observation). When one pumps with longitudinal EM waves, one also inadvertently pumps with time-polarized EM waves simultaneously.

From its background "time-energy pumping" in its vacuum exchange, the mass forms the phase conjugate replica, which couples to the incident longitudinal EM photon. This forms (wave view) bidirectional longitudinal EM wavepairs (conjugate pairs), comprised of (particle view) internal coupled longitudinal photon-antiphoton pairs. Each of those internal photon-antiphoton pairs is a spin-2 graviton.

Each such conjugate longitudinal wavepair actually contains a time-density (time-polarized) or scalar EM wave. So the interaction of LWs and their accompanying scalar waves immediately initiates the formation of time-density waves, which then primarily perform a time-charging interaction. In addition, even for an equilibrium time-charging state, the "masstime" state of the interacting electron contains a specific structure of the time elements in the electron-time's time component. Each of these infolded time elements is also time-charging the electron.

### **10.3.5 Charging and Excitation Considerations For Cold Fusion Purposes**

So there are several new types of charge or excitation that are involved in cold fusion and other phenomena. One may speak of charging and excitation such as gravitational charging, time charging, time-energy excitation, time-energy charging, etc.

Both the longitudinal photon and the scalar (time-polarized) photon are in fact known in physics, but usually neglected, at least at the end of calculations. E.g., Gray {612} puts it this way about the four kinds of photon polarizations and the habitual elimination of the higher ones:

*All that quantum theory can say is that there are two transverse photons, a longitudinal photon and a scalar photon. It must be decided by other means which are "desirable" states and then it is customary to "eliminate" the longitudinal and scalar photons by invoking a*

*subsidiary condition, now somewhat weakened from the Dirac form.*

For our purpose in examining the cold fusion experiments, there exists a completely unsuspected "time-charge" set of excited states for an atomic electron, a proton (as in an H<sup>+</sup> ion), etc.<sup>297</sup> There also exists a "time-structuring" of the time-charge excited time-state, which we will see is important in certain highly anomalous instrument phenomena. Uncovering this time-charging and time-structuring interaction has been one of the major results of this author's long effort to decipher the functioning of the healing (cellular regeneration) system of the body as well as his efforts to decipher the fundamental nuclear transmutation mechanism in cold fusion transmutation interactions at feeble *spatial* energy.

In summary: For longitudinal photon interaction, the atomic electron "absorbs" the longitudinal photon and its accompanying scalar photon, being simultaneously spatial-energy excited (charged) by the longitudinal photon and time-energy excited (time-charged) by the scalar photon. This time-excited state (of masstime) then subsequently decays, emitting a longitudinal photon accompanied by a scalar photon in the process.

<sup>297</sup> See again footnotes 287, 288, and 289. From our mechanism propelling a mass through time, time-charging and discharging play the causal role. The acquisition of  $dt$  by mass  $m$  produces masstime  $mt$ , then the subsequent photon emission decay of  $mt$  back to  $m$  produces "propagation of mass  $m$  forward through time" by one "jump". Time charging with  $-dt$  and subsequent photon emission is what produces "propagation of mass  $m$  backwards through time" by one "jump". Evans et al. proved that even up to the micron scale physical particles and their dynamics can run backwards in time for up to two seconds or more. The fluctuation theorem proved by Evans and his colleagues in 1993 shows us that, at the scale of a proton and neutron, there can become a high probability of significant time reversal of the physical dynamics. This means that the law of attraction and repulsion of charged particles

-such as two H<sup>+</sup> ions in solution — "runs backwards" or is reversed, so that momentarily like charges attract and unlike charges repel. We have called the region in which this reversing of the physics occurs a *time reversal zone* (TRZ). With the recentwork of Evans et al., the existence and occurrence of TRZs even well above the proton (the H<sup>+</sup> ion) level is now clearly established, including the reversing of the physical dynamics. These concepts have not yet been applied to cold fusion interaction results by the leading cold fusion researchers, but they now stand as

explaining the most probable mechanism for the observed phenomena. In this Chapter we have written some of the typical new nuclear reactions that can occur in such a TRZ, and the exact products of these reactions are widely reported in several hundred successful cold fusion experiments.

We shall return to time-charging and time-charge decay when we examine and explain the odd instrumental anomalies experienced for some time in experiments at China Lake.

## 10.4 Time Reversal Zone and New Nuclear Reaction Mechanisms

It follows that the flow of a mass through positive time must involve a preponderance of reactions with photons rather than antiphotons, since *net* absorption and re-emission of photons (rather than antiphotons) is involved. Otherwise, the absorbing and emitting mass would not accomplish little "jumps" forward in positive time.

Suppose we deliberately arrange a situation where the target mass is interacting with a preponderance of antiphotons. In this case, the mass will be time-reversed, as will be the EM energetics.<sup>298</sup> This leads us to the novel concept of a *time reversal zone* just described in footnote.

A time-reversal zone (TRZ) is a region of space, or electrolyte, etc. in which given masses or charges of interest are interacting on the average with more antiphotons than photons. Consequently, in the TRZ the usual EM energetics are reversed and normal charge reactions appear to "run backwards" insofar as the spatial 3-space observer is concerned.

For example, in electrolytes in a region of highly loaded positive charges in a loading palladium lattice with properly prepared surface, a very great number of double surfaces exist. Hence a great number of scalar interferometries continually occur from that large number of double surfaces acting as scalar interferometers {613}. Because of the highly excess positive charge loading, these interferometers are predominately fed by negative EM energy from the positive charges. Hence, in the distant interference areas in the electrolyte outside the palladium lattice, some

<sup>298</sup>This *is not* time-travel in the classical science fiction sense. For time-travel, the traveling object must remain moving in its own forward time, while the entire remainder of the universe must be reversed in its time and must move backward in time to a past coordinate. That is not what is happening here, and no one is suggesting we can time-reverse the rest of the universe! Instead, energy can be reversed in time, as proven in nonlinear phase conjugate optics. So can mass-energy and charge-energy, as shown by the Dirac theory of the electron. An *observed* positron is an electron observed while traveling backwards in time, so to speak, with respect to the observer. But it is observed in observer forward time as traveling in the opposite spatial direction, having positive mass and positive energy, and with the sign of its charge reversed from negative to positive.

negative energy fields and negative energy potentials are produced dominantly. An excess of antiphotons is produced in those interference zones where an excess of antiphotons appear due to the scalar interferometry. In *those* little interference zones, the simple positive ions are momentarily bathed in an excess of antiphoton interactions. This is therefore a time-reversal zone of momentary time-reversed EM energy flow.

From a palladium lattice loaded with  $H^+$  or  $D^+$  ions, and also having a proper surface with many work grooves and thus many small interferometers, random fluctuations in the scalar interferometry occur in the adjacent electrolyte. Some of these random scalar interferometries continually form fleeting *time reversal zones* (TRZs) in their interference zones in the surrounding electrolyte. The very large energy required for the formation of each TRZ and its reversal of the normal laws of attraction and repulsion of charges, is available from conversion of time energy from the time domain as a result of the giant negentropy mechanism in 4-space ongoing in the loaded positive charges (614, 615) in the palladium lattice.

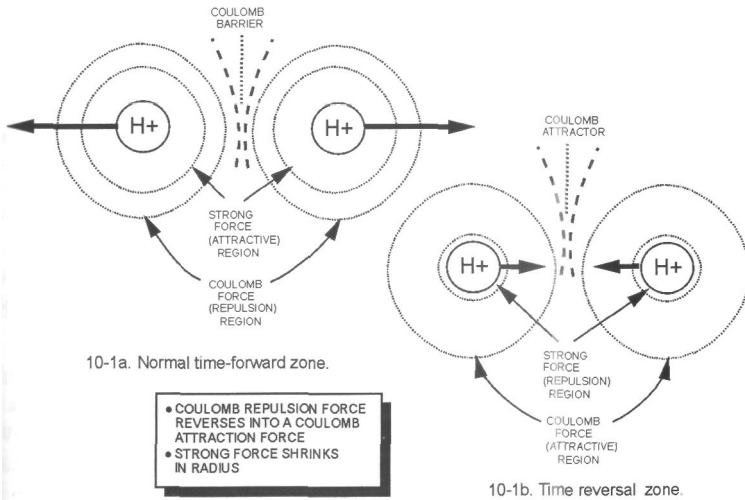

Figure 10-1 Forces on nuclei of simple ions in time-forward and time-reversal zones.

See Figure 10-1. In Figure 10-1a, two hydrogen ions (two free  $H^+$  protons) in a normal electrolyte and in a normal time-forward zone are shown. The

Coulomb barrier dramatically increases the forces of repulsion between the two  $H^+$  ions as their kinetic energy may be driving them momentarily toward each other. This Coulomb barrier becomes so strong that it stops the approach of the two ions and forces them back apart, or to deviate aside from their paths, before each can ever enter the very short-ranged strong force region of the other. Consequently no nuclear reaction occurs, but only a common chemical reaction. The maintenance of that Coulomb barrier is all that prevents energetic ions from being driven together closely enough to engage the strong force and cause the ions to form a new nucleus (cause a transmutation).

Now see Figure 10-1b, for the same two ions that suddenly find themselves in a momentary time-reversal zone (TRZ). In a temporary TRZ, suddenly like charges attract and unlike charges repel, exactly in reverse of the *normal* behavior of charge attraction and repulsion. The usually increasing Coulomb barrier (repulsive force between the two approaching  $H^+$  ions) has disappeared and been replaced by an increasing Coulomb attractor (attraction force). Further, the strong force has been partially reversed and much weakened since the gluon forces are dramatically reduced and fluctuating.<sup>299</sup> The attractive strong force is now a partially *repulsive* force and so it is much weaker. Consequently, the quarks in a proton or neutron are not nearly so strongly bound as they are in a normal time-forward zone (TFZ).

A TRZ represents a highly time-charged excited local state in that local region of the electrolyte. The moment a TRZ is formed, the surrounding ions in the electrolyte outside the TRZ immediately move or deviate their movements to reverse this TRZ action<sup>300</sup> and convert it back to a time-forward zone (TFZ). Hence once it is born in the electrolyte, the TRZ decays rapidly due surrounding ion movement changes, and even more

<sup>299</sup> Again we stress the tremendous energy density of the time-energy involved. These cold fusion interactions are actually higher *total* energy reactions than nuclear physics presently uses, even though the *spatial* energy density of the reactions is very small. Together with the now-proven fluctuation theorem of Evans et al., the TRZs and reversal of the normal Coulomb barrier into a Coulomb attractor open up a vast new nuclear chemistry of direct nuclear transmutation reactions at low spatial energy but at very high tempic energy. The ability to directly engineer the quarks and the gluon forces, e.g., opens up a new chemistry of direct subparticle engineering heretofore considered quite impossible by chemical means.

<sup>300</sup> Their approach increases the fraction of photon reactions relative to antiphoton reactions, since the other ions are moving in a TFZ on the average.

rapidly due to the rapid variation in the fluctuating scalar interferometers in the loaded palladium lattice. In most cases, the random fluctuation in the scalar interferometry is so rapid that the TRZ decays back to a normal TFZ before the two approaching H<sup>+</sup> ions can reach each other (reach each other's reduced strong force repulsion region). However, in a certain percentage of approaches, the two approaching like-charged ions will "reach each other" — i.e., each will enter the weakened strong force region of the other before decay of the TRZ occurs.

See Figure 10-2. In Figure 10-2a, we show the case in which the TRZ lasts long enough for the two H<sup>+</sup> ions to reach each other's strong force repulsion zones and form a quasi-nucleus. Here they vibrate back and forth in a dynamic dance around the zero net force axis between their repulsive strong forces and their attractive Coulomb forces. In this case, a new kind of nuclear reaction is set up to occur. Decay from this excited quasi-nucleus state in a TRZ can occur into a real nucleus in a normal TFZ. Energetically, because the quarks are so loosely bound now<sup>301</sup> the preferred decay mechanism when TRZ → TFZ is by appropriate *quark flipping*.

As a little bit more time passes, the interferometry changes and the TRZ decays, returning back to a normal TFZ. In a change from TRZ to TFZ, the energy change is enormous because time-energy is involved, with energy density equal to mass. The only difference in a proton and a neutron is the orientation of one quark (three quarks make up each of the particles). As TRZ decay starts and progresses, the strong force changes back to a powerful attractive force. It increases its strength far more powerfully and quickly than the Coulomb attractive force reduces its reversal and changes back to a repulsive force. The addition of the extra energy from the now-increasing strong attraction force simply causes one nearly-freed quark in one of the two H<sup>+</sup> ions to flip, converting that H<sup>+</sup> ion into a neutron n.

Instantly the preferred decay product is the deuterium ion D<sup>+</sup>. So the H<sup>+</sup> and the n simply draw a bit closer together, each now fully inside the

<sup>301</sup> To appreciate the sheer raw power of the time-energy control of interactions, simply examine the enormous *spatial* energy density required in high energy physics to try to approach the "free quark" condition. Enormous and very expensive *spatial energy* accelerators are used, at the absolute state of the art. By going to the use of the extraordinarily dense time-energy, quarks can readily be freed or nearly freed in electrolytes, and they are nearly freed in more than 600 relatively simple and inexpensive cold fusion experiments (753) on the bench-top to allow new nuclear reactions by quark flipping, where a proton turns into a neutron or vice versa.

rapidly increasing attractive strong force region of the other. This converts what had been a quasi-nucleus of two  $H^+$  ions into a real  $D^+$  nucleus. This result is shown in Figure 10-2b.

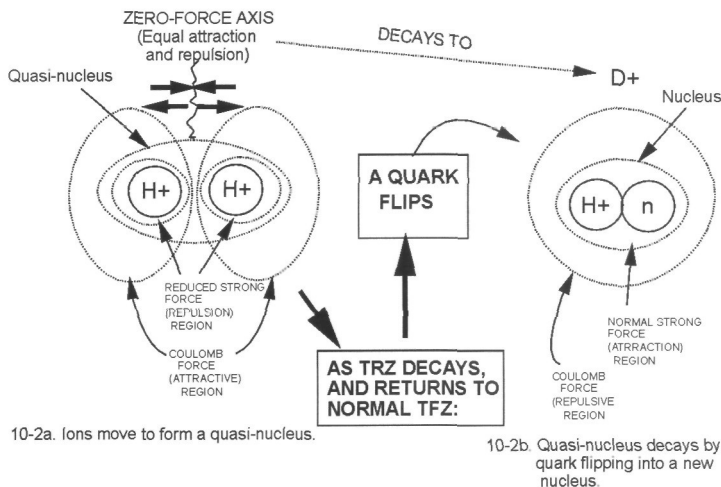

**Figure 10-2. Production of quasi-nucleus and its decay by quark-flipping into a new nucleus as the time-reversal zone decays back to a time-forward zone.**

Recapitulating: As the TRZ subsequently decays back to a normal time-forward zone (TFZ), the new quasi-nucleus becomes an excited state, and decays. However, the quasi-nucleus decays by very novel means. Because of the time reversal, the energy changes induced in the decay *start* at each spacetime point inside the quasi-nucleus, deep inside the quarks, and proceed outward. The first interaction of the decay mechanism is with the quarks comprising the nucleons (in this case, the protons). With the gluon forces still very much weakened, quark flipping becomes the preferred decay mechanism. Hence one quark in one proton flips its orientation (that is the mechanism of decay!) and the nucleus — now a nucleus comprised of a proton and a neutron — becomes a nucleus of deuterium.

As can be appreciated, the clustering of different types of like-charged but relatively simple positive ions in TRZs in solution, with subsequent decay of the TRZ into a TFZ, initiates a revolutionary new family of nuclear reactions at low spatial energy (but very high temporal energy), completely contrary to, and not included in, the present forward-time high-spatial

energy (but very low time-energy) reactions model known in particle physics.

In the future, as these new time-energy-based reactions are extended and mastered, scientists will simply assemble desired nuclides in solutions in the laboratory, at low spatial energy (but high time-energy) and at will. We point out but do not pursue further the fact that these new reactions also open up cheap, practical, electrochemical means of altering nuclear and chemical wastes. We therefore foresee a dramatic development in this area, in order to clean up the presently polluted biosphere of much of the chemical and nuclear waste contaminants.

Indeed, we propose that a very strong program in mastering these new nuclear reactions be launched and supported by the U.S. Department of Energy, so that the nuclear wastes storage problem can be permanently solved, much more cheaply, and without having to store hazardous nuclear wastes for centuries. Instead of merely *talking* about "out-of-the-box thinking and research", the DoE should actually do some of it, over the violent objections of the entrenched conventionalists of the national laboratories. Their own great national laboratories are the major part of the problem, not the solution, for both innovative nuclear reactions and innovative energy systems! The problem is that "in-the-box" entrenched conventionalists do not perform or allow "out-of-the-box" research that strongly threatens their vested interests.

The TRZ decay conversion of two protons into a deuteron — by easily flipping one quark in one proton — is an example of the so-called "nuclear reaction at low energy" that has been so controversial *to* the orthodox scientific community, even in the face of some 600 successful cold fusion experiments. Contrary to the assumption of the conventional physics community and the skeptics, these are not "low *total* energy" physics reactions at all. Instead, they utilize energy density on a level commensurate with that achieved in the largest accelerators available and even much higher. *This is actually a much higher total energy physics than the present conventional high energy physics heretofore known or used.*

Particularly in a deuterium-enriched (deuterated) electrolyte, a variety of simple ion arrangements of D<sup>+</sup> ions and H<sup>+</sup> ions can occur. Many of these combinations and arrangements can and will occur in TRZs if sufficient loading of the palladium lattice is achieved. Below we will present and explain a few of these new nuclear reactions that have occurred in successful cold fusion experiments. First, to be tidy we must correct the



present statement of the conservation of energy law by extending it to include time-energy.

The excess heat usually experienced in the electrolyte is explained by the added negentropy (added energy) from the time-domain, which then dissipates randomly in the solution, producing excess heating. Later we will cite strong experimental evidence for the involvement of such time charging (time-energy charging), with subsequent time-charge (time-excitation) decay as ordinary photons in cold fusion experiments.

## 10.5 Revision of the Conservation of Energy Law

### 10.5.1 Unaccounted Transduction Extends the Conservation of Energy Law

Along with the re-emission of all the previously absorbed spatial energy, all the previously absorbed time-charge of the excited electron may be re-emitted with a longitudinal photon/scalar photon pair (a graviton) when the time-excited state decays. In that case, no energy-charging permanent change results to the electron's original energy state. Hence no "electron wiggle" will be created and our normal "electron wiggle" detectors performing such non-transducing longitudinal EM wave interactions will not exhibit an indication. In short, the "pure" time-charging EM LW interaction is unobservable to present instruments. All they "see" is the "same electron" sitting there and "flowing through time".

However, if two or more such gravitons are simultaneously emitted from various reactions in time-decays, the emitted scalar photons and waves may interfere at some little distance. In that case, transverse EM waves and ordinary EM energy will be produced in the interference zone {613}. To the external observer, these EM fields and forces will simply seem to arise spontaneously and emerge from every point in spacetime inside that interference zone, moving outward from there in conventional "propagation through space" manner. In that case, the normal "photon" (actually, graviton) decay processes plus scalar interferometry have resulted in transducing some time-energy into ordinary spatial EM field energy. Such reaction provides the excess heat demonstrated in successful cold fusion experiments.

This is also a true action at a distance reaction, presently unaccounted in particle physics. Action at a distance is required in quantum mechanics, and it has been experimentally demonstrated multiple times in distant photon correlation experiments. Once any action at a distance is admitted because it has been experimentally proven, there is no logical restriction

that only a single mechanism exists for it. Consequently, many of the present foundations assumptions of physics and some of the things previously abandoned because of their conflict with those assumptions will have to be re-examined {616}.

Scalarinterferometry is indeed a mechanism for action at a distance. While still mostly absent from open physics, it has already been weaponized by some 10 nations of the world. Indeed, U.S. Secretary of Defense William Cohen confirmed in 1997 that (novel) electromagnetic processes are already being used to initiate earthquakes, stimulate volcanoes into eruption, and engineer and control the weather {617}. Whether or not it is present in the particle physics texts, scalar interferometry is being widely used clandestinely in several armies today. It has also been used to shoot down missiles and aircraft as tests. The so-called "Cold War" was not quite as cold as the news media and U.S. scientific community were led to believe.

Because of the ubiquitous involvement of unaccounted time-energy in all photon interactions, an extension to the present form of the conservation of energy law is required. The present (special case) law is

$$E(E)_1 + E(m)_1 = E(E)_2 + E(m)_2 \quad [1]$$

where  $E(E)$ =energy in conventional non-massive energy form,  $E(m)$ =energy in mass form, subscript 1 refers to the measurement at time 1, and subscript 2 refers to the measurement at time 2. This is just the well-known Einstein formulation that the sum of the ordinary energy and the mass-energy is conserved.

However, that law is for a special case. It assumes that there is no transduction of time-energy into either mass-energy or ordinary energy.

I.e., it assumes 3-symmetry and t-symmetry in EM energy flow. Since every charge in the universe already violates both that 3-symmetry and t-symmetry of energy flow, the fundamental assumption in the Einstein formulation is falsified by the general case. The conventional conservation of energy law is a special case where only the two mentioned energy flow symmetries are upheld. When they are violated, then transduction of EM energy between 3-space and time occurs. For that case, the conservation of energy law must be extended to

$$E(E)_1 + E(m)_1 + E(t)_1 = E(E)_2 + E(m)_2 + E(t)_2 \quad [2]$$

The **new** law simply states that the sum of the ordinary spatial energy, the **mass-energy**, and the time-energy is conserved. This extension of the **conservation** of energy law becomes important in successful cold fusion

experiments, where transduction of time-energy into ordinary heat energy occurs and where one encounters very anomalous reactions differing from those reactions known and accepted in conventional nuclear physics.

### 10.5.2 Transduction Between Time-Charging and Spatial Energy-Charging

The oscillating energy (spatial and temporal) in a moving EM wave in the vacuum represents a moving oscillation of spacetime curvature. Simply put, the so-called electromagnetic wave in space is actually a gravitational wave in space, since it is an oscillation of the local energy density of spacetime and therefore an oscillation of the curvature of local spacetime. It "transports" gravitons (scalar photon/longitudinal photon pairs) rather than merely photons. So let us now consider it as a gravitational wave.

In the absorber under special conditions, a small fraction of the graviton wave time-density absorbed will sometimes change (transduce) its time-energy into what we call transverse photon energy effects {618}, with something like a  $10^{17}$  gain in spatial energy in joules compared to the time in seconds that actually transduces. In other words, 1 second of time transducing into EM transverse wave energy (using the standard EM modeling approach) will yield approximately  $10^{17}$  joules of spatial EM energy. Since one can change energy from one form to another, *one can change time-energy into 3-spatial energy and 3-spatial energy into time-energy*, the two being merely opposite sides of the same coin, and both always involved in any situation exhibiting electrodynamic dipolarity.

In one's physics model, the choice of fundamental units is purely arbitrary. Everything can be expressed in a single fundamental unit, as pointed out by Jackson (see quotation from Jackson at the beginning of this chapter).

In a situation where 3-symmetry and t-symmetry in EM energy flow are broken, part of the *time charging* of the atomic electrons (or ions) sometimes changes (transduces) into *spatial energy charging* and vice-versa. This cross-dimensional decay of time-excitation states results in the emission of some extra transverse photons that may be either photons or antiphotons, depending on the exact interactions. The point is, *tremendous excess EM spatial energy can appear and either be emitted as heat or interacted to perform new nuclear interactions as extraordinarily high local energy density*. This is the master mechanism enabling anomalous cold fusion transmutation reactions. The amount of time transduced will be so small that it will usually escape notice, unless stringent efforts are used to measure changes in the local flow of time.

The excess photon energy (excess 3-space EM energy) appearing in these rather random but powerful transduction interactions often accounts for the production of anomalous excess heat - for example, as occurs in many cold fusion experiments. Where scalar interferometry is maximized, a more exact action will be detailed below for the specific nuclear transformations that occur by novel new nuclear reactions. These novel nuclear reactions occur at low *initial* spatial energy but with some time-energy transducing into additional very high spatial energy to initiate the interactions.

### 10.5.3 Resolving the Energy Conservation Problem in Cold Fusion

When transduction is involved, standard "transverse EM waves only" computations will seemingly yield violation of energy conservation — e.g., from the emission of excess heat. That is an erroneous interpretation; energy overall is conserved, but some of the unaccounted *time-energy flow* is transduced into 3-spatial transverse photon energy dissipation. Neither 3-spatial energy nor mass-energy nor time-energy alone, or in any pairing, need be individually conserved; only the combined *total energy of all three energy components* is conserved. This resolves the present major "sticking point" between the cold fusion researchers and the conventional "transverse wave" nuclear and electrodynamic communities regarding energy conservation difficulties and perpetual motion accusations. Those making the accusations and those defending against them are both using only a special-case conservation of energy law, and a more general law is required.

Let  $t$  = time in seconds, and  $W$  = energy in joules. Rounding the speed of light to  $3 \times 10^8$  meters/sec, the energy  $W_{TW}$  emerging as transverse wave EM energy in 3-space by the transduction of time into 3-space energy is approximately

$$\text{One sec} = c^2 \text{ joules} = 9 \times 10^{16} \text{ joules} \quad [3]$$

and

$$t \Rightarrow W_{TW} = 9 \times 10^{16} \times t \text{ (in joules)} \quad [4]$$

Let us present the new energy conservation law in slightly different form. Let  $W_{TW}$  = energy measured in spatial energy form, conveniently taken as transverse wave (TW) EM energy. Let  $W_m$  = energy in mass form (energy compressed by  $c^2$ ). Let  $W_t$  = energy in time form (energy compressed by  $c^2$ ). The present conservation of energy law is

$$W_{TW} + W_m = W_{(\text{total})} \quad [5]$$

The new extended conservation of energy law is

$$W_{TW} + W_m + W_t = W_{(total)} \quad [6]$$

The conventional particle physics accounting will see only

$$W_{TW} + W_m = W_{(total)} \quad [7]$$

The conventional accountant will be unable to see

$$t \Rightarrow W_{TW} \quad [8]$$

so he will observe that the experimenter is reporting that

$$[W_{TW} + W_m]_1 \neq [W_{TW} + W_m]_2 \quad [9]$$

which in his lexicon is a violation of the conservation of energy law itself. In short, he will identify it as a typical example of a claimed perpetual motion machine or interaction. Then the defender of the faith will wax eloquent, applying labels such as "perpetual motion nonsense", "voodoo science," etc. He himself is practicing a hoary old "voodoo" science and ignoring newer science. None of these defenders of the faith even know what powers an electromagnetic circuit or how it is that every little charge in the universe is able to continuously pour out observable EM energy in all directions, with no observable EM energy input.

On the other hand, a reasoned response will be given by real scientists still following scientific method, when faced with the numerous replicated successful experiments. The scientific method insists on the absolute priority of the replicable experiment over the predictions *of any* theory. Consequently, such reasonable scientists will advise that the protagonists cease their vitriolic rhetoric and let real science take its course; i.e., let further experiments confirm or refute reported successful results of cold fusion experiments.<sup>302</sup>

<sup>302</sup> Precisely such a reasoned response by chief editor Donald Kennedy of the journal *Science* has recently been given, providing a breath of fresh scientific air into an attempt by "defenders of the conventional faith" to destroy publication of important experimental results in sonoluminescence. The article which courageous editor Kennedy approved for publication — over intense objections of the professional critics — is R. P. Taleyarkhan et al., "Evidence for Nuclear Emissions During Acoustic Cavitation," *Science*, Vol. 295, Mar. 8, 2002, p. 1868-1873. We heartily commend Editor Kennedy for this classic example of how science should be conducted — so that experiments, not prevailing dogma, determine what is valid and what is invalid.

What the professional skeptic will not see is that his own expression of the conservation of energy law has been incomplete, and that it is his own inadequate "measurement yardstick" assumption that is now in error. The *extended* conservation of energy law of course still holds, but the *conventional* special case law is violated because its fundamental assumption — that time is not transduced to spatial energy in the experiments — has been violated in the experiment.

Indeed, with the publication of the work of Evans et al., experimentally proving the fluctuation theorem and the high probability of time reversal zones appearing for short but significant periods at up to micron levels, the second law of thermodynamics has been rigorously proven to be violated. Hence the conventional scientific community's rather dogmatic objection to the extra heat of cold fusion interactions is no longer scientifically justifiable.

Understanding of the extended conservation of energy law and the permissible violation of the second law of thermodynamics resolves the present thorny dissension within the scientific community over the excess spatial energy produced by cold fusion. It also resolves the issue of what could possibly be a source of such intense energy density as is required for nuclear transmutation reactions.

Any ordinary system is indeed an open system, freely and continuously exchanging energy with its *temporal* environment as well as the seething active vacuum.<sup>303</sup> If the system is in temporal energy equilibrium in that exchange, then the present restricted conservation of "spatial and mass" energy law applies and one does not have to consider the interactions between supersystem components. If the system is placed in disequilibrium with its temporal energy environment, then supersystem components interact asymmetrically and the extended conservation of energy law applies. In that case, excess spatial energy can be and will appear in the system whenever time transduction into spatial energy is occurring.

<sup>303</sup> But see our Appendix A. Present thermodynamics rather inately defines a "closed" system as one where no mass exchange crosses its boundary with its environment, but energy exchange can and does. In that view, a "closed" system can be far from equilibrium in its energy exchange with its active environment, and thus demonstrate the five magic attributes of such disequilibrium systems. In this book we have deliberately chosen to treat a "closed" system as one in which neither energy nor mass exchange crosses the system boundary — which classical thermodynamics refers to as an "isolated" system. We explain all this (and why) in Appendix A.

The implications of cold fusion energy transduction are that

- (1) Time is being "burned" or transduced as a "fuel" and source of energy,
- (2) Transduction of only one microsecond per second will yield  $9 \times 10^{10}$  watts steadily. That's 90,000 megawatts of energy per second — the equivalent of 90 large 1,000-megawatt power plants — if all the transduced energy were collected and used to power loads with 100% efficiency.
- (3) Thousands of new nuclear reactions are made possible and feasible by local transduction of time-energy into 3-spatial EM energy.
- (4) Appropriate capture and use of a portion of the excess energy can be accomplished to power loads.

Even if we capture and utilize only 1% of the transduced time-energy to power the loads, where the *time-energy to spatial energy transduction* is only the transduction of 1 microsec/sec, that system will produce the normal EM energy to power 900 megawatts in the load. That's almost 90% of the capability of a modern 1,000-megawatt power plant. That is quite a respectable electrical power system. It only requires the transduction and "burning" of one microsecond of time per second, without any nuclear wastes or hydrocarbon byproducts.

As can be seen, transducing time into energy is by far the most efficient way to go to develop new power plants for the future. This is particularly true since every charge in the universe already transduces time-energy flow into spatial EM energy flow. Indeed, we may consider that the negative charge transduces time-energy flow into the spatial outflow of EM positive energy, while the positive charge transduces negative time-energy flow into an outflow of EM negative energy. The process is useful not only for power applications, but also for transport applications as we briefly pointed out in Chapter 8.

## 10.6 Some Resulting *Low Spatial Energy* Nuclear Reactions

Refer again to paragraph 10.4 above. Summarizing: The formation of time-reversal zones (TRZs) is what enables the appearance of the new nuclear reactions in the electrolyte in cold fusion experiments. It does this by changing the Coulomb barrier between like charged ions into a Coulomb attractor. Further, the rate at which TRZs form and decay in the solution is a function of the frequency and intensity of the scalar interferometry from

the loaded palladium lattice. This means that the appearance of the new nuclear interactions in the electrolyte is also a function of the degree of loading of the palladium lattice, as well as the "double surface" interferometry preparation of the palladium, its cracks, etc. These are the major variables. Once the major variables provide the solution for significant formation of TRZs, then the following reactions can and do appear.

The sample reactions we present here are just a few of the thousands of new reactions possible. These example reaction products have been found in a great many successful cold fusion experiments in various laboratories around the world. Some 600+ successful experiments have now been done, and a sizable literature has built up and continues to be built up on the experiments and their results.

For our sample reactions, the primary mechanism of interest consists of several parts:

- (i) Formation of a TRZ, in which two positive ions (we shall look at  $H^+$  and  $D^+$ ), now attract each other. Also, the gluon forces in the proton and neutron, in the ions of interest, are significantly lessened, so that the quarks in each proton and neutron are very much more loosely bound. Consequently, decay from an excited state by quark flipping to turn a proton into a neutron or vice versa becomes an attractive option. The strong force is therefore reduced in radius.
- (ii) Two positive ions now attract each other so closely that each enters the edge of the weakened strong force region of the other. This forms a *quasi-nucleus* because of the limited involvement of the weakened strong force.
- (iii) The other ions in solution surrounding the TRZ immediately move (as soon as the TRZ is formed) to negate the TRZ and decay it back to a time-forward zone (TFZ). This action initiates the decay of the TRZ.
- (iv) As the TRZ lessens and then turns back into a TFZ, the strong force expands its size faster than the novel Coulomb "like attracting like" force reduces and reverses.



- (v) The rapidly expanding strong force of each of the two ions in the quasi-nucleus fully envelops the other ion, increasing the disequilibrium of the two-ion quasi-nucleus. A condition is reached where the most probable mode of decay is the flipping of one quark in one of the positive nuclei.
- (vi) The quark flips, turning that H<sup>+</sup> ion into a neutron n. This is a quasi-nucleus of deuterium (D<sup>+</sup>), still in an excited state but with less excess potential energy in the excited state. At this point, the TRZ is vanishing and the TFZ state is returning.
- (vii) As the TRZ vanishes and TFZ state increases back to normal, the most probable mode of decay increasingly is to a full deuterium nucleus. Hence the H<sup>+</sup> and n simply draw completely into normal deuterium binding position, bound by the normal strong force. This constitutes a normal D<sup>+</sup> ion, now existing in a normal TFZ.
- (viii) So by formation and decay of a significant TRZ, two H<sup>+</sup> ions have been drawn together into a quasi-nucleus consisting of two H<sup>+</sup> ions partially bound by a weakened strong force. As the TRZ decays and the Coulomb repulsion resumes, the strong force increases back to full strength faster than the Coulomb repulsion force returns and repels the two H<sup>+</sup> ions. Since the quarks are much more loosely bound than normal, a quark in one of the H<sup>+</sup> ions has flipped, turning the ion into a neutron n. The H<sup>+</sup> ion and the neutron, partially bound already in a quasi-nucleus, simply "tighten" into a normal D<sup>+</sup> nucleus as the TFZ condition is fully resumed.

The nuclear reaction equation for the above interaction may be written as

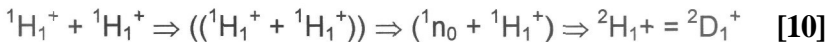

In equation [10] we use the left superscript as the number of nucleons in the ion nucleus, the right subscript as the protons in the ion nucleus, and the right + superscript to show the overall charge of the ion and its sign. We use the expression in parentheses to show the involvement of a time-reversal zone (TRZ). Double parentheses show a stronger TRZ than single

parentheses. Thus from double parentheses to single parentheses to no parentheses shows the initial formation and subsequent decay of the TRZ.

Another interaction involves a D+ ion and an H+ ion, to produce tritium. This is:



That reaction transmutes a deuterium ion and hydrogen ion into a tritium ion. Without showing it, in a TRZ three  ${}^2\text{H}_1^+$  ions may also attract into a quasi-nucleus, and as the decay of the TRZ occurs, first one proton turns into a neutron and then a second one does also, by quark flipping. This nuclear reaction also produces a fusion into tritium.

Another reaction between two deuterium ions is"



That interaction — particularly in pre-deuterated electrolyte solution — gives the excess a particles produced in a great number of the cold fusion experiments.

A rarer but still occurring interaction is:

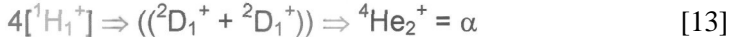

Indeed, reaction [13] may occur to completion and formation of a particles in some of the transmutions in an electrolyte, while it proceeds only to the intermediate phase in others. In that case, both deuterium ions and a particles may be produced out of the same overall "chain of reactions" where some reactions proceed all the way and some do not.

These interactions are directly using and transducing time-energy by use of the TRZ to time-reverse the Coulomb repulsion law for like charges. From the reactions, excess energy given off as heat may and will occur.

The nuclear physicist and nuclear chemist can immediately see a great many new nuclear reactions now made possible by the adroit production and decay of TRZs. A great number of these new nuclear reactions are now possible by this means, which are impossible in ordinary nuclear chemistry without the deliberate formation of TRZs.

These few examples serve to illustrate the process, and these reactions represent res alts already achieved in numerous cold fusion experiments worldwide, by many researchers and multiple laboratories. Now we turn to other evidence strongly supporting the novel nature of these reactions

rather than several other proposed reaction equations yet to be proven. The other proposals do not explain the next type of new experimental reaction.

## 10.7 Time-Energy Can Generate Instrumentation Anomalies

Strong evidence for time-charging and time-charge decay is experimentally demonstrated in electrolyte experiments where time-reversal zones (TRZs) are operating, and thus where some localized processes are running backwards in violation of the second law of thermodynamics. Weak time-charging of photon-absorbing and emitting matter, with special patterns of spacetime curvatures (engines) induced by time-density oscillations and structuring, is persistent in matter, having "charge-up" and "decay" times that may last for minutes, months, or even years. A very wide range of previously anomalous phenomena, both in inert and living matter, is explainable by these new interactions. This is very probably also related to the "memory phenomena" noted by Kondepudi and Prigogine<sup>304</sup> as outside the present thermodynamics, but being worked on at the forefront in what is called "extended thermodynamics". Quoting Kondepudi and Prigogine, p. 460:

*"...interesting memory effects ...appear for long times (as compared to characteristic relaxation times). ...nonequilibrium processes may have 'long-time tails'. In other words, the approach to equilibrium is not exponential, as was generally believed, but polynomial ...which is much slower. ... As a result, Nature has a much longer memory of irreversible processes than it was thought before. Again this shows that local equilibrium is an approximation, albeit a very good one. "*

In this book, we focus primarily upon some typical anomalous measurements in China Lake experiments that are directly involved with time-charging and decay effects, lending strong support to our thesis of the novel TRZ-induced nuclear reaction chains. Note that these instrumental anomalies are also strong evidence for the association of time-charging and time-charge decay with the proven fluctuation theorem of Evans et al.

<sup>304</sup> Dilip Kondepudi and Ilya Prigogine, *Modern Thermodynamics: From Heat Engines to Dissipative Structures*, Wiley, Chichester, 1998, p. 459. For a discussion of extended thermodynamics, see D. Jou, *Extended Irreversible Thermodynamics*, Springer-Verlag, New York, 1996.

at the Australian National University. We believe this to be a contribution to that very important work of Evans and his colleagues.

### **10.7.1 Ionization Detectors, Transduction, and EM LW Interferometry**

Ionization processes obviously are processes where the partial transduction of LW time interaction into 3-spatial energy interaction would yield ordinary excited energy states of the affected electrons or ions. In turn, this would lead to ionization (e.g., of the atoms and molecules of a gas, liquid, etc.) Hence, ordinary ionization detectors such as Geiger Müller tubes have the innate *capability* of detecting such transduction that generates ionization, and thereby have some capability of serving as "detectors" of longitudinal EM wave interactions (and time-charging) ongoing in the detector. In the usual situation, no excess time-charging results and no time reversal zones result. In that case, symmetry of energy flow in the time-domain exists, as does symmetry of energy flow in 3-space. Absolutely normal chemistry and nuclear chemistry results, and the nuclear detectors function normally, as familiar to every laboratory.

However, when significant TRZs emerge and persist for short periods, the symmetry of both time-energy flow and 3-spatial energy flow is broken. In this case, transduction of time-energy into 3-spatial energy (and vice versa) can result in anomalous ionization in nuclear ionization detectors, even in the absence of normal transverse EM nuclear radiation. The trick is to use and compare different detectors and different types of detectors to clearly demonstrate anomalous ionization detection effects.

As an example, a Geiger Muller tube will detect any ionization of its internal gas, regardless of what caused that ionization. If the ionization is caused by normal ionizing radiation from nuclear reactions, the instrument will detect and read a resulting internal ionization of the gas inside the tube.

On the other hand, if time-charging and decay are involved, then the asymmetry resulting in 3-spatial energy excitation of the gas inside the Geiger Muller tube (due to transduction of some time-energy into excess 3-spatial energy) may be sufficient to ionize the gas. In that case, the instrument will read "as if nuclear radiation were present. Note that there is indeed "ionizing radiation" present in the gas. However, now this ionizing radiation is not transverse EM wave in nature, but is due to the time charging and decay, and transduction of time into 3-spatial energy in the detecting gas.

This capability of an ionization detector to ionize in the presence of non-transverse wave ionizing radiation and energy can be used to provide an indication of time-density waves being formed and interacting in a process (such as a cold fusion process) where some transduction from time-energy to 3-spatial energy occurs.

Further, the previous "time history" of the individual instrument plays a part in whether the instrument "reads" or not for a given transduction situation. There will be a statistical variation of the actual "already present" low-level time-charge (and in its internal structure and engines) between instruments, even those made in the same factory on the same day from the same batch of materials and parts. That is because the time-charge and discharging history of each instrument has been different.

The production of transduced TWs, however, must be a function of scalar interferometry in the gases or other detecting media of the instrument, since scalar interferometry *creates* all transverse EM waves, as shown by Whittaker {619} and confirmed by Evans *et al.* {620}. In such interferometry, the entire inner structures of the transverse EM waves formed in the interference zone also interact wave-to-wave. Thus, this kind of interferometry is extremely sensitive to the exact internal longitudinal EM bidirectional wave structure (internal engine substructure) of the involved potentials.

As a consequence, the ability of an ionization detector to transduce a specific set of LWs and give ionization detection will vary appreciably, including for different variations in the instrument's original manufacturing process, and even for the specific past photon interaction history and experience of the individual detector itself. One detector's set of cumulated internal time-charges (and hence spacetime engines) may vary considerably from those of a second detector of exactly the same type. In general, multiple ionization detectors are unlikely to all detect a given time-density EM wave emission and interaction set {621}.

Even for two detectors of the same brand, from the same manufacturing plant, and from the same batch of manufacture, it is likely that significant differences in LW detection of a specific TDW set will occur because of the "past history" time-charge differences of the individual detectors. Indeed, a likely phenomenon is that, when one ionization detector detects the LW emissions (transduces them), several others will not detect them at all. This is one of the peculiarities of the new unified field area that must be overcome by further research in order to develop reliable, calibrated TDW and transduction detectors. It is one of the primary problems - if not

*the* primary problem - of cold fusion research to resolve this "*time-charge experience history*" problem, so that transduction detectors having calibrated, uniform responses to given TDW sets and interactions can be provided.

At present, no one has the foggiest notion as to how to "calibrate" a nuclear ionization detector that one desires to use as a time-energy transduction detector. Speculating, we would envision such calibration (in the transduction detecting functional response) to become possible when small, standard, calibrated sources of transduction are developed and available. In that case it will be possible to formulate procedures whereby varying the output of the transduction source will vary the transduction irradiation of the GM tube. The level of transduction intensity required to create ionization in the instrument will be a direct indicator. When small, calibrated sources of TDWs are also available, it will be possible to irradiate the GM tube to a specifically desired rate and level of time-charge and decay. In that case, an array of GM tubes can be "standardized" or "calibrated" for transduction detection. So far as this author is aware, those developments have yet to be accomplished or even undertaken. Indeed, the need for such a development program has not even been realized.

### **10.7.2 Experimental "Detector Transduction Phenomena" in Electrolysis**

**Let** us look at one set of ongoing scientific experiments where just such anomalous detector results have been obtained.

Researchers at the Naval Air Warfare Center at China Lake, and at the Department of Chemistry, University of Texas at Austin, have detected precisely the kind of "anomalous" radiation and transduction effects we expect to be in the ionization processes of multiple kinds of detectors {622}.

According to a report by Miles and Bush {623}, anomalous radiation at China Lake was first detected by the exposure of dental X-ray films in two experiments producing excess power (excess TW energy emission). Film used in a control study during these experiments showed no exposure. There was also no exposure of similar films in more than 20 experiments where no excess power was present. In other words, the presence of excess heat (excess TW energy emission) strongly indicates the presence of transduction. In turn, the presence of transduction implies the presence of scalar interferometry wave interaction, where TDW waves and LW waves **are** absorbed and **a** mix of LW and transduced TW waves are emitted consisting of gravitons (paired scalar and longitudinal photons). This only

occurs when significant time-charge excitation has built up. Taken in reverse, the presence of LW wave absorption and emission — with transduction into detected excess ionization energy — directly indicates the emission of "anomalous" TDW or graviton radiation, as detected by the resulting TW exposure of the x-ray film. So the "anomalous" radiation detections are consistent both forward and backward.

The film in manufacture is quite strongly quality-controlled. Also, it is used (interacts and indicates) only once. Its past time-charge history has minimal variations between two samples of the film, because there is no repetitious past *detection interaction* history. Hence one would expect a high degree of uniform film detection interaction responses from film to film, to the same graviton emission set. That is precisely what occurs.

We conclude that the behavior of the film in the combined China Lake experiments clearly shows the time charging, graviton emission and interaction, and transduction nature of what is happening when it is known that no normal nuclear radiation is present.

Geiger-Muller (GM) detectors and sodium iodide (NaI) detectors were also utilized when electrolysis experiments using heavy water were ongoing. We again accent that a Geiger-Muller tube does not detect nuclear radiation per se; instead, it detects *anything* that will cause its internal gas to ionize sufficiently. Sufficient transduction in graviton absorption-emission interactions in a Geiger-Muller tube will cause the counter to indicate, because it ionizes the gas and produces an ionization discharge. However, both the specific transduction and scalar interferometry aspects of the ongoing experiment are involved, as well as the previous background time-charge history of the Geiger-Muller tube counter.

Several Geiger-Muller detectors gave anomalously high readings, reaching some 73 sigmas above normal background counts. Most experiments (i.e., most GM detectors), however, gave normal radiation counts, and no anomalous count rates were ever observed when the experiments were turned off. So these anomalous results are differentiated by using multiple, carefully calibrated Geiger-Muller tube detectors. Our interpretation here is that

- (i) There was a variation in the presence of transduction and scalar interferometry from experiment to experiment,
- (ii) The majority of the experiments did not produce significant time-charge and sufficient transduction or scalar interferometry to cause

- detection (ionization discharge) on most (typical) Geiger-Muller tubes, and
- (iii) The transduction effects in the ongoing experimental process were mostly of the rapid variety, and not due to long-term "charge-up" effects conditioning the time-charge aspects and structuring of the experimental apparatuses.
  - (iv) By using multiple detectors, the probability of one or more of the instruments having increased time-charge from specific time-charge histories was increased.
  - (v) With sufficient experiments and sufficient detectors, there resulted a high probability of having at least one or more detectors capable of detecting the levels of graviton radiation and transduction expected from the experiments.
  - (vi) A direct correlation would be predicted — and was observed — in the appearance of the anomalous radiation effects and the expected time periods required to load the palladium with deuterium. As reported by Miles and Bush, *ibid.*:

*"... the anomalous radiation would appear within a few hours in the co-deposition experiments where the palladium is loaded with deuterium as it deposits from solution. In contrast the appearance of anomalous radiation required days of electrolysis for the palladium rods that load much slower."*

We previously discussed the major variables indicated from many cold fusion experiments to include the strong correlation with the degree of loading of the palladium lattice. Hence the effect pointed out by Miles and Bush would indeed be predicted by the present approach and proposed mechanism.

Our interpretation is that the experiments show the time-charge rate effect to be expected in such graviton radiation and transduction interaction phenomena using collection of ions (in this case deuterium) that are much heavier than electrons. The faster the deuterium loaded, the greater the buildup of the interaction of the deuterium in phase conjugating and self-targeting iterative interactions — and therefore the greater the increase in scalar interferometry interactions — inside the palladium lattice. The rate of graviton radiation production and transduction production increases as some function (not necessarily linear!) of the rate of loading of the **deuterium**. As the rate of graviton and transduction production increases,



so does the expectation of anomalous ionization effects in the nuclear radiation detectors. And so does the rate of production of TRZs and the appearance of the new nuclear cold fusion reactions at low spatial energy but very high time-energy.

### 10.7.3 Experiment Confirms It

A clinching observation is given by Miles and Bush, *ibid.*, as follows:

*"One GM-detector would measure anomalous radiation while another GM-detector would be "blind" to any anomalous effect. A few experiments, nevertheless, gave simultaneous anomalous effects from two different radiation detectors."*

Here our comment is that this precisely fits our expectations for demonstrating involvement of

- (i) Time-charging and decay interactions,
- (ii) Consistency with transduction expectations,
- (iii) Consistency with the fact that two different radiation detectors may or may not exhibit or detect the anomalous ionization effects, depending upon the individual past time-charge histories of the two detectors, and
- (iv) Predictable variations in the individual experiments (based on palladium lattice loading time, specific geometry, ionization state of the chemical solution, internal time-charge state and decay rate, and structuring of the apparatuses and their parts, etc.) when transduction-associated phenomena are considered.

The anomalous non-nuclear, non-transverse wave — but ionizing — EM radiation detected at China Lake, and the resulting peculiarities in the measurement apparatus functioning, do strongly support the present proposed approach, the proposed graviton radiation phenomena, and the time-charging and decay and transduction mechanisms presented. It is decisive that sometimes two detectors both indicated, and sometimes one indicated and the other would not. Sufficient replications have ruled out any defect in a single given instrument as the cause of the anomalous detections. That immediately eliminates from consideration all purely transverse EM wave phenomena, conditional only upon the premise that the instruments were properly functioning and calibrated, and that sufficient replications were made for decisive statistics. Those conditions

were all met in the numerous experiments producing these results over a long time and in many repetitions.

As a final thought on the subject, we pose the possibility that the longitudinal EM waves involved may be the B(3) longitudinal field waves advanced convincingly by Evans {624a-624c}. We would recommend the attention of leading theorists and experimentalists to this possibility, as a matter that should be investigated both theoretically and experimentally.

## 10.8 Additional Implications for the Future

### 10.8.1 Longitudinal EM Waves and Undistorted Progressive Waves

There is a revolution in electrodynamics presently underway, due to the unique characteristics of *longitudinal* EM waves<sup>305</sup> and *pseudo-longitudinal* EM waves. A summary by Rodrigues and Lu {625} is particularly revealing.

A pure longitudinal EM wave has infinite energy and infinite velocity — i.e., it appears everywhere at once. "Propagation through space" does not apply; instead, one has stumbled into that weird region where spacetime is multiply connected. In the real world, one meets imperfect longitudinal waves — or *pseudo-longitudinal* EM waves — that still retain a transverse energy density variation residue. These waves are called *undistorted progressive waves* (UPWs).

Such UPWs can move in space faster than the speed of light. This should not be too surprising, since superluminal velocity of intelligent signals has been positively demonstrated by several researchers in quantum-tunneling experiments. As an example, Nimitz {626} and his colleagues have beamed Mozart's 40th Symphony through a barrier in a waveguide at a speed of  $4.7c$ . So the old notion that information cannot be transported at superluminal velocities is *passé*. The Fogal semiconductor has been used in experimental transmitter-receiver pairs to demonstrate superluminal transmission, such as TV pictures and programs. Direct signal transmission from earth to satellite back to earth and through many en route amplifiers and processors has been demonstrated by Fogal to occur far beyond the speed of light. Again, theoretical summary papers by Rodrigues *et al.* {627a-627f} are revealing.

<sup>305</sup> We have pointed out a direct way to generate longitudinal EM waves, by simply oscillating the magnitude of the **Lorentz self-regauging** of a system.

### 10.8.2 Death Knell of the Speed of Light Limitation

Another giant shock has emerged in astrophysics during the last few years, and it is now threatening a dramatic revision to physics. Heretofore, it has been fashionable to assume that gravity itself propagates at light speed. A great deal of very comfortable physics theory has been built around that assumption.

Well, the assumption is not true. Experiments in astrophysics continue to refute it. It now is almost certain that the speed of gravity is at least  $2 \times 10^{10} c$ . A beautiful though somewhat controversial paper by Tom Van Flandern {628} summarized the entire situation. He articulates the comfortable general relativity view held to date {629} as follows:

*"...GR proposes that such changes appear to act instantaneously in the 'near field', but eventually show their true, light-speed-delayed character in the 'far field', which is conveniently beyond our present ability to observe. The necessity of this dual behavior is to prevent the logical need for changes to continue to appear to act instantaneously at ever increasing distances, even to infinity."*

In fact, Van Flandern {630} points out that general relativity already admits superluminal effects in the near field region. He also pointed out the startling nature of the experimental results to relativists, and points out that an attachment to a paradigm has been involved:

*"To many, this result [astronomy's verification that gravity's speed  $v_g \geq 2 \times 10^{10} c$ ] is so contrary to 'common sense' in the light of relativity theory as to be absurd. But Thomas Kuhn has cautioned all scientists to avoid the trap of becoming so steeped in a prevailing paradigm that it starts to seem like common sense and makes other ideas sound and feel wrong. Eventually, even one's professional status can become linked to a prevailing paradigm."*

As Van Flandern further emphasizes, it is not difficult to show by computer calculations of astrophysical situations that any strong limit on the speed of light destroys conservation laws:

*"...anyone with a computer and orbit computation or numerical integration software can verify the consequences of introducing a delay into gravitational interactions. The effect on computed orbits is usually*

*disastrous because conservation of angular momentum is destroyed."*

So here we have a new paradigm in the making. This is a startling change to standard relativity. Either we have to give up the conservation of angular momentum, or we have to accept superluminal speed of gravity in the far field. Years of struggle to detect quadrupole gravitational wave radiation have failed; no direct detection has ever been made. Indeed, the rather arbitrary nature of the entire quadrupole radiation assumption is not required by general relativity, as long pointed out by leading Russian scientists. For example, Vlasov and Denisov {631} *et al.* bluntly state it in these words:

*"...Einstein's well-known quadrupole formula, which is usually employed in general relativity for calculations, is not a consequence of general relativity and is not contained in it. "*

Therefore, it may not really be so surprising that physicists have not been able to detect such quadrupole radiation in a great many laboratory experiments. It is not in general relativity at all.

Of course, our thesis developed in this book is that what we have long called "EM radiation" is in fact gravitational radiation, always involving paired scalar and longitudinal photons and hence time-density waves and longitudinal EM waves. We have pointed out that prior to observation there is no such thing as a separate photon, but there is such a thing as two correlated photons, one time-polarized and the other longitudinally polarized. We believe that there is sufficient meat in our proposed explanation of the anomalous cold fusion results and the anomalous instrument results at China Lake to warrant serious and strenuous investigation of these hypotheses and proposed mechanisms.

Another oddity - usually never stated by Western physicists - has long been known but ignored. When Einstein characterized the gravitational field as a pseudotensorial field, and not a field in the sense of the Faraday-Maxwell field, the consequences were that the 3-space energy laws of the familiar kind really do not exist in general relativity. Shortly after Einstein published his theory of general relativity, this absence of familiar energy conservation was pointed out by Hilbert {632} in these words:

*"I assert... that for the general theory of relativity, i.e., in the case of general invariance of the Hamiltonian function, energy equations... corresponding to the energy*

*equations in orthogonally invariant theories do not exist at all. I could even take this circumstance as the characteristic feature of the general theory of relativity. "*

With our publication of the giant negentropy of 4-space once arbitrary 3-space symmetry and time-symmetry in EM energy flow is removed, one of the truths involved in Hilbert's remark was finally recognized. In addition, what Sen called "the most difficult problem in classical and quantum electrodynamics" {633} has been explained by giant negentropy {12}. Also, it is consistent with an appropriate reinterpretation of Whittaker's 1903 decomposition of the scalar potential {600, 615}. Finally, it is consistent with quantum field theory {634}.

Hilbert was evidently not understood by his contemporaries, since neither Einstein himself nor other physicists recognized the fact that, in general relativity, conservation laws for 3-space energy, momentum, and angular momentum — in the sense we are accustomed to in the rest of physics — in principle may be impossible. That is because one can readily remove 3-space energy symmetry when curved spacetime is permitted. Again, Russian scientists such as Logunov and Loskutov {635} have long pointed out the "unthinkable" and "astounding" fact that the predictions of general relativity are not unique.

In the West until recently relativists were conservative, and this resulted in the sidelining of innovative Western physicists who challenged the prevailing interpretation or extended it. With the experimental falsification of one of the fundamental tenets — that gravity moves at speed  $c$  in the far field — of the prevailing interpretation of general relativity, it appears that we may be approaching an asymptotic burst of great new theoretical work and a dramatic new reinterpretation. If it ever gets into production, we believe that the Fogal semiconductor will usher in that great change of communication speed paradigms that now appears imminent.

Nonetheless, general relativity — whatever the modifications and extensions now called for — will remain a very useful tool indeed. There is simply nothing else on the horizon that can replace it, string theory notwithstanding. The reinterpretation is likely to shed additional light on many present problems such as the nature of spacetime itself, the nature of dark matter, and new insight and progress on unifying physics.

In the new openness that should result, we hope that a great extension and reinterpretation of electrodynamics will also be undertaken, and that it will reveal the underlying powerful structured general relativity infolded inside conventional EM potentials, fields, and waves, as originally revealed by

Whittaker {636}. It may even be that one of the novel concepts {637} we have proposed in this book will yet see the light of day in practical systems.

If so, then hopefully much of what we are addressing in this book will be incorporated in the emerging new physics of the twenty-first century.

# Chapter 11

## Final Perspective: Permissible COP>1.0 Maxwellian Systems

*"Are you certain of that?"* [Augustine, in his famous confrontation with the Skeptics, who held that nothing can be known with certainty.]

*"[It is usually]...assumed that the magnitude of potential energy is irrelevant, being arbitrary to the extent of an additive constant. "* [Block and Crater]. {638}

*"The potentials  $V$  and  $A$ , defined ... in terms of the fields  $E$  and  $B$ , are considered to be nonobservable in Maxwellian electromagnetism, since the energy density associated with them is zero..."* [Lakes]. {639}

*"[The total energy of the atom] depends on the bare mass and bare charge of the electron, the mass and charge that appear in the equations of the theory before we start worrying about photon emissions and reabsorptions. But free electrons as well as electrons in atoms are always emitting and reabsorbing photons that affect the electron's mass and electric charge, and so the bare mass and charge are not the same as the measured electron mass and charge that are listed in tables of elementary particles. In fact, in order to account for the observed values (which of course are finite) of the mass and charge of the electron, the bare mass and charge must themselves be infinite. The total energy of the atom is thus the sum of two terms, both infinite: the bare energy that is infinite because it depends on the infinite bare mass and charge, and the energy shift... that is infinite because it receives contributions from virtual photons of unlimited energy. "* [Weinberg]. {640}

## 11.1 Introduction

The central message in this book is that all EM devices are already powered — though in an inappropriate fashion — by EM energy freely extracted from the seething vacuum. It is also intended to be a clarion call that we must rapidly develop the *appropriate* vacuum-energy powering of our EM circuits and electrical power systems, or else the survival of the nation and of the biosphere is at stake rather immediately.

For this summary chapter, we wish to place that specific area — EM energy from the vacuum — in sharp focus, with the major facets together in one place.

Consequently, for this closing chapter we have chosen and slightly adapted a previous technical rebuttal to the objections of "perpetual motion", "violation of the second law of thermodynamics," "impossible", etc. that we wrote in 2001 in the referee process, to the referees of one of the AIAS papers submitted to a major physics journal. The rebuttal was successful, and it was accepted and upheld by the referees. The paper was then published by the journal, after very vigorous refereeing.

That is as it should be.

Scientific journals provide a proper forum for the free expression and debate of scientific ideas and work. They do not and should not ensure that every paper conforms to commonly held concepts or to the most widely accepted model. As we stated, Chief Editor Kennedy of the journal *Science* has only recently had to restate and accent the principle that science is free from "truth by prevailing authority," and bound by "truth by replicable experiment". Insuring that every paper meets the accepted models and notions would be enforcement of religious belief, not experimental science. Ideas which are wrong will be refuted experimentally; experiment is still the basis of scientific method. In our rebuttal, the argument of the conventional skeptics is thoroughly refuted by experiments already well known in the literature, as we detail.

So we thought it appropriate to close the book with this strong statement of its primary objective: economical, clean, copious electrical energy from the vacuum.



## 11.2 Source Charges, Curved Spacetime, Efficiency, and COP

### 11.2.1 The Source Charge Problem

The received interpretation of the Maxwell-Heaviside theory treats the source charge and source dipole as perpetual motion machines, freely and continuously pouring out EM energy in 3-space in all directions with no energy input. Experimentally one verifies that there is no *3-space observable energy input* to the charge or dipole. In accepting that model, a scientist objecting to  $COP > 1.0$  EM systems has unwittingly hoisted himself upon his own perpetual motion machine petard, by already accepting every source charge and dipole as precisely that to which he is objecting. To explain the source charge, either one holds to the U(1) Maxwell-Heaviside theory and surrenders the conservation of energy law, or one accepts a change to U(1) electrodynamics to add the concomitant input of energy flow from the active vacuum (from the *time* domain, which in Minkowski geometry is all that is left outside 3-space) to that charge or dipole. That corresponds to a violation of the second law of thermodynamics, as — as we discussed in Chapter 10 — Evans and his colleagues at the Australian National University have already experimentally proven that the second law can be violated up to micron scale and for times of up to two seconds.<sup>287</sup> At the much smaller fundamental charged particle level and far shorter "switching" time of one spin completion, the probability is 100% and a certainty that the second law is violated. Hence the broken symmetry of the charged particle considered in the modern sense as a dipolarity (considering its associated **clustering** virtual charges of opposite sign).

**Either** way, the classical Maxwell-Heaviside theory must be changed. Every charge and every dipole — which themselves are Maxwell-Heaviside EM systems *a priori* — refutes the erroneous argument that no Maxwell-Heaviside system can output more energy than the operator himself inputs from an external power supply. To adamantly continue to challenge something already *experimentally demonstrated* by every charge and dipole in the universe is the epitome of scientific blindness.

As have others, Sen {641} called this source charge paradox the "most **difficult**" problem in electrodynamics. However, the basis for its solution - absorption and transduction of virtual KM energy from the vacuum via

the broken symmetry of a charge or dipole in its vacuum energy exchange — has now been known in particle physics for nearly a half-century {642a-642d}. It is not included in the Maxwell-Heaviside-Lorentz theory. Neither the proven vacuum interaction with Maxwellian system nor the broken symmetry in that interaction has been added to the model.

The present author has proposed an EM wave solution {643} to the source charge problem, by reinterpreting Whittaker's {644} decomposition of the scalar potential (as between the ends of a dipole) and treating the "isolated charge" and its clustered virtual charges {645} of opposite signs as a set of composite dipoles. Each of the dipoles then becomes a broken symmetry in the energetic exchange with the vacuum. Hence the charge pours out observable EM energy with no *observable* energy input because the input energy is in virtual photon form.

In the solution, the EM energy is input to the charge or dipole from the time-domain, so conservation of EM energy flow is upheld in 4-space, while time-like symmetry and space-like symmetry are broken individually. Powerful support for the proposed solution was given in a quantum field theory argument by Mandl and Shaw {646} nearly three decades ago. We challenge any scientist skeptical of  $COP > 1.0$  Maxwellian systems to produce a solution of the source charge problem in Maxwell-Heaviside-Lorentz theory alone. In conventional theory, every charge in the universe experimentally exhibits  $COP = \infty$ . Any theory conflicting with a replicable experiment is falsified a priori.

### 11.2.2 EM Waves Imply Curved Spacetime

The oscillating energy of an electromagnetic wave is continuously changing its local spatial energy density. This is an *oscillating change of spacetime curvature* if one accepts general relativity (GR). Hence the EM wave in space is *always* moving in a locally curved spacetime; else, no EM wave exists because no change in spatial energy density exists. To reject that, is to reject GR in its entirety as well as all the experiments consistent with GR. If one accepts GR, then the classical U(1) EM *assumption* of the EM wave moving in a fiat spacetime is a non sequitur. It is unscientific to be suspicious of a higher group symmetry O(3) electrodynamics which *does* correct this known non sequitur in U(1) electrodynamics, while limiting oneself to U(1) electrodynamics *with* that known error. One might as well be suspicious of tensor algebra because it is more comprehensive than vector algebra.

There are many EM experiments such as the Aharonov-Bohm effect {647a, 647b} which violate Maxwell-Heaviside EM, as is well known

{648, 649a-649i}. The foundations of the Maxwell-Heaviside theory are well over a century old, and Maxwell's theory was substantially truncated in the 1880s (more on that below). The considerable physics developed since then has required dramatic extensions to the Maxwell-Heaviside theory such as developing non-Abelian gauge field EM theory, quantum electrodynamics, and modeling of the interaction of vacuum and matter in any material system.

### 11.2.3 On EM Systems with COP>1.0

Conservation of energy requires that all energy output by an inert system must be input to it {650}. It does not require that the *operator* input all or even any of the energy utilized. The active environment can permissibly input part or all of it, else there could be no such thing as a windmill — or a charge, or a dipole, or a solar-cell electrical power system.

The *coefficient of performance* (COP) of a system compares the system's useful energy or work output to the *operator's* energy input. The *efficiency*

$\mathcal{E}$  of a system compares its useful output to its *entire* energy input. No inert system can output more useful energy than its total input, hence

$\mathcal{E} \leq 1.0$ , being  $\mathcal{E} = 1.0$  for a theoretically lossless "perfect" system and

$\mathcal{E} < 1.0$  for a real system with losses.

Whether the operator must input all the energy that is output by the inert system depends upon whether the system is (i) an open system in disequilibrium with its active environment, and (ii) *designed* to accept and utilize excess energy from that environment, such as from the active vacuum. If appreciable environmental energy input is received and utilized, then a system with losses may permissibly exhibit COP>1.0, even though its efficiency  $\mathcal{E}$  is  $\mathcal{E} < 1.0$ . The common home heat pump is an example. While the efficiency of a home heat pump may be  $\mathcal{E} = 50\%$ , its **COP** may be COP = 4.0.

As does the skeptical scientist, the electrical engineering community erroneously assumes that an inert electrical power system that outputs more energy than *one oneself* inputs to it — e.g., a generator outputting more EM energy flow than the magnitude of the mechanical energy input to the generator shaft — is against the laws of physics. To the contrary, it is permitted by the laws of physics and thermodynamics, *once the modern Vacuum interaction is included and disequilibrium exists in the interaction between vacuum and system*. Not only is it permissible, it is a universal fact once the arbitrarily discarded Heaviside energy flow component is re-accounted, and the source charge problem is reluctantly placed back on the

table. If we account all that EM energy pouring freely from the source charges in any EM circuit, then the actual output of EM energy from that circuit is enormous. It is many orders of magnitude greater than the magnitude of the input energy that the experimenter or operator provides.

We do not have to reprove the active vacuum; it has long been proven in particle physics. We also do not have to reprove the disequilibrium between electromagnetic systems and the active vacuum environment; that also has been proven since 1957 by the prediction and discovery of broken symmetry. One of the proven broken symmetries is that of opposite charges, such as are on the ends of a dipole. Hence every dipole or dipolarity in electromagnetics already freely absorbs virtual photon energy from the vacuum, transduces (coherently integrates) it into observable photon energy, and re-emits observable EM photons in all directions at the speed of light. If there are no COP>1.0 Maxwellian systems, then there can be no Maxwellian charges, dipoles, or dipolarity, and therefore no resulting fields and potentials from these sources — an absurdity falsified by every standard two-wire electrical circuit and ever charge and dipole in the universe. Any potential is a dipolarity, hence exhibits broken symmetry. That is why from any finite potential, as much EM energy as desired can be intercepted and collected, by the simple equation  $W = \phi q$ , where  $W$  is the collected energy in joules,  $\phi$  is the scalar potential intensity in joules per unit point static coulomb, and  $q$  is the intercepting charge in coulombs.

Systems far from equilibrium in their energy exchange with their active environment {651a, 651b} can permissibly perform five important functions impossible to equilibrium systems. Such a disequilibrium system can:

- (1) Self-order,
- (2) Self-oscillate or self-rotate,
- (3) Output more energy than the operator inputs (the excess energy is freely received from the active environment),
- (4) Power itself and its load (all the energy is freely received from the active environment), and
- (5) Exhibit negentropy.

Any charge or dipole already exhibits all five of these functions — forbidden by classical thermodynamics but permitted by the well known

thermodynamics of systems far from equilibrium in their exchange with their active environment {651a, 651b}.

*It only takes one small white crow to prove that not all crows are black.* The known performance of the charge and the dipole totally refutes the notion that no EM system can output energy without operator-arranged input from other than the active vacuum. The entropy-consuming reactions from the fluctuation theorem, experimentally proven by Evans et al. in 2002, also is a sufficient proof to destroy any argument against permissible COP>1.0 EM systems. Since all the EM field energy and potential energy in a power system or circuit must come from the source charges and dipoles, it follows that all our EM energy systems already take *all* their EM energy from the active vacuum, *not* from the operator's input. A solar cell array also refutes the notion that the operator has to input the energy, but the solar cells' environmental energy input may not be ubiquitous or dependable. The active vacuum is both.

Most power system electrodynamicists avoid the particle physics solution {652} to the source-charge problem {641} involving disequilibrium exchange with the active vacuum. Instead, they adhere strictly to the Maxwell-Heaviside-Lorentz theory with its *assumed* equilibrium between system and vacuum. Therefore they avoid modeling the vacuum interaction and solving the problem of open dissipative EM systems which freely and dependably receive energy from their vacuum environment in unusable form, translate it into usable form, and furnish it for further **capture** and use. They therefore cannot resolve the source charge problem in **their** model, for the model has already artificially excluded the solution.

By definition, an EM system in equilibrium cannot output more useful energy than the operator inputs. However, considered as an *energy transducer*, every EM system is in disequilibrium with the vacuum **because** of the charges and dipoles in the system, and it continuously receives energy from the vacuum. Because of the broken symmetry of the **charge** and the dipole, some of this energy from the vacuum is discharged by every charge and every dipolarity in the circuit as observable energy *a priori*. This creates a truly enormous outpouring of rather disorganized (in this case, *uncollected*) EM energy extracted from the vacuum and poured out without being intercepted and diverged into the circuit, where it is

organized for dissipation and use. The circuit "uses" only that amount of this enormous available outpouring EM energy that it first organizes (collects) and directs. That is its "organized excitation" energy, commonly known as *input energy* macroscopically — the Poynting energy flow component.

Upon completely discharging its excitation (input energy), the inert system outputs all its received (organized) energy, from whatever source. So every EM system already outputs far more energy than the experimenter inputs — when the system's *nondiverged, non-organized, and nondiverged* output energy flow is considered as well as its *diverged, organized, and collected* energy flow component. The fact that the *diverged Poynting* energy received in the external circuit enters the circuit from the surrounding space is shown by Krauss {653} (See Figure 1-1 in Chapter 1). We show it in Figure 2-4 of Chapter 2 as well. The remaining and nondiverged Heaviside energy flow component in space, which misses the circuit and is wasted, is also shown in Figure 2-4 of Chapter 2 and contrasted to the diverged (caught) Poynting component. To understand this experimentally demonstrable fact {653}, we need a bit of EM history.

## 11.3 Truncations of Maxwell's Theory and Discard of System Classes

### 11.3.1 Concept of EM Energy Flow Through 3-Space

The concept of the connection of EM energy and space did not occur until 1876 in a faulty work by Croll {654}. In the 1880s Heaviside {655} showed the huge nondiverged component filling all space around a circuit (see Figure 2-4 in Chapter 2). Poynting {656} never even considered the external nondiverged flow missing the circuit, but assumed only the *diverged* energy flow component that enters the circuit. Figure 2-4 in Chapter 2 shows both components of EM energy flow laterally, so they can be seen clearly.

It is stressed that the Heaviside nondiverged component of EM energy flow around every circuit is far greater (by many orders of magnitude) than the circuit's intercepted, diverged, and collected Poynting energy flow component. This follows from Heaviside's own original papers. So when the entire output energy flow is considered, every generator and every battery is already a  $\text{COP} \gg 1.0$  *energy transducer*, outputting far more energy flow than the rate at which mechanical energy is input to the generator shaft or the rate at which chemical energy is dissipated in the battery.

In the 1880s the electron, atom, nucleus, special and general relativity, quantum mechanics, quantum electrodynamics, and active vacuum had not been discovered. There was no knowledge of any possible active vacuum interaction source for such an enormous energy flow pouring from the terminals of the generator or battery and surrounding the circuit, filling all

space around it. Heaviside's extra energy flow component was thus shocking and inexplicable, smacking of "perpetual motion" and total violation of the conservation of energy law. Heaviside — a brilliant, self-taught hermit who never attended university - spoke cautiously and obliquely of its magnitude in terms of angles with respect to a reference direction {657}.

### 11.3.2 Elimination of the Non-Intercepted Energy Flow Component

A perplexed and concerned Lorentz {658} cut the Gordian knot and arbitrarily *discarded* the Heaviside nondiverged component, eliminating the quandary. Lorentz stated that the huge nondiverged component had "no physical significance" (his phrase) since it powered nothing. Of course it **has** no physical significance, and powers nothing, unless one intercepts it and uses it!

By analogy, the component of a great wind on the ocean that is *outside* the intercepting sails of a single sailing ship, does not contribute to further powering *of that ship*. Figure 2-5 in Chapter 2 shows that situation. However, that nondiverged wind component can power a whole flotilla of **additional**, *separate* sailing ships with separate sails, as we showed in Figure 2-6 in Chapter 2. Electrodynamacists {659} have continued to utilize Lorentz' clever integration trick (Figure 2-3 in Chapter 2) to dispose of the huge nondiverged Heaviside energy flow component surrounding **every** circuit and missing it, and therefore pouring from the terminals of every generator. Most electrical engineers today do not realize that the original purpose of Lorentz's integration of the energy flow vector around a closed surface assumed surrounding every volume element of interest was merely to get rid of that perplexing and bothersome Heaviside nondiverged energy flow component while retaining the Poynting diverged energy flow component.

### 11.3.3 Lorentz's Previous Discard of all COP>1.0 Maxwellian Systems

Previously (circa 1890s) Lorentz had symmetrically regauged Heaviside's **equations** that had already seriously curtailed Maxwell's seminal equations of 1865. This Lorentz symmetrical regauging retained only that class of EM systems that are in equilibrium in their seething energy exchange with their active vacuum environment. It discarded that entire permissible class of the Maxwell-Heaviside systems far from equilibrium with the active vacuum. In short, it *arbitrarily* discarded all COP>1.0 Maxwellian **systems**, and all those even *permitted* to exhibit COP>1.0.

The ubiquitous use of closed current loop circuits containing both the **external** circuit and the source dipole inside the generator forcibly applied

(and continues to forcibly apply) the Lorentz symmetrical regauging. Thus all electrical engineers began using circuits which self-enforced equilibrium in the vacuum exchange, so that no *net usable energy*<sup>306</sup> that could translate electrons and do work in an external load —could be received from that source.

However, so long as the enormous Heaviside nondiverged energy flow component outside the circuit remained, then separate outrigger antenna circuits and systems could always be inserted in this external energy flow to divert some of it into separate additional circuits. This would have opened up the COP>1.0 *ensemble* of systems and separate outrigger receiver circuits (with separate loads) fed by a single central generator, such as one version of the motionless electromagnetic generator of Chapter 7.

Consequently Lorentz integrated the entire energy flow vector around a closed surface assumed around any volume element of interest {658}, as shown in Figure 2-3. This integration trick — still universally applied {659a-659c} in all the texts today — arbitrarily discarded that troublesome and massive Heaviside energy flow component that could not be explained, and for which no source was known.

<sup>306</sup> Lorentz symmetrical regauging does indeed require that the system receive excess energy from the environment (the active vacuum). It requires that the potential energy of the system is changed twice and continuously, which means the excess energy in each of those two changes must continuously enter from the active vacuum and do internal work on the system. Two new free force fields are created, each with its field energy, which is additional energy being continuously dissipated in the circuit to perform continuous work. However, the two free changes of energy in the system have been precisely selected so that these two force fields are equal and opposite. The two free changes of energy thus produce a *stress potential* without a net translation field. This means that the local spacetime has been curved, in a manner representing a rotation of the system frame away from the lab observer's frame. Further, the stress potential represents the continuous entry of extra stress energy from the vacuum, whose two force fields continually perform opposing local *internal work* within the system to stress it, while unable to translate electrons and power external loads. Contrary to the received view, the Lorentz-regauged Maxwell-Heaviside system is a dramatically altered and different system than the original system before the arbitrary application of the Lorentz condition. The system's inertial frame has been rotated, it has taken on extra energy from the vacuum that can only be used to do internal work upon the system, and that internal work on the system is continuously being done to increase the system's stress and hold it at the new level.



### 11.3.4 The Heart-Breaking Result of Lorentz's Actions

The combination of these two actions by Lorentz — symmetrical regauging of the model equations and discarding the excess Heaviside nondiverged energy flow component — unwittingly resulted in the design and building of only those electrical power systems which symmetrically and automatically regauge their discharge of their excitation energy. The symmetrical regauging is self-applied by the closed current loop circuit.

That circuit uses half of its collected Poynting energy to destroy the source dipole in the generator, and the other half to power the loads and losses in **the** external circuit {660}. Conventional EM systems are unintentionally designed to destroy their own source dipoles — and their free extraction of organized EM energy from the vacuum — faster than they power their loads.

### 11.3.5 Agreement with Classical Equilibrium Thermodynamics

These curtailments of Maxwell's theory resulted in the exclusive building of equilibrium EM systems. These systems obviously obey the classical equilibrium thermodynamics with its infamous second law. Lorentz had unwittingly discarded all that entire class of Maxwellian systems in disequilibrium in their exchange with their active vacuum environment; in those days, there was nothing known about an "active vacuum environment" or broken symmetry in its virtual energy flux. Consequently, Lorentz had discarded all those Maxwellian systems that *do not* obey classical equilibrium thermodynamics, but do obey the newer thermodynamics of systems far from thermodynamic equilibrium with their active environment. He discarded all permissible  $COP > 1.0$  Maxwellian systems.

However, there was a total agreement between all the EM systems actually built using Lorentz's symmetrized equations and all measurements in their ubiquitous closed current loop circuits — all self-enforcing the Lorentz condition. This led to the iron dogma that all EM systems must inevitably **comply** with classical equilibrium thermodynamics — the circuits that were built *were* repeatedly and universally observed to do so!

### 11.3.6 Dogma that $COP > 1.0$ EM Systems are Perpetual Motion Machines

Finally, this total agreement (now for more than a century) between the theoretical model used, the circuits actually built, the measurements **performed**, and classical equilibrium thermodynamics led to the present fallacious but iron dogma that EM circuits and power systems cannot **output** more energy than we ourselves input. Today the vast majority of scientists consider it absolutely proven that **the** laws of nature prohibit

COP>1.0 electrical power systems, and particularly prohibit self-powering systems that freely power themselves and their loads (i.e., EM systems analogous to "windmills in a free wind"). As we stated, every charge and dipole falsifies the "COP>1.0 EM systems are impossible" dogma, as does the fluctuation theorem and its experimental proof by Evans et al.

Sadly, no one seems to have realized that we do not presently have COP>1.0 electrical power systems only because engineers have specifically designed and built their EM systems to destroy their own source dipole faster than they power their load. Ironically, every circuit and every power system used and measured by our engineers already outputs far more EM energy than is input by the operator or by turning the shaft of the generator, if the Heaviside nondiverged energy flow component is re-accounted. The Bohren experiment clearly proves it experimentally {662}, along with thousands of other similar experiments in "negative resonance absorption of the medium" {157a-157d}.

## 11.4 Examples of COP>1.0 Electromagnetic Systems

The motionless electromagnetic generator (MEG) {661} (Figure 11-1) does catch and use some of this available free energy, as explained below. So does the familiar Bohren experiment {662a, 662b} by resonating each intercepting charge so it sweeps out an increased geometrical reaction cross section in space, reaching past the usual Poynting interception cross section (for a static charge) and thereby absorbing additional energy from the otherwise non-intercepted Heaviside energy flow component.

Every charge and dipole in the universe also already acts as an electrical "windmill in a free wind," having a COP =  $\infty$ .

The present author has also nominated the long-neglected but vast nondiverged Heaviside EM energy flow, accompanying every field and charge interaction, as the long-missing source of some 90% of the gravity holding the arms of the spiral galaxies intact {663}. Our *supersystem* examination of several COP>1.0 EM systems developed by various inventors has also uncovered a proposed solution for the source of the distant antigravity accelerating the expansion of the universe {664}.

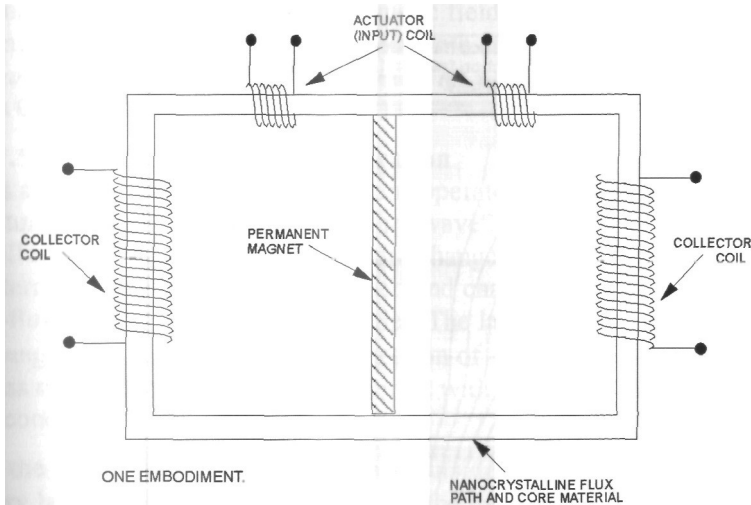

Figure 11-1. Transformer section of the MEG.

Experimental proof that EM energy  $COP > 1.0$  is both possible and demonstrated is already in the literature — e.g., as in the Bohren experiment {662} which outputs 18 times as much energy as one inputs (see Figure 11-2). As another experimental example, the Aharonov-Bohm (AB) effect {647, 665, 666} freely adds additional nonlocalized field-free A-potential energy while all the magnetic B-field energy is sharply localized but still present and available. The AB effect is routinely implicated in physics, but apparently was never applied in an electrical power system prior to its use in the motionless electromagnetic generator

Bohren's experiment {662} was quickly and independently replicated by Paul and Fischer {667}. It can be replicated by any university laboratory at will, totally negating the conventional  $COP < 0$  assumption. The AB effect is also easily replicated, using a toroidal coil, a long solenoid, or a permanent magnet and the special cores used in the MEG. When the toroid system's *total available output energy flow* is measured and accounted — including both the confined magnetic field energy flowing inside the toroidal windings and the field-free A-potential flowing outside — the toroidal coil system outputs more energy flow than the operator furnishes from his external power supply by conventional accounting {668}.

At or near resonance frequency, in the case shown the energy collection fraction (reaction cross section) increases dramatically.

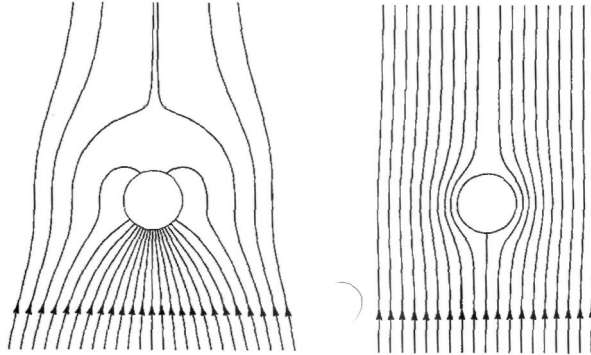

Figure 11-2 The Bohren experiment outputs 18 times as much energy as one inputs

In conventional terms, for a theoretically perfect toroid the operator only "pays for" the magnetic field energy "output component" confined inside the toroidal windings. The presence of an extra energy output component outside the toroid produces  $COP > 1.0$  performance as *an energy transducer*. It *does not* produce system  $COP > 1.0$  performance in a closed-loop circuit containing the primary power supply's source dipole.

The AIAS has previously nominated more than a dozen mechanisms as promising  $COP > 1.0$  systems for investigation, research, and development {669}.

## 11.5 Motionless Electromagnetic Generator (MEG)

### 11.5.1 Overall Description

In the MEG {661} (Figure 11-1), one uses a nanocrystalline material core path with the unique characteristic of drawing in almost all the magnetic field energy of an emplaced permanent magnet. The B-field flux from the magnet is withdrawn from its normal position in surrounding space and sharply confined to that material core path. Around the core there freely appears an *additional* curl-free magnetic vector potential A energy flow, since the surrounding spacetime is still curved due to the interaction exchange of vacuum and magnet dipole, and therefore still contains extra energy. The operator inputs no energy whatsoever after the magnet is once

emplaced, yet has appreciable magnetic field energy and field-free magnetic vector potential energy available to utilize. As an *energy transducer*, the MEG has a  $COP \gg 1.0$ . As a power system powering loads, its  $COP > 1.0$ .

### 11.5.2 An Example of MEG Operation

As a replicable example, suppose one operates the MEG core at less than saturation, and places a small "square wave" pulsed signal upon a primary coil wound around the core. The core changes its permeability as the internal magnetic B-flux is perturbed and changes, so all the perturbed B-flux is retained in the core material. The large E-fields produced by the changing B-flux in the core as a function of  $-\partial \mathbf{B} / \partial t$  are *not* localized, but pass readily out of the core and interact with the coils, particularly with the secondary.

In the A-potential region in the space outside the core, one also produces very large E-fields by  $\mathbf{E} = -\partial \mathbf{A} / \partial t$ . At the frequencies being used (40 to 80 kHz nominally), all these E-fields produced by the core flux perturbations and by the external A-potential perturbations are essentially in phase. The large E-fields thus coherently add and interact directly with the secondary coil acting as a receiver.

In the secondary, the very large and sharply changing E-fields interacting with the coils also produces large B-field flux changes in the core. However, again the core changes its permeability and holds-in all the extra B-flux. The changes in that secondary B-flux also make additional non-localized E-fields, and so on.

The surprising and shocking result is that the transformer secondary undergoes a coherent, purely E-field reaction with the electrons in its coils. This results in the output voltage and current being in phase (within  $2^\circ$ , since there are inevitably some small remaining inductance effects due to a tiny bit of external B-field leakage from the junctures of the ends of the permanent magnet with the core material).

The magnitude of the powerful E-fields produced by these processes — and interacting with the secondary coils — depends on the rise and decay times of the input signal's pulse edges. So the *average* power input to the signal coil may be small, but — using sharp rise and decay times of the input pulses — very large E-fields will be produced in the adjacent surrounding space outside the transformer section and interacting with the secondary coils, as well as in the sharply changing B-flux localized in the core.

One then uses transmission-reception theory and near-field antenna theory for separate receiving circuits containing loads, added in the large E-field region in space outside the core. Those E-fields arise from both the changing A-potential outside the core and the changing localized flux inside the core. We stress again that the E-fields produced in the core are not localized, but pass outward into the external space to interact with whatever interceptor/receivers are placed out there.

A "outrigger array" version of the MEG uses separate external receiving circuits, containing loads, to intercept, collect, and use more of the EM energy available in the surrounding space outside the core.

Within physical space limits, the energy intercepted and utilized by these *separate, independent receiving circuits containing loads* can be increased by adding more receiving circuits with loads or adjusting the rise and decay time of the input pulses to provide greater collected voltage. These *separate* loads will be powered by the incident E-fields' interception in the external receiving circuits. This is not at all a *transformer* action, but a *near-field transmission and separated multiple antenna circuits' reception* action.

There is no back-current coupling between the external circuits and loads with the primary circuit of the transformer section. In the external A-potential region alone, the secondary coil in the transformer section will interact with the large incident E-fields from that adjacent space and from the changing B-flux inside the core, producing at least as much energy as one inputs to the primary. Actually, that process alone will produce more output energy in the secondary than the operator inputs in the primary.

If one operates the core below saturation, the magnetic flux in the core will also be switched, giving additional intercepted E-field energy in the secondary coil attached to its load. The total work out in all loads is permissibly greater than the total energy dissipated in the input by the operator's energy input {668}. The MEG is an open system far from equilibrium with the active vacuum {670}.

### **11.5.3 The MEG Is Replicable**

Any university laboratory can replicate this effect, and demonstrate more work in resistive loads than is input to the MEG primary from the external power supply. For replication, we suggest initially designing to COP = 1.5, since beginning at COP = 2.0 there *can* be other effects not in the U(1) EM literature, but which are dealt with in the actual MEG. Some of the methodology {671} used for COP >2.0 is still proprietary information not

yet releasable due to patent law requirements, while some of it was included in Chapter 7.

Without elaboration we advance the *supersystem* concept, and strongly insist that, to properly analyze the performance of any similar EM circuit or system, one must analyze the dynamics of the entire supersystem consisting of (i) the physical system and its dynamics, (ii) the curved local spacetime and its dynamics, and (iii) the local vacuum and its dynamics {672}. All three components of the supersystem are mutually interacting.

For a  $COP > 1.0$  system, the mutual interactions are utilized from disequilibrium processes evoked between all three supersystem components. U(1) electrodynamic analysis system in an inert vacuum and a flat spacetime is insufficient. Previous AIAS analysis {661} has addressed the supersystem by use of higher O(3) symmetry electrostatics to include vacuum dynamics (energy currents, both space-like and time-like) and curved spacetime dynamics.

## 11.6 Physical Considerations of Gauge Freedom

Additional physical considerations must be accounted when *gauge freedom* is invoked or utilized with respect to physical systems. Applied to electrostatics systems, gauge freedom assumes the ability to freely change any potential of the system being studied. From the physics of the situation, a system potential change concomitantly assumes changing the *potential energy of the system itself* for which gauge freedom changes are being theoretically applied to system-descriptive equations.

If one *can freely increase* the potential energy of an EM system, the extra energy has to come from a physical asymmetry of the system with its active environment — the active vacuum. Else, one must surrender the conservation of energy law. At worst, gauge freedom would then imply the creation and destruction of energy at will. At best, it would imply a return to the view that potentials are mere mathematical conveniences with no physical reality — a notion falsified for decades by the AB effect {647}. *freely decreasing* the potential energy of the system by simply depotentializing it, has a similar vacuum asymmetry requirement for de-excitation of the system, where energy must flow from the system to the vacuum.

## 11.7 Special Modeling of the Vacuum

Having EM energy density, the vacuum *is and should be modeled as* a scalar potential of great magnitude. For deeper (supersystem) analysis, one will also have to examine the internal EM longitudinal phase conjugate wavepair structure and dynamics of the scalar potential vacuum {672}, along the lines shown by Whittaker {644} in 1903 and re-interpreted by the present author {643} in 2000. From quantum field theory arguments, Mandl and Shaw {646} give strong support to the proposed reinterpretation. They argue that neither the scalar (time-polarized) photon, nor the longitudinal photon is independently observable, but the combination of the two is observable as the instantaneous scalar potential.

Transforming this argument to EM waves yields a solution consistent with the reinterpretation {643}. The result is that all 3-space EM energy comes from the time-domain, in a manner not previously utilized in EM circuit analysis. It is experimentally established by proving (measuring) that the source charge and dipole do not *receive observable* EM energy in 3-space, but continuously *output* observable EM energy in 3-space. Simply making and destroying dipoles in an electrical system turns out to be a method for direct engineering of negentropy and entropy respectively — or, from another viewpoint, it directly engineers regauging.

The greatest unrecognized problem in conventional electrical power system engineering is its total failure to include the making and destroying of dipoles as direct engineering of negentropy and entropy respectively.

Every EM potential in an EM system is a change to the energy density of the ambient vacuum potential — and thus is a spacetime curvature — or it is a change to an intermediate potential that *is* such a vacuum potential change. Vacuum exchange with every EM system and asymmetry in that exchange, is ubiquitous and cannot be prevented. Whenever one makes or changes an EM potential, field or wave, and whenever one regauges, one invokes and utilizes asymmetry in the interaction of the active vacuum and the system, either wittingly or unwittingly. Else one must discard the conservation of energy law altogether. There is no symmetry of a mass system alone {673}, without including the vacuum's asymmetrical interaction with it. The reason is simple: all observables involve asymmetry {674} *a priori*, and mass is an observable.



## 11.8 Every Charge and Dipole in an EM System Receives and Transduces Vacuum Energy

In particle physics, every dipole — and every charge considered with its associated clustering virtual charges of opposite sign — is recognized as an asymmetry in the vacuum flux {675}. The very definition of broken symmetry means that a charge or dipole receives and absorbs virtual photon energy from the vacuum, transduces it into observable form, and re-radiates it as real, observable EM energy. This results in an observable outpouring of 3-energy from the charge or dipole, with no observable 3-energy input.

To save the conservation of energy law for physical EM systems, one must therefore recognize and model the *physical vacuum asymmetry mechanism* **that** allows this demonstrated performance of charge and dipole. In electrical power systems, that required asymmetry mechanism is the known broken symmetry of the vacuum's interaction with the source dipole created in the generator.

## 11.9 Energy from the Vacuum Powers Every Electrical Power Line and EM Circuit

### 11.9.1 What the Generator Powers and What Powers the Circuit

Shaft power input to a conventional generator allows the generator to **produce** its source dipole, nothing else. The generator does not transduce any of its input shaft mechanical energy to add EM energy to the external circuit connected to its terminals. Instead, it first transduces its mechanical shaft energy input into internal magnetic field energy.

Then it totally dissipates that magnetic energy to separate its own internal **charges**, forcing the positive charges in one direction and the negative charges in the other, making the source dipole connected to its terminals. That is all that the mechanical shaft power input to a generator does — and **that** is all that burning hydrocarbons, consuming nuclear fuel rods, **damming** rivers for power stations, putting up windmill-powered **generators**, using solar energy input to solar cells, or consuming chemical energy in a battery accomplishes.

*Once made*, the source dipole — via its broken symmetry in its vacuum exchange - freely receives and absorbs enormous virtual photon energy **from** the active vacuum, transduces it into observable (3-space) form, and pours out real, observable EM energy in 3-space from the generator terminals to which it is connected. As shown in Figure 1-1 of Chapter 1,

this outpouring of EM energy from the generator terminals fills all space around the external circuit {653} with a vast energy flow almost parallel to the conductors. Figure 2-4 is a lateral view so that the two flow components can be clearly seen and compared.

### 11.9.2 Gedanken Experiment

We advance a gedanken experiment to illustrate. Consider a perfect generator with no losses, and with two perfect conductors and a purely resistive load  $R_1$  connected across its terminals. Call the mechanical energy input to the shaft of the generator  $W_{in}$ . Call the Poynting diverged energy flow component  $W_r$  that is intercepted by the attached circuit and powers  $R_1$ . Call the Heaviside nondiverged energy flow component  $W_h$  that misses the circuit and is wasted. As an *energy transducer*, the total energy output  $W_{out}$  from the terminals of the generator is

$$W_{out} = W_r + W_h \quad [1]$$

However,  $W_{in} = W_r$ , for this theoretically perfect system. So

$$W_{out} = W_{in} + W_h \Rightarrow W_{out} > W_{in} \quad [2]$$

Further, when accounted,  $W_h \gg W_{in}$ , so

$$W_{out} \gg W_{in} \quad [3]$$

We conclude that all EM systems — *as energy transducers freely extracting and transducing EM energy from the active vacuum*— already exhibit  $COP \gg 1.0$ . However, for *useful work* in a closed current loop circuit, the  $COP = 1.0$ , unless additional antenna-receiver circuits or another scheme such as Bohren charge resonance is used to increase the energy collected and dissipated in the load while *not* increasing the energy used to dissipate the source dipole.

## 11.10 Significant Developments in Negative Resistance

True negative resistance (e.g., current moving against the voltage) also exists and is experimentally replicable. In true negative resistance, the current in a circuit moves against the voltage instead of with it, suggesting time-reversal effects in the mechanism by which EM force and charge interact.

### 11.10.1 Chung's Negative Resistor and Naudin's Replication

Chung {676} has reported replicable negative resistance in the interfaces between layers of carbon fibers in a composite material. By varying the

pressure used when the fibers are made, the resistance can be controlled to later be negative or positive as desired. A simpler version of Chung's negative resistor using off-the-shelf materials has been successfully replicated and tested by Naudin {677}. (See Figure 11-3). Naudin's website {677} provides measurements and full details necessary for repetition. He also includes sources of the carbon fiber materials needed for independent replication.

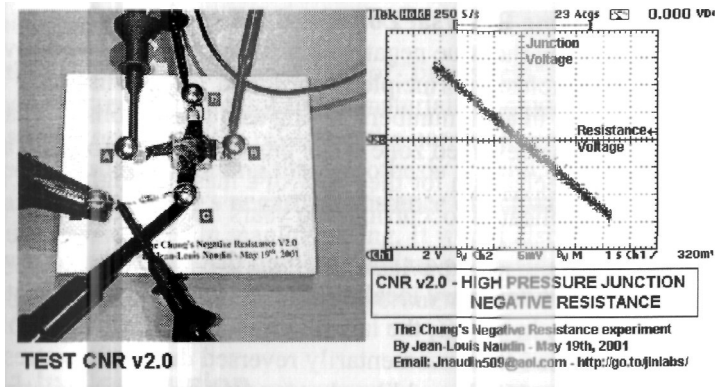

Figure 11-3 Naudin's replication of Chung's negative resistor.

### 11.10.2 The Point Contact Transistor

**There** is also evidence that the original point contact transistor — which used spring pressure on the point contact — often exhibited true negative resistance. Certainly this transistor was never adequately understood {678}, and it is not understood today, since its supersystem has never been analyzed.

### 11.10.3 Kron's Negative Resistor

Gabriel Kron, early pioneer in electrical systems theory, reported **developing** a negative resistor in the 1930s, on the U.S. Navy's Network Analyzer project {679} at Stanford University. He was not permitted to reveal the details of his negative resistor, but did provide strong hints in **certain** statements in his papers in the literature {680a, 680b}. His method for a self-organizing network depended on his "open path" {681} which he also was not permitted to reveal.

The present author worked for some years with Floyd Sweet, a Kron protege, who did produce a successful type of powerful negative resistance system {682} known as the vacuum triode amplifier, apparently based on Kron's original negative resistor. See Figures 6-5 to 6-13 in Chapter 6. As

shown in Figure 6-6, Sweet induced self-oscillation in barium ferrite magnets {683a-683c} (which are made by powder metallurgy methods using pressure applied during their manufacture) and extracted energy by induction from the resulting self-sustained magnetic field oscillations. His device was independently tested by Walter Rosenthal {684}, a senior test engineer of long experience with a major aerospace company. See Figure 6-9 and Figure 6-13.

#### **11.10.4 Proposed Time Reversal Zones and Effects**

One may take the view that true negative resistance involves time-reversal, which by the Pauli exclusion principle is permitted for bosons {685} and possibly for fermions in even numbers, acting as quasi-bosons (perhaps only possible in a time-reversed zone). The present author proposed a photon interaction mechanism for the "flow of a mass through time" in 1971, with initial publication occurring two years later {686}.

Extending this mechanism, the author proposed that *time reversal zones* (TRZs) can occur in momentary local regions in semiconducting materials or electrolytes {687}. In a TRZ, the law of attraction and repulsion of charges is hypothesized to be momentarily reversed due to time-stress or time-domain pumping {688}, and like charges may momentarily attract. In Chapter 10, we used these time-reversal zones to explain the anomalous results of the 600 or so successful cold fusion experiments worldwide. We also gave the exact new nuclear reactions for the production of anomalous deuterium, tritium, and alpha particles in many of these experiments.

When under strong stress, anomalous attraction of clusters of like charges is experimentally known, e.g. in Shoulders' {689} experiments and patented processes {690}. When the output leads of Sweet's vacuum triode amplifier device were suddenly shorted, extreme cooling occurred rather than heating. Ice condensed instantly upon the shorting contact and leads from the sudden extreme cooling of the metal in the moisture in the air, dramatically showing a converging EM energy process rather than a diverging one.

#### **11.10.5 Effects in Optically Active Semiconducting Materials**

In addition, four-wave-mixing, phase conjugation, and time-reversal effects are well known in semiconducting materials {691}, almost all of which are optically active. Optical activity and microlasing is known in semiconductor powder {692}. Further, the vacuum itself can exhibit semiconducting properties {693}.

### 11.10.6 Special Functions Produced by Stress

Apparently pressure (stress) in many of these devices and experiments can play an important role in the negative resistance process. Based on harmonic sets of paired couplings of a longitudinal time-like wave and a longitudinal wave in any scalar potential {643}, the present author hypothesizes that such stress — treated as a stress scalar potential — accomplishes time-domain pumping in the optical sense, due to the presence of the coupled time-polarized longitudinal waves in the time domain.

**This** time pumping is a special form of "time stress". Thus in optically pumped or stressed optically active materials (including electrolytes), the time-stress creates a TRZ, reversing the normal force laws upon and between charges. Assuming this hypothesis is valid, this could account for the variation of Chung's negative resistance effect with the variation of the pressure (stress) used in manufacturing. It would also apply to the laser-created stress in semiconducting powder experiments, etc. The hypothesis should be further investigated for experimental validation or refutation.

### 11.11 In Conclusion

As Penrose {694} states,

*"Electromagnetism is a subject that is in no way closed to stimulating new developments."*

**Indeed**, electrodynamics is still very much an advancing subject, and in classical electrodynamics there are foundations errors and problems, a few of which we have addressed. As Bunge {695} pointed out more than three decades ago,

*"...it is not usually acknowledged that electrodynamics, both classical and quantal, are in a sad state."*

From a foundations viewpoint, Einstein {696} beautifully summed it up — and advanced a requirement for continually examining the foundations of electrodynamics and every other field of physics — in these words:

*".. the scientist makes use of a whole arsenal of concepts which he imbibed practically with his mother's milk; and seldom if ever is he aware of the eternally problematic character of his concepts. He uses this conceptual material, or, speaking more exactly, these conceptual tools **of thought**, as something obviously, immutably*

*given; something having an objective value of truth which is hardly even, and in any case not seriously, to be doubted. ...in the interests of science it is necessary over and over again to engage in the critique of these fundamental concepts, in order that we may not unconsciously be ruled by them."*

Though they have long been neglected, legitimate  $COP > 1.0$  electrical systems are good science, or they can be. They were present in the original Heaviside truncation of Maxwell's theory prior to Lorentz's symmetrical re-gauging. That re-gauging arbitrarily selected only those Maxwellian systems in equilibrium in their exchange with the active vacuum. The energy flow theory was further curtailed by Lorentz's integration trick, which discarded the huge vacuum-furnished non-intercepted Heaviside energy flow component accompanying every EM system. Every EM system already outputs for more EM energy flow than the energy that the operator inputs; thus every EM system is already a  $COP \gg 1.0$  system, with respect to *energy transduction*. The only way this giant negentropy of every EM system can be hidden is to ubiquitously continue that integration trick to discard the giant Heaviside energy flow component.

The present Lorentz-re-gauged Maxwell-Heaviside equations are not consistent with *any* bipolar EM system or circuit. The ends of any dipolarity in the universe — including any electron on Jupiter and any positron in the star Sirius — constitutes a broken symmetry in the seething vacuum flux. Actually, that is what Gabriel Kron discovered and called his "open path". Hence, that "dipole" continuously emits observable EM energy extracted from the vacuum.

Engineering use of the ubiquitous closed current loop to contain both the primary source dipole and the load — which destroys the source dipole and extraction of vacuum energy faster than the load is powered — is responsible for the successful predictions of the equilibrium EM model (which of course completely fails to explain the source charge or source dipole). That circuit is unwittingly designed to self-enforce the Lorentz symmetry condition and therefore self-enforce those predictions.

The question as to whether  $COP > 1.0$  electrical power systems are possible *and practical* must be resolved by direct experiment, and not by established models and cherished concepts that already arbitrarily exclude such systems! Such theoretical refutation by models that in fact contradict the experimentally observed  $COP = \infty$  action of every charge in the universe, cannot be trusted at all with respect to  $COP > 1.0$  judgment. Well-

known supporting and confirming experiments already in the literature — such as the Bohren experiment yielding  $COP = 18$  — have been cited, and these are replicable by any university laboratory. The Bohren-type experiment is well known and routinely performed in every nonlinear **optics** laboratory, under the guise of "negative resonance absorption of the medium".

It is indeed a critical time to re-examine the foundations of our electrical **power** science and engineering, along the lines so eloquently stated by Albert Einstein. With the impending oil crisis, we face a world economic crisis of epic proportions unless we rapidly develop and widely deploy sell-powering disequilibrium electrical power systems.

Also it is a critical time when the leaders of the scientific community — specifically the National Academy of Sciences, the National Science **Foundation**, the great national laboratories, and the universities — must at last face and correct the excruciating *faux pas* that has now been perpetuated in electrodynamic theory for more than a century. In short, the **leaders** of our scientific community must now show whether they are scientists practicing and upholding experimental basis, or are dogmatists **defending** an ancient faith. The fact that the source charge problem **continues** to be propagated in electrodynamics 45 years after the award of the Nobel Prize to Lee and Yang, is no longer excusable.

A thorough review and correction of the foundations of EM theory is **required** for the survival of this nation and much of civilization. It is also **required** for the cleanup of the increasingly polluted biosphere, survival of the threatened species of the Earth, reduction of present global warming **trends**, and the survival of this fragile and beautiful planet itself.

# Annotated Glossary of Selected Terms

action at a distance: An action (effect) occurring in a local system, for which no separate local 3-space cause exists, but for which a causal correlation exists between a distant action and the local effect.

advanced electromagnetic field: An electromagnetic field that is a solution of the classical Maxwell equations, which is positioned on the future light-cone of spacetime. It may be possible to involve such a field in the tempic force that may exist between the tempic potential at the output of an overunity system and the tempic potential that exists at the input of the system, where the interaction of the tempic force with the local nonlinear vacuum drives Dirac sea hole current from output section to input section.

advanced electromagnetic potential: An electromagnetic potential that is a solution of the classical Maxwell equations, and is positioned on the future light-cone of spacetime. Presently this potential has not yet been given a physical interpretation. It may be possible to involve its effects in a specific system by our notion and use of the instantaneous tempic potential difference (the tempic force) that may exist between the tempic potential at the output of a system and the tempic potential at the input of that system if the two differ.

advanced electromagnetic wave: An electromagnetic wave that is a solution of the classical Maxwell equations, and which is positioned on the future light-cone of spacetime.

Aharonov, Yakir: Renowned Israeli quantum physicist and former student of David Bohm. Co-discoverer of the Aharonov-Bohm effect. Together with Bohm, Aharonov authored a fundamental paper in 1959 that pointed out the *primary importance of the potentials* rather than the force fields. The force fields are only made in and of the charged particle system itself, and do not exist as such in the vacuum. The force fields are thus not primary electromagnetic causes at all, but are *effects* due to the interference of potentials in a particular charged particle system.

Aharonov-Bohm effect: Quantum mechanical phenomenon theoretically pointed out in 1959 by Yakir Aharonov and David Bohm whereby interfering electromagnetic potentials can produce effects on charged particle systems, even at a distance and in the absence of the



electromagnetic force fields. A system undergoing a cyclic evolution from an initial state back to it will acquire a phase difference, which can be detected by interfering the initial and final states. Theory was extended later to Berry phase, then again to geometric phase.

In classical EM terms, a more important *energy-amplifying* principle - advanced by the present author — emerges from the AB effect. My colleagues and I have used this principle in our motionless electromagnetic generator (MEG) to provide  $COP > 1.0$ . Consider a source of magnetic field  $B$ , such as a permanent magnet. All the magnetic field energy  $B$  from the permanent magnet may be drawn into and confined in a local material path, as in a special nanocrystalline transformer core. Then in the space surrounding the localized magnetic field energy, the active vacuum will freely replenish — via the broken symmetry of the permanent magnet dipole in its exchange with the vacuum — the magnetic energy in that space that would otherwise have been filled with magnetic field  $B$  (curled magnetic vector potential  $A$ ). However, nature replenishes the energy in space outside the  $B$ -localization region with the *curl-free* magnetic vector potential  $A$ . In this fashion a system designer may cause the active vacuum to provide more available magnetic energy from the permanent magnet than normal, with each of the two energy forms being in separate spatial regions and paths, and occurring in different forms of magnetic vector potential energy. By inputting only a little energy in the input coils of the transformer section, and controlling the rise time and decay time of the pulses, one can produce very large E-fields from the A-potential via  $E = -dA/dt$ . From the simultaneously perturbed confined B-field flux in the core, one also produces E-field simultaneously and — at the frequencies used — in phase with the E-fields produced outside the core. The net result is interaction of large E-fields with the output coil, producing an output power *proportional to the rate of change* of the weak input signal energy rather than its magnitude. In this fashion, additional E-field energy from the vacuum enters the output coils to power the secondary circuit and its loads. Also, the output of the entire transformer section has the voltage in phase with the current, in contradiction to the actions of all previous transformers.

AIAS: Alpha Foundation's Institute for Advanced Study, directed by Dr. Myron W. Evans, a noted scientist with more than 600 papers in the literature. The AIAS is an unusual "think tank" comprised of Fellows and Fellow Emeriti in various places in the world, who cooperate in advanced electromagnetics studies via E-mail. The Director, Dr. Myron W. Evans, is a theorist of note, as are several other Fellows. The AIAS has been forging

ahead with the production of  $O(3)$  symmetry electrodynamics, particularly as an important subset of Mendel Sachs' unified field theory. Dozens of AIAS group-authored papers have been published in various leading journals such as *Foundations of Physics*, *Physica Scripta*, etc. More than 100 AIAS papers are carried on a restricted Department of Energy website for reference by DoE and AIAS scientists. The work is particularly significant in preliminary theorizing how EM energy can possibly be extracted from the active vacuum.

algebras: The various types of mathematics in which the theoretical models for physics and other sciences are embedded. Some important algebras utilized in physics are vector algebra, tensor algebra, quaternion algebra, Grassmann algebra, Pauli algebra, Clifford algebra, etc. There are many others. The complexity of the symmetry and of the topology varies significantly between these algebras. Thus, an electrodynamics model in a lower topology algebra such as vectors or tensors will not reveal or permit nearly so great a set of electrodynamic functions and operations as will electrodynamic embedded in a higher topology algebra such as quaternion algebra or Clifford algebra. See topology.

ambient vacuum: The average or typical "standard" active vacuum (i.e., active spacetime), removed spatially from any large collections of observable charge and observable mass.

ambient vacuum potential: The *average* or typical standard vacuum considered as a scalar potential because it possesses energy density as well as structure and dynamics on many levels. As a scalar potential, the vacuum potential (considered without zero-point fluctuations) decomposes into a harmonic set of "bidirectional" longitudinal EM phase conjugate wavepairs, by Whittaker's 1903 decomposition as reinterpreted by the present author in 2000. Dynamic structuring of the vacuum thus consists of dynamics impressed upon these wavepairs. Since the vacuum is observably mass-free, Whittaker's phase-conjugate half of the decomposition must be considered prior to its interaction with mass, hence in the imaginary plane **and** arising from the time domain. This consideration led to the discovery by the present author of the more fundamental 4-symmetry in EM energy flow between the time domain (imaginary plane) and real 3-space, when broken 3-symmetry is present (as with any dipolarity or with any **potential**).

Powerful support for this solution is also given by F. Mandl and G. Shaw, *Quantum Field Theory*, Wiley, 1984, Chapter 5. Mandl and Shaw argue that the longitudinal and scalar (time) polarizations of the photon are not

directly observable, but only in combination, where they manifest as the "instantaneous" Coulomb (i.e., electrostatic) potential. Our comment is that this argument, translated from particle terminology to wave terminology, directly fits our re-interpretation of Whittaker's 1903 decomposition of the scalar potential.

**angular momentum:** The momentum or "leverage" of the linear momentum of a moving body, with respect to an axis or reference point. Angular momentum has the same units as action; that is, it is energy multiplied by time, or momentum multiplied by length. In terms of particles, it is also known as *spin*.

**anti-circuits:** Somewhat normal-appearing electromagnetic circuits which primarily process and use antiparticles and anti-electrons rather than particles and electrons, or else process a combination of the two simultaneously. Operations of the anti-circuit must be analyzed and understood in terms of its *supersystem* interactions. The circuits process and utilize both negative energy and positive energy EM fields and potentials, hence are closely connected to unified field engineering and antigravity. One aspect enabling such circuits is the use of the supersystem's curvatures of spacetime in both negative curvature and positive curvature fashion so that an appropriate change of spacetime curvature precludes the radiation normally accompanying pair annihilation, etc. The key to the circuits is T-reversal and C-reversal operation, along with the matching use of spacetime curvatures, and also the use of the Dirac "positron" (negative energy electron) — and its fields and potentials — prior to its observation. The unobserved Dirac negative energy electron in the vacuum is an entirely different entity than is the observed Dirac positron after its interaction with charged matter, after which it has become a "lattice hole" or "positive charge on a positive mass ion". The response of normal circuit components to vacuum Dirac sea hole operations is dramatically different than for Dirac positrons, and for certain applications special versions of circuit components are required. At this writing, together with John Bedini the present author has submitted what may be the first patent application on the fundamental process for anti-circuits and their operations with antimatter and negative energy currents, fields, and potentials as well as matter and positive energy currents, fields, and potentials. Another patent application by this author is in preparation, covering the anti-gravity aspects. The details of these mechanisms are still proprietary at this writing in order to protect our intellectual property rights, but limited information is in this book.

**anti-electron:** A negative-energy electron, observed as a *positron*. Under time reversal, electric charge reverses in sign. Dirac did not predict the positron *per se*, but a negative energy electron that we would *observe* in **reversed** fashion. Present theorists assume the interaction of the 4-space **negative** energy electron with matter — i.e., observation — to have occurred. This transforms the negative energy, negative mass electron to a positive energy, positive mass positron traveling in the opposite direction. In so doing, antigravity from the negative energy 4-electron source charge, due to its negative energy EM fields and negative energy potentials, is **arbitrarily** transformed by the spatial reversal into positive gravity fields **rather** than the antigravity fields they were. The secret to practical antigravity is to utilize (in anti-circuits) the negative energy 4-electrons **prior** to observation, *without* transformation of (i) negative energy fields to positive energy fields, (ii) negative mass to positive mass, and (ii) reversal of the field direction. In short, simply consider the unobserved negative **energy** 4-electron as what it is, and utilize it in its unobserved vacuum state. The conventional transformation process also unwittingly discards **the** concept of anti-circuits, anti-fields, anti-potentials, and anti-currents, which discards half the rich electromagnetic circuitry that can be built and **utilized**. In the present book, we only touch lightly on this latter subject, which hopefully will be the subject of a future book after certain patents are **filed**.

**antigravity:** Negative gravity or reversed gravity. Use of negative curvature of spacetime to produce a force on a gravitational source (**physical** system) that is opposite to the normal force of gravity of the earth etc. on that system. Antigravity is achieved by the use of **negative-energy**, negative-mass source charges in the mass component of the **supersystem** prior to observation, while the source charges are still 4-**spatial**. This usage produces negative energy fields and negative energy **potentials** to negatively curve the local spacetime (ST), so that these *negative local ST* curvatures interact back upon the positive mass source system associated with the vacuum negative energy sources in its **supersystem**. Again, to understand the operation of an antigravity circuit or system, one must analyze it in terms of its *supersystem* interactions.

**antimatter:** Matter consisting of atoms that are composed of anti-electrons (**positrons**), antiprotons, and antineutrons and such. Also loosely refers to the **antiparticle** corresponding to a particle; an antiparticle may be regarded as a particle traveling backward in time, or "phase conjugated", or "time-reversed". Since time is not an observable, the observer sees the antiparticle

*{after its observation by interaction with mass}* in forward time as being reversed in direction and charge.

**antiparticle:** Conventionally, a counterpart to an ordinary fundamental particle, *observably* having identical mass, lifetime and spin, but with charge and magnetic moment reversed in algebraic sign. We again point out, however, that the antiparticle differs when in its unobserved 4-spatial state. Only by analyzing the particle's supersystem can the true unobserved antiparticle be understood, as well as its fields and potentials in that condition.

**antiphoton:** A time-reversed photon. Presently the photon is considered its own antiparticle. *Observably* it is, but in its pre-observation condition it is not. An alternate but as yet unaccepted view is that, since the unobserved photon is comprised of  $(dE)(dt)$  — i.e., a piece of energy welded to a piece of time with no seam in the middle, the antiphoton may be assumed to be comprised of  $(-dE)(-dt)$  with respect to the external observer.

**anti-Stokes radiation:** The radiation coming from an anti-Stokes emission process from an intensely scattering medium, wherein more energy flux is emitted than is input by the experimenter-operator. The excess emitted energy is furnished by other processes in the medium. For true overunity operation, the excess energy furnished by the energetic medium must be freely replenished to the medium by the active vacuum's interaction with it.

**antiwave:** The time-reversal (phase conjugation) of a reference wave.

**A-potential:** The magnetic vector potential  $\mathbf{A}$ , conventionally thought to be "defined" by the equation  $\mathbf{B} = \nabla \times \mathbf{A}$ . However, no equation is a definition (an identity is required). If we replace the "=" sign by "=", we have  $\mathbf{B} \equiv \nabla \times \mathbf{A}$ , which is actually seen to define the field  $\mathbf{B}$  as just a curled  $\mathbf{A}$ -potential, or as the curled component of the  $\mathbf{A}$ -potential, *after* interaction with magnetic charge. The  $\mathbf{A}$ -potential or an additional component of it can and does also exist in uncurled fashion, and will emerge in the uncurled state in the space outside any local path (e.g., the path in the interior of a toroidal coil) that retains the  $\mathbf{B}$ -field therein. That process of separating the curl component of the  $\mathbf{A}$ -potential from its uncurled component is known as the Aharonov-Bohm effect (which also affects the wave function). The motionless electromagnetic generator (MEG) uses a special nanocrystalline core material in a transformer configuration, which draws in and retains the  $\mathbf{B}$ -field from a permanent

magnet outside the core but firmly in contact with it on both ends. As a result, the vacuum freely replenishes the withdrawn magnetic energy that would otherwise have existed in the space outside the core, but the energy outside the B-field localization zone remains and appears as a separated and uncurled A-potential. In this way, the MEG is converted to an open system not in equilibrium with the vacuum, and can therefore permissibly output more EM energy in its output coils than the operator inputs into the input coils, the excess being freely furnished from the vacuum via the broken 3-symmetry of the permanent-magnet dipole and the resulting 4-symmetry EM energy flow from the vacuum's time domain into the dipole.

The MEG is actually a practical macroscopic EM power system application of (1) the well-known Aharonov-Bohm effect and (2) the effect of **the** separation of the curled and uncurled potentials by a long tight **solenoid** or by a tight toroid, but in this case by the nanocrystalline magnetic core performing that separation function. In effect, the output **coils** interact with double (or greater) energy than would be available in just the B-field of the core (and of the magnet). Dual interaction with both the internal core B-field flux and also the external A-potential is obtained by pulsing, so that the pulse edges produce strong E-fields in space, with **the E-fields** striking the output coils in a transmission-reception near-field fashion. As is well-known,  $dA/dt = -E$ , and also  $f(dB/dt) = \nabla \times E$ . two

**fields** produced by the perturbed internal B-flux in the core and the perturbed external uncurled A-potential outside the core are in phase. This is how the extra pulsing A-potential energy outside the core is made to **interact** as -E-field energy with the Drude electrons in the output coils, while the changing magnetic flux in the core through those coils also **simultaneously** produces a second -E which interacts with the coil's conductors in normal E-field fashion. The total E-field interacting with the output coils is proportional to the *time rate of change* of the input **perturbation** signal, not the magnitude of its energy. By adjusting the **leading** and trailing edges of the perturbation pulses, the magnitude of the E - field interactions with the output coil is determined as desired. Further,

the usual output B-field produced in the output coils by  $dE/dt$  is directly **extracted** into the core and held, so that *a purely electrical interaction and output occurs in the output coils*. This is easily shown since the output current and voltage of the output coil are in phase, within a degree or two. The MEG may be said to be the world's first purely electrical induction transformer, freely separating the magnetic interactions and bottling them up, while allowing the electrical interactions.

**asymmetrical regauging:** A change of either the scalar potential  $\phi$  or the vector potential  $A$ , or both, so that a *net resulting excess force together with a net change of total system potential energy* occurs in the system. During this change, an asymmetry exists in the active vacuum's energetic exchange with the system. The result is that the potential energy of the system is freely changed by energy from the vacuum, and a free net force is also produced in the system. This new force is then free to dissipate the excess potential energy by translating electrons through a load and powering it. By contrast, the Lorenz/Lorentz *symmetrical* regauging produces two free force fields that are equal and opposite, so there is no *net* resultant translation force available to translate electrons through the external load and power it. Thus Lorentz regauging arbitrarily applied to the Maxwell-Heaviside equations selects only that resulting subset of Maxwellian systems that are in equilibrium in their interaction with the external active vacuum. The potential energy of the system is changed, but only as a "stress potential" doing internal work upon the system to form and maintain its increased stress. The extra energy also rotates the system's frame out of the laboratory frame. Lorentz thus unwittingly discarded an entire class of permissible Maxwellian systems that are not in thermodynamic equilibrium with the vacuum. The Lorentz condition is initially violated each time anyone potentializes an EM circuit, but the closed-current-loop circuit design with the same charged-particle energy carriers around the loop — including back through the back emf of the source dipole in the generator — enforces a form of Lorentz symmetrical regauging during discharge of the system's excitation energy. Further, the response of the electrons in the usual electrical circuit with copper conductors is so rapid that the asymmetrical regauging (potentialization) is almost instantly converted to symmetrical discharging by movement of the electrons as current. When one section of the otherwise closed current loop uses a dramatically heavier charge as the energy carrier (as a battery uses ion current between its plates, but uses electron current between the outside of the plates and the external circuit), it is then possible to dephase the two independent carrier currents so that the battery will be charging while simultaneously the circuit is being powered, by a negative resistor (sharply increased scalar potential or voltage) produced at the plate surface interface of the two carrier current types. This proven Bedini process is an example of a true overunity process, capable of producing a self-powering system by means of adroit switching and timing.

**asymmetry:** Lack of symmetry, or "broken symmetry" in a general sense. Since a specific symmetry is accompanied by a specific conservation law, the breaking of that symmetry represents the violation of that conservation

law. Particularly note that a broken symmetry at one level often (usually) **results** in a new symmetry at a higher level, necessary to maintain the asymmetry at the lower level. The resulting "levels" of symmetry are known as *hierarchies* of symmetry.

**asymmetry of the dipole:** Because of the proven asymmetry of opposite charges, any dipole or dipolarity is a broken 3-symmetry in its fierce exchange of EM energy with the active vacuum, because of the known **broken** symmetry of the opposite charges on its ends. Any two points in **the** universe (in or out of the circuit), that are at differing ambient **potentials**, constitutes such a broken symmetry continuously pouring out EM energy extracted from the vacuum. A dipole or dipolarity continuously **receives** and absorbs copious virtual energy from the seething virtual **photon** vacuum flux, and not all this absorbed energy is reradiated back to **the** vacuum in virtual form. Instead, some of it is coherently integrated into **observable** form and re-radiated in all directions as usable, real 3-space

observable photons and EM energy. We found that the input energy to the **dipole** is from the time domain of 4-space. Hence the dipole's broken 3-symmetry results in the appearance of a new and far more fundamental 4-symmetry in energy flow between the time-domain and 3-space. This was the **solution** to the long-vexing source charge (or source dipole) problem in classical and quantum electrodynamics. Reinterpreting the Whittaker 1903 decomposition of the scalar potential reveals the mechanism for this 4-symmetry between time-domain EM longitudinal wave energy flow into a **dipole** and 3-space EM longitudinal wave energy flow out of the dipole, **due** to the presence of the proven broken 3-symmetry of the dipole. *EM energy flow is conserved in 4-space, but not in 3-space. Further, the 4-symmetry energy flow from the source dipole (or source charge) continues as long as the source dipole (or source charge) remains intact so that the broken 3-symmetry remains intact. It is strongly indicated that this asymmetry of the dipole or dipolarity is what Gabriel Kron finally discovered as his "open path".*

**back emf:** The counter-electromotive force, usually between the end charges of the source dipole in the external power source for an electrical circuit (in its overall closed current loop). When the electrons in the circuit are **forced** against the emf— as when the "spent" or depotentialized charges from the ground reference of the circuit are forced back up **through** the emf of the source dipole to re-potentialize the charges — then work is done upon the source dipole to scatter its charges and destroy the **dipole**. Removing the dipole stops its receipt of vacuum energy from the time - domain (which was due to its broken 3-symmetry, now removed). It



also stops the former dipole's transduction of that energy, and its former output of 3-space energy flow along the circuit and in space around the circuit. When this flow is occurring, a small component of it strikes the surface charges in the conductors and is diverged into the circuit (by axial precession of the surface charges withdrawing the "immediate stubs" of their fields and potentials into the conductor) to power it as the Poynting energy flow component. The huge remainder of the energy flow in space surrounding the circuit simply misses the circuit and is utterly wasted. Destruction of the source dipole removes the transduction of EM energy from the vacuum. It thus stops the powering of the circuit. So additional energy must then be input to the power source to perform work on its scattered internal charges, force them apart again, and reform and restore that source dipole, in order to resume powering the circuit by energy extracted from the vacuum by the dipole. It is simple to show that such a closed loop circuit uses more of its collected energy from the vacuum to destroy its source dipole, than it uses to power its load. Hence the circuit self-enforces  $COP < 1.0$ .

**back emf (tempic):** There are actually two emfs in a circuit, not one. There is a 3-space emf and also an entirely unrecognized *tempic* emf. In either case, under proper circumstances there can be a back-emf of either one or both. See discussions under **electromotive force, back** and under **tempic back emf**. The tempic back emf is very important to  $COP > 1.0$  circuits, where the system's output energy density in spacetime is greater than the energy density at the input section of the system. This difference in tempic stress potential provides a tempic force sweeping from system output section back through the system to its input section. The current is a current of Dirac sea holes (negative energy 4-electrons) moving in that local vacuum, from the output section back through the system to the input section. At the input section, this Dirac sea hole current reacts with incoming electrons from the external power system. It therefore "eats" incoming electrons, so that the power supply must now furnish additional electron current to (a) power the negation and "killing" of the Dirac sea hole current by filling those holes with electrons in the input section of the circuit, and (b) simultaneously furnish the additional usual current to power the system's input. The result is that the tempic back emf is nature's mechanism for decaying the excited  $COP > 1.0$  energy state represented by a system in overunity functioning condition. Unless this hole current problem is overcome, this decay mechanism will destroy the net overunity, and it will prevent any attempt at close-looping the circuit for self-powering by use of clamped and governed positive energy feedback from output to input. The Bedini method can be used to transform the

detrimental Dirac hole current into ordinary electron current, providing the self-powering feedback loop needed. Or, Bearden's outrigger method of using a multi-system set of external  $COP < 1.0$  receiving circuits powered by radiation (Poynting EM energy flow) from a single central power **source** (energy flow radiator) can be used. Then already-positive energy feedback from one or more of the separate outrigger  $COP < 1.0$  receiver circuits can be fed back in normal fashion to power the central power unit. Note that the outrigger concept uses the bridging concept, so that an **external**  $COP < 1.0$  system can be powered from a central radiating system, and the external  $COP < 1.0$  system can collect and output more energy than is output in the *accounted Poynting component* of the central radiating system. The excess energy radiated comes from the radiated Heaviside component.

**bare electron:** The true electron without its partial shielding of virtual **positrons** that are attracted toward it from the active vacuum, and that **cluster** around the electron, partially shielding its charge as seen by an **external** observer. The bare electron has infinite energy and infinite charge, as does the shielding cluster of virtual positrons. The difference between these two infinite values of opposite charge is the finite "externally observed" value of the electron charge listed in texts and handbooks. This strange dipolarity of the source charge thus exhibits an asymmetry in its **exchange** with the active vacuum virtual photon flux. Hence this mechanism also solves the source charge problem — how the charge continuously pours out EM energy in all directions at the speed of light, **establishing** its fields and their potentials reaching out into or even across the universe, without any input of *observable* EM energy to the source

Barret, Terence W.: Noted modern electrodynamicist and consultant who works in  $SU(2) \times SU(2)$  gauge symmetry extended electrodynamics, and **other** models, and was also one of the pioneers of ultrawideband radar, Barret is one of the vigorous modern electrodynamicists continuing to develop and extend the science of electrodynamics and the electrodynamics model itself.

**Bedini, John:** Noted audio engineer, leading overunity energy researcher, inventor of the Bedini process for creating a true negative resistor inside a battery used as primary power to a circuit, and inventor of the Bedini overunity process for killing the back mmf (magnetomotive force) in a **magnetic** motor. Bedini is also the inventor of the renowned Bedini amplifiers well known to audiophiles, the BASE process for holographic sound, and a remarkable process for cleaning the **harshness** from digital

audio disks. In addition, he discovered a mechanism for transducing into usable positive energy the detrimental Dirac Sea hole current (negative energy electron flow) backflow in an overunity system, flowing from the output section back through the system to the input section and even on out into the external power supply. The Bedini process transduces this detrimental current into normal electron current, thereby providing most or all of the required input power to the input section. Bearden then explained the technical process for Bedini's discovered transduction procedure, and Bedini and Bearden filed a patent application on this process.

**Berry phase:** Generalization by Berry of the Aharonov-Bohm effect, for an adiabatic situation. Later Aharonov and Anandan further removed the adiabatic condition and generalized the Berry phase to the geometric phase. See Aharonov-Bohm effect, geometric phase.

**blocking:** In a Fوجل charge-barrier semiconductor, stopping or partially stopping the flow of current in a circuit, or between two points, by *pinning the electrons without stopping the EM energy flow*. In ordinary usage, "stopping the progress of whatever charge flow or current is being referred to.

Bohm, **David J.:** World-renowned physicist and originator of the hidden variable theory and interpretation of quantum mechanics. See David Bohm, "A Suggested Interpretation of the Quantum Theory in Terms of 'Hidden' Variables, I and II," *Physical Review*, 85(2), Jan. 15, 1952, p. 166-179 (Part I); 180-193 (Part II). Together with his student Aharonov, Bohm co-authored a fundamental paper on the Aharonov-Bohm effect wherein interfering electromagnetic potentials can produce effects on charged particle systems, even at a distance and in the absence of the electromagnetic force fields. From Bohm's hidden variable theory, the quantum potential has been highly weaponized by five nations, and these eerie weapons operating instantaneously at a distance through multiply connected spacetime are presently the dominant strategic weapons on earth.

**Bohm's hidden-variable theory (HVT) of quantum mechanics:** A major interpretation of quantum mechanics, formulated by David Bohm and published in *Physical Review* in 1952. Bohm's theory makes all the correct predictions and also eliminates many problems in quantum mechanics, such as the "measurement problem" and the — now recognized — problem of the missing chaos (i.e., the missing "hidden chaotic order."). Bohm's theory implies that physical reality — or much of it — can in fact be deterministically engineered. A key concept is the use of a *quantum*

*potential*, which is multiply connected. Clandestine superweapons using **Bohm's** quantum potential (QP) have been developed and deployed by several nations. Present mutual assured destruction "standoff" between these nations is based on surviving counters to QP weapons rather than surviving nuclear weapons.

Bohren, Craig F.: Distinguished Professor of Meteorology, Pennsylvania State University, noted for work in scattering theory. In an experiment **detailed** in C. F. Bohren, "How can a particle absorb more than the light incident on it?" *American Journal of Physics*, 51(4), Apr. 1983, p. 323-327 Bohren shows that in nonlinear conditions a resonant particle may absorb and output 18 times as much energy as is impinging upon it from the usual **field** definitions based on a static intercepting charge. The additional **energy** is "absorbed from the vacuum"; actually, it is absorbed from the nondiverged Heaviside energy flow component accompanying the accounted Poynting input component, but arbitrarily discarded by Lorentz. **The** resonant particle sweeps out a geometrical interception area (reaction cross section) greater than that of the same charge in a fixed static condition. Hence it intercepts part of the always-available Heaviside "dark energy" flow surrounding the Poynting energy flow component of every field/charge interaction.

**Bohren** experiment: Revealing experiment by Craig F. Bohren, replicated by Paul and Fischer, which shows that a given charge when in particle resonance absorbs more energy from a field or potential than the same charge does when in "static" position. This experiment is a direct experimental demonstration of the existence of Heaviside's nondiverged energy flow component around every field/charge interaction. See discussion under Bohren, Craig F. The Bohren experiment can be replicated by any university nonlinear optics laboratory and outputs 18 times as much energy as is input by normal calculations (neglecting the Heaviside nondiverged EM energy flow component of the input).

boson: A particle having integral spin, which obeys Bose-Einstein **statistics** but not the Pauli exclusion principle. Bosons include the photon, alpha-particle, and any nucleus of even mass number.

**bridge**: A component or process which passes EM energy between two **isolated** circuits, but does not pass  $dq/dt$  between them, and which breaks the normal rigidly field-locked power dissipations in the two circuits. Space itself would appear to be one such bridge for EM energy flow.

**bridging function**: The function of passing EM energy flow between two isolated circuits, but not passing  $dq/dt$  between them, while simultaneously

breaking any normal rigidly field-locked power dissipations in the two circuits. Use of the uncurled A-potential where  $\nabla \times \mathbf{A} = \mathbf{0}$  is one available method of bridging otherwise isolated circuits, particularly in the outrigger embodiment of the motionless electromagnetic generator and other COP>1.0 systems.

**broken symmetry:** Fundamentally, a condition in which two parts of some configuration or shape, on opposite sides of some divisor or condition or boundary, are not similar but differ. In vacuum energy physics, we are very interested in the fact that — because of the broken symmetry of opposite charges — any charge (with its associated clustering virtual charges of opposite sign) and any dipole or dipolarity represents an asymmetry in its fierce energy exchange with the vacuum. This implies that something virtual becomes observable; i.e., part of the virtual EM energy continuously absorbed from the vacuum by the charge or by the dipole is changed into observable form and re-emitted as real, observable EM energy. The remainder is re-radiated as virtual EM energy. The charge's transduction of absorbed virtual photon energy and its re-emission as observable photon energy was proposed by the present author in 2000 as the solution to the long-vexing problem of the source charge and its associated fields and potentials (and their energy) reaching across the universe.

**bypass resistor:** In electrical theory, a resistor to pass or conduct current around (in parallel to) some other component. If another effect such as use of the overpotential, pumped phase-conjugate reflection, quantum well, quantum tunneling, negative energy, or charge blocking is added, the bypass resistor's function becomes extremely complicated. The bypass resistor may be complex, e.g., or it may be a true negative resistor in some cases.

**carrier wave:** A fundamental wave that is modulated by another wave or other waves, and hence "carries" the other modulating waveform(s). By stripping off the carrier in a demodulator, the carried waveform(s) emerges.

**Casimir effect:** The attraction of two conducting parallel plates in space, placed very close together, due to their influence on the active vacuum and on the vacuum's interaction with the plates. A part of the vacuum spectrum between the plates is "cut off and blocked or shielded, so that the vacuum potential between the plates is less than the vacuum potential outside them. The resulting potential gradient (force) on each plate from outside pushes the plates together. The Casimir effect unequivocally proves that it is

possible to directly engineer the vacuum so as to produce forces and energy and physical effects in material systems. While it is a "small" white crow, it only takes one white crow to prove that not all crows are black. It is sufficient to conclusively prove that EM energy can be extracted from the vacuum. From there to practical EM power systems, fed by vacuum energy, is simply a product of modifying the prevailing electrodynamics and electrical engineering to incorporate the supersystem components and interactions, and then to gradually discover and develop the necessary technology. In this book we attempt to point the way by using the supersystem and providing some of the major necessary principles and **concepts**.

**Casimir, Hendrik Brugt Bernhard (1909-2000):** Noted scientist who in **1948** correctly predicted that two parallel conducting plates, placed very near each other in a vacuum, would experience an attractive force due to **their** influence on the electromagnetic vacuum.

**causality:** The relationship between "cause" and "effect", or the interaction of 4-space cause upon a previous 3-space observation (effect), to produce a new 3-space observation (change in the previous observable or **production** of an exact 3-space replica). The basic notion in a causal system is that the system's response to an input signal is dependent only **upon** past input values, not upon future input values. In a multiply connected space, the causality principle is dramatically changed and requires very careful accounting.

**chaos:** Indissipative dynamical systems, the dynamical evolution or ordering of the system that is aperiodic and highly dependent upon initial **conditions** of the system. The trajectories of the system move on a *strange attractor*, which is a fractal subspace of the phase space. The mathematical equations describing chaotic behavior are very nonlinear and so complex that at the present time they cannot be computed or predicted. Control of chaotic oscillations thus is ongoing in its scientific development, with the most advanced control work having been done by Russian scientists, but now openly available.

**charge:** *Charge* is the ongoing circulation of EM energy flow between the time and 3-space domains, as "seen" by the observer in 3-space. *Negative charge* is (i) the ongoing absorption, by a mass particle, of EM energy input **from** the time domain (from *ict*), (ii) transduction of the absorbed energy into 3-space EM energy, and (iii) re-emission of the EM energy in all directions in 3-space. *Positive charge* is (i) the ongoing absorption, by a mass **particle, of** EM energy input from 3-space, (ii) transduction of the

absorbed energy into the time domain, and (iii) re-emission of the EM energy in the time domain. Alternately, the positive charge can be considered as (i) the ongoing absorption, by a mass particle, of EM negative energy input from the time domain (from *ict*), (ii) transduction of the absorbed negative energy into 3-space, and (iii) re-emission of the EM negative energy in 3-space. A similar inversion can be utilized to represent negative charge. Time reversal of EM energy can be seen to result from the combined broken symmetries of EM energy flow (in 4-space) between time and 3-space, of two opposite charges and thus of dipolarity itself. See paragraph 3.1 of Chapter 3.

**charge, electrical (q):** In the sense of  $q$  being charged mass, where the mass  $m_q$  of charge  $q$  is associated with the phenomenon defined as charge (see above definition). In our view, an electrical charge  $q$  associated with a charged particle or mass may be defined as  $q \equiv m_q \phi_q$ , to first order. This fits the common use of "the charge" as an expression for a charged mass, and explains why a gathering of charges produces a potential  $\phi$  reaching out from the "source gathering of charge  $q$ ". The actual "charge" action associated with the mass is due totally to  $\phi_q$ , and to the broken symmetry of the  $\phi_q$  dipolarity in the vacuum flux exchange with  $m_q$ . The charge  $q$  can be further broken down into a set of composite dipoles if the gathering of a screen of virtual charges of opposite sign in the vacuum, surrounding the mass of the "bare charge" inside the gathering, is considered. At first order,  $\phi_q$  can be expressed (from *a particle view*) as a change in the local vacuum virtual photon flux (VPF), due to the VPF exchange between vacuum and  $m_q$ . *In a classical approach*, the vacuum may be considered as a giant scalar potential comprised of bidirectional EM wave flows according to Whittaker's 1903 decomposition, except we must re-interpret the phase conjugate half-set of Whittaker's decomposition as incoming from the time domain or complex plane. The charge then may be considered to diverge so much energy flow from the time domain into 3-space "around" the mass, resulting in  $\phi_q$  as the steadily diverged energy surrounding the mass  $m_q$ . The  $\phi_q$  component is actually the massless electrical charge and massless of itself. This approach would then yield a definition of massless charge itself, which at present is undefined in physics, as pointed out by Feynman and others.

In the expression  $q \equiv m_q \phi_q$ , the  $\phi_q$  represents a change to the local vacuum potential  $\phi_{vac}$ . Both  $\phi_q$  and  $\phi_{vac}$  decompose into Whittaker phase conjugate longitudinal EM wavepairs. As can be seen, by altering or engineering these constituent wavepairs, a particular  $\phi_q$  or particular local vacuum potential  $\phi_{vac}$  can be given a deterministic internal structure and dynamics.

Thus the interaction of a given electron or group of electrons may be made **quite** different from the interaction of another electron or group of "apparently identical" electrons. Such structuring dynamics are met with in the internal structuring of water, e.g., where the fierce activity of H-bond making and breaking can be treated as a special  $\phi_H$  and its "internal structure and dynamics" can be engineered. A leading scientist pursuing that type of effect is Jacques Benveniste, in France. Predictably, the **orthodox** establishment has severely castigated these experiments, defending conventional models as absolute while completely ignoring the experimental results that refute those conventional models as being incomplete.

**charge carriers:** Anything — usually fundamental particles, ions, etc. — which consists of or contains charges and can be potentialized and move.

**charge, magnetic:** In the sense of charged mass, a magnetic charge is what is commonly called a "magnetic pole". The mass  $m$  of the magnetic charge is associated with the exchange of EM energy between the time domain and the 3-space domain. Essentially, the energy exchange action **known** as "charge" in the massless sense is the magnetic scalar potential, or monopole, when decomposed as per Whittaker and as reinterpreted by the **present** author, and as pointed out in quantum field theory by Mandl and Shaw. Note that our personal view discriminates between *massless charge and charged mass*. Massless charge is an ongoing action and process, involving energy transduction from one form (time energy or 3-space energy) to another (3-space energy or time energy). A charged mass is a **mass** associated with such action. Unfortunately, in the prevailing usage the word "charge" is just loosely used for both senses without discrimination. Hence one must carefully differentiate between the use of "charge" for "charged mass", and its use for an "ongoing process".

**charge-parity-time (CPT) theorem:** C is *charge conjugation*, which changes the quantum number of every particle into its antiparticle. P is the reflection operation known as *parity*, which turns an object into its mirror image and rotates it 180 degrees about an axis perpendicular to the mirror. T is *time reversal*. Any violation of time-reversal symmetry is always accompanied by a violation of CP symmetry (by violating either C or P symmetry) and vice versa.

Electrodynamics and the strong interaction preserve CP symmetry to great accuracy. Weak interactions do not conserve CP symmetry. T symmetry violation has been shown at CERN, the European particle physics laboratory in Geneva, Switzerland.



**charge trapping (also "pinning"):** Holding charges "pinned" or "trapped" at a site or in a location, by a barrier or force, so that they do not flow as  $i = dq/dt$ . A clustering of the pinned charges at the pinning site often occurs.

**charge-barrier:** A process or component or function — particularly in a semiconductor such as the Fogal semiconductor — that blocks the movement of charges  $q$  as current  $dq/dt$ .

**classical electromagnetic theory:** The classical theory of electrodynamics, in its modern form begun by Maxwell with his seminal-paper orally presented in 1864 and published in 1865. Today many variations have been made, particularly with respect to the basic group symmetry of the theoretical equations.

**Clifford algebra:** A special higher topology algebra founded by Clifford, which includes as subsets many other algebras of lower topology.

**closed system:** In the present approach, a system that in theory does not communicate with its environment, and does not exchange energy or matter between system and environment. Notice that this directly conflicts with the notion in thermodynamics (both classical and disequilibrium) that a closed system is closed only to mass exchange across its boundary, but open to energy exchange across it. General relativity has falsified that notion since 1915. Any system undergoing a change of energy also undergoes a change of mass, since mass is a special form of energy.

An ideal model in which dynamically and energetically the system is considered to be "isolated" as if nothing else existed. In short, the system is considered as if it were in some "magic box" and nothing outside the box can ever enter the box or affect the system inside the box, and nothing in the system can ever leave the box or affect anything outside the box. No electromagnetic system is closed. In short, we have corrected the thermodynamics "closed system" with open energy transfer, to a true closed system with neither energy nor mass transferring. That corresponds to the present thermodynamics notion of the "isolated system".

One performs a non sequitur when proclaiming treatment of any EM system as a "closed system", and of course modern physics substantiates this. The broken symmetry of the opposite charges on the ends of a dipole — and of an observable charge together with its clustered virtual charges of opposite sign — has been proven since 1957. The absence of any closed system is particularly true in electrical power systems. Here one is indeed allowed to input energy into the system to excite or potentialize it. That **of**

course assumes that the system was "opened" long enough to take on excess energy (which also changed its mass)! Then as the system operates, losses and dissipations occur, in which case energy is considered to "escape" from the system permanently. In other words, the system was also continually "opened" so that energy could escape. In any EM system, every charge and dipole is already an open system, with free exchange of energy between 3-space and the time domain via that charge. In particle physics, every charge and dipole is a broken symmetry in its virtual particle flux exchange with the active vacuum.

The ancient thermodynamics definition of a "closed system" as one that exchanged heat but not mass, was formulated before thermodynamicists even knew that heat was a form of EM energy, or even knew what energy was. Hence we have changed that definition, since it is a non sequitur in view of modern physics.

There is really no such thing as a truly closed system in the universe, since every system is embedded in the active vacuum and is an open system in an energy exchange with the vacuum. Further, any change of energy in the system curves the local spacetime, which in turn interacts back upon the system. If that energetic exchange of the system with its "active vacuum and active curved spacetime environment" is symmetrical, then the system is in equilibrium with respect to its environmental exchange. In that case, for a limited number of purposes the system may be treated as if it were a closed system. In classical electrodynamics, Lorentz regauging of the Maxwell-Heaviside equations further reduced them to describe only Maxwellian systems in equilibrium with the active environment including the active vacuum. Consequently, any *net* interaction between the external vacuum (or the active local curved spacetime) and the system was excluded from the CED model. Obviously a *broken equilibrium* (i.e., broken symmetry) in that actual physical interaction is also not included in the CED model. Nor is it included in the classical (equilibrium) thermodynamics model with its archaic second law.

coefficient of performance (COP): Ratio of the usable energy output of a system divided by that portion of the total energy input that is input by the the operator's or experimenter. The COP is thus a measure of "return for using the operator's or experimenter's input energy" to produce — or direct the production of — useful work by the system". There are other ways to calculate the COP ratio; e.g., the average output power divided by the average operator input power. Contrast COP to the *efficiency* of a system, which is the ratio of the total usable output energy divided by the *total input energy from all sources*, including by the external active

environment as well as by the operator. The efficiency of a system means how efficiently it produces useful output from its *total* input. The COP is the performance the system renders for the *operator's* input. Note that even a highly inefficient system — say, with efficiency  $\xi = 0.25$  — may nonetheless have a  $\text{COP} > 1.0$ , if the operator himself inputs less energy than the system outputs and the environment inputs all the rest of the output energy as well as all the energy in the system losses. As an example, a common home heat pump may have an efficiency of 40%, but a  $\text{COP} = 4.0$ . A windmill may have an efficiency of 20%, but a  $\text{COP} = \infty$ .

Also, for many systems one may evaluate their coefficient of performance for (1) the performance of the system as an energy transducer only, i.e., the ratio of energy the system outputs (whether used or not) divided by the energy the operator inputs; or (2) the performance of the system as a work producer, which is the useful work accomplished by the system divided by the operator's energy input. As an *energy transducer*, every generator and every battery has a  $\text{COP} \gg 1.0$ , when both the Poynting diverged energy flow output and the Heaviside nondiverged energy flow output are accounted. Yet for useful work, the same system may have  $\text{COP} < 1.0$ , because all the Heaviside nondiverged energy flow component is wasted, and some of the Poynting diverged energy flow component is wasted also.

Analyzed as an energy transducer only, every dipolar power unit — such as a generator or battery — outputs enormously more energy flow rate from its terminals than the mechanical energy rate input to the shaft of the generator, and than the chemical energy dissipated in the battery. So as an energy transducer, every dipolar power source is already a system exhibiting  $\text{COP} \gg 1.0$ , prior to Lorentz' integration trick to discard the enormous Heaviside nondiverged energy flow output component.

**cold fusion:** An ad hoc term applied to the transmutations at low spatial energy (but high time-energy) achieved in electrolyte experiments, particularly when using specially prepared palladium electrodes after their loading with positive  $\text{H}^+$  or  $\text{D}^+$  ions, and particularly when deuterium is present in the electrolyte and the loading is by  $\text{D}^+$  ions. The *total* energy of the photon is greater the lower the photon's frequency and therefore the lower the spatial energy of the photon. Hence the cold fusion interactions actually use much higher *total* energy nuclear reactions than does present high (spatial) energy physics. Since "high energy" physics erroneously eliminates consideration of time-energy, the present high energy physics community is unjustifiably hostile to the very notion of cold fusion. The fact that little experiments on the lab bench use far higher total energy than the community's proud large accelerators is a bitter pill many high energy

physicists cannot *tolerate*, let alone view with scientific objectivity. So **again** there is a classic confrontation between science from scientific results and "science as known in the prevailing dogma".

composite dipole: Dipole formed as one part of an isolated, observable "charged particle", consisting of a differential element of that observable charge on one end and a momentary clustering virtual charge of opposite sign. This is one way of dealing with the modern "infinitely strong dual **dipoles**" view of the charge, where the bare charge in the middle is infinite as is the clustering virtual particle charge surrounding that bare charge and **partially** shielding it. The difference between these two infinite charges is **finite**, and is routinely calculated to show that it is the standard value of the charge as seen by an external observer.

**C ooper pair:** In superconductivity theory, a dynamic, weakly bound **pairing** of electrons in a superconducting material below its critical temperature. In this pair, if the energy state with wave number  $\sigma$  and spin  $1/2$  is occupied by an electron, then so is the state with wave number  $-\sigma$  and spin  $-1/2$ . The Bardeen, Cooper, Schrieffer (BCS) theory uses this concept to provide a detailed microscopic theory of superconductivity.

COP (Coefficient of Performance): See coefficient of performance.

**cosmological feedback principle:** A self-regenerating cosmological **feedback** cycle ascribed by Puthoff as the source of the vacuum EM zero-point energy (ZPE). One may assume the existence of EM zero-point energy by fiat as part of the boundary conditions of the universe, or conceive of its generation by the quantum-fluctuation motion of charged particles that constitute matter. Puthoff calculated the latter possibility, **assuming** that the ZPE spectrum (field distribution) drives particle motion, **and** that the particle motion in turn generates the ZPE spectrum. This provides a self-regenerating cosmological feedback cycle, which in fact is consistent with the general relativity assumption that curvature of spacetime affects mass energy, and mass energy changes affect the **curvature** of spacetime. It would be interesting to see if Puthoff's concept can be made compatible with the broken symmetry of a dipolarity and Kron's open path concept.

**curl concept of fields:** The concept of a field as the curl of a vector **potential** (the vector potential may not be known). Any field so conceived has a divergence of zero *a priori*. One must be careful, however, because electrostatics calculates only the field's reaction cross section with an *assumed* fixed unit point static charge at a point in space, leaving the field itself undefined. In short, the calculation of "the field" is actually a

representation of the local point intensity of the field's interaction with unit point static charge. It is not the magnitude of the entire field (or potential) itself, *a priori*, but only of its reaction at a point with such a charge. In short, the field's reaction cross section with static charge is often misinterpreted as the magnitude of the field; at best it is an indication of the field intensity to static charge at a point.

**curl-free magnetic vector potential:** A field-free magnetic vector potential  $A$  without curl (swirl), hence lacing the  $B$ -field with which an  $A$ -potential is usually associated. For simplicity, one may visualize the curl-free  $A$ -potential as massless magnetic charge (and energy) in linear motion. Toroids and long solenoids have the characteristic of confining the  $B$ -field (curled potential) and holding it inside. However, drawing energy from any potential whose source charge or source dipole is not destroyed simply results in the full value (sum of the  $A$ -potential and  $B$ -field components) of the potential being replenished from the active vacuum, via the 4-symmetry energy flow mechanism in the presence of the broken 3-symmetry of the dipole. Hence one may easily increase the available potential energy density at will. This is a special form of gauge freedom allowing one to freely alter the potential energy of any electromagnetic system at will. Contrary to the dictates of EM textbooks, gauge freedom rigorously allows the direct and *free* amplification of potential energy of the EM system *at will*; the excess energy being freely furnished from the active vacuum processes. This principle incorporated in gauge field theory, has been known for decades and not previously used in the design, production, and use of COP>1.0 electrical power systems, prior to the invention of the motionless electromagnetic generator (MEG).

**curved spacetime:** A four-dimensional geometry (spacetime or ST) is used in general relativity, where the ST curvature is determined by the distribution of spatial energy such as mass-energy. In the general relativity view there is no such thing as an "empty" space "filled" with some energy substance. Instead, there is a combined space and time as a single entity, *spacetime*, which is itself energetic and is the very geometry we use in our mathematics. Any change in the local energy density of that spacetime constitutes a *curvature* of spacetime. In the new, more extended approach, any change in the spatial energy density or time-energy density of spacetime, or a combination of changes in both, constitutes a curvature of spacetime. In 4-space modeling, time is treated as a special, highly condensed form of EM energy. Specifically time may be regarded as ordinary 3-spatial EM energy compressed by a factor of  $c^2$  and existing in

the time domain rather than in 3-space. Time-energy therefore has essentially the same energy density as mass.

dark energy (negative): (Dirac holes, Dirac hole potentials, Dirac hole currents): A strange form of vacuum energy that creates repulsive gravity, causing the expansion of the universe to speed up (as observed and not otherwise explained by conventional theory). As a strong candidate for the dark energy, the present author has proposed a vacuum negative energy and negative energy currents in a negatively curved spacetime region partially containing excess Dirac sea holes devoid of electrons, along with normal filled Dirac sea holes. These special "Dirac negative action quanta" then form *negative action* (negative angular momentum, or — for simplicity — negative energy) potentials, currents, and fields. This type of vacuum condition containing some empty Dirac sea holes is referred to as a Dirac *-polarized vacuum*. However, it is not just simple static

polarization, but possesses rich dynamics. Such dynamic Dirac sea hole regions occur in the vacuum in curved spacetime regions with tempic potential gradients and strong 3-spatial energy gradients, and thus time force existing across the region. The holes occur since the energetic fluctuations of the local vacuum energy can separate a Dirac hole from its occupying electron. These may then recombine, or in sufficient local spacetime curvature can remain apart. The more violent the region, the more severe are local spacetime curvatures in that region, and the greater the fraction of empty Dirac holes that is maintained on the average, in their continual forming and recombining. In those regions, a tempic potential is higher at the higher center magnitude of the spatial energy density. Hence there tempic forces from "inside to outside", providing a "tempic broom" effect to sweep outward the excess Dirac sea holes separated from their electrons in the curved spacetime. The end result is the presence of increasingly unoccupied Dirac sea holes toward the outside of violent regions of spacetime, until the effect is overcome by the decreasing spacetime curvature. These empty Dirac holes in regions and currents are a special form of vacuum negative energy, negative energy fields, and negative energy potentials, creating negative gravity (repulsive gravity) upon ordinary mass exposed to them. So the more distant violent astronomical regions have greater amounts of repulsive gravity being produced by their local Dirac-polarized vacua and negative energy fields and potentials. The result of this effect is that, at sufficient distance from us, the increasingly earlier, more violent events and resulting greater curved spacetime regions have created sufficient Dirac-polarized vacua to overcome the normal gravitational attraction between galaxies, etc. Even farther out, the increase in Dirac-polarized vacua overrides the normal

attractive gravity between galaxies, etc. and produces net repulsive gravity. In turn this results in acceleration of the observed distant expansion of the universe. Dirac-polarized vacuum and its special dynamics can be accommodated in Sachs' unified field theory, which unites physics from quarks to the cosmos. See also **Dirac sea holes**.

On the laboratory bench, Dirac hole currents and effects are met with in a circuit or system producing  $COP > 1.0$ , or very sharp 3-spatial gradients such as in violent electrical discharges. The effects become non-negligible at about  $COP = 2.0$  and sometimes less. The tempic force back across the, system from output to input is sweeping the Dirac holes through the system. This can play havoc with attempts to close-loop the circuit for self-operation. In semiconductor components, strange effects are met due to their use of donor and acceptor materials, and temporary or permanent failure of semiconductors can result. The simple way to visualize this is that, in the system's supersystem, the spacetime component is curved and the vacuum component is highly nonlinear. All three components — overunity system, local nonlinear and polarized vacuum, and local curved spacetime — are interacting vigorously with each other. An operating overunity system represents an excited state of that local region of vacuum and curved spacetime, hidden in the euphemism "polarized" which is inadequate to describe the dynamics. With the dynamics, one may visualize that the Dirac sea hole currents are swept back through the system, seeking to recombine with electrons to eliminate the "polarization" and its dynamics, thus decaying the excited state back to equilibrium and destroying the overunity condition. In a robust system whose internal parts do not appreciably interact with these Dirac hold dynamics, the dynamics will reach the input section and extend back into or toward the primary power supply. In the input section, the feeder line, and in the power source itself, this results in "eating electrons". The Dirac sea effects thus act as a separate load imposed within and around the system input section or even back in the feeder line to the external power supply, in addition to the system load itself in the system output section. Simply put, the power supply must now furnish extra electrons to "power" the Dirac sea hole recombinations first, and additional electrons to power the system in its "normal" fashion. The result is to "draw additional power" from the source, where "drawing power" now includes the additional "eating of electrons" within the power supply itself, the feeder line, and the input section of the system.

Bedini and Bearden have filed a patent application on processes to convert the detrimental Dirac sea hole current reaching the system's input section.

transforming it into ordinary electron current. Magnetic Energy Ltd. has developed two other processes that handle the Dirac sea hole current problem, allowing close-looping for self-powering operation. One of these processes converts negative energy into positive energy and the other avoids the negative energy problem. The first one allows this otherwise devastating special form of "negative feedback" or "degenerative feedback" to be converted into "positive feedback" or "regenerative feedback", allowing the system to be close-looped successfully for self-powering. Bearden has proposed yet a different approach using an "anti-circuit" method, but at this writing the method is still proprietary until intellectual property rights are secured.

**dark energy** (positive): Our term for the vast Heaviside nondiverged energy flow components surrounding every field/charge and potential/charge reaction but unaccounted in present electromagnetic theory after being arbitrarily discarded by Lorentz circa the 1890s. Present theory only accounts for that small amount of energy flow (the Poynting component) diverted locally around the interacting charge. All the rest of the energy flow comprising the field or potential, and missing the intercepting point charge, was discarded arbitrarily by Lorentz and is still discarded today, using Lorentz's integration trick. In honor of Heaviside, who **did** recognize the gravitational implications of his dark energy flow component, the present author has nominated this vast, unaccounted "dark energy" component as being responsible for the extra gravity holding the spiral arms of the spiral galaxies together. See **spiral galaxy**.

So one must recognize that the term "dark energy" is indefinite, since there are two kinds: (a) dark positive energy, and (b) dark negative energy. Dark positive energy consists of "normal" energy as often connected with particles, collected upon them and affecting their momenta, etc. It has dynamics and effects consistent with that kind of energy. Dark negative energy is a condition of the vacuum itself. It represents a sort of "empty container and empty container dynamics" (negative energy dynamics) in the vacuum itself, which "eats positive energy", so to speak. In **philosophical** terms, dark positive energy represents unaccounted actions and effects from unaccounted "extra presence of real substance and things and actions". Dark negative energy represents unaccounted actions and effects from "extra absence of real substance and things and actions beyond zero". Dark negative energy exhibits precisely opposite effects to the **effects** produced by dark positive energy. E.g., dark energy creates the excess *gravity* that is holding the arms of the spiral galaxies together. Negative energy resulting from spacetime curvature conditions in highly



energetic astronomical phenomena produces the *antigravity* that is responsible for the acceleration of the expansion of the universe. We have nominated the negative energy Dirac sea hole phenomena as the cause of the antigravity that accelerates the expanding universe. Interestingly, these negative energy phenomena present in sharp discharge (strong gradient) phenomena appear to be responsible for the fact that such phenomena are known to violate present thermodynamics, and are being studied under the aegis of "extended thermodynamics". See discussion of areas violating thermodynamics in the last chapter of Kondepudi and Prigogine, *Modern Thermodynamics: From Heat Engines to Dissipative Structures*, Wiley, New York, 1998, reprinted with corrections in 1999. A reference is D. Jou, *Extended Irreversible Thermodynamics*, Springer-Verlag, New York, 1996.

**degenerate semiconductor:** A semiconductor whose conductivity approaches that of a metal.

**demodulation:** From a carrier containing a modulated signal, recovering the signal that was used to modulate it.

**deterministic pattern or "template":** The exact arrangement, by plan and deterministic action, of a group of entities. The deterministic actions and their "controlling forces" are simply called "dynamics", "structuring", etc. An example might be deterministic field structuring and actions of photons in a "herd" or "group". Or of a set of spacetime curvatures, into a dynamic structure called a *spacetime curvature engine* — or *engine* for short, so long as the meaning is clear. Or by hidden order in the virtual photons in the vacuum flux, or a deterministic set of changes to that vacuum flux (the vacuum flux that is called the "vacuum potential." We have called this *internal EM dynamics* function — of deterministically patterning or templating the virtual flux (particle view) of the potential, or of deterministically patterning or templating the longitudinal and time-polarized EM wave decomposition (wave view) of the potential - *dimensioning* the potential. See **dimensioning**. We refer to the deterministic structure and its structural dynamics as the "engine template".

**dielectric:** Literally, "against electric (current)", originally coined to mean "opposes the flow or conduction of electric fluid". In today's language, a dielectric is a non-conducting material used to oppose or prevent the flow of electric charges. Even empty vacuum exhibits some dielectric resistance. "Dielectric" is also used to refer to a nonconducting material (often between the metal plates of a capacitor or elsewhere) that can (i)

sustain a change in potential across a distance (i.e., an E-field), and (ii) serve as an insulator. Space itself is a dielectric, or at least is said to exhibit certain dielectric qualities.

dimension: A certain primary geometrical physical attribute, such as length, used to describe the separational relationships of physical phenomena. Actually, "dimension" just means "fundamental quantity of separation" and "geometry" in the most general sense. Dimensions thus become a sort of set of fundamental variables describing the *extensivity* of system and the dynamics of that extensivity. The number of dimensions taken in advanced physics usually represents a somewhat arbitrary choice for good modeling fit. In modern Kaluza-Klein theory, for example, it becomes necessary to accept some 10 or 11 dimensions in the usual particle physics case. Sometimes more than 20, or even an infinite number, of dimensions may be used. General relativity (GR) has incorporated the interaction of the abstract geometry (spacetime) with mass, so that *geometry is a real, active, dynamic entity*. Until Sachs' extension of Einstein's work into a unified field theory and Evans' incorporation of O(3) electrodynamics as an important subset of Sachs' unified theory, GR has largely remained an nonexperimental discipline, at least in the laboratory. With the new Sachs-Evans approach and with recovery of (a) the Heaviside dark energy flow component (b) over unity EM systems arbitrarily discarded by Lorentz symmetrical regauging, and (c) modeling of the complete supersystem including system, vacuum, and spacetime in mutual interaction, GR suddenly becomes substantially engineerable by novel electromagnetic means, both in the laboratory and in operating devices. We are thus entering a great new age of electrogravitation and a new physics. Research in antigravity lifters, COP > 1.0 electrical power systems, medical therapy utilizing engines and anti-engines, and cold fusion are the elements of the new science that are struggling to be born and funded.

**dimensioning:** Coined term meaning "forming an exact pattern or template of structures", particularly of nested curvatures of spacetime, where the pattern/template may also be dynamic, to include patterning and dynamics in the time-energy domain as well as the 3-space energy domain. It involves the internal structuring of the "dimensioned" entity. The term "dimensioning" makes sense in unified field theory, but is awkward in normal EM theory, which erroneously assumes that EM energy propagates in an uncurved spacetime. The mere presence of a change in local spatial energy, created by the wave energy itself when present in that local region, curves the local spacetime. Note that the background potential may be

changed in a steady state level as well, which means that the frame of the system and its field dynamics has been rotated away from the laboratory frame. A time-polarized EM wave, e.g., changes the time-energy density and also curves local spacetime very powerfully. Hence the EM wave rigorously travels in curved spacetime, and in fact identically is a propagating, oscillating curvature of spacetime. What is missing from present physics is all accounting of the extraordinary Heaviside nondiverged energy flow component accompanying the accounted Poynting diverged energy flow component. Thus present physics *does not properly account for* the gravitational aspects of "electrodynamic field and potential energy in space".

Dimensioning also implies a deliberate form or structure (with dynamics) created in the virtual photon flux of the vacuum, in the virtual photon flux comprising a scalar potential, or in the infolded longitudinal-wave EM inside all EM potentials, fields, and waves. It implies an associated set of spacetime curvatures and their dynamics. The latter are referred to as "engines", "vacuum engines", "spacetime curvature engines", etc.

Dimensioning the potentials or signals or carrier waves of conventional electrodynamics involves adding hidden *vacuum engines* to them. The term *dimensioning* is descriptive and was chosen because adding such templates is equivalent to increasing the EM topology by adding mathematical dimensions. Since an EM wave or field or vector potential can be decomposed into two scalar potentials, then "dimensioning" one or both of the scalar potentials can "infol" the desired hidden structures or patterns (vacuum engines) inside an EM carrier wave, EM field, or vector potential created by the interference of the two dimensioned base potentials. This is referred to as *dimensioning* those EM field and wave entities. Internally structuring the two scalar potentials via arrays of longitudinal EM wave emitters and applying the necessary dynamics (modulations), is the primary manner to directly engineer dimensioning. When dimensioning is present, two EM waves that appear identical as seen on the oscilloscope may have dramatically differing internal structures (dimensioning). Hence they may produce drastically differing effects when they interact with the same or similar objects. *The only way in which the action of a vacuum engine can be resisted is to create and simultaneously introduce the exact antiengine for it — a special sort of forcible symmetrical regauging, so to speak.* Once the action has been completed in the receiving object and it has been physically changed, the only way it usually can be undone is to form a precise antiengine for that action, amplify the antiengine, and let the antiengine act upon the object for a

sufficient time to "time-reverse it back to its previous physical state and condition". The concept has great utility in electromagnetic healing, not discussed in this book. We point out that the decades-long induction of diseases, health changes, etc. in U.S. personnel in the U.S. Embassy in Moscow occurred in forcefield-free regions. In short, the changes occurred in regions where the potentials were stable and unchanging, and so their **engines** were stable and constantly applied to the exposed personnel. The Soviets were simply radiating a high level target, the U.S. Ambassador and his **staff**, to guarantee high-level U.S. attention. By U.S. reaction to the **deliberate** electromagnetic "engine" induction of disease and health **changes** (three Ambassadors sickened and later died), the Soviets could **positively** ascertain whether we knew of the "infolding" or "dimensioning" technology, and whether we had developed defenses.

**dipole:** In the simplest case, two separated charges of usually equal magnitude and of opposite sign. More generally, a localized positive charge or charge distribution, and a localized negative charge or charge distribution, such that the net charge summation is zero, while the positive and **negative** charge distributions do not precisely superpose point to point but only on the average. We point out, however, that in regular physics electrical *charge* has no proper definition. As is well known in particle physics, due to the opposite charges on its end a dipole is a broken **symmetry** in the virtual photon flux of the vacuum. By definition of broken symmetry, this means that *some* of the virtual energy flux continuously **absorbed** from the seething vacuum by the charges of the dipole is not re-radiated as *virtual* energy. Instead, it is integrated *coherently* and re-radiated in 3-space as real emitted EM energy, establishing the fields and **potentials** associated with that source charge or source dipole. The dipole is **therefore** the most fundamental true "negative resistor" since it freely and continuously receives EM energy in unusable form, transduces it into usable form, and re-emits it in usable EM form.

It follows that any positive charge in the universe and any negative charge in the universe form a dipole and a broken symmetry in the vacuum flux. Hence every such dipolarity in the universe already extracts energy from the vacuum and puts it out in 3-space, or absorbs energy from 3-space and returns it to the vacuum. Kron called this an "open path" electrically, well

before broken symmetry was formally discovered and experimentally prove in 1957. Kron was also able to use the open path in and around special electromagnetic circuits to cause the circuits to become true negative resistors, freely powering the network analyzer at Stanford University even in the 1930s.

In classical EM theory, the problem of how every charge and dipole can continuously emit EM energy to form all the associated fields and potentials and their energy has been an unsolved problem — sometimes called the most difficult problem in electrodynamics, both classical and quantal. For the solution and a discussion, see the present author's paper "Giant Negentropy from the Common Dipole," *Journal of New Energy*, 5(1), Summer 2000, p. 11-23. Symmetry represents a conservation law, and broken symmetry represents violation of that conservation law. Because of the broken 3-symmetry of the dipole, the EM energy flow is not conserved in three dimensions — in this case, violation of conservation of 3-space EM energy flow is not conserved. Neither is the time EM energy flow conserved in the 4th dimension. Instead, EM energy flow is conserved in 4-dimensions, between the inflow in the time-domain and the outflow in 3-space in all directions, or vice versa. The hidden inflow of EM energy to the dipole (and to a charge) is actually from the complex plane (time domain). Thus all EM energy in 3-space is actually received by the source charge or source dipole from the time-domain, and returned to the time domain. What we call "propagation of EM energy through 3-space" is actually the spreading of this 4-circulation to successive 3-space points. The importance of the internal structuring of time-flow and of longitudinal EM waves in the time domain (dimensioning in the time-domain) is apparent, since it produces very powerful engines that can act upon matter in any fashion desired. Indeed, the Russians have developed clandestine robot engine systems comprised of sets of spacetime curvatures and their dynamics (which are just sets of longitudinal EM waves and their dynamics). Any function of a weapon system — sensing, weapons (using scalar interferometry), communications, propagation, etc. — can be incorporated. The capabilities of such systems, such as travel through continuously emitted EM signal beams from satellites, communications stations, power lines, etc., is eerie. Such a system can reside in any convenient EM potential or field as a "dimensioning" of the potential or field. Such robot engine systems have been clandestinely tested, but discussion of them is beyond the scope of this book. Suffice it to say that these systems are ushering in a dramatic revolution in future warfare, and the present research in physical nanobots is already decades behind.

Very powerful support for the author's solution of the source-charge problem is given by F. Mandl and G. Shaw, *Quantum Field Theory*, Wiley, 1984, Revised edition 1993, under the heading "Covariant Quantization of the Photon Propagator" in Chapter 5. In their deeper coverage of the photon polarizations, Mandl and Shaw point out that the longitudinal and

scalar polarizations are not directly observable, but only in combination, where they manifest as the "instantaneous" Coulomb (i.e., electrostatic) potential.

Translated from particle terminology to wave terminology, Mandl's and Shaw's argument directly fits my re-interpretation of Whittaker's 1903 decomposition of the scalar potential.

**Dirac**, Paul A. M.: Noted English physicist, 1902-1984, who shared the Nobel Prize for developing wave mechanics and predicting the existence of the positron. He also originated the notion of "holes" or negative energy **states** in the vacuum, where the holes are ordinarily filled with electrons. The "vacuum replete with these Dirac structures" (all filled with electrons) is referred to as the *Dirac Sea*. If some of the holes are empty, then that is **the** Dirac sea of a curved spacetime. We strongly stress that a Dirac sea **hole** (negative energy electron with negative charge, negative energy EM fields and potentials, and with negative mass-energy) prior to observation (prior to its reaction with mass) is a quite different entity from the positron (after reaction with mass, so that the positron has positive mass-energy, **positive** charge, positive energy EM fields and potentials, and has been reversed in its 3-space propagation direction). Specifically, the Dirac sea **hole** produces negative energy fields and potentials, whose powerful Heaviside nondiverged components enable to perform practical antigravity. The (observed) positron produces gravity, not antigravity, and also positive energy fields and potentials.

**Dirac sea**: A concept and description (modeling) of the vacuum as containing — amongst other things — a "sea" of an infinite set of negative energy slates ("holes") for electrons, almost all of which are usually filled with electrons in the absence of any spacetime curvature of significance. In Dirac electron theory, the relativistic wave equation for the electron has four components, which correspond to two spin orientations and two energy conditions: positive and negative. Ordinary electrons are in the positive energy condition. So then the vacuum must also possess a "sea" of negative electron energy conditions. These negative conditions are called "holes" and are ordinarily filled or mostly filled with electrons which have fallen into these negative energy states. The Dirac sea is this vacuum sea of negative energy electrons (and a perhaps a few empty holes). In forward time, if energy is added to a negative energy electron, electrons can be **lifted** from this sea, since the added energy creates a local curvature of spacetime. If spacetime is locally curved, additional holes may be created so that, when the holes meet normal positive energy electrons, the electrons fall in and disappear, creating the appearance of an "electrical

energy sink." This can happen so that the local ST curvature merely relaxes back to an uncurved spacetime, therefore avoiding radiation from "pair annihilation". If the curvature is in the opposite direction (i.e., if positive energy is added to the vacuum), electrons may be lifted from the Dirac sea by the resulting spacetime curvature energy, thus producing a flow of electrons "right out of the nonlinear vacuum" and generated by the spacetime curvature, and creating the appearance of an "electrical energy source" from the vacuum itself. In that case the energetic holes left behind also remain, and are affected by all EM fields etc. These holes thus form negative energy currents, fields, potentials, waves, and other electromagnetic entities such as negative energy charging and discharging (excitation and de-excitation).

In an overunity EM system, there is a higher energy density in the output section than in the input section. This includes time-energy density. So a higher tempic potential exists at the output than at the input. A gradient in the tempic potential thus exists, which constitutes a tempic force from the output section back through the system to its input section, and even on back through the conductors to the external power source, and even back into the distant external power source itself. Thus the power source has to furnish additional electron current. It must "power the holes", so to speak, by furnishing the electrons that are "eaten" by the Dirac hole current to eliminate it, which represents a novel kind of load in the input section of the system. So the power supply must furnish more power, so as to furnish the normal power to power the system, and the extra power to "power the elimination of the Dirac sea hole current as a back-reflected load". This is nature's way of decaying the excited state represented by  $COP > 1.0$ , and restoring equilibrium and  $COP < 1.0$ . By the Bedini process, the otherwise detrimental Dirac sea hole current reaching the input section is transformed into ordinary electron current, thus serving as input power to the system. By adjusting the system and optimizing it, this strange kind of "positive power input from converted Dirac hole current negative power feedback" can be adjusted to equal the input power required by the system. At that point the external power system can be disconnected, and the unit continues in close-looped and self-powering operation, including powering its load as well. Gabriel Kron succinctly described this condition and adjusting for it. Such a system allows energy to be continuously extracted from the vacuum, and a load to be powered continuously, with all the energy to run the extracting system being freely received from the active vacuum.

Dirac sea hole: A negative energy state for an electron, in the Dirac theory (in the Dirac sea). Literally the hole (negative energy state) when not occupied by the electron. In flat spacetime, almost all Dirac sea holes are filled with electrons. A small fraction on the average are not filled due to the local fluctuations of the vacuum energy continually lifting electrons from their holes and then having them recombine, usually so quickly that no radiation occurs in the observable state. The situation in the virtual state can be described by Feynman diagrams. This received view can be falsified in a curved spacetime. There the holes can exist and flow as currents, as validly as positive energy electrons can flow as currents, without the incessant "filling" activity of the vacuum itself. In addition, in such a hole-stabilizing curved spacetime region, the hole can "eat" or recombine with a real electron, so that the electron vanishes but without radiation. If we wish to join the two views, then we take Feynman's and Wheeler's view that the field does not exist in vacuum as such, but only the potential for it exists — in short, only the engine exists. The engine can then be said to be an ordering (chaotic self-ordering) condition present on the statistical random variation of the fluctuations of the vacuum. With longitudinal EM wave technology, this "order in the midst of disorder" — this templating and engine technology — can be directly engineered.

Dirac sea hole current (positron current): Just as a current of positive energy electrons can be generated, a current of negative energy Dirac sea holes can also be generated if the local spacetime is properly curved. Mathematically these are usually considered to be "positron currents", except they have no positive mass, because a hole will "eat" an electron. In an overunity electrical power system, the tempic potential is greater at the output of the system than is the tempic potential at the input section. There thus exists a "tempic force" or "tempic broom" sweeping Dirac sea hole current (positron current) out of the input section of the system into the external power supply. Simple instruments will record this current as if it were electron current being furnished from the external power supply to the system. Also, the Dirac sea positron current will "charge" the battery with Dirac sea holes (mathematical positrons), which in the conventional sense discharges the battery. A battery may become highly charged with Dirac sea holes. If so, then when placed on a normal battery charger, the electrons in the charging current will be "eaten" for an extended period by falling into the Dirac sea holes, and the battery will not acquire any charge until they are filled — whereupon the battery will suddenly begin charging up normally again.



We also point out that the vacuum, containing the Dirac sea, actually is not "massless" at all, but has zero resultant mass on the average, as a result of the simultaneously presence of positive and negative mass in average equal abundance. Any curvature of spacetime must violate this "net sum zero" mass, hence produces inertia in all masses. Note that a negative mass can also exhibit a negative inertia; i.e., it accelerates and enhances the action of any force acting upon it, instead of opposing it. In short, negative mass exhibits negative inertia. We suggest that this effect is probably involved in the more violent explosive phenomena of astrophysics.

**disequilibrium:** Broken equilibrium, which in turn involves breaking appropriate conservation laws unless compensated.

**displacement current:** The apparent continuation of a conduction current through a region of space without a conductor, e.g., between the plates of a capacitor. Rather than being the motion of charges in a conductor, the displacement current is related to the rate of change of an E-field, and thus to the rate of change of the strain of the dielectric.

**dissipative structure:** In open systems far from thermodynamic equilibrium, a region of self-ordered behavior of a special kind in matter, characterized by symmetry-breaking, multiple choices, and correlations of macroscopic range. By correlations we mean statistically reproducible relations between distant parts of the system. Formation of a dissipative structure represents the birth of complexity in that region by self-organization. Usually a dissipative structure emerges only after the driving constraints reach a critical value. As the embryonic "engine" technology advances, however, the direct engineering and control of dissipative structures will become commonplace and routine.

**distortion correction theorem:** "If a scalar wave  $E_1(r)$  propagates from left to right through an arbitrary but lossless dielectric medium, and if we generate in some region of space [say near  $z = 0$ ] its phase conjugate replica  $E_2(r)$ , then  $E_2$  will propagate backward from right to left through the dielectric medium, remaining everywhere the phase conjugate of  $E_1$ ." Quoted from Amnon Yariv, *Optical Electronics*, 3rd Edn., Holt, Rinehart and Winston, New York, 1985, p. 500-501.

What is missing from the distortion correction theorem is hidden in the phrase "*if we generate in some region of space ... its phase conjugate replica*". Since electrodynamicists and optical physicists have been unaware that all EM energy at any point in space comes from the time domain to that point, then —*prior to detection by interaction with charge*— the actual phase conjugate wave exists in the imaginary plane (in the

time domain) and *not* in 3-space. The continuous interaction of that imaginary plane wave with charges, to actually produce the force-field wave in space, is *assumed* in the standard nonlinear optics. In short, one is looking at the "effect" wave, not the "cause" wave. However, since time is not an observable even in theory, it is this "effect" wave in 3-space that will indeed be measured by our instruments, because they must interact the imaginary or phase conjugate field with charge in order to detect or observe it (measure it).

The proof of this is experimentally already known but not recognized. If one reflects an EM wave off a normal mirror, the mirror must absorb the incoming wave, which transfers the wave momentum to the mirror to repel it, then the mirror must re-emit it, which adds that much more momentum to the recoil. So the mirror recoils with twice the momentum of the reflected wave. That produces a wave going in the other direction. If the incoming wave is continuous, one then has "paired" waves going in **opposite** directions). However, if an incoming wave strikes a phase conjugate mirror (PCM) material and is phase conjugated, a wave going in the opposite direction also emerges, but it synchronizes point by point with every spatial point occupied by the incoming wave. Also, *the phase conjugate mirror does not recoil at all*. This is well known in phase conjugate optics. It clearly shows that the origin of the "detected" phase conjugate wave is quite different from that of a normal reflected wave.

Indeed, by our reinterpretation of Whittaker's 1903 biwave decomposition of the scalar potential, at every point along the detected phase conjugate wave, the energy enters that point from the time domain, and not from some sort of reflection from the PCM. The energy also returns to the time domain from that point. Its presence at the point produces a separation of virtual point charges, or the well-known polarization of the vacuum. So the flow of energy is from the time domain to the negative charge of the point dipole, thence to the positive charge of the dipole or others immediately surrounding it, thence back to the time domain. That is the operation in a "time-forward" sense to the external observer. In a "time-reversed" situation, the 4-circulation appears in the opposite direction. We propose that this fundamental 4-circulation is responsible for and constitutes spin itself. The direction of flow determines the 'polarity of the charge' we observe. In this view, the point dipolarity in the virtual state with its ongoing 4-circulation can be taken as the very definition of energy itself.

**Druge, Paul:** Important German physicist, 1863-1906, who formulated the theory of the free electron gas inside conductors, using it to formulate a theory of metallic resistance.

**Drude electron gas:** The electrons that have broken loose from their orbital bonds in atoms in a conductor, and are thus free to "wander around" and "migrate" — or flow as current when exposed to an emf. Also called just the "electron gas". Note that, in the metal lattice of the conductors, each position vacated by a Drude electron is a "hole" or positively charged little region. Not only do electron currents exist as net negative charge migration in conductors and materials, but also hole currents exist as net positive charge migration from atom to atom, or a sort of "ionization migration flow". Electrons are continually recombining with these "ion holes", however, to reduce the hole current. These considerations are particularly significant in semiconductor materials.

**duality principle:** In quantum mechanics, the principle that photons and other particles propagate like waves and interact like particles, so that their description as only waves or only particles is inadequate.

**Edison, Thomas Alva:** Noted American inventor, 1847-1900, whose staggering portfolio of inventions included the storage battery, electric light bulb, phonograph, motion pictures, carbon microphone, and many others. Edison actually ran multiple "patenting research" laboratories as discovery and patent generating facilities. Not only was he an inventor himself, but he also employed a very good staff of researchers for invention and discovery.

**E-field (electric field):** The electric field intensity  $E$ ; that field on an electric charge (charged mass) which produces an electrical force resulting in a linear motion of the charge. In reality, this electric field *as usually defined* does not and cannot exist in empty space devoid of charge, but only in and on charged matter, since mass is a component of force by  $F \equiv \partial/\partial t(mv)$ . More specifically, the E-field is the local intensity of the field at a point, in its interaction with a unit point static charge fixed at the point. Even more specifically, it is the output of an observation/detection operation, which is a  $d/dt$  operator imposed on the 4-space causal field interaction with the 3-space charge, resulting in a frozen 3-space "slice" or snapshot of the deviation of energy *from* the field, forced to flow around that intercepting charge, at that single instant. In short, the E-field as a force field is an *effect* and not a *cause*.

The greatest error in all electrodynamics is to then assign this same *frozen effectforce field intensity snapshot* — or an implicitly assumed iterative sequence of such snapshots — as the dynamic and nonfrozen *causative field itself* in 4-space, prior to the field's interaction with charged matter. This is the substitution of effect for cause, a grave non sequitur.

When EM theory was founded, the founders believed there was no single **point** in the entire universe where mass was absent; instead, a thin material "luminiferous ether" was considered to fill all space. Time was considered immutable, and there was no concept of a dynamic *spacetime*. Hence at each point in such a material ether, the reaction with charged matter (**etheric** matter) was thought to universally exist. Hence the field was indeed a very material entity, in their concept!

With the destruction of the material ether notion in the 1880s, not a single Maxwell-Heaviside equation was changed to eliminate its implicit assumption of the material ether. Hence this enormous error of confusing the *effect* field with the *causal* field (prior to observation-detection-interaction) is ubiquitous in electrodynamics and therefore in physics itself. The two fields (causal and effect) do not even have the same dimensionality; one is dynamic in 4-space while one is frozen in a 3-space snapshot. This has led to the false notion that an EM force field wave "movesthrough" 3-space, which does not happen at all. What really happens is that, if we assume a continual iterative  $d/dt$  observation operator, we have a continual series of such frozen 3-space snapshots, like the frames of a motion picture film. But none of those snapshots have any inherent motion at all. For a statement of the falsity of the conventional illustration of the "EM wave in space as an orthogonal pair of oscillating E and H fields in a transverse plane", see Robert H. Romer, "Heat is not a noun." *American Journal of Physics*, 69(2), Feb. 2001, p. 109. In endnote 24. **p** 109, AJP editor Romer takes to task "...that dreadful diagram purporting to show the electric and magnetic fields of a plane wave, as a function of position (and/or time?) that besmirch the pages of almost every introductory book. ...it is a horrible diagram. 'Misleading' would be too kind a word; 'wrong' is more accurate. " "...perhaps then, for historical interest, [we should] find out how that diagram came to contaminate our literature in the first place. " Also see charge.

E-field, **motional**: In classical EM theory, the electric field produced by moving a conductor in a magnetic field. Often called *motional inductance* of the field. In the conventional theory, motional inductance is deemed to be **identical** to the inductance caused by a time rate of change of the magnetic field, experienced by the moving conductor. Or vice versa, experienced by a stationary conductor in a moving magnetic field.

E-field, static: In conventional theory, the electric field in the space surrounding a static charged particle, induced by the presence and action of the charged particle. There is no notion as to the *causative mechanism* for this static field of and from a charge, which implicitly is assumed to

just continuously create and pour out EM energy in all directions, thus grossly violating energy conservation. Consideration of this anomaly leads to what has been called the most pressing problem in both quantal and classical electrodynamics: the question of the formation of the fields and potentials associated with the "source charge". Either the charge totally destroys the conservation of energy law itself, or there must be a *virtual* (nonobservable) energy input to the charge, since instruments establish that no observable EM energy is input to it.

For a solution to this problem, see the present author's "Giant Negentropy from the Common Dipole," *Journal of New Energy*, 5(1), Summer 2000, p. 11-23. We later found our solution to be consistent with quantum field theory and with a slight reinterpretation of Whittaker's 1903 decomposition of the scalar potential.

**Ehrenhaft, Felix:** Scientist who performed numerous experiments believed to demonstrate fractional charges. We point out that classical electrodynamics assumes a local flat spacetime, a notion long falsified by general relativity, since 1915. In a local curvature of spacetime, the dynamics of the charge (modern view as the finite difference between two local infinite charges forming a dipolarity) can change the observed value of the net finite charge. So finite fractional charges, or even supercharges, are quite possible.

**Einstein, Albert:** German (Jewish) physicist, 1879-1955, who emigrated to the U.S. and formed special and general relativity theory, discovered and formed the theory of Brownian motion, recommended the development of the atomic bomb to President Roosevelt, and profoundly affected the course of science and the modern world,

**Einstein, Podolsky, and Rosen (EPR) paradox:** Thought experiment in 1935 for measuring two correlated photons separated and at distant locations, protesting that quantum mechanics requires that the particles communicate instantly, which is a "spooky action-at-a distance" (Einstein's phrase). The experiment eventually was performed and it works, just as required by quantum mechanics. The paradox inspired the development of hidden-variable theories.

**Einstein's general theory of relativity:** Mathematical theory of gravitation in which the gravitational force is mathematically described by a curvature in spacetime. In other words, the geometry and its dynamics have become physical agents, doing away with the old notion of the agent being something separate that is occupying inert spacetime. It is important to note that, in general relativity, mass-energy acts on spacetime to curve

it, and the curvature of spacetime acts back on mass-energy to translate or change it. What seems missing from GR — at least in its practice — is the reaction of time-energy upon the geometry to curve it, and that corresponding reaction of the spacetime curvature back upon time and time-energy to change it.

Further, we consider that an exact pattern (template) of curvatures of spacetime and their dynamics exists and is back-acting upon every mass system and its dynamics. This is the *engine* concept. The most general way to engineer matter is not by brute force translation forces, but by forming spacetime engines. Once formed, these engines act upon the interior of any mass placed in the engine region, to eliminate the deltas existing in that mass's resident engine and the impressed engine. *The forces arise from the local spacetime itself, as curvatures in that local spacetime, so the action is from "inside" to "outside" an object, starting and continuing from every point in the object.* The curvatures of spacetime itself furnish the energy for the continuing actions upon the interior of the mass, once we have paid to form the engine. The mass can be acted upon at any level, from its gluons and quarks to its nuclei, to its atoms, its lattice forces and binding energy, etc. Significantly, the Sachs unified field theory applies to physical reality from beneath the quarks and gluons to the entire universe itself, and folds in quantum mechanics, electrodynamics, and general relativity into a single unified field theory that is (in theory) engineerable by higher symmetry electrodynamics means such as Evans' O(3) electrodynamics.

Einstein's postulates: (1) All the laws of physics are equally valid in all inertial frames of reference, (2) the speed of light is the same to every inertial observer, and (3) the observable local effects of a gravitational field are indistinguishable from those arising from acceleration of the frame of reference.

The first is called the special relativity principle, the second is called the law of light propagation, and the third is called the equivalence principle. It is now known that postulates (1) and (2) are not independent of each other. Note that the third postulate implies that any local force is due to a "gravitational field" (acceleration of the frame of reference). It also implies that gravitational force has a mechanism, since quantum mechanics assigns a differential operator, operating upon a potential, to create every force. By extended inference, it can be seen that the third postulate also implies that there should exist a method to turn any type of force (field) into gravitational force (field).

Note that postulate 1 may be violated if two frames remain inertial but each local spacetime contains different hidden engines. So the laws of interaction physics may indeed vary for the same object placed in first one of the frames and then in the second. Engines are ongoing general relativity actions, even in inertial frames. The action may not be translation of the bulk object, but extensive changes to the interior of the object and its interior dynamics at any and all levels.

The Russian physicist Sakharov has strongly postulated that gravitation is not even a fundamental field of physics, of the kind used by Maxwell in his electrodynamics. Instead, in this view G-field is always comprised of, and made from, other fields and interactions upon them. This would seem to follow straightaway since change of any kind of energy in spacetime curves that spacetime, therefore producing a gravitational change. So such has always been implicit in general relativity; it just took Sakharov to formally propose it. See A. D. Sakharov, "Vacuum Quantum Fluctuations in Curved Space and the Theory of Gravitation," *Soviet Physics Doklady*, 12(11), 1968, p. 1040-1041 [English translation.] Sakharov's article (in Russian) in *Dokl. Akad. Nauk SSSR*, Vol. 177, 1967, p. 70-71.

**Einstein's postulates (second postulate extended):** Let us do a little "tinkering" with Einstein's postulates. For the first one, we point out that in the new approach using dimensioning and subspaces, the notion of an inertial frame now has acquired additional complexity! The "gross translation" effects — which tends to be what physics ultimately focuses upon today — can remain the same, and yet vacuum engines can be buried up inside the inertial frame to act upon a mass in non-translating ways. Everything translation-wise can remain the same, but now matter can be transmuted and transformed, etc., still right there in an inertial frame. So when the infolded electrodynamics inside all fields, potentials, and waves are utilized, the notion of "inertial frame" has acquired a higher topology, so that one inertial frame may differ very substantially from another inertial frame, even if the two are not in translation motion with respect to each other. This of course moves one from special relativity into full general relativity, and even there into a slight extension. Special relativity can remain special relativity on the surface, and yet general relativity effects occur "within" the objects postulated to exist in this inertial frame. The "inertial frame" concept in the postulates is now just a sort of special "equilibrium case" of a higher topology "inertial frame" notion. Further, general relativity is extended from the notion of "just translation" to the notion of "internal engines and internal dynamics also". These engines can

be created in mass, in fields and potentials and waves, and in the vacuum itself.

The second postulate now stands as a "special case" of a far more general second postulate. The conventional second postulate actually defines (and limits) "light" to bulk changes in the entire vacuum potential magnitude. It only applies to light signals which are "bulk upheaval" disturbances of the vacuum potential (spacetime), so to speak. The limitation to light speed is an envelope wave speed restriction. Specifically it need not apply to the "inner EM/GR realm" of longitudinal EM waves infolded inside the vacuum potential, other potentials, signal carriers, etc. Superluminal communication is now included in this "hidden variable" or longitudinal EM wave communication. The Fogal semiconductor is capable of infolding and unfolding EM signals, including producing the internal longitudinal EM waves, and during their infolded state these signals are permitted to move at superluminal velocity. This has been experimentally demonstrated by Fogal.

So the second postulate needs to be restated to include the present **statement** as a special case. Notice that the concepts "light" and "speed of light" have now taken on much richer, extended meanings, since there is "outfolded" light and "infolded" light, so to speak. Light now is not just the "external perturbation wave" in the ambient vacuum potential medium (in **flat spacetime**). Instead, it can also be an "internal perturbation longitudinal wave" inside a "net flat spacetime" which does not show on the "surface" at all. Indeed, it may move in the time dimension or in 3-space. It now includes the transmission of an extraordinary "vacuum engine" as well as the usual transmission of just an ordinary signal. The ultimate expression of this extension has unfortunately been the development of such "engines" as infolded robot systems for use in warfare.

These infolded vacuum engines can be visualized as very special sets of longitudinal EM waves and their dynamics, consistent with the Whittaker decomposition. Whittaker's  $U(1)$  symmetry electrodynamics decomposition— particularly when enriched in the higher symmetry  $O(3)$  electrodynamics — applies to the ambient vacuum as a potential (it is a potential since it has energy density). So the "subspace" inside spacetime, so to speak, is just a set of LWs and their dynamics, and that subspace itself is engineerable, just as is the "bulk curvature of spacetime" itself. Further, we may now consider that space itself is just a vast superhighway for such superluminal LWs and their dynamics. Mass is mostly empty space with only an occasional particle here and there and with fields,



potentials, and waves in between. Hence huge masses such as the ocean and earth are actually superhighways for the direct passage of longitudinal EM waves, "engines", special robots, etc. The degree of "transparency" is a function of the degree of cleanness of the LWs — where by "clean" we mean "absence of transverse EM wave residues".

The third postulate has also been dramatically extended and requires revision. As presently stated, antigravity effects do not appear to be included in present physics heretofore. The "gravitational effects and external accelerated effects" notion in conventional physics are still founded purely on *ordinary bulk translation*. Now they need not be. For example, the system can appear to be an ordinary system, as judged by normal "external light" observation. Yet its internal vacuum engines can cause local violation of most so-called "laws of nature." The reason a "law of nature" can be violated is that one is now able to violate the premises upon which it is postulated, and which are required to hold if the law is to hold. Or another way to look at it: any conservation law is the result of a symmetry. Breaking that symmetry allows violation of that specific conservation law. All external symmetries can be broken internally, even if the overall symmetry still applies externally!

The infolded EM inside the "conventional" EM fields, waves, and potentials — and inside the vacuum potential and spacetime itself — dramatically changes the present theories of electromagnetism, quantum mechanics, and general relativity. Further, for the first time the Sachs unified field theory allows an *engineering* approach that simultaneously crosses, includes, and extends all three disciplines in the required manner. The approach can be placed into good engineering models based on the Sachs work, particularly using the  $O(3)$  electrodynamics subset spearheaded by Evans, and the models can be tested and verified or falsified. See **frame, reference;** and **superluminal communication.**

**electric field:** (See also discussion under **E-field**). The *conventional* definition is this: "1. a region in space in which a stationary electric charge experiences a force due to its charge. 2. the electric force per unit test charge." Quoted from *Dictionary of Science and Technology*, p. 720. That definition is flawed. Consider the "spatial aspects" of part 1. If an electric field is defined as a force per unit charge (per Part 2), it is not a region in massless space but is an effect of something existing in massless spacetime and interacting with the charged 3-spatial mass. The electric field *prior to interaction and observation of the interaction* is indeed related to a region in "spacetime", because it is identically a curved spacetime region. In the Sachs approach, general relativity and electrodynamics have become one

and the same. So prior to interaction, the *field as it independently exists prior to interaction with charge* has become a curved spacetime region, and the field-in-space is *purely* a spacetime curvature. Again, there is no such thing as a massless force. It is the hoary old mechanics notion of a separate force acting upon a separate mass that is a total non sequitur. The interaction of the massless field in space with a mass to produce a force, *of which that mass is actually a component*, is a separate consideration from the field as it exists in space prior to interaction. The result of this entity's **interaction** with charged mass has nothing to do with *what an electric field* is but with *what it does to charged mass*. Further, the force evidenced on a charged particle is not due to its charge; the particle has that charge always, whether or not there is a net force evidenced on it!

Part 2 is a little better. The only problem is, it totally disagrees with the notion of the field as an entity existing in spacetime prior to interaction **with** charged mass. In other words, here it's a "force on a charge", which is an effect (force consisting partially of the charge) occurring after the interaction. Again, the conventional definition states only what the field *does or accomplishes*, not what it *is*. Hopefully the reader can now begin

to see what terrible difficulties await anyone who seriously attempts *foundations definitions*. Feynman sums it up admirably in one of his famous statements: "*Everything we know is only some kind of approximation, therefore, things must be learned only to be unlearned again or, more likely, corrected.*" An additional difficulty is that the very **notion** of a separate massless force — independent of the mass on which it operates - is fictitious, yet continues to be widely used. Recalling that any true definition is an identity and not an equation, let us start with the definition of  $\mathbf{F} = \text{force} = \frac{d(\mathbf{mv})}{dt}$ . As can be seen, force is a system **comprised** of (i) a mass component and (ii) a nonmass component. The force is not something separate from the mass, at all! Further, force is not **even** unitary. It's a system comprised of two coupled components; the mass and a coupled (interacting) gradient in a potential flux. *Note that  $v$  involves motion through, and interaction with, the virtual flux comprising the vacuum potential. Note that  $dv/dt$  involves a gradient in that flux interaction with the mass.* Unfortunately mechanics is still using the medieval concept of a "separate force acting upon a separate mass." That is wrong, unless we change the fundamental definition of force itself. See, e.g. **Robert Bruce Lindsay** and **Henry Margenau**, *Foundations of Physics*, Dover Publications, New York, 1963, p. 283, where the authors emphasize that a "field of force" at any point is actually defined only for the case when a unit mass is present at that point. The reason can be seen: mass is a necessary component of force, and without mass present there cannot be a

force present. For that reason, the force field in matter is a quite different beast from that "same" force field in empty spacetime. The first is a 3-spatial snapshot of an ongoing 4-spatial interaction, while the second is just a curved region of that "empty" spacetime without any ongoing reaction necessarily.

**electric dipole:** See **dipole**.

**electrodynamicist:** A specialist in electrodynamics — the physics of the relationships between electric, magnetic, and mechanical phenomena — and especially a specialist in electrodynamics *theory*. Essentially all electrodynamicists are versed in U(1) electrodynamics, and a much smaller number are versed in more advanced (higher group symmetry) electrodynamics such as O(3) symmetry electrodynamics, unified field theory electrodynamics, non-Abelian electrodynamics, etc. The electrodynamics field is actually a very vast field indeed, touching everything in physics, chemistry, etc. When one needs a particular electrodynamics problem solved, it often calls for a special category of electrodynamicist and not just an electrodynamicist in general. One must therefore sometimes examine the background of the electrodynamicist making a statement or a pronouncement; electrodynamicists after all do have differing views and differing disciplines within the field. And something may be perfectly true and acceptable in O(3) electrodynamics, yet not even exist in U(1) electrodynamics. As an example, the Aharonov-Bohm effect exists in O(3), but not in U(1). U(1) assumes a flat local spacetime (falsified by general relativity almost a century ago) and an inert vacuum (strongly falsified by modern particle physics and quantum mechanics), while O(3) is perfectly content to include and model curved spacetime and active vacuum also.

**electromotive force (EMF):** A difference of potential created by sources of electrical energy — i.e., by separated charges (dipoles) — which can be utilized to drive electrical currents through external circuits. As a difference of potential, that constitutes a gradient and hence a force. Also, open circuit voltage, or the limit of the potential difference between the source's terminals as the current in the external circuit approaches zero.

This term is poorly named and also quite confused in the standard theory and usage. First, emf is supposedly not *a force* at all. It is a difference in potential; hence it is measured in volts. It is very difficult to imagine a "difference in potential" at a single point unless one is dealing with a multiply connected space. So if the difference in potential is between two adjacent points, then that constitutes a force between the two points. Also,

emf is not considered an E-field, since that is a field of force. Yet it is in fact a  $\nabla\phi$ , restricted to the direction between the two measurement points, and  $-\nabla\phi$  is considered to be an E-field in the EM theory! As can be seen, **one** will not find a truly logical definition of potential or emf in the present texts and science literature.

For this reason the standard theorists say that the term emf is sometimes used as equivalent to a difference in potential, but that strictly speaking it **should** be applied only to a source of electrical energy. The problem is that **most** conventional theorists are unaware that a potential *identically* is a bidirectional flow of energy in 3-space, but a 3-space flow where *the energy enters from the time-domain (complex plane) and is caught in 3-space by interaction with charge, in a frozen snapshot (observation). The energy actually enters each 3-space point in the 4-space potential, from the time domain.* It moves across a dipole in space (present due to the quantum mechanical polarization of the vacuum), to the opposite charge, thus returning from the immediate region of that second 3-space point (or points) back to the time domain. Since conventional theorists are unaware that a potential is a hidden negentropic energy flow circulation process involving broken 3-symmetry, broken t-symmetry, and a special 4-symmetry between t and 3-space, the theorists have been unable to consider the potential in general as a direct source of energy flow. Yet they are forced to consider a potential difference across the terminals of a source as "somehow a flow of energy, that generates forces upon the electrons to propel them through the circuit as current flow."

In the new viewpoint, a resolution is achieved of these incongruities by more accurately defining the E-field with respect to the potential as  $\mathbf{E} = -[\nabla\phi + \mathbf{q}]/|q|$ . It is noted that  $-[d\mathbf{A}/dt] \bullet \mathbf{q}/|q|$  also produces an E-field, so **that the full** definition of the E-field is  $-\nabla(\phi + d\mathbf{A}/dt) \bullet \mathbf{q}/|q|$ . Note that dividing q by |q| does not remove the q unit from the corresponding dimensionalequation, since q is dimensionless. However, one volt represents one joule (of excess energy) *diverged from the potential*, per coulomb of interacting charge. *The energy density flow in an electric circuit is in the voltage, in the emf, and it is not in the current per se.* The **electron** current (drift current) carries the excess energy that is being dissipated as work in the circuit, but in a nominal circuit the drift current only moves a few inches per hour. Half the energy collected in the potentialized circuit is dissipated in the external circuit and external losses, and half is dissipated in forcing spent electrons in the ground return line back up **through** the back-emf of the source, performing work inside the source to dissipate its separation of charges. Left alone, any dipole will

furnish emf indefinitely, freely receiving the energy from the time domain (complex plane) and outputting it in 3-space via the reinterpreted Whittaker 1903 decomposition, in a circulation where at each point in it the energy enters from the time domain and thence returns back to the time domain. The free flow of EM energy will continue unabated from the undestroyed dipole, regardless of how many external loads and losses are powered (how much energy is collected and dissipated from the ongoing flows representing the potential). So *electrical circuits should be developed which allow few or no electrons to be forced back up through the source dipole to dissipate its separation of charges and destroy the dipole.*

**electromotive force, back (back emf):** Back emf is a loose term for the *counter-electromotive force.*

When the source is powering a circuit or circuit element, the term "back emf" is used to refer to the forcing of current (electrons) back up through the source against its emf, thereby performing work inside the source to *dissipate* its separation of charges (its dipolarity). When a potential source of electrical energy — such as a capacitor, an inductor, or a rotating machine — is receiving energy from a source and converting it to *dissipative* power and work, that "powered" device is said to develop a *counter-emf*. A source has a built-in emf *a priori*, and this emf is holding its charges separated so that it is dipolar. When electron current is forced backwards through the source against its emf, work is performed against the internal resistance of the source to dissipate its separation of charges, thereby *dissipating* the source dipole. If electron current is not allowed to flow back up through the source against its back emf and through its built-in counter-emf, no dissipation of the source dipole occurs, even though energy density (not *electron current*  $dq/dt$  but *energy flow*  $dq/dt$ ) is flowing from the source and can be collected in *collectors* in the external circuit to store the energy as a created local energy source. This collected energy can then be shuttled to a separate load circuit and released, to provide a "heat pump" cycling operation and overunity coefficient of performance.

Nikola Tesla in fact knew how to shuttle energy at will in a circuit in such fashion, as Barrett's quaternion analysis of Tesla's actual patented circuits has revealed. [See T.W. Barrett, "Tesla's Nonlinear Oscillator-Shuttle-Circuit (OSC) Theory," *Annales de la Fondation Louis de Broglie*, 16(1), 1991, p. 23-41.] Note that a rigorous analysis of those same circuits, using tensors or vectors (lower topology algebras), will not show the effect. One

**needs** a higher-topology algebra such as quaternions or Clifford algebra, or **the** significant properties of such circuits will be entirely missed.

When the original source dipole is not dissipated because electron current is **not** passed back up through its back-emf to scatter the charges, the **original** source dipole will continue to furnish emf indefinitely because of **the** proven asymmetry of its opposite charges in the seething vacuum energy flux.

The terms emf and counter-emf are normally applied only to recognized sources of electricity. Emf is computed as the algebraic sum of the **potential** differences acting in a circuit attached to a source. Back-emf (counter-emf) is computed as the potential difference internally through the source, between its terminals. The back-emf is thought to be necessary in producing *a powered device or component in the circuit*. Actually, *its main application (the ubiquitous closed current loop where all the external circuit current is passed back through the back-emf of the source dipole) is to prevent COP > 1.0 electrical power systems from being developed and utilized, and for every electrical circuit to self-enforce Lorentz symmetrical regauging during its de-excitation phase*.

**electron:** A stable elementary particle in all atoms, and having — in "forward time" — a negative charge of  $1.602 \times 10^{-19}$  coulombs, a spin  $1/2$ , and a mass of  $9.11 \times 10^{-31}$  kilograms. If time is reversed, the charge (but not the mass) of the electron is reversed and it becomes a positron. Note this is an equivalent *observed* 3-positron, in a material lattice after interaction with charged matter, and not the mathematical equivalent represented by Dirac sea holes in the 4-vacuum prior to interaction with mass.

The "electron" may also exist as a negative energy, negative charge, negative mass-energy 4-state (Dirac hole) in the vacuum itself. In that state, the negative energy 4-electron is the source of negative energy fields and negative energy potentials. When the associated nondiverged and unaccounted Heaviside energy flow component is also accounted, the Dirac sea hole negative energy 4-electron can be manipulated in "anti-circuits" to directly engineer local antigravity, quite strongly and practically.

electron gas: A system of electrons with only weak interactions, so that the electrons may be regarded as moving independently. In many ways, such a collection of electrons can be treated as a gas. See Drude Electron gas.

**electrostatic scalar potential:** A *static* (stationary, in the sense that a perfect waterfall would appear stationary) ordering in the virtual photon flux of vacuum. The notion of "static" in the term "electrostatic" is misleading and should be replaced by "stationary" since the underlying active vacuum medium is always in violent motion, and there is nothing truly "static" in the universe. But an *equilibrium* or *stationary* condition can exist as an external envelope condition, even with continuous violent motion internally, so that a stationary entity or form persists. An example is a perfect whirlpool in a river.

The electrostatic scalar potential decomposes into a harmonic set of bidirectional phase conjugate longitudinal EM wavepairs, as shown by E. T. Whittaker in 1903. Hence the electrostatic scalar potential is an overall curvature of spacetime with internal longitudinal EM order and dynamics.

**ELF:** Extremely low frequency. Used to describe EM fields whose frequencies lie in the range from just above 0 Hz (direct current) to 300 Hz. This includes power line frequencies (60 Hz in U.S. and 50 Hz in Europe) and frequencies used by certain U.S. military ELF communication systems such as for submerged submarines.

**EMF:** Acronym for electromotive force. See discussion under electromotive force.

**EM field:** Electromagnetic field. In its loose usage, it refers in a very broad way to any field, force, or energy associated with electromagnetic interactions, charges and currents. Thus "EM field" includes electrostatic fields, magnetostatic fields, electromagnetic fields (including radiation and induction), vector-potential and scalar-potential fields, Hertz potentials, Fitzgerald potentials, Whittaker potentials, Debye potentials, etc.

In its precise usage, "EM field" conventionally refers to an EM "force" field, such as the E-field, D-field, B-field, and H-field. In classical electromagnetics (CEM), as a holdover from the old assumption of a material ether, the force fields are considered (erroneously) to exist in mass-free space, and they are also considered to be the primary causes of electromagnetic phenomena. This is a non sequitur, and it involves substituting the effect for the cause.

In the new viewpoint, *the force* fields do not exist in vacuum, but only in and on and of the charged particles themselves, where mass is present to form one component of the force. The force fields are therefore effects and not primary causes. The primary causes of all electromagnetic phenomena is taken to be the potentials; however, the hidden

Stoney/Whittaker/Ziolkowski internal structures of gradient-free scalar potentials may interfere to cause potential gradients in and on charged particle systems. [In O(3) and other higher group symmetry electrodynamics, this internal structuring and dynamics is far richer.] This therefore includes distance-free scalar potential interferometry and action at a distance, as well as vacuum engines.

The new view uses Sachs' unified field theory, and considers that the EM field in the vacuum, or an EM potential in the vacuum, involves and identically is curvature of spacetime. It follows that the internal EM structures of "ordinary" EM are also spacetime curvatures, where the specific pattern of these ST curvatures constitutes a very special kind of spacetime engine that acts upon any local mass in a specific manner determined by the individual pattern of curvatures. Thus the new view is a unified field theory where GR has become EM and EM has become GR, and where higher symmetry EM — such as O(3) group symmetry EM — can involve or produce gravitational, temporal, and inertial effects as well.

EM force field in the vacuum (a false concept : The erroneous notion that there exist forces in the vacuum, so that the set of forces at a set of spatial points forms a force field. Presently classical electrodynamicists accept the same E-field in vacuum as exists upon a charged mass when the vacuum E-field interacts with that charge, but it is asserted that the force is zero. This is easily falsified by defining force  $\mathbf{F}$  as  $\mathbf{F} \equiv \partial \mathbf{p} / \partial t = \partial / \partial t (m \mathbf{v})$ .

By expanding the term on the right, one sees that both terms in the expansion include mass. Mass is thus a *component* of force. If mass is absent, there is no force present, thus no force field present. The field in

space and the "same" field in mass differ precisely by a mass term in their fundamental units. The field in massless space may be taken as a curvature of spacetime. Zero field in space means a flat spacetime; a nonzero field in space represents a curvature of spacetime. A nonzero field in mass means a curvature of spacetime (a 4-space entity) interacting with mass (a previous 3-space observation) to produce a force consisting of that field and mass interaction. There is no separate force acting on a separate mass, and mechanics has been wrong in assuming on for hundreds of years. Instead, there is a force produced by the interaction of a massless 4-field

(spacetime curvature) entity with 3-spatial mass. It is that *interacting and ongoing entity or process* that is a force field. Speaking of such a force field in space, is speaking of the force field that would exist in that space if every point had a unit point static charge and charged mass. As Feynman and Wheeler pointed out, no force field as such exists in space, but only



the potential for a force field exists there, in case some charged mass is brought in to interact and have the forces developed upon its charges.

**EM generatrix:** Whatever generates electromagnetics, particularly the fields. Since all EM energy comes from the time domain and returns to it, time is the ultimate EM generatrix. The circulation of EM energy from the time domain to 3-space and back, or vice versa, is a function performed by the broken symmetry of every charge, considered as two infinite dipolarities with a finite difference that is the observed charge listed in texts and handbooks.

**energetics:** Energy as the primary thing in the universe. Rankine's term later raised to the forefront by Ostwald. Modern Russian term for advanced higher group symmetry electromagnetics, where the electro-dynamics is a subset of an engineerable unified field theory. In the U.S., a model approaching the Russian model is given by Evans's O(3) electro-dynamics as a special subset of the electro-dynamics used by Sachs in his epochal unified field theory. Thus there is a growing, engineerable unified field theory (energetics theory) in the U.S., being provided by Evans, Sachs, and others. A solid basis for energetics can be realized from the giant 4-space negentropy EM energy circulation involved with every charge, so that all "EM energy in space" and time itself comes from that circulation.

**energy:** Usually erroneously "defined" as the "capacity to do work". This is a total misdefinition since it would define energy as the ability to change its own form. The closest to a legitimate definition of energy appears to be: *energy is the invariance of that which is varying* (Lindsay). However, note that this definition violates Aristotelian logic (but does not violate five-law logic developed in this book). Another try at it might be: *"Energy is any deterministic or coherent structuring, either dynamic or stationary, existing in the virtual particle flux of vacuum."* While that sounds good, it still involves the nonchanging aspect of the changing flux — much like considering a whirlpool in a river as being a "static" thing. So it is still "the invariance of that which is varying", which is an identity of opposites. We conclude that 4- or 5-law logic is necessary in order to define energy, since the defining logic must encompass the identity of opposites. Feynman simply stated: *"It is important to realize that in physics today, we have no knowledge of what energy is\_."* [Richard P. Feynman, Robert B. Leighton, and Matthew Sands, *The Feynman Lectures on Physics*, Addison-Wesley, Reading, MA, Vol. 1, 1964, p. 4-2.]. In Aristotelian logic, there is no acceptable definition of energy. In 5-law logic, the second definition holds since opposites can indeed be identical. Now to more practical aspects:

For our purposes, there are three major types of energy in 4-space: (i) 3-spatial energy, which includes energy in one, two, or three of the spatial dimensions, (ii) mass-energy, which is 3-spatial energy compressed by the factor  $c^2$  but still in 3-space, and (iii) time-energy, which is 3-spatial energy compressed by the factor  $c^2$  but now placed in the time domain.

**Note** that time-energy has the same density as mass-energy, and hence the same spacetime-curvature effect and gravitational capability.

The major implication of the new view is that the conservation of energy law is extended: Now it is the total of the 3-spatial energy, mass-energy, and time-energy that must be conserved. Transduction between time-energy and either of the other two forms, or both, will violate the conventional conservation of the sum of the 3-spatial energy and the mass-energy; every charge and every dipole is an example. Use of time-polarized and longitudinally polarized photons and EM waves particularly may involve the extended conservation law, e.g., as utilized in cold fusion and its time reversal zones, and as involved in the outpouring of observable EM energy from every charge in the universe, with no observable energy input.

energy collection/collecting: In electromagnetics, placement of an interceptor/collector — e.g., a charged particle — into an impinging EM energy flow, so that some of the flow is diverted around the intercepting particle. We may say that the flow of energy has been "reordered" into a stream diverged around the intercepting charge. The diverged part of the total energy flow is what is calculated as the Poynting energy flow component, and is what is referred to as the "collected" energy or the "potential" of the charge.

However, neither charge nor potential are acceptably defined in conventional electrodynamics, but they can be defined in the new approach. We are now able to see something more fundamental. By the giant negentropy mechanism, the charge is involved in both the time-energy stream and the vacuum flux set of virtual particle spatial-energy streams. "Charge" is not just related to the mass of the particle, but is the entire ongoing set of the dynamics as well as the mass (the "nondynamics", so to speak). When a charge is placed in a field, that field is a change to the local dynamics, which is a change to the charge itself. Both the dynamics and the mass (the "nondynamics" constituting the charge are altered. So one does not have the "field acting on a separate charge", but instead we have the charge with its previous set of dynamics transformed into the altered charge with a new set of dynamics and a new mass. Similarly when a charge is placed in a potential. Charge is also not a 3-

spatial situation and process, but a 4-spatial situation and process. If the internal structuring is also important, it becomes an  $n$ -spatial situation where  $n > 4$  and even where  $n \gg 4$ . To deal with sophisticated engines,  $n \gg 4$  is necessary in the modeling utilized.

**energy dissipation:** Refers to the scattering or disordering of energy; at fundamental basis, it refers to the changing of an altered charge (see energy collection/collecting) back to an unaltered charge. In other words, it is a special decay process whereby an "excited charge" (so to speak) decays back to its "normal state" by releasing dynamics (energy) back to the vacuum. The energy itself is not destroyed, but its "collecting pattern" or "flow pattern" as coupled to the charge is disrupted and altered or destroyed. There is also the connotation that *the dissipated energy is lost as far as any re-use of it by the system*. We point out that only collected/collecting energy can be scattered; it is the collecting *process* (the entire alteration of the normal charge dynamics) that is "destroyed" - or more exactly, *transformed* — not the energy itself.

**energy, electromagnetic:** From a vacuum and quantum mechanical viewpoint: a deterministic or coherent structuring, either dynamic or static, existing in the virtual-photon or charged-particle flux of vacuum. Since a photon may also be considered a positron-electron pair (if we multiply each by time so that they are  $qt$  rather than  $q$  in fundamental unit form), the flux of photons in the polarized vacuum necessarily also includes the flux of charged virtual electrons and positrons. From a spacetime viewpoint: a curvature of spacetime, or set of such curvatures. If a deterministic set of spacetime curvatures (a template) is involved, then an engine is involved and the energy is said to be "dimensioned" (internally structured).

**energy flow:** Generally considered as the passage of energy, in any form, in one direction or generally in one direction in a given 3-space. To first order, our definitions of energy treat energy flow in a given space as (1) a directional change (propagation) of the vacuum energy and its form, or (2) as a directional propagation of a curvature of spacetime or a set of curvatures of spacetime. *The terms "energy flow" and "flow of energy through space" are not precisely defined in physics! They are not going to be defined, at least not in ordinary Aristotelian logic terms, since energy itself is not precisely defined, and one of the best struggles with the concept of energy concludes that it involves invariance in the midst of change, which is a violation of the third law of Aristotelian logic and therefore of the other two as well.*

Indeed, the "EM wave flowing through 3-space" does not exist (see previous comments quoted from Romer). What does exist is an ongoing 4-space process, assumed to be continually and iteratively interacting with a unit point charge to "detect" or "observe" it as an iterative series of frozen

3-space snapshots, in memory-recalled serial order much like the frames of a motion picture film. Nonetheless, we must keep our sense of humor and proceed as if we knew exactly what we were speaking of when we use the **concepts** "energy", "energy flow", and "energy propagation through 3-space". If one dwells on the problem without humor, one is led to

Hawking's grim but perceptive statement: *"All we ever know is our models, but never the reality that may or may not exist behind the models and casts its shadow upon us who are embedded inside it. We imagine and intuit, then point the finger and wait to see which suspect for truth turns and runs. Our models may get closer and closer, but we will never reach direct perception of reality's thing-in-itself"* Ultimately we do not know physical reality itself, but our mental modeling of it, as best we can "fit" our modeling through comparison with our sensory and perceptive sensations.

**energy flux:** The passage of energy flow, in any form, through a unit area, and in any given direction (usually all directions). This includes both passage in a single direction, or passage in multiple directions at once. See flux. Sometimes taken as that component of the net flux through a unit area at right angle to the area.

energy, free: In our usage, free energy is what is obtained from any environment or entity which freely emits, furnishes, or makes available energy which either can be collected and used as furnished, or can be transduced into usable form and collected and used to power loads and do useful work. The word "free" does not apply to *costs*, but rather to the source of the energy. Since energy can neither be created nor destroyed, energy is always available free for the taking (collecting and using) if we

bit learn how. *We never pay for energy per se, but for the manipulation and processing of the energy.* The notion of extracting and using free EM energy from the vacuum involves five key concepts: (1) the local vacuum/spacetime itself is filled with EM energy of generally unusable form (2) some sort of organizing principle is utilized in one part of the circuit or system to cohere the vacuum energy and transduce it into usable EM form (every charge already individually does that; we just have to learn to do it in a larger ensemble), (3) a gating mechanism is utilized to divert the vacuum energy now in usable EM form from the active vacuum to the external circuits or load parts of a device, (4) the coherent gated

extra energy available in the external circuits or load parts is intercepted by those circuits or load parts, couples to them, and potentializes them with extra EM energy, so that the energy is collected by the system and regauges the system asymmetrically, and (5) the external circuits or load parts then scatter or dissipate the coupled extra energy to produce useful work (physical changes in the load), without destroying the organizing and gating mechanism that is extracting and furnishing usable EM energy from the vacuum.

**energy source:** A function or entity which furnishes energy by either gating it from one energy reservoir to our system or locality, or by transducing available unusable energy into usable form and then emitting the usable energy. Technically speaking, since energy cannot be created or destroyed, there is really no such thing as a *creative* "energy source", though the term "source" seems to imply such. So-called "energy sources" actually gate and/or transduce energy, changing it from one form to another, from one direction to another, etc. All EM energy in the universe comes from the time domain into 3-space vacuum, onto charge, and back to the time-domain, in a giant ongoing negentropy 4-circulation as freely provided by the "source charges".

**engine:** Deterministic pattern of structures, with their concomitant dynamics, in the flux of the vacuum. Also, deterministic patterning of curved spacetime curvatures and their dynamics that comprise an overall larger spacetime curvature, or internally comprising an *overall* "uncurved" spacetime.

**engineering, entropic:** Engineering or designing systems and processes in equilibrium with their external active environment, and whose operation "spills" or wastes all the energy input to them, and which do not freely recover and use the dissipated or wasted energy. Entropic systems — which are the products of entropic engineering — thus have  $COP < 1.0$  and function in forward-time, and classical equilibrium thermodynamics with its infamous second law rigorously applies because the system is designed to self-enforce the equilibrium condition, often called by other names such as Lorentz symmetrical regauging.

**engineering, negentropic:** Engineering or designing open systems and processes far from equilibrium in their exchange with their active environment, whose operation freely "receives" excess energy from the environment, so that they permissibly output more energy than the operator inputs, the excess being received from the external environment. As an example, simply making a common dipole or assembling a charge

initiates a giant negentropy operation that persists indefinitely (as long as the dipole or charge persists).

entropy: Thermodynamics state term representing a measure of an equilibrium system's capacity to undergo spontaneous change. In short, a quantity that measures the availability of a system's energy for conversion to work. The entropy of an open system not in equilibrium with its active environment cannot even be computed, because the state cannot be computed.

Entropy is given by  $dS = dQ/T$ , where  $dS$  is an infinitesimal change in entropy for a system absorbing an infinitesimal quantity of heat  $dQ$  at absolute temperature  $T$ . In statistical mechanics, entropy is a measure of the disorder in a system and is given by  $S = k \ln P + C$ , where  $S$  is the value of entropy (disorder) for a system in a given state,  $P$  is the probability of that state's occurrence,  $k$  is a fixed constant, and  $C$  is an arbitrary constant. Intuitively, the concept of entropy corresponds to the concept of disorder. We specifically call attention to the fact that the "S" used in representing entropy is not at all the S used for Poynting energy flow in electrodynamics.

entropy, negative (negentropy): In a sense, the reversal of disorder, or reversal of entropy. Another way of defining negentropy even more rigorously — for electrodynamics — is to define it in spacetime as a *broken 3-symmetry in EM energy flow with concomitant relaxation to a more primary 4-symmetry between time-energy flow and 3-spatial EM energy flow, where time-energy flow is transduced into 3-spatial EM energy flow and then back to time-energy by the entity — such as a common dipole — causing the broken 3-symmetry.*

e quilibrium: *In physics*, the state of a system in which opposing forces balance each other — i.e., sum to a vector zero. However, the *vector* zero summation does not represent "total absence" of everything, and the forces and their energy remain even though comprising a net vector zero system. Even a pure number zero may also be taken as a set of nonzero numbers; e.g., (+5 -3 -2). So even zero need not be total absence, but can be a "balanced set of presences". Or zero can be regarded as an overall equilibrium condition comprised of a set of disequilibria conditions.

Indeed, a vector zero summation system of nonzero forces comprises a stress potential, and it contains stress-energy doing work upon the stressed system. *In mechanics*, a system of particles — where the net force acting upon each constituent particle is zero — is said to be in equilibrium. *In chemistry*, the state of a solution where the forward and reverse reactions

are equal and balance each other, so that the chemical reactants and products maintain the same amounts. Again, the notion of equilibrium involves the "stationary" notion (similar to a perfect whirlpool in a perfect river) of the overall invariance of some set of ongoing dynamic changes.

**ether:** An extremely fine material substance originally theorized to exist in space in lieu of sheer emptiness. The problem is considering space as emptiness in the first place, which it is not. Instead, space (more rigorously, spacetime) is a plenum and highly active (as in the general relativity view a half-century after Maxwell's seminal paper). So there is no need to "fill empty space" with something, because in the modern view there is no such thing as empty space.

**Evans, Myron W.:** Noted chemical physicist, primary developer of O(3) symmetry electrodynamics, and Director of the Alpha Foundation's Institute for Advanced Study (AIAS). Papers produced by the AIAS are critical to understanding extraction of EM energy from the active vacuum, engineering of vacuum engines, and development of a revolutionary new healing method by time-reversing diseased or damaged cells back to a previous healthy state.

**excess collected energy:** Collection by an interceptor/collector of a greater fraction of EM energy flow impinging upon it and also surrounding it, than is normal. See **Bohren experiment**.

**exciton:** A bound electron-hole pair in a semiconductor. Excitons are temporary formations and they decay by recombining, but they have a specific half-life before recombining during which they migrate through the semiconductor crystal. When the hole and electron recombine, then — if the curvature of spacetime relaxes to a flat spacetime, which is not overtly stated in classical EM theory — the recombination releases energy in the form of a *photon*, or sometimes in the form of several *phonons*. **Note** that the "hole" is an "absence of an electron" from a position in a lattice usually containing an electron, so that it exhibits a net positive "change in the charge field" at that point. Specifically, this "lattice electron charge hole" is not a Dirac Sea hole in the vacuum, which is an entirely different matter. On the other hand, if the hole and electron recombine and the curvature of spacetime does not relax to a flat spacetime *because of other curvature-sustaining involvements*, then no "pair annihilation" radiation is emitted. It is the relaxation of the curved spacetime (when hole and electron are separated) back to a flat spacetime that causes photon or phonon emission.

**exothermic:** Literally, "giving off heat", or emitting scattered EM energy. Producing time-forward EM energy from a "source" by reducing the ordering (internal energy) of the source.

**Faraday, Michael:** Noted English physicist and chemist, 1791-1867, who discovered field theory and electromagnetic induction. Faraday also invented the dynamo and formulated his laws of electrolysis. His work directly inspired Maxwell, who vowed to study no other electromagnetics theory until he had captured Faraday's work in a mathematical theory.

**Fermion:** A fundamental particle which has spin angular momentum of  $(n+1/2)h$ , and which obeys Fermi-Dirac statistics. Examples are baryons and leptons, which are subject to the Pauli exclusion principle.

**Feynman, Richard P.:** Noted physicist, Nobelist, and co-developer of quantum electrodynamics. Feynman is particularly noted for his refreshing three volumes of physics: see Richard P. Feynman, Robert B. Leighton and Matthew Sands, *The Feynman Lectures on Physics*, Addison-Wesley, New York, 1963. The book is particularly noteworthy in that it gives the student some insight into foundations problems in physics. E.g., in Vol. I on p. 2-4, Feynman defines the electric field not in terms of force per unit charge per se, but in terms of its *potentiality* for producing a force only when a charge is present for the force to be developed upon.

**fiber fuse:** Effect in optical fibers or fiber optic cable, whose core contains germanium, whereby heating the cable at one spot with a small flame will launch a focused traveling heat energy effect which melts a small hole in the core about every centimeter, and marches down the cable at about a meter per second to the end of the cable, destroying the optical transmission capability and ruining the cable. Oddly, by igniting the fiber fuse from the other end of the damaged cable, a reverse fiber fuse effect will often march back down the cable in similar fashion except that it fills in the melted holes in the core, restoring the transmission capability of the cable. If the energy required to melt all the holes (or fill them again) is taken into account, the amount of energy required to launch the fiber fuse is much less. This phenomenon does not appear to have an adequate technical explanation at present.

field: In mathematics, a set with two binary operations. In electromagnetics in more common mathematical terms, it is a region consisting of magnitudes and/or vector directions assigned to some active entity (e.g., spacetime itself) at each point in the region.



In physics, "a region of space marked by a physical property, as gravitational or electromagnetic force or fluid pressure, having a determinable value at every point in the region." [Thanks to *Webster's II New Riverside University Dictionary*.] Note the very special use of calculation of magnitude: one does not calculate the magnitude of the field itself, which fills an entire region. Instead, one calculates the magnitude of the *reaction* of that field with some interceptor/reactor at a given point — i.e., the *effect* of that field upon some mass entity. That is at best a measure of the *local intensity* of the field, not the magnitude of the entire field per se. For that reason, often we speak of calculating the field intensity, which is far more accurate than saying that we are "calculating the magnitude of the field". So we do not really calculate the "magnitude of the field," and in fact such a calculation does not occur in any textbook. Instead, we calculate the *reaction cross section* — in the case of electrodynamics, for an assumed unit point static charge — of the field at a point in the region or space occupied by the field. *We actually calculate what is deviated or diverged from the field, around an assumed interceptor, not the field itself.* This means that we calculate the result or *effect* of a detecting/observing action, and a frozen 3-space snapshot of that ongoing interaction, since all observation is 3-spatial. To then state that this same field exists in space prior to the interaction, and is what causes the interaction, is a gross non sequitur and confuses the effect with its own cause. This ubiquitous non sequitur widely permeates electrodynamics and mechanics, and it is one of the greatest scientific logical errors in history.

**field, scalar:** In the standard view, a field, to any point of which is assigned a magnitude only. However, "magnitude" of the EM field in the standard usage refers only to the amount of energy deviated (diverged) around a fixed intercepting unit point charge, per the conventional "detection by reaction" model. Again, note the serious logical errors in the conventional usage. One cannot define the field in terms of what is diverged from it! At best one has defined the "intensity" of the field's interaction with a given standard interactant (charge). So in electrodynamics the term "scalar field" would be better replaced with "scalar field intensity", at least for many applications.

**field, vector:** In the conventional view, a field, to any point of which is assigned both a magnitude and a direction. Again, the standard view also implements that assumed reaction with a detecting unit point static charge, and the "magnitude" used is just the difference between the amount of energy piled on the "front" of the interacting unit point static charge and the amount of energy pile on the "rear" of the interacting unit point charge.

The "direction" is from the center of the "high energy" pileup to the center of the "low energy" pileup around this fixed intercepting unit point charge. Again, note the serious logical errors. One cannot define the field in terms of what is diverged from it and the direction of the difference in "energy pressure." At best one has defined the "intensity" of the field's interaction with a given interactant (charge), and the "direction" established by the difference between the frontal and rear energy pileups on the interacting charge. The term would be better replaced with "vector field intensity".

flat (uncurved) spacetime: In our view, a vacuum/spacetime whose virtual particle flux intensity — and therefore its local energy density — does not change as a function of spatial position or averaged time. That is, in our view a flat spacetime is also identically a quantum mechanical vacuum whose virtual particle flux and energy density are constant in magnitude and internal constitution with respect to spatial position and in averaged time. Note that in this extended view, a flat spacetime (vacuum potential) can still contain vacuum engines, and thus still be *dimensioned*. *In that case*, contrary to normal physics, the flat spacetime itself will still interact with an embedded object and *change* it internally, even though it does not *translate* it externally. To perform transmutation of elements, e.g., one is interested in just such engines and not in spatially translating the element being treated. This dimensioning or activation of the local flat spacetime can result in an otherwise unexpected, seeming violation of one or more laws of nature in the dimensioned region, and easily results in violation of conventional physics which does not take into account engines and dimensioning of a flat spacetime. Note also that this allows a differentiation between the actions of two inertial frames, if the frames are differently dimensioned. As we stated, this is a deliberate extension of orthodox physics. See also dimensioning, and Einstein's second postulate — extension of.

fluctuation theorem: Theorem advanced by Denis J. Evans et al. at the Australian National University in 1993 that appreciable and measurable violations of the second law of thermodynamics occurs for small systems over short time scales. See D. J. Evans, E. g. D. Cohen, and G. P. Morriss, *Phys. Rev. Lett.* Vol. 71, 2401 (1993). In 2002 Evans and his colleagues experimentally demonstrated the proof of this theorem in rigorous fashion. See G. M. Wang, E. M. Sevick, Emil Mittag, Debra J. Searles, and Denis J. Evans, "Experimental Demonstration of Violations of the Second Law of Thermodynamics for Small Systems and Short Time Scales," *Phys. Rev. Lett.* 89(5), 29 July 2002, 050601. The proof also directly proves the

occurrence in electrolytes and fluids of time-reversal zones (TRZs) where the dynamics runs backwards for a short time. This validates Bearden's proposal of the TRZ and its consequent reversal of the Coulomb barrier to a Coulomb attractor as the mechanism producing attraction of like charges into quasi-nuclei, which then can decay by quark flipping (if necessary) as the TRZ decays and reverses back to normal. This provides a mechanism for transmutation of elements in these TRZs as a result of the fluctuation theorem and its proof by Evans et al.

**flux:** The amount of some quantity (such as energy, particles, volume of fluid, etc.) flowing across a given area (usually a unit area perpendicular to the flow) per unit of time. The term flux density is now more commonly used. Loosely, "flux" refers to the perpendicular flow through an area, while "flux density" refers to the magnitude or intensity (rate) of the flux. In some cases such as a flux of particles of different velocities, the number of particles may be multiplied by the average velocity to give an average flux density that is weighted.

**flux density:** The amount of some quantity (such as energy, particles, volume of fluid, etc.) flowing across a given area (usually a unit area perpendicular to the flow) per unit of time.

**Fogal semiconductor:** A special semiconductor invented by Bill (William) Fogal which, in its operational regime, utilizes an integrated semiconductor, very special tantalum capacitor, and feedback resistor to accomplish charge blocking (blocking of electron current flow  $dq/dt$ ) while passing displacement current  $d\phi/dt$ .

The Fogal semiconductor can also accomplish amplified phase conjugation of signals as well as infolding (translation of input transverse EM waves to output longitudinal EM waves) and unfolding (translation of received input longitudinal EM waves to output transverse EM waves). Used in communication systems, it opens the use of the unlimited "infolded" electromagnetics bandwidth. Since it may communicate using longitudinal EM waves, it is also usable for superluminal or a specialized "tunneling" communication through the "interior" of normal EM waves, potentials, and fields. For example, it can easily transmit color TV signals through the "interior" of a common DC potential. See William J. Fogal, "High Gain, Low distortion, Faster Switching Transistor," U.S. Patent No. 5,196,809, Mar. 23, 1993; - - "High Gain, Low Distortion, Faster Switching Transistor," U.S. Patent No. 5,430,413, July 4, 1995, a continuation of his earlier patent.

**Fogal, William:** Researcher and inventor of the Fogal semiconductor (two patents so far), as well as a superluminal infolding-outfolding communication system and other remarkable longitudinal EM wave processes. The Fogal semiconductor allows the use of the internal longitudinal wave electrodynamics comprising all ordinary EM fields, waves, and potentials, and thus will usher in a revolutionary new communications science and extended electrodynamics technology. See also discussion under Einstein's second postulate extended.

force: In mechanics, identically the time derivative of momentum, or  $\mathbf{F} = \partial/\partial t(m\mathbf{v})$ . One must realize that it is not the mass in motion, but the single undivided quantity "mass-motion" or "mass-velocity" (momentum) that is changed. Present EM theory erroneously takes force fields to exist in empty, massless vacuum but with zero force! However, the mechanical definition is an identity, not an equality. The observable mass in vacuum is zero, so substituting  $m = 0$  gives  $\partial/\partial t(0 \cdot \mathbf{v}) = 0$ . This appears to be the conventional reasoning. However,  $\mathbf{F}/q = \mathbf{0}/q = \mathbf{0}$  also. So if mass is zero, the field  $\mathbf{E}$  used in "force field definition" disappears. All that says is that the field in mass-free space and the field in mass are totally different entities,

**Since force** can be induced into and of the mass-motion target at a distance, in the new approach there is a more fundamental mechanism that produces force itself, and that is a curvature of spacetime, in agreement with general relativity. Distant curvatures of spacetime to produce forces on exposed charged mass systems may also be engineered by longitudinal EM wave interferometry, which does constitute "action at a distance." The fields arise in the local spacetime in the distant interference zone, thus arising from within and around any physical mass object located in that zone. Hence it produces an "inside-to-outside" type of action that is presently unknown in orthodox physics. The produced fields can start inside the nucleons of the atoms and move outward, and work directly upon the quarks and gluons first. This opens a great number of entirely new nuclear reactions presently not developed in particle physics.

**force field:** An 3-space *effect* that exists as a local vacuum virtual particle flux **interaction** upon and with a hypothetical unit point mass or unit point charge assumed at every point in 3-space. The effect (force field) results from a *causal* force-free 4-field (a curvature of spacetime) interacting with an observed hypothetical unit point mass or unit point charge assumed at every point in space. Hence the invocation of observation invokes a  $d/dt$  **operator** (the interacting charged mass) upon the causal field, providing a

frozen 3-snapshot of the ongoing 4-interaction. An iterative series of such 3-observations is said to constitute a "3-space force field" as if it existed in time, which it does not. It is seen (iteratively observed) as a series of such frozen snapshots, which mentally we conceive as "existing in time" instead of the "recurring at points in time" that it really is. We unconsciously invoke that substitution of iterative effect as being continuity in space and time, when we use terms such as "propagation through space".

**force-free propagation:** Propagation of force-free disturbances in the vacuum flux; i.e., propagation of curvatures of spacetime or sets of such curvatures, together with any associated dynamics.

**foundations of mathematics:** The concepts, operations, assumptions, postulates, logic, definitions, and axioms of algebra systems.

**foundations of physics:** The postulates, assumptions, concepts, and definitions upon which a scientific physics model rests. Included are also the postulates, concepts, assumptions, definitions, axioms, logic, and operations of the mathematics in which the scientific model is expressed, as well as the postulates, concepts, assumptions, definitions, and operations of the physics entities and functions assigned to the mathematical symbols. Thus "scientific truth" — even mathematical truth; see Morris Kline's *Mathematics: The Loss of Certainty* — is actually a *qualified* truth. What is true in one model (one set of postulates, assumptions, concepts, and definitions, including those in the algebra) may not be always true when one or more of the postulates, assumptions, concepts, and definitions is/are changed, and/or when the topology of the mathematics in which the model is expressed is changed, etc.

**four-space (4-space):** The "normal" spacetime used in physics, consisting of three spatial dimensions and one time dimension. Minkowski spacetime.

**fourth law of logic:** The law that a thing and its opposite become identical on the boundary, i.e., in multiple simultaneous observations. *Identity* is merely the loss of observational or perceptual distinction; when formerly "two" objects are simultaneously observed by a single observer, and two slides have been shown at once in the slide projector. It does not matter at that point what each was individually observed to be before when it was singly observed. Now there is no observable distinction or difference. We previously showed that the fourth law is implicitly assumed in the three laws of Aristotelian logic anyway, and published a simple proof of the fourth law. Without the fourth law, Aristotelian logic "eats itself." As a simple example, the Aristotelian third law eliminates the center vertical line division of a simple Venn diagram between A and not-A, because the

division line itself is happy to belong to both A and not-A simultaneously. So Aristotelian logic destroys the very Venn diagrams used to "prove" or "demonstrate" its logical propositions. What results in the four law logic is that either (1) the three laws apply explicitly and the fourth law applies implicitly, or (2) the fourth law applies explicitly and the three laws apply implicitly. This *application rule* — i.e., *either (1) or (2)* — itself can be taken as a fifth law of logic, thus extending and completing Aristotelian logic which is presently incomplete. The fourth law is also the law of the **paradox**: i.e., when something is true but violates one or more of the Aristotelian laws, it is a case where the fourth law applies explicitly and the three laws apply implicitly. Wave-particle duality is such a fourth law case.

**four-wave mixing**: A nonlinear multiwave mixing effect when four waves mix (interact) in a highly nonlinear situation so that wave-to-wave interaction occurs.

**fractional charge**: A hypothetical particle having a charge less than the electron's charge. Often called a quark, where its charge is  $1/3$  or  $2/3$  the charge of the electron. A few years ago, Stanford University researchers found what was believed to be evidence of free quarks, but that later was doubted. There is also now the fractional Hall effect. In the 1920's Ehrenhaft reported the discovery and production of fractional charges of all sizes, and his experiments have been replicated by Mikhailov, with papers by Mikhailov and Barrett.

In the new approach, when time-energy is utilized, quarks can be freed or nearly freed rather easily in matter inside "time-reversal zones", since the energy emerges from the local curved spacetime and propagates from within **the** nucleus outward and the gluon forces are substantially reversed.

Note also that time is multiply connected, and energy can enter an object anywhere within it or even everywhere within it, since each and every differential piece of the object exists in every single increment of time. It would appear that, as the new approach develops, free quarks will become a normal event rather than one intensely sought but terribly difficult to come by experimentally. We flatly predict that, in a sufficiently good time-reversal zone, free quarks can be produced because of the enormous energy density (in the time component) being utilized.

**frame, Lorentz**: A frame of reference that is not accelerated with respect to the laboratory observer. In this case, the frame may be rotated (moving at a constant velocity) but it is not rotating (the frame is not accelerated with respect to the observer, and spacetime is not curved). In this case

special relativity applies, as do the conservation laws. We do add a caution that full general relativity still applies to the interior structure and dynamics (the engine) comprising the flat spacetime. Two *overall* flat spacetimes may produce very different interactions inside matter, if their internal engines are materially different and dimensioned.

**frame, reference:** A spatial, organized, measured lattice placed in "emptiness" (space, spacetime). Normally refers to a 3-dimensional, spatial frame (simplest case) or to a 4-dimensional spacetime. All objects and points in the "universe" or spatial frame are considered to simultaneously coexist at separate, measured points in the frame. Differs from the vacuum in that, rigorously, vacuum has no existing definite lengths and no existing definite time intervals, as these appear only after measurement or detection, and are relative to the observer and to the interactions ongoing as well as in the detection process itself. The "laboratory frame" is the static reference frame of the observer or measurement. A separate reference frame may be assumed to exist for any fixed or moving object, or centered on any point in another frame. When a type of frame is assumed, the entire class of *translation type* physical interactions that can occur has been restricted to an assumed set or type. In other words, given the frame, the *conventional* physics of translation has been assumed. One of the greatest restrictions of an assumed "frame" is to rule out the consideration (existence) of other higher dimensions, hence of dimensioned engines.

In the new unified field theory approach, the other higher dimensions are always available and cannot be ruled out in general, but only in some special case. Every curvature of spacetime, and any internal additional curvatures comprising that primary curvature, *adds one or more new dimensions*. In our view, a spacetime may be "flat" in overall envelope curvature, but consist of internally structured deterministic curvatures or "engines". In this view, normal inertial frames, e.g., may still contain engines, which will not affect the normal *bulk translation* rules, but may affect any or all of the nontranslation mechanisms, including the very laws of nature in many cases. Engines have not been developed and used in conventional open physics, but were weaponized clandestinely by the former Soviet Union. See **Einstein's second postulate extended**.

**free energy:** Excess energy freely received from its external active environment by an open system that is far from thermodynamic equilibrium in its exchange with that environment. There is a separate thermodynamics for such open disequilibrium systems. (See **thermodynamics of open systems**. See also Appendix A for a more

detailed discussion of the thermodynamics aspects). Such a system is permitted to exhibit five "magic" functions: it is permitted to (1) self-order, (2) self-oscillate or self-rotate, (3) output more energy than the operator himself inputs (the excess energy being freely received from the active environment), (4) power itself and its load simultaneously (all the energy being freely received from the active environment), and (5) exhibit negentropy. Every charge and dipole in the universe already performs all five of those functions.

**free energy** system: Any open system not in thermodynamic equilibrium, which freely receives excess energy from an external environmental source, **and** collects and utilizes this free excess energy to freely power external loads, so that a permissible system  $COP > 1.0$  is achieved, as allowed by the nonlinear thermodynamics of open systems in disequilibrium with their environment. (See **thermodynamics** of open systems.). A free energy system may also be "self-powering" if "close-looped" with governed positive energy feedback from output section to input section, meeting the Kron self-powering condition. Operation of free energy systems can only be properly modeled and understood in terms of their *supersystem* interactions.

Implicit in the notion of free electromagnetic energy systems are six key concepts: (1) the local vacuum/spacetime is known to be filled with hidden (i.e., virtual) energy in violent motion, i.e., the local vacuum/spacetime is a violent virtual energy flux and therefore a scalar potential, (2) a broken symmetry - i.e., some sort of organizing and gating mechanism, such as the common dipole — in this hidden (virtual) energy flux of the vacuum is utilized as a source, to cohere the virtual energy and divert it as energy  $S = f(\mathbf{E} \times \mathbf{H})_w$  from the broken symmetry initiation point onto the external circuits or load parts of a device, (3) the coherent gated extra virtual energy flow available in the external circuits or load parts couples to (interacts with) the mobile charges in those circuits or load parts, so that gradients developed in the interacting virtual flux form force fields on and of the particle masses, driving the mobile charges along the circuit and through current-impeding circuit components such as loads, (4) in the interaction of the driven charges with the driving virtual energy flux, their spin and erratic motions integrate a tiny "coupling fraction" of the driving virtual energy into observable (i.e., macroscopic field) energy, thus creating the **E**-fields and **B**-fields, (5) the current-impeding external components or load parts scatter or dissipate the coherence of the driven charges and thereby dissipate the collected energy or change the form of the **collected field** energy, thereby producing useful work, and (6) little or



none of the excess collected energy in the circuit is split off and dissipated in the gate (asymmetry component serving as the S-flow source) to destroy the gate and thereby destroy its asymmetry in the vacuum flux, which is what is extracting and producing the free energy flow.

**gate:** A component or function that extracts some part of a flux or flow, compacting it into a stream, and "sending it out" in organized, useful energy flow form. The fundamental gate for all EM energy in 3-space is the dipole or dipolarity — the "isolated charge" is actually a dipolarity, when the virtual charges of opposite sign clustering around it in the active polarized vacuum are considered. The source of the 3-space EM energy continuously emitted by any charge or dipole is an equal inflow of EM energy from the complex plane (from the time domain). Thus EM energy flow is locally conserved in four dimensions as a 4-circulation, but not in 3-space. EM energy flow in 3-space is conserved over all space, since there are essentially equal amounts of positive and negative charge in the universe and in the virtual charge of the vacuum.

**gauge:** In electromagnetism, usually considered a possible choice for (change of) electric scalar potential and magnetic vector potentials, in such a manner that there is no *net* change of force fields so that the change satisfies Maxwell's equations. There are indeed two changes of force fields, but the two are selected so that the two new force fields are equal and opposite, constituting a stress potential and continuously performing internal work on the system to create and maintain the excess system stress. The equal and opposite force fields, however, cannot translate electrons through loads to freely power them. We prefer to consider any change of potential — even a single potential changed, or both changed so that a net force field does result — as a "regauging", for it is an implied primary assumption *within the normal use of the term "regauging."* If only one potential is changed, a net force field results in the system and we call that "asymmetrical regauging". If both potentials are changed, but in such a way that a net force field still results, that is also an asymmetrical regauging. When both potentials are changed precisely in such highly selected manner that the two force fields created are equal and opposite, the force fields sum to a *translation* vector zero, and that is symmetrical regauging or *Lorentz regauging*. However, the energy of the two fields remains, having been transposed to a stress potential. Each of the two "balanced" equal and opposite force fields is continuously performing work in the system, but all that is created is additional system stress. Hence symmetrical regauging is obtained only by altering the stress and stress energy of the system, with two disequilibria in energy flow between

the **external** environment and the system. This in fact constitutes both a curvature of the local spacetime and an alteration of the local active vacuum. It is a rotation of the frame of the regauged system out of the **laboratory** frame. In effect, the net EM field energy of the two new fields created by symmetrical regauging is transformed into a change in the local spacetime curvature, a change in the local vacuum, increased stress in the system, and rotation of the system's frame away from the lab frame. We focus upon the energy aspects, since in a system any change of potential - whether symmetrical or asymmetrical — is a change of the internal energy of the system, and therefore of its excitation. In a system, conventional "symmetrical force fields" regauging results in a *nonusable continous* energy change in the system (actually two of these changes), and a change in the internal stress of the system. In short, it is a special case of **adding** a *stress potential* to the system, which we consider a special form of *asymmetrical regauging of the supersystem* consisting of (i) the system and its dynamics, (ii) the local active vacuum and its dynamics, and (iii) local spacetime curvature and its dynamics.

gauge freedom: The axiom in gauge theory that one can freely change the gauge (**and** therefore the potentials and the potential energy) of an EM system, so long as the net new forces resulting from the change will sum to a zero **vector** resultant so that the system remains "symmetrical" in its **force-field** functioning with respect to the system prior to the change of potentials. Electrodynamacists do not seem to have recognized that the freedom to change the potential of a system at will, is *a priori* the freedom to make a purely negentropic change to increase the system's potential energy, or a purely entropic change to decrease the system's potential energy. Gauge and gauge freedom are actually formal restrictions of an even more important asymmetrical regauging principle: *a potential in a system can be freely changed at any time, thus freely changing the potential energy of the system freely and at will*. The additional symmetry assumption is an arbitrary added requirement not imposed by nature.

Further, it appears that physicists have not recognized that a longitudinal EM wave is an oscillating gauge varying in its magnitude. Said in reverse, oscillating *the Lorentz regauging condition for a circuit makes that circuit a generator and emitter of longitudinal EM waves*. This also provides a clue for detection of longitudinal EM waves, similar to what occurs in a Fogal semiconductor used for that purpose. A longitudinal EM wave detector must detect a variation in the symmetrical regauging condition, which is a stress change detection.

**gauge symmetry:** Abstract mathematical symmetry of a field, that relates to the freedom to regauge (change the value of) potentials, without affecting the *net resultant* values of the field quantities. This is a special case of the higher principle that any potential (and thus the potential energy of a system) can be changed freely and at will. However, changing the gauge of an EM system in that sense changes the potential energy of the system but *only in stress potential fashion*. In other words, it does nontranslating work on the system, which is called "internal work." The lack of a net resulting force in the system, created by the regauging symmetry, prevents use of this excess free energy to translate system charges and power an external load. All the excess free energy that could otherwise be used to power loads freely, is instead "locked up" to only perform internal work on the system to increase and maintain system stress.

**gauge theory:** A field theory using a field that has one or more gauge symmetries. The restriction to symmetry is a carry-over of the old erroneous notion that potentials are just convenient mathematical figments, and that fields are the primary causes of all EM phenomena. For the overunity researcher, broken gauge symmetry at a given level (usually in 3-space EM energy flow) is the feature that must avidly be sought in experimental systems if one would use asymmetrical regauging to allow free powering of loads. Hence one is primarily interested in a wide variety of *broken symmetry effects* and phenomenology. Particularly, unless the automatic self-enforcing of symmetrical gauge transformation during excitation discharge of the closed current loop system is violated, no EM system can produce  $COP > 1.0$ . Further, local spacetime curvature between local input and local output is always involved in an overunity EM power system. The tempic (time) potential of the output end of an overunity system differs from the tempic potential of the input end, so that the gradient (the tempic force) is directed from output to input — exactly the reversal of the case for a  $COP < 1.0$  power system.

Thus in both  $COP < 1.0$  systems and  $COP > 1.0$  systems, a local spacetime curvature is involved when the system is in operation. In  $COP < 1.0$  systems, the tempic force sweeps along from input to output and on into space beyond, where the violent interactions of vacuum absorb the associated Dirac sea hole current immediately. In  $COP > 1.0$  systems, the tempic force sweeps along through the local vacuum from the output section back through the system and into the input section, and thence on back through the external conductors to the external power source. This reversed Dirac sea hole current may "eat electrons" in the normal currents

**internal** to the system, and in the input section and back towards the external power supply it will "eat input electrons in the input current."

Thus the Dirac sea hole current in the  $COP > 1.0$  system "eats input power" and serves as a curious new kind of electrical "load" or "internal loss" in the **input** section of the system. The reversed Dirac sea hole current is

nature's way of decaying the local curvature of spacetime back to a flat spacetime, and decaying the  $COP > 1.0$  excited system disequilibrium state back **to an** equilibrium state. In any overunity electrical power system, this

Dirac sea hole current must be taken into account and either transduced into useful power, minimized, or eliminated. An extension to gauge field

theory is needed in which the tempic force, the tempic potentials and their gradients, and the supersystem are all modeled and taken into account. It

appears that the Sachs unified field theory is capable of handling that **requirement**, which also can be accommodated by  $O(3)$  electrodynamics to provide engineering of the resulting unified field theory.

**gauge transformation (in electromagnetics):** Conventionally taken to be the **addition** of the gradient of some function of space and time to the

**magnetic** vector potential—and simultaneously the addition of the negative of the partial derivative of the same function with respect to time, divided by the speed of light, to the electric scalar potential. The resulting **symmetrical** change assumes that the stress energy of the system is changed **freely**, but by design it deliberately prevents any stress difference in the system to produce a net force that could expend the free change of energy by doing work in an external load. Changing the stress energy alone is a curvature of spacetime and a purely gravitational change. It is also a **rotation** of the frame of the system away from the laboratory frame. See discussion under gauge theory.

**general theory of relativity:** Einstein's theory of gravity in which the gravitational force is represented by a curvature in spacetime, and in which spacetime is an active entity. We may look at all forces as being due to curvatures of spacetime interacting with mass.

**geometric phase:** A phase difference acquired by the state function of a quantum system that undergoes a cyclic evolution from an initial state and back. This phase difference can be detected by interfering the final and initial **states**. The modern generalization of the Aharonov-Bohm effect and the Berry phase.

**giant negentropy (of the dipole):** The continuous receipt from the time domain of **spacetime** (the vacuum), by one charge of any dipolarity (including a single charge's fundamental dipolarity), of enormous

longitudinal EM wave energy flow in condensed time energy form, transduction of that absorbed energy from the complex plane into real 3-space, and continuous emission of that enormous energy flow in all directions in 3-space, thence receipt of that 3-space energy by the other charge of the dipole or other adjacent dipoles, retransduction of the energy back into time-energy, and re-emission of that energy back into the time domain. This 4-circulation giant negentropy process is evoked and continues automatically and indefinitely after a little energy has been expended to separate the charges and make the source dipole. The EM waves in the input from the time domain and the output in 3-space are perfectly ordered and correlated, which is a giant ordering of the vacuum/spacetime and is thus a giant negentropy. In conventional circuits, the source dipole in the generator or battery, once made, performs this function. Only a minuscule fraction (some  $10^{-13}$  in a nominal case) of the energy pouring out of the generator's or battery's terminals strikes the surface charges of the attached external circuit and is diverged into the conductors as the Poynting component that powers the Drude electrons and the circuit. All the rest of the energy flow (the Heaviside nondiverged component) outside the circuit is just wasted by conventional circuits.

**gluon:** A particle that carries the forces between quarks. In quantum chromodynamics, the gluon plays a role analogous to the photon in quantum electrodynamics.

**graviton:** In the quantum theory of gravitation, the graviton is the quantum of the gravitational field. It is massless, with spin 2. In the new theory we may take the graviton as a coupled scalar and longitudinal photon pair.

**gravity:** The phenomenon characterized by the physical attraction between any two material bodies of positive mass, specifically due to the trapped positive energy in the masses. If one particle is of negative mass and energy, the normal gravitational attraction between the two particles is reversed so that they repel, which produces antigravity. The fundamental mechanism of gravity can be found once one realizes that Maxwell omitted the incoming EM wave interaction with the nucleus, and not with just the electron shells. When he wrote his theory, the electron, atom, neutron, proton, and neutron had not been discovered yet. The lateral precession movement of the spinning Drude electrons — which are restrained *longitudinally* to a very small drift velocity in detecting wires (antennas) — later came to be considered proof of Maxwell's transverse EM wave in the vacuum. The detected electron precession wave is oscillating laterally, hence proves the longitudinal EM wave interaction. Elsewhere we have

pointed out that the EM wave in space is longitudinal EM wave accompanied by a corresponding time-polarized (scalar) EM wave, and it also follows from Whittaker's 1903 paper as reinterpreted by the present author in our Giant Negentropy paper.

**gross particle translation:** Refers to translating the entire particle — and its internal structures and dynamics — in space, rather than internally structuring the particle's potential (massless charge). Note that, if the internal structuring (engines) of the particle is changed during translation (e.g., by passing through a region of the flat spacetime having an altered internal engine structure), the particle may have an anomalous interaction with another particle or process having a different internal structure or "dimensioning." The mass-energy comprising the particle's nucleus, electron shells, etc. can be dimensioned. Mass so dimensioned or conditioned then may act differently in chemical reactions, effects on living systems, etc. than normal "inert" mass that has no specific deterministic dimensioning.

**group:** A mathematical structure that is a complete set of transformations on a mathematical entity that leaves the entity unchanged.

**group, higher symmetry:** In a given theoretical area, a particular theory can be expressed in various group transformations. When the group transformation (group symmetry) utilized is more complex than the "standard" group symmetry usually employed, it is referred to as a *higher* group symmetry. The mathematics of the model is then said to be a higher group symmetry mathematics. Since the groups have names such as  $U(1)$ ,  $SU(2)$ ,  $O(3)$ , etc., the transformations of the mathematics are often referred to by **those** names. Hence characterizing phrases are used such as  $U(1)$  symmetry electrodynamics,  $SU(2)$  symmetry electrodynamics,  $O(3)$  symmetry electrodynamics, etc.

**group, Lie:** A group whose transformations act continuously. An example of a Lie group is given by rotations in ordinary space.

**group theory:** The general mathematics of symmetry transformations; i.e., the **theory** of all transformations that leave the transformed entity or entities unchanged.

**gyroelectrons:** Spinning electrons considered as gyroscopes during the portion of their spin in 3-space, so that when longitudinally perturbed they can and will laterally precess. Considering (in a gross first order model) the conduction electrons in the Drude gas in a conductor as little gyros, because they are (i) spinning on an axis, (ii) severely restrained in their

ability to move forward longitudinally down the conductor as current, and (iii) much more free to precess laterally in the conductor. Thus when the gyroelectrons in the receiving wire antenna, perturbed by an incoming longitudinal EM wave in the vacuum, are longitudinally perturbed, they precess laterally so that our instruments (which detect electron wiggles, not the incoming vacuum EM wave) do detect "transverse waves." However, they are detecting the transverse gyroelectron precession waves, not the waves in the vacuum. They are detecting the *effect* of the interaction of the incoming waves with the gyroelectrons, not the *cause*.

harmonic series: A set of frequencies or oscillations consisting of integer multiples of a fundamental frequency.

Heaviside, Oliver: Noted English self-taught physicist and brilliant electrodynamicist, 1850-1925. who played a role in discarding Maxwell's quaternions, and also played a role in forming vector mathematics and formulating the vector reduction of Maxwell's theory from 20 quaternion equations in some 20 unknowns to the present 4 vector equations. Heaviside's curtailment of Maxwell's theory still contained both (i) systems in equilibrium with their active environment and (ii) systems in disequilibrium with it. To separate variables and enable closed solutions, *Lorentz* further curtailed the Maxwell-Heaviside equations by symmetrically regauging them, thereby *arbitrarily* discarding all disequilibrium Maxwellian systems and retaining only those in equilibrium with their active environment. This regauging unwittingly and erroneously discarded all that class of Maxwellian systems permitted to exhibit  $COP > 1.0$ . The first such curtailment of the Maxwell equations was by Ludwig Valentin Lorenz in 1867, but H. A. Lorentz (who did a similar symmetrical regauging nearly decades later) was later given the credit.

Heaviside also discovered the enormous *nondiverged* energy flow surrounding every circuit, far greater in magnitude than the feeble Poynting *diverged* component that actually enters the circuit. But he was at a loss to explain what the source of such a startling flow of energy could be. Lorentz understood the Heaviside component, but also could not understand its source. Hence he reasoned that it "had no physical significance" since it did not power the circuit. Lorentz then introduced the trick of integrating the entire energy flow vector around a closed surface surrounding any volume element of interest. This neatly discards the vexing giant Heaviside *nondiverged* energy flow component, and retains only the *diverged* Poynting component that actually enters the circuit. The latter is of course the energy that will later be *emitted* from the circuit, which is what we will measure when we "measure the circuit."

Electrodynamists are still using this method of dropping the Heaviside energy flow from any further accounting consideration. Hence they do not develop systems which intentionally increase their energy collection from this readily available energy flow around every circuit. The Bohren experiment conclusively proves the physical existence of the Heaviside nondiverged component, even though it is no longer accounted.

In his last years Heaviside realized the gravitational importance of his extra energy flow component, and worked out an electrogravity theory based on it. He did not live to publish it, but his papers on it were found some time after his death, beneath the floorboards of his little garret apartment. A learned society then published the papers.

Heaviside energy flow component: The enormous *nonintercepted* and *nondiverged* energy flow component pouring out of the terminals of every battery or generator, or charge or dipole, and missing the external circuit (or external intercepting charges) entirely so that it does not contribute to the intercepted (Poynting) flow component that powers the circuit. Also, the enormous energy in the EM field, potential, or wave that misses the interaction of the field, potential, or wave with the assumed unit point static electric charge, and thus is not intercepted and collected (and accounted!) in the unit point static charge assumption. In honor of Heaviside, the present author has nominated this "dark Heaviside energy" component as the missing source of excess gravity known to be holding the arms of the spiral galaxies in place. In the interactions of Dirac hole current with a unit point charge (to determine the negative energy fields and potentials in a  $COP > 1.0$  EM system), there is also a missing component of the negative energy flow that is comparable to the Heaviside component for positive energy flow. These flows of surplus negative energy from  $COP > 1.0$  astronomical interactions—with the associated negative energy fields and negative energy potentials produced by the **negative-energy** Dirac holes in these negative energy flows—is hypothesized by the present author as producing the antigravity that generates the observed acceleration of the expanding universe.

**Hertz, Heinrich:** Noted German physicist, 1857-1894, who together with Heaviside and others transformed Maxwell's theory from quaternion algebra to vector algebra, and who also experimentally produced Hertzian (EM) waves, thus confirming Maxwell's theory. These experiments by Hertz first detected EM energy propagating as described by Maxwell's equations, thus providing the experimental impetus that allowed Maxwell's theory to predominate. The oscillation or "cycle" is named after Hertz, by



specifying  $X$  number of oscillations or cycles per second as a frequency of  $X$  Hertz. One type of potential is also named after him.

**hidden bidirectional EM waves:** Those bidirectional EM wavepairs that comprise the scalar potential are indeed "hidden" with respect to our normal "electron translation" (i.e., electron wiggle) detectors and instruments. Nonetheless, properly functioning devices such as Fogal's semiconductor allow the utilization, transmission, and reception of the vast longitudinal EM wave dynamics that are infolded inside all conventional EM fields, waves, and potentials, including the giant potential comprising the ambient vacuum (spacetime). Use of this infolded electrodynamics is akin to using "subspace" or higher dimensions, depending upon how one chooses to model it mathematically. It is also a direct method of using a unified field theory.

**hidden variable theory:** A class of quantum mechanical theories which considers that the quantum state of a physical system is not a complete specification after all. The "hidden variables" are those additional components necessary to provide the "complete state" of the system. By utilizing the infolded longitudinal EM wave electrodynamics, one is in fact using a macroscopic hidden variable theory. This becomes a subset of Evans'  $O(3)$  electrodynamics, which in turn is an important subset of Sachs' unified field theory. Sachs' theory encompasses and subsumes electrodynamics, general relativity, quantum mechanics, etc., so the use of this macroscopic hidden variable theory through special functions provided by components such as Fogal semiconductors is a powerful and directly engineerable extension of conventional hidden variable theory. The physics of this new, engineerable, unified field theory area is also called *energetics*.

**hole, lattice:** Vacancy, in an otherwise filled energy band position. Sometimes called *negative ion vacancy*. In a semiconductor, an electron may be lifted to the conduction band by thermal energy, which produces a hole-electron pair (an exciton). Also, one of the sites in the crystal lattice can be occupied by an acceptor impurity atom, so that the electron is accepted there, leaving a hole showing excess positive charge. This is a lattice hole, and the propagation of such holes being formed is called electron hole current, or hole current for short. We point out that the *lattice hole* exists only after interaction of the Dirac sea vacuum hole with matter. i.e., only after observation. In that case, the 3-positron (hole) has positive mass and positive energy, produces positive energy fields and potentials, produces gravity rather than antigravity, and is "seen" to be going in the opposite direction to the Dirac sea hole. Prior to observation, the hole is a

Dirac 4-hole in vacuum, having negative energy and therefore negative mass equivalence, negative charge, and without a direction reversal. This 4-hole is a source of negative energy fields and negative energy potentials in the surrounding space, and thus of antigravity back-interaction (upon the physical system connected with the active vacuum component of its supersystem) due to the negative curvature of the local spacetime.

**hole**, Dirac sea: In the presence of fields (i.e., in the presence of curved spacetime), some of the negative energy states in the Dirac sea are not filled with electrons. In that case there are some empty 4-holes in the Dirac sea, in local spacetime itself. The Dirac hole is a negative energy state in the vacuum itself. It too *seemingly* has a positive charge, as seen by the external observer after interaction with matter. Holes are also mathematically equivalent to positrons, in case observation has been evoked, so long as the lack of positive mass is not a consideration. Note that our view differs from the received view, but is based on experimental evidence which can only be gained from COP  $\gg$  1.0 EM system experiments. We know of no such COP  $\gg$  1.0 EM system experiments involved in the received view.

**hole current:** (1) In a semiconductor: Usually, the part of the current in a semiconductor that is composed of migration of lattice holes.

*Mathematically*, within certain constraints this may be considered a positron current. The hole migration is usually slower than the electron migration producing electron current. (2) In the vacuum itself. In the *Dirac sea*, in the presence of fields the Dirac 4-holes flow in the opposite direction to the local electron current, providing a Dirac sea hole current or positron current. [See discussion under hole.] An electrical power system in disequilibrium with its vacuum interchange and having COP  $>$  1.0, will have a **greater tempic potential** at its output section than at its input section. Thus it will have a tempic force or tempic broom, sweeping holes from local instabilities to form a hole current (may be both a Dirac sea hole current and a lattice hole current) flowing from the output section of the system back through the system into the input section, and on out of the input section into the primary power source. *Hole current transduction may be used to convert this detrimental hole current energy transport into usable electron current energy transport, or anti-circuit techniques and mechanisms can be used.*

**hole current transduction:** Hole current in a COP  $>$  1.0 open system, where the system is in disequilibrium with the vacuum *a priori*, is usually detrimental to the system and may destroy the overunity condition. A hole current from the input section of the system, fed back into the primary

power supply, requires that extra electron current be furnished since some of the electrons in that furnished current will recombine with the oppositely moving Dirac vacuum holes and disappear to fill those holes. Hole current into a battery in "normal" fashion discharges the battery rather than charges it (although reversing the battery terminal connections allows charging in normal fashion using the hole current). Thus a battery can be discharged "far below zero", so to speak, by charging it with excess holes in the "normal connection." A capacitor may be charged with hole current, in which case the dielectric will undergo compressive strain into the positron-charged plate. However, when the capacitor is subsequently discharged, the dielectric will expand and recover, with its electron charges pushing electrons out of the negative side plate and into the external circuit. Hence a capacitor can be *charged* with positron (hole) current, and then can be adroitly switched so as to *discharge* electron current. In theory so can a battery because of its capacitance. This is a transduction of entropy to negentropy, a process for which a patent application has been filed by Bedini and Bearden. Gauge freedom already permits that operation, since gauging in electromagnetic systems is freely changing the local potential energy of the system, and is either negentropic (increasing the system's energy) or entropic (decreasing the system's potential energy).

**hole injection:** In an n-type semiconductor, holes can be emitted by applying a metallic point to the semiconductor's surface. We suspect (but have not proved) that sharp gradient pulses may also induce some of these holes as Dirac sea 4-holes and Dirac sea hole current rather than positron and lattice holes current. In that case, a mix of positive energy and negative energy (and gravity and antigravity) would be produced.

**hole trap:** An impurity in a semiconductor that can trap a "hole" by releasing electrons to the conduction or valence band.

**hyperspace:** Refers to a space of more than four dimensions, and specifically to those spatial dimensions outside the normal three. The term is used for both a space of  $n$  dimensions, where  $n > 4$ , or for one dimension in such a space, beyond the normal four.

**identity of opposites:** On the boundary between  $A$  and not- $A$ ,  $A$  and not- $A$  are identical (i.e., no difference can be discriminated). If all of a thing is collected, one reaches the boundary of that thing and it turns into its own opposite. The philosopher's problem of the "accursed necessity for the identity of opposites" cannot be solved in Aristotelian 3-law logic, since that logic is incomplete. It is readily solved, and part of, a more extended

logic such as 5-law logic. The result is that "identity" is not an absolute entity, but is a decision by the observer reached by application of a comparison algorithm to separate observations made at differing times. An example is provided by a colorblind observer who sees as identical two marbles which, to an observer with color vision, are seen as red and black and therefore not identical. Aristotelian logic omits the action by the observer, the times of the multiple observations (only a single thing at a time is observed or perceived, *apriori*), and the decision algorithm used *by the observer* to decide whether two observations are identical or not identical.

**inertial frame:** A frame of reference in which force-free bodies move along straight lines, and the postulates of special relativity are valid. In the new **approach**, this notion is extended. Even in an inertial frame, force-free **bodies** may move along straight lines, the postulates of special relativity may remain valid, and yet the EM hidden variables may induce other **changes** in the usual laws of nature due to the action of hidden vacuum engines infolded in the *dimensioned* local flat spacetime (vacuum **potential**). See Einstein's second postulate extended.

**infolded** real vector components: Simply take a set of real force vectors that altogether sum to a vector zero resultant. This "vector zero system" is a zero vector with respect to forced *translation* of a particle or mass. It is not an absence of the vectors at all, but is the presence of specifically hidden and "infolded" real vectors that do not initiate bulk translation of the **affected** object or system, but perform *internal* work upon the system. Such vector systems are stressing systems of a special kind, where the internal components of the stress are not random but deterministic. Hence they are electrodynamic *engines*, in the new approach. To a somewhat arrogant mathematical scientist who once objected that zero vector resultant systems had no effect, I humorously challenged him to put it to experimental test. I suggested he stand between two elephants pushing against him in opposite directions, while I would stand between two fleas doing the same to me, and we would compare notes. He apparently was not amused at the suggestion.

**infolding:** With reference to signals, infolding means "placing the signal **or modulation** or change upon one or more of the internal bidirectional wave **pairs** comprising the scalar potential. Since all EM potentials ultimately represent changes to the ambient vacuum potential, one has conditioned or altered the vacuum itself when infolding is utilized, infolding of EM signals, vectors, and directions produces *engines*. By Whittaker's decomposition of the potential and Bearden's reinterpretation,

these vacuum engines can be designed to affect matter — including atomic nuclei, nucleons, etc. — in any manner desired.

**information content of the field:** Russian euphemism for the deliberate structuring of the hidden longitudinal EM waves and their dynamics, that comprise any EM potential, field, or wave, so that the potential, field, or wave is *dimensioned* and contains active *engines*. This area was extensively weaponized under KGB (now changed in name) control rather than the regular Russian armed forces, and a disinformation campaign was waged to convince Western analysts that the term refers to simple spectral analysis. It doesn't. Instead, it refers to infolding and unfolding, and the use of longitudinal EM waves, dimensioning, and engines. The overall science is called "energetics" by those weapon scientists.

**interferometer:** An instrument or system in which a wave is split into two waves or beams, which after traveling over different paths are subsequently reunited and interfere. The use of longitudinal EM waves (LWs) allows ready penetration of mass by the LWs traveling through the interior Whittaker composition of a mass's internal EM fields, waves, and potentials. Longitudinal EM wave interferometers should prove useful in probing the interior of planets, the sun, etc. They pass easily through the earth, so that interferometry can be obtained at targets on the opposite side of the earth, or inside the earth. These are the weapons that then Secretary of Defense Cohen referred to in 1997 as being used to engineer the weather, initiate volcanoes into eruption, or initiate earthquakes.

**Josephson effect:** Flow of Cooper pairs (superconducting electron pairs) across a thin dielectric separating two superconducting electrons, in the absence of a voltage drop. E.g., the pair of electrons can "tunnel" through a thin insulating barrier.

**joule:** A measure of energy; one watt for one second in electrical terms. In physics the unit of work or energy in the MKS system, being the amount of work done by one newton acting through a distance of one meter, equal to 10,000,000 ergs.

**Kirchhoff's current law:** At any time, the sum of the instantaneous currents flowing into a node or point in a circuit equals the sum of the instantaneous currents flowing out of that node or point. This does not have to be true if (1) relativistic effects are appreciable, or (2) electron production and annihilation processes — such as Dirac sea hole current, lattice hole current and recombinations are occurring and non negligible, (3) the Kron open path is being used, or (4) localized time reversal zones (TRZs) are utilized. Another way of stating where the law need not hold is

when there are nonlinear interactions between the three components of the superset (the physical system and its dynamics, the active vacuum and its dynamics, and spacetime and its curvature dynamics.).

Kirchhoff's voltage law: At any time, the sum of all voltage rises in a closed loop circuit equals the sum of all drops in that closed loop circuit. The law assumes a flat spacetime. This does not have to be true if relativistic effects are appreciable, if true negative resistor effects are present, if Kron open paths are utilized, and if time-reversal effects are present. It also need not be true in anti-circuit techniques, or when they are involved in a particular portion of an otherwise normal circuit.

Lamb, Willis Eugene Jr.: American physicist and Nobelist who discovered the hyperfine structure of the hydrogen spectrum, and first measured the interaction of the vacuum energy that generates a change in the energy levels of the hydrogen atom, according to Dirac's theory and quantum electrodynamics.

Lamb shift: A very small correction to the first excited state of the hydrogen atom due to interaction of the vacuum. Willis Lamb experimentally confirmed this prediction of quantum electrodynamics to high accuracy. The local energy density of the little Lamb shift is greater than the surface energy density of the sun. However, in matter there are such a vast number of similar small interactions generating very powerful fields randomly, that the sum total of all these changes sums to a vector zero for most summation distances of interest.

lamellar current: Thin layers of current; thin sheets of current.

laser: A device that generates light in which all the photons are exactly in step and produce a coherent beam. Originally the word "laser" was an acronym that stood for "light amplification by stimulated emission of radiation."

law of physics: A restriction placed upon the physical mechanisms that can occur under certain broad assumptions as to the background situation and environment. Because of the assumptions made, an expressed law of physics is not absolute, but relative to the assumed conditions. Any "law of physics" can be violated if the conditions contained in its assumptions are violated. It is important that a scientist be aware that physics is comprised of models and the "laws of physics" are very general and wide-ranging models based on very specific assumptions. Further, by Godel's theorem and the theory of models, no model is perfect anyway, and none will ever be. When one assumes that physical laws are not based on any

assumptions but are universal and absolute truths, one has immediately moved to dogma and not science.

**Lawandy patents:** Patents covering and related to a form of anti-Stokes emission (excess emission of energy) in strongly scattering, optically active media such as  $\text{TiO}_2$  particles in suspension. This is a new form of lasing, without the requirement for population inversion.

**Letokhov, V. S.:** Russian pioneer in excess emission phenomena from stimulated media.

**Letokhov effect:** The excess emission (excess emission of energy) phenomena in strongly scattering, optically active media, usually referred to as "negative absorption of the medium." See particularly V. S. Letokhov, "Laser Maxwell's Demon," *Contemporary Physics*, 36(4), 1995, p. 235-243.

**localized:** Confined to a small region of a large system rather than being extended through the system or at a distance.

**localized virtual photon flux of vacuum:** Refers first to a local region of the vacuum, and then to the flux density of virtual photons in that local region. If that flux is deterministically structured, then the local region also contains an *engine* that will act internally upon masses and mass systems in that region. The local region also contains hidden variables.

**longitudinal component:** In EM fields, the longitudinal component of the fields along the direction of travel, as opposed to the transverse components at right angles to the direction of travel.

**longitudinal E-field:** Any electrical field in 3-space may be described using two components, a transverse component and a longitudinal component. Of course one or the other may be a vector zero. In 4-space, there is a time component also, as an additional "transverse" component.

**longitudinal gradient:** Compression wave gradients (differences) in density or pressure, considered in a direction from their origin along the direction of primary movement in the medium. Contrast to transverse waves, which act perpendicular to their direction of propagation. In electrodynamics, longitudinal EM waves in 3-space are said to be "longitudinally polarized." Longitudinal EM waves in the time-domain are said to be "time polarized." The latter are also referred to as "scalar waves" since they have no polarization vector component in 3-space and thus are "scalar" with respect to 3-space. This is a misnomer, however, since these "scalar waves" are perfectly good time-polarized EM longitudinal vector

waves. For the first time, the giant negentropy process allows one to make and use time-polarized EM waves, since they automatically accompany all longitudinally polarized EM waves and it is straightforward to make longitudinal EM waves in 3-space (just oscillate the Lorentz gauging condition).

longitudinal interior wave: An infolded longitudinal gradient that oscillates in magnitude along the line of travel "inside the vacuum potential or a normal potential." In conventional theory, the electric portion of the EM wave is a transverse field oscillation, and the longitudinal component is essentially zero. In the new "infolded" wave approach, there is no overall transverse gradient in the vacuum potential, but there are such longitudinal waves. This is rather like a "pressure wave" transmitted under water, without causing a surface wave involving physical upheaval and fall-off of the water. The speed of the longitudinal EM wave is not limited to  $c$ , the speed of transverse EM wave light in the ambient vacuum..

longitudinal wave: A "pressure" type of wave, similar to sound, in which the vibrations are along the direction of travel of the wave. Hence, a wave composed of alternating densifications and rarefactions, where we focus upon the longitudinal component of the changes. One can think of it as a sort of "accordion" wave, rhythmically shrinking and stretching along the line of motion as it travels. Note that rhythmically and symmetrically varying the two potentials involved in regauging creates longitudinal EM waves. So one pseudonym for longitudinal EM waves is "gauge oscillation" waves. Matter is mostly empty space filled with EM potentials, fields, and waves—all of which are bundles of longitudinal EM waves and their functional dynamics. Hence matter (such as the ocean and the earth) is a vast superhighway for the passage of longitudinal EM waves. Note that the longitudinal wave represents an oscillating energy density in space and/or time (scalar waves), and hence is an oscillating curvature of spacetime. All forces of nature are generated by curvatures of spacetime. Hence all forces of nature can be generated by the correct generation of longitudinal EM waves and their impressed dynamics. Further, this means that all the physical *causal* functions of the exhibited **effects generated** in a material system can be captured in longitudinal EM wavesets. A longitudinal wave functional system deliberately having such causal functions of a physical functioning system is known as a causal **system robot** (CASR). Such robots are far beyond the presently developing nanobots, and have been developed rather extensively by at least one nation. Such robots can easily pass through the "interior" of any normal



EM signal or wave or potential or field, which again is nothing but a giant superhighway for longitudinal EM waves. In theory one can communicate with a CASR via longitudinal EM waves if communications functions are built in to the CASR. In the future, one would expect that planetary exploration, underground and undersea exploration, exploration of the interiors of the sun, moon, and planets, could be enabled by the further development of specialized CASRs.

**Lorentz, Hendrik Antoon:** Renowned Dutch physicist and Nobelist. 1853-1928, who developed the Lorentz transformations and Fitzgerald-Lorentz contraction. Lorentz shared the Nobel Prize for discovering the Zeeman effect. He is also responsible for symmetrically regauging Maxwell's equations (some time after Lorentz did it in 1867), and for introducing an integration trick that neatly disposes of the vexing huge Heaviside nondiverged energy flow component accompanying every field/charge and potential/charge interaction.

**Lorentz invariance principle:** An inertial frame is independent of the velocity of the frame relative to any other inertial frame. This is not necessarily true with respect to engines inside inertial frame objects, since the engines involve acceleration dynamics.

**Lorentz regauging:** Changing the two potentials in the Maxwell-Heaviside equations in potential form so that the resulting equations have the variables separated, and there is no net force introduced by the two new forces, which are deliberately chosen so as to be equal and opposite and thus sum to zero. An unfortunate effect is that this discards all Maxwellian systems far from equilibrium in their vacuum exchange, hence discards all permissible Maxwellian  $COP > 1.0$  systems. Electrodynamacists have not recognized that Lorentz regauging represents the addition of stress potential energy and continuous internal work and stress to a regauged system. It also represents a rotation of the frame of that system out of the laboratory frame by some angle. Further, oscillating the Lorentz regauging condition produces longitudinal EM wave generation and emission.

**Lorentz symmetry:** The symmetrical regauging by Lorentz of Maxwell's equations.

**Lorenz, Ludwig Valentin:** Scientist who first changed Maxwell's equations — two years after their publication in 1865 — by (effectively) symmetrically regauging them, thereby unwittingly discarding all Maxwellian systems far from thermodynamic equilibrium with the active vacuum. See L. V. Lorenz, "On the identity of the vibrations of light with

**electrical** currents," *Philosophical Magazine*, Vol. 34, 1867, p. 287-301. In this paper [L. V.] Lorentz gave essentially what today is called the [H. A.] **Lorentz** symmetrical regauging. When H.A. Lorentz also symmetrically **regauged** the Maxwell-Heaviside equations, the physics community **adopted** the procedure and resulting further truncation of the Maxwellian theory. That truncation continues to this day.

low energy **nuclear reaction** (LENR): Actually a bit of a misnomer, since it refers to a low *spatial* energy, high *time* energy reaction. Cold fusion, or the anomalous transmutations of elements that occur in certain electrolytes with specially prepared palladium electrodes. The transmutations occur even though in conventional theory there is insufficient *spatial* energy to accomplish them, because they use time energy. Time energy is spatial EM energy compacted by the factor  $c^2$ , hence time has the same energy density as mass. The formation of temporary, fleeting time reversal zones (TRZs), with action from from inside-to-outside, is the genesis of a host of new nuclear reactions missing from conventional particle physics since the physicists do not account time as energy, and do not use such TRZs. For more on this hypothesis and the specific reactions generated, see T.E. Bearden, "EM Corrections Enabling a Practical Unified Field Theory with Emphasis on Time-Charging Interactions of Longitudinal EM Waves," *Journal of New Energy*, 3(2/3), 1998, p. 12-28 as well as Chapter 10 of the present book.

**magnetic dipole**: Paired north and south magnetic poles of equal strength ever microscopic or macroscopic distance.

**magnetic induction**: The act of a change in magnetic field producing an electric field at right angles, which in turn produces an electron flow.

**magnetic spin**: The intrinsic angular momentum, known as spin, of electrons, protons, and neutrons, etc. The electrons combined in an atom or ion have a resultant angular momentum that is the combined intrinsic spin of the electrons and the angular momentum due to their motion around the nucleus. There is also a magnetic moment associated with this angular momentum (spin) whenever it is nonzero. Therefore atoms or ions with nonzero spin are *magnetic* atoms or ions. This is often loosely referred to as "magnetic spin." It is actually the magnetic moment of nonzero spin.

**magnetostatic scalar potential**: Continuous mathematical function whose value in space, at any point it occupies, represents the potential energy collected upon an assumed unit magnetic north-seeking charge (pole).

There is a magnetostatic scalar potential between the poles of any magnet.

This scalar potential is **also** subject to **Whittaker's** 1903 decomposition into

a harmonic series of magnetic longitudinal phase conjugate wavepairs. Reinterpretation of Whittaker's wavepairs should be made according to Bearden, "Giant Negentropy of the Common Dipole," *J. New Energy*, 5(10, Summer 2000, p. 11-23. This reinterpretation agrees with quantum field theory; see Mandl and Shaw, *Quantum Field Theory*, Revised Edition, Wiley, 1993, Chapter 5.

**matter:** Highly condensed 3-spatial energy, compressed by factor  $c^2$  and remaining in 3-space, and with the observation process  $d/dt$  having been applied to the fundamental masstime entity to provide mass as a frozen 3-space snapshot by stopping the flow of time momentarily. Matter, of course, has internal structure, order and organization, and dynamics. All matter is in a continuous energetic exchange with its active vacuum (4-spatial) environment. Matter stripped of its EM fields, waves, and potentials is called mass. Mass is an observable and therefore a frozen series of continual 3-space snapshots, formed by incessant photon absorption to change the mass  $m$  to masstime  $mt$ , with following incessant photon emission to change masstime  $mt$  back to mass  $m$ .

**Maxwell, James Clerk:** Brilliant Scottish scientist, 1831-1873, who first formulated the unified theory of electricity and magnetism. See *The Scientific Papers of James Clerk Maxwell*, 2 vols. bound as one, edited by W. D. Niven, Dover, New York, 1952, Vol. 1, p. 526-597 for his definitive paper, "A Dynamical Theory of the Electromagnetic Field," first published in *Royal Society Transactions*, Vol. CLV, 1865. In that paper, (see Niven's book) his general equations of the electromagnetic field are given in Vol. 1, Part III, "General Equations of the Electromagnetic Field," p. 554-561. On p. 561, he lists his 20 variables. On p. 562, he summarizes the different subjects of the 20 equations, being three equations each for magnetic force, electric currents, electromotive force, electric elasticity, electric resistance, total currents; and one equation each for free electricity and continuity.

Maxwell's famous book, *A Treatise on Electricity and Magnetism*, Oxford University Press, Oxford, 1873, Second Edition 1881 (Maxwell was already deceased), Third Edition, Volumes 1 and 2, 1891. Foreword to the second edition was by Niven, who finished the work. Maxwell had dramatically rewritten the first nine chapters to simplify his mathematics because of the resistance to it, with much new matter added and the former contents rearranged and simplified. Maxwell died before finishing the rest of the second edition. The rest of the second edition is therefore largely a reprint from the first edition. The third edition edited by J. J. Thomson was published in 1892, by Oxford University Press, and later was published unabridged by Dover Publications, New York, 1954. J. J. Thomson

finished the publication of the third edition, and wrote a "Supplementary Volume" with his notes. A summary of Maxwell's simplified equations are given in Vol. II, Chapter IX of the third edition. However, Maxwell had gone (in his second edition) to some pains to reduce the quaternion expressions himself, and not require the students to know the calculus of quaternions (so stated on p. 257). We note that Maxwell did not finish the second edition, but died before that. He actually had no hand at all in the third edition as to any changes. The Second edition was later finished by Niven by simply adding the remaining material from the previous first edition approved by Maxwell. The printing of the first nine chapters of the third edition was already underway when J. J. Thomson was assigned to finish the editing of the manuscript.

Maxwell's work profoundly affected the course of science and the course of human history. Maxwell, Heaviside, Hertz, Gibbs, Lorentz and others participated in dramatically curtailing Maxwell's original 1865 quaternion theory to the much more limited subset that it is today. Since the early part of the 20th century, work has slowly been ongoing to move EM theory back to a higher group symmetry theory, which ironically it already was when Maxwell first created it.

**Maxwell's electrodynamics:** Simply put, Maxwell's theory of electrodynamics consists of Maxwell's equations. His fundamental theory consisted of some 20 quaternion equations in 20 unknowns, appearing in his 1865 paper. After Maxwell's death and some curtailment by Maxwell himself, Heaviside modified and sharply curtailed these equations, into the familiar four equations of today, as did Gibbs and Hertz. Lorentz further curtailed the Maxwell-Heaviside equations, by symmetrically regauging them. This simplified their mathematical solution, but it also inadvertently and arbitrarily discarded all open Maxwell systems far from **thermodynamic** equilibrium with their active environment (such as the modern active vacuum). See James Clerk Maxwell.

**Maxwell's Theory, fluid dynamics analogy:** *Considering and adapting the fluid analogy approach of James Clerk Maxwell:* The intensity of the vacuum virtual particle flux may be treated as the intensity of a potential, thus by analogy corresponding to pressure in a fluid. Polarity (charge) is a **process** for establishing a change in the intensity of the vacuum potential - and **thus** a change in the ambient pressure of the vacuum fluid. **Diffence** between vacuum pressures at two separated points creates a force **upon** any charge placed between those two points. Just as a differential in pressure between points in a fluid induces currents, a differential in vacuum pressure induces energy flow currents in the

vacuum fluid, which are called 'fields'. All EM circuits, charges, potentials, and forces in electrodynamics involve altering the vacuum to include altering its pressure and thereby producing the forces the resulting pressure gradients (fields) induce upon charges. All observable EM energy in space is EM energy intercepted and collected on charges, or assumed to be, and the spatial EM energy comes from the vacuum via these fundamental vacuum-engineering dynamics which all involve the giant negentropy 4-circulation between the time domain and 3-space.

**Michelson, Albert Abraham:** German-born American physicist, 1852-1931, who invented an interferometer (Michelson interferometer) named after him. Michelson used his interferometer in a renowned experiment in the 1880s designed to measure the velocity of the earth through the ether, which would produce a shift in his interferometer pattern. No such shift was observed, which indicated the absence of an ether wind and was largely responsible for the downfall of the concept of the material ether that had been previously assumed, including by Maxwell.

motionless electromagnetic generator (MEG): Transformer-like COP>1.0 electrical power generator invented by Patrick, Bearden, Kenny, Hayes, and Moore, ""Motionless Electromagnetic Generator," U.S. Patent # 6,362,718, Mar. 26, 2002. A second patent application is processing and several more are in preparation. In particle physics, any dipole (including a permanent magnet) is a known asymmetry in the fierce vacuum flux, continuously pouring out real EM energy extracted from the vacuum. The MEG continuously powers its transformer section core with a permanent magnet dipole, more than doubling the EM energy made available from **the** active vacuum via the permanent magnet dipole's broken symmetry in its exchange with the vacuum. [See M. W. Evans, P. K. Anastasovski, T. E. Bearden et al., "Explanation of the Motionless Electromagnetic Generator with O(3) Electrodynamics," *Found. Phys. Lett.*, 14(1), Feb. 2001, p. 87-94; "Explanation of the Motionless Electromagnetic Generator with the Sachs Theory of Electrodynamics," *Found. Phys. Lett.*, 14(4), Aug. 2001, p. 387-393]. The MEG nanocrystalline core material extracts the magnetic field B of the permanent magnet from the surrounding space and localizes it in the core material. The active vacuum asymmetry freely replenishes the withdrawn magnetic B-field energy in space surrounding the core, but with uncurled magnetic vector potential A rather than magnetic field B. This is an application of *geometric phase*, specifically the well known *Aharonov-Bohm effect*, with several thousand papers in the literature. The MEG then transduces and outputs magnetic B-field energy inside the **core** material and some of the field-free magnetic vector potential A energy in

space surrounding the core, effectively having available more than double the energy being made available from the permanent magnet, or normally available to a transformer. The output power of the MEG is a function of (i) the time rate of change of a small amount of input EM perturbation energy to the input coil, plus (ii) the intercepting and collecting secondary charges available in the secondary coil, (iii) additional energy from chaotic oscillations, (iv), sophisticated feedforward and feedback regenerative self-oscillations, and (v) the geometric phase (Aharonov-Bohm effect). It thus **is** a rigorous practical application of the geometric phase effect to a **macroscopic** power system, and in fact is the first such application in practical electrical power systems. The noted feature of the MEG is a purely electrical interaction in the output coils, in which the voltage and energy are in phase within  $2^\circ$ , differing from all other transformer-like systems. Thus the MEG directly delivers real power rather than apparent power. See Aharonov-Bohm effect.

**multicollection (of energy):** Multiple collection and re-collection in a circuit of the same energy flow from a source dipole, by rerouting either (1) the dissipated Poynting energy back around to the collectors for another pass by them, with additional collection, or (2) retroreflecting the nondiverged Heaviside EM energy flow component back and forth across the **surface** charges in the circuit conductors, iteratively diverging additional energy into the conductors to potentialize and power the Drude electrons, or (3) a combination of the two. The interesting point is that this effect **can** "use" the same energy to do repeated work, multiple times. It takes **advantage** of the fact that work is merely the change of form of energy, and that the new form can again be changed (as for example, back into the **first** form again) to do additional work, again and again so long as the **energy** in each transformation is held in the system without escaping. This process permissibly violates classical equilibrium thermodynamics and its **infamous** second law, since it is an open system freely receiving excess **energy** from its active environment and thus far from equilibrium with that active environment. As is well known, such systems are permitted to exhibit COP > 1.0 and even self-powering of the system and its load simultaneously.

**negative absorption of the medium:** Excess emission from an active medium, as in the Letokhov work and in Bohren's experiment. The excess energy is first absorbed from the vacuum interaction (actually from Heaviside's unaccounted energy flow component that usually does not interact with the system), and then it is re-emitted. This is actually a true "Maxwell's demon," as pointed out by Letokhov.

**negative resistor:** Any component or function or process in an EM system that freely receives energy from outside the system in unusable or disordered form within the system, transduces that energy into usable form, and outputs it so that it can do useful work. In a *true* negative resistor, that is the *net* function performed. We specifically do not include "differential" negative resistors such as the tunnel diode, thyristor, and magnetron, which dissipate and disorder more energy from the system itself, overall, than the fraction that they order and furnish back to the system in their negative resistance regime. In anti-circuits, true negative resistors are quite natural components. Every charge and dipole in the universe is already just such a negative resistor, freely extracting unusable EM energy from the seething vacuum, transducing it, and continuously pouring out real observable EM energy in all directions in 3-space. A negative resistor can produce the five magic functions: (i) self-ordering, (ii) self oscillation or self-rotation, (iii) output more energy than the operator inputs, (iv) power itself and its load freely, and (v) exhibit negentropy. The condition for self-powering of a system containing a true negative resistor was given by Gabriel Kron.

**negentropic:** Functioning to produce or involve negentropy; reordering previously scattered energy without requiring the operator to input energy to perform the reordering. A simple example is passive retroreflection of radially scattered EM energy. The conventionally unaccounted enormous and nondiverged Heaviside energy flow component surrounding every circuit and every field/charge interaction is an example of a dynamically reordered and organized energetic vacuum, and thus an example of a **giant** negentropy process. The continuous observable EM energy freely pouring at the speed of light from every dipole and charge in the universe is also **an** example of the giant negentropy process.

**negentropic engineering:** Expending a little bit of energy to form a dipolarity, and then intercepting, collecting, and using some of the enormous EM energy freely and continuously extracted by the dipolarity from the vacuum, indefinitely, without using any of the extracted EM energy to scatter the charges in the dipole and destroy it. Retaining the dipole intact avoids shutting off the furnishing of copious free energy **flow** from the vacuum to the attached external circuit. As an analogy, it allows an electrical windmill operating in (driven by) a free electrical wind from the external environment of the system.

**Newtonian recoil:** Newton's third law reaction from the affected entity back to and upon the effecting entity. The "action" is the action from **the** effecting entity upon the affected entity. The "reaction" is the action from

the affected entity back upon the effecting entity. Newton's third law actually implies that the cause interacts upon the effect and the effect reacts equally back upon the cause, thus producing a strange kind of equilibrium. In a time-reversal zone, the "recoil" is reversed in direction by parity reversal. Tentatively, one may interpret from pumped phase conjugation that the Newtonian third law reaction of one single acting force can be amplified by properly directing the actions of other acting forces. An interesting aspect is that a pumped phase conjugate mirror does not recoil, no matter how powerfully it is pumped or how powerfully amplified is the emitted phase conjugate replica wave.

Newton's third law: For every action there is an opposite and equal reaction. This law should be extended and restated something like this: "for every action there is an opposite and equal reaction if the causative mechanism of the reaction is allowed to occur without interference and is not first redirected away from its target." An example of a violation of Newton's third law as usually stated is provided by the emission of a phase conjugate replica (PCR) wave from a phase conjugate mirror material. No matter how powerfully pumped, the PCM does not recoil by the emission of the PCR wave. The reason is that the antiwave cause of Newtonian third law recoil was intercepted by nonlinear multiwave interaction (wave-to-wave **interaction**) before reaching its target nuclei and interacting with them, and was diverted away from the atom and on out of the phase conjugate mirror material. Since the causative mechanism for Newtonian recoil did not occur on the mass of the mirror, the mirror did not recoil. We also point out that, if Newton's third law is indeed engineerable and controllable, then  $COP > 1.0$  systems and self-powering EM systems are permissible a priori. In electrical system terms, this simply means that, if one can rid the system of its equal back emf or back mmf, the system can be **legitimately** self-powering because it no longer self-enforces the Lorenz-Lorentz symmetrical gauging condition.

**non-Abelian** electrodynamics: An electrodynamics based on a group theory in which the group operation is not commutative and hence not Abelian in nature. Contrast to an Abelian group in which the group operation is commutative.

nonequilibrium thermodynamics: Colloquial term referring to the newer **thermodynamics** of self-organizing systems and structures, far from equilibrium in their energetic exchange with their active environment, Since the **1960s**, there has emerged in physics (and in thermodynamics!) this surprising new area: the physics of far-from-equilibrium systems and the self-organization and large-scale ordering of such systems. The



equilibrium conventionally referred to is 3-space equilibrium, with no consideration of temporal equilibrium, although some pioneers of the field such as Prigogine are quite aware of the temporal disequilibrium also involved. Note that such "3-disequilibrium" thermodynamical systems are also in temporal energy flow disequilibrium as well as 3-disequilibrium, but overall are still in 4-equilibrium energetically. See **giant negentropy (of the dipole)**. For a necessary thermodynamics discussion, see Appendix A in this book.

**nonlinear material (optical):** A substance whose optical properties vary with the intensity of the light.

**nonlinear optical functioning:** Functioning in a manner prescribed by nonlinear optics and quantum optics, particularly with respect to time-reversal effects, use of phase conjugate mirrors, phase conjugate reflection, wave-to-wave interaction, and pumping for amplified phase conjugate reflection. To quote Knight, "A phase conjugate mixing device has remarkable optical properties: perfect retroreflection, the complete cancellation of optical aberrations and inhomogeneities in wavefronts, and the ability to reverse an optical beam and return it to its source." A most interesting modern science, eventually adaptable to COP>1.0 systems, is developing in the study of intensely scattering optical materials.

**nonlinear phase conjugate optics:** See **phase conjugate optics**.

**nonlocalization:** Producing or rendering an effect or effect-producing agent at a distance, rather than at the immediate location of the effector. Extended throughout a large region or system, or to a distant part of a large region or system, rather than being confined to a small region of the large region or system. Nonlocalization effects are absolutely prescribed in quantum mechanics, and are experimentally confirmed. They have been largely ignored in classical electrodynamics and electrical engineering. Nonlocalization can result from the existence and use of a multiply connected space, as in Bohm's quantum potential and hidden variable theory. Engineering of action at a distance by engineering the quantum potential through multiply connected space gives one method of energy amplification. This method has unfortunately been secretly weaponized in five nations of the world, and none of the technology is available for use in electrical power systems for energy amplification and solving the energy crisis.

**non-Riemannian geometry:** Riemannian geometry is the geometry of Riemannian manifolds — i.e., manifolds having an infinitesimal squared distance  $ds$  that is everywhere positive. A non-Riemannian geometry

violates this property. [A manifold is a topological space with certain prescribed characteristics.]

**nucleons:** A collective name for the neutrons or the protons in a nucleus. In the nucleus, the neutrons and protons are continually changing one into the other by exchange of the charge. What is called a neutron and what is called a proton is thus somewhat arbitrary, so long as one makes a rule and stands by it. The interesting thing is that, in a nucleus, there is already continuous and highly rapid transmutation activity between nucleons, all the time, without giant accelerations and operator input of very intense spatial energy. In short, nature shows in all matter that matter can be and is continually transmuted from instant to instant, and is "constant" only on the "**average**". Since most present models used for this are statistical rather than causative, it strongly suggests that we should look for a causal mechanism. The use of the time-reversal zone and time-energy has been nominated in this book as providing a causal mechanism for transduction, which can be directly engineered. It appears that cold fusion research already accomplishes transmutations using the suggested mechanisms. Several specific nuclear transmutation reactions applying the new mechanisms, and consistent with hundreds of cold fusion experiments, are given in the present book.

O(3) electrodynamics: An electrodynamics extended from a two-dimensional inner group symmetry to a 3-dimensional inner group symmetry. O(3) electrodynamics also becomes an important subset of Sachs' **unified** field theory. The inner group symmetry of O(3) can be taken as normal space, which immediately opens up engineering the vacuum and using **spacetime** curvature engines to directly engineer matter for us.

open system: A system that communicates with its environment, and exchanges energy, matter, or both between system and environment. With the possible exception of a few theoretical or hypothetical systems, all systems in the universe are in fact open systems. An open system may be in equilibrium with its active environment, so that it cannot accept, store, and utilize any excess energy from the environment. Another open system may be in disequilibrium with its active environment, in which case it can accept, store, and utilize excess energy from the environment. When the operator inputs EM energy into an open equilibrium system, he automatically breaks its equilibrium condition with the external active environment, decreasing the system's entropy. This is an excited state, and the system will subsequently decay back to equilibrium (maximum entropy) condition by emitting or dissipating its excess energy. The reader interested in the thermodynamics should read Appendix A in this book,

since the thermodynamics definition (or misdefinitions!) of "closed system" actually permits the system to be open with respect to energy exchange with its active environment — either in equilibrium or disequilibrium — and only prohibits exchange of mass across the system boundaries. By that definition, a "closed system" can be far from energy flow equilibrium with its external environment, and hence permitted to perform  $COP > 1.0$  or even  $COP = \infty$ . Hopefully our discussion in Appendix A will clarify the position we have taken on this matter.

**optical switching:** Switching of optical signals, or switching using optical frequency switching techniques, components, and circuits.

**orthodox transistors:** Ordinary transistors in use today, i.e., as contrasted with the Fogal semiconductor and its special functions.

**orthogonal rotation:** Simply speaking, a rotation from one direction to a direction at right angles to it. The Lorentz transform of special relativity, e.g., is a formula for the rotation of an object and all its parts away from its line of motion, as a function of the object's velocity, in a direction toward the time axis. The speed  $c$  just represents a full orthogonal turn, so that the projection intersection of the object with the observer 3-space, along the original line of motion, is zero.

**outfolding:** Translation by a system of received input longitudinal EM waves entering inside its potentials and fields, into conventional EM waves present in the system and then output from it. The opposite of *infolding*.

**overpotential:** Essentially the overpotential (as in an electrode in a solution) is a shift in the Fermi level necessary to allow the electron in the electrode metal to have energies overlapping with vacant acceptor levels in molecules adjacent to the electrode in the solution. The overpotential effect appears at small "double surfaces" of things in very close contact, particularly in electrochemistry and in solid state physics. The overpotential enables electron transfer, e.g., by tunneling. The overpotential increases with the log of the reaction rate that occurs at the overpotential location. For a small reaction rate, the overpotential is small; but for a small increase in the overpotential there occurs a dramatic increase of reaction rate. Fogal has utilized the overpotential effect in his semiconductor, to great advantage in accomplishing unusual charge blocking and other special effects. See **tunneling**.

**overunity coefficient of performance (COP > 1.0):** More energy out or work out of a system than the operator or experimenter must furnish **and**

**input.** The excess energy is input from the active environment. See **coefficient of performance.**

**parity:** Deals with studying a system of a sequence of events as if the events were reflected in a mirror. A system has parity if it undergoes no fundamental operational change if replaced with its mirror-reflected twin.

**partially time-reversed region:** A region of spacetime in which an object **temporarily** experiences not only the ordinary forward flow of time, but also an extra induced backwards flow of time, usually a fraction of the time- forward time stream. It appears that the combination of the two is what **constitutes** time dilation in relativity. In a mixed time-forward (photon interactions) and time-reversed (antiphoton reactions) zone, if time-forward predominates, the law of attraction and repulsion of charges is **partially** reversed, leading to overall reduction of the forces — which remain **in** their usual directions. If the time reversal predominates, the law of attraction and repulsion is reversed, and in that region like charges attract and unlike charges repel. If time reversal and optical pumping are **combined**, the reversed law forces of attraction of like charges and **repulsion** of unlike charges are amplified also.

**particle physics:** The branch of physics using accelerators to study high-energy particle collisions, to determine properties of atomic nuclei and of the **elementary** particles themselves. It appears that conventional particle physicists do not recognize or consider time-energy interaction and time-reversal zone nuclear interactions at all. Hence the present "high (spatial) energy" physics is a far lower "total" energy physics than is the physics where time-energy is deliberately utilized. When time-energy is utilized, then the **total** energy of the photon varies inversely as a function of its frequency rather than directly as a function of its frequency. Lower frequency photons have very much greater total energy than higher frequency photons. For practical electrogravitation, therefore, one is interested in lower frequency bandwidths such as the ELF region.

**Patterson effect:** The intense multiple scattering, multiple pass, multiple collection of energy **density** flow in an assemblage of palladium-clad spherical bead capacitors, as the palladium adsorbs hydrogen ions from the fluid in which the beads are immersed, and thereby charges up as a capacitor, becoming an energy-flow generator, and nonlinearly increasing the energy-flow as the charge of the capacitors increases.

**Patterson Power Cell®:** Patented overunity power **unit** by James Patterson, which has been independently validated to yield COP > 1.0.

However, continuing difficulty has been experienced with the palladium

metal used in the effect. See James Patterson, "System for Electrolysis of Liquid Electrolyte," U.S. Patent No. 5,372,688, issued Dec. 13, 1994. Patterson has several other patents in the area.

**perpetual motion machine:** The rather archaic and dogmatic assertion that no machine can indefinitely operate, since no closed system can input its output power back to itself while powering a load, because powering itself and its load violates the *equilibrium* thermodynamics (i.e., the thermodynamics of a closed system). Every system is already an open system in a violent energetic exchange with the active vacuum, so the pronouncement is a non sequitur assuming a false straw man — that every machine is a truly closed system or is in energy flow equilibrium with its active environment and can be treated as if it were a closed system. (The thermodynamic definition of "closed system" is misleading; it refers to a system where no mass exchange crosses the system boundary, but energy flow exchange can and does freely cross it. See Appendix A to this book for a proper discussion). Further, the equilibrium thermodynamics cited does not necessarily apply to either an open thermodynamic system far from energy equilibrium, or to a closed thermodynamic system in energy flow disequilibrium, as is now well known. After all, a common windmill will operate so long as there is a wind or until something breaks. But since it involves a mass flow across the system boundary, it is said to be a true open thermodynamic system. In electrostatics, a closed system (with no matter exchange across its boundary) can yet have copious energy flow exchange across its boundary, and thus be far from EM energetic equilibrium with its external active environment. The charges and the dipoles in matter operate in a free "time-energy flow wind" and virtual particle flux wind in the vacuum, which are constant and unfailing, and thus charges and dipoles have been freely and continuously outputting real EM energy flow into 3-space for some 14 billion years. All assertions that overunity EM systems are perpetual motion nonsense are completely refuted by every charge and dipole in the universe. To repeat such gibberish only reveals the ignorance of the person making the improper assertion.

Ironically, those dogmatists fond of hurling perpetual motion labels at overunity researchers already recognize the overunity legitimacy of open systems far from thermodynamic equilibrium with their active environment; they refer to such systems *as false perpetual motion machines* or *oxfictitious perpetual motion machines*. All of them also accept the classical electrostatics assertion of the source charge, from which all EM fields and potentials and their energy come. So the very dogmatists

so confidently pontificating that perpetual motion machines are ludicrous, themselves already implicitly accept that every charge and dipole in the universe is precisely such a perpetual motion machine, freely and continuously creating energy right out of nothing. No legitimate free energy researcher in his wildest nightmares has proposed such perpetual motion machines on such a universal scale. The greatest perpetual motion nuts on earth are precisely those pundits so confidently castigating the notion that an electrical system can output more energy than the operator himself must input. We will have a modicum of tolerance and respect from them, when they can demonstrate how they can purge all those "perpetual motion charges and dipoles" — and all their EM fields and potentials — from **their** own accepted electromagnetic model. Obviously if they do that, they simply destroy all EM energy in space, in systems, and in the entire universe. This is the absurdity of the position these pundits advocate so ignorantly.

**phase conjugate:** Of an entity: its time reversal. For waves: often referred to as *wavefront reversal*.

**phase conjugate mirror:** A nonlinear material which, when provided with an input wave, emits a phase conjugate replica (time reversed replica) of **that input** wave. The input wave is by practice called the *signal wave*. The time-reversed wave output is by practice called *the phase conjugate replica*.

phase **conjugate optics:** That portion of nonlinear optics dealing with multiwave mixing, formation of time-reversed waves, phase conjugate reflection (PCR), phase conjugate mirrors (PCMs), pumping PCMs to amplify **their** emitted PCRs, nonlinear interferometry, distortion correction, self-targeting, laser tracking, adaptive optics, and soon.

**phase conjugate replica (PCR):** Of a wave: the time-reversed duplicate of a signal (input) wave, after its detection by interaction with charge. We point out *there may still be some foundations difficulty, however, with the form in which the phase conjugate replica wave exists in spacetime prior to its interaction with charge and prior to its observation (observing the effect of its interaction with charged matter)*. Indeed, there is very serious foundations difficulty with the very notion of an EM transverse wavefront in space, traveling at the speed of light, for no such thing exists. See Robert H. **Romer**, "Heat is not a noun," *Am. J. Phys.*, 69(2), Feb. 2001, p. 107-109. This is an editorial discussion by the Editor of AJP of the concept of heat in **thermodynamics**, where heat is not a substance, not a thermodynamic function of state, and should not be used as a noun. In

endnote 24, p. 109, he also takes to task "...that dreadful diagram purporting to show the electric and magnetic fields of a plane wave, as a function of position (and/or time?) that besmirch the pages of almost every introductory book. ...it is a horrible diagram. 'Misleading' would be too kind a word; 'wrong' is more accurate. " "...perhaps then, for historical interest, [we should] find out how that diagram came to contaminate our literature in the first place."

**phase conjugating action:** In nonlinear optics, the process or action of producing a time reversed replica of an input wave. For a particle, producing its antiparticle. For a living cell, dedifferentiating it back to some previous form, genetics and all. In the presence of a predominately time-reversal zone, however, the cell is in a predominately phase conjugating mode *a priori*. Phase conjugating it a second time converts it from dedifferentiating to redifferentiating mode. We hypothesize that these combinations are the actual mechanisms generating cellular dedifferentiation and redifferentiation in the cell, tissues, and body. A future book will address that issue; meanwhile, see the 119-page "porthole briefing" on the author's website, [www.cheniere.org](http://www.cheniere.org).

**phase conjugation:** In nonlinear optics, the novel nonlinear mixing of waves which generate an output wave — called the phase conjugate replica or time-reversed replica — that precisely retraces the path previously taken by the input wave that stimulated the action.

**phonon:** A quantum of the lattice vibration energy in a crystal. This mechanical vibration energy is considered a field, and the phonon is the quantum of that mechanical energy field. Lattice vibrations in a crystal thus are characterized by waves in the lattice, where the waves are comprised of ordered phonons. Interesting effects occur between electron currents and phonons, due to electron-phonon interaction.

**photon:** In physics, the basic action quantum. Conventionally considered to be the basic quantum of the EM field. There is a foundations problem with the latter concept, because of the dichotomous use of "field" for both the *effect* force field in 3-space after observation (detection) and the *causal* force-free field in 4-space prior to observation (detection). Strictly speaking, the photon is the quantum of the causal 4-space massless **field**, since the photon possesses both spatial EM energy and time increments. In curved spacetime, the photon may possess mass because the time flow is a mix of time-forward and time reversal, and thus cause and effect are slightly intermixed as well. We point out that, in a negatively curved spacetime, the photon mass is negative, the photon energy is negative, **and**

the photon fields are negative energy fields. Presently the negative energy photons do not appear to be utilized in physics except haphazardly if at all.

This may represent a large class of photon interactions with matter that have been inadvertently omitted.

**ping-pong:** Colloquial term for iterative retroreflection.

pinned electrons: Electrons held stationary by a magnetic field, or other set of forces that react to "push them back into their positions and hold them fast" whenever they try to spatially move away.

pinning: The act of restricting (by restoring forces and fields) spatial movement (particularly of electrons) due to a disturbing magnetic field or other external force.

polaron: An electron in a substance, where the electron is trapped in a potential well due to polarization charges on surrounding molecules. The excitation in a substance is analogous to an exciton in a semiconductor.

**positron:** An antielectron (time-reversed electron), possessing a positive charge and positive mass. *Mathematically an empty negative energy electron* state in the Dirac sea whose usual occupying electron has been removed, leaving a four dimensional "Dirac sea hole," may also be regarded as a positron for many purposes, at least *after observation resulting from interaction with matter*, so long as the remarkable difference of the Dirac 4-hole prior to observation from the Dirac 3-hole **after** observation is understood. Mathematically, the lattice hole previously occupied by an electron can be considered a positron-equivalent (i.e., as if observed), again so long as the real differences are kept in mind, between a Dirac hole *before* observation and what results after its observation by interaction with mass. This is important, because otherwise one is again substituting the effect for the cause. In addition, if the two are confused, **then** one also arbitrarily discards the negative energy fields and negative energy potentials of the source 4-hole in the vacuum prior to observation. That effectively discards anti-circuits and the ability to engineer practical electro antigravity.

power: In physics, the time rate at which work is done (at which *the form of energy is changed*). In electrical engineering, the term "power" is erroneously but ubiquitously also used to loosely mean "energy." Hence such odd and improper expressions as "draw power from the source," which is a non sequitur. Nonetheless, such non sequiturs are so universally utilized in electrical engineering that they have become a part of the literature itself.



**Prigogine, Ilya:** Noted Belgian chemist and Nobelist, and one of the pioneers of the thermodynamics of open systems far from thermodynamic equilibrium. Prigogine was awarded the 1977 Nobel Prize for his work on the theory of dissipative structures in nonequilibrium thermodynamics.

**Poynting, John Henry:** An English physicist who lived from 1852-1914, whose contributions to electromagnetics included the energy flow theory now known as Poynting flow. He contributed the Poynting theorem, which states that the rate of EM energy loss in a specific region of space is equal to the sum of the dissipation rate (heat loss) flowing across the boundary of the region. Concurrently with Oliver Heaviside, Poynting conceived the notion that energy flowed through space, which previously had not appeared in physics. Heaviside actually published first, but obscurely; Poynting published in a prestigious journal, so the theory came to be known as "Poynting theory."

**Poynting energy:** A loose term (not rigorous!) used to loosely describe the flow through space of Poynting energy density  $S = E \times H$ , which is that component of the total energy flow in space that will be *intercepted and collected* by the intercepting charges, circuit, etc. It actually describes not the energy flow density *per se*, but the component of it that would be intercepted by a unit point charge, or that actually enters an intercepting circuit. Poynting started with the assumption of the component of the energy flow that enters the circuit, *a priori*. Only the work of Heaviside considered the remaining component of the energy flow that is not intercepted by the charge or by the circuit. Because of the startlingly great magnitude of this remaining nondiverged Heaviside component, Lorentz integrated the entire (Heaviside) energy flow vector around a closed surface surrounding any volume element of interest. This discarded the entire nondiverged Heaviside component, and removed any necessity of considering or explaining how every generator and battery already pours from its terminals up to  $10^{13}$  times as much EM energy as the presently accounted energy input to the shaft of the generator or the chemical energy available in the battery. We believe that the discarded and unaccounted Heaviside nondiverged energy flow component accompanying every field-particle interaction is responsible for the puzzling excess gravity holding the arms of the spiral galaxies together. In short, we believe it is the solution to the "dark matter" problem, now often believed to be a "dark energy" problem.

**Poynting energy density flow:** A somewhat more rigorous term used to describe the flow through space of the Poynting energy density flow

$\mathbf{S} = f(\mathbf{E} \times \mathbf{H})$  component that would be intercepted by a unit point charge or an intercepting circuit.

*Poynting* energy flow: A loose term (not completely rigorous) used to describe the flow of energy density  $f(\mathbf{E} \times \mathbf{H})$ . Rigorously, both  $\mathbf{E}$  and  $\mathbf{H}$  are "defined" only after their reaction with a unit point static charge. Hence  $\mathbf{S}$  is the resulting component of the overall energy flow that interacts with the charges (with the circuit) and is diverged into the circuit to power it. It is not the entire energy flow, which also includes a vast Heaviside nondiverged component that does not strike the charge and interact with it, and hence does not interact with the circuit but is just wasted. See Heaviside energy flow component and Poynting energy.

Poynting generator: Colloquial term for any dipole or potential difference that represents a broken symmetry in the vacuum's virtual particle flux, and hence extracts virtual energy from that asymmetry, and gates it out as a gushing energy flow in 3-space. When both electric field and magnetic field are involved, the component of the energy flow that would be intercepted and diverged by a unit point charge is the Poynting energy flow  $\mathbf{S} = f(\mathbf{E} \times \mathbf{H})$ .

**Poynting** vector: The vector  $\mathbf{S}$ , given as  $\mathbf{E} \times \mathbf{H}$ , used to represent the Poynting (intercepted and collected by a unit point coulomb) energy density flow component. In Heaviside's version  $\mathbf{E} \times \mathbf{H} + \mathbf{G}$ , where  $\mathbf{G}$  is an energy circulation flow term of trapped EM energy flow. Heaviside later **realized** that such a closed energy circulation flow exhibits substantial **gravitational** effects; in modern terms we would say that it represents an **appreciable** local curvature of spacetime. Unpublished notes on the gravitational aspects were found beneath a floorboard in his little garret apartment, years after his death. We also point out one limitation of the present use of the Poynting vector: It has rather universally been **associated** only with the flow of *positive* EM energy, and not with the flow of *negative* energy. Indeed, the concept of negative EM energy is still **confused**, with different views and positions, and still in debate without complete scientific consensus.

PPCM: Pumped phase conjugate mirror. A phase conjugate mirror material that has introduced to it apposite or "pump" waves (in other words, **stress** waves). In effect, pumping is "stressing" or "squeezing" rhythmically. It is also varying a stress potential, which emits longitudinal EM waves, each accompanied by a correlated scalar (time-polarized) wave. In the phase conjugating process, up to all the energy in the pump waves can be output as the energy in the emitted phase conjugate replica

wave. Thus the PPCM may be viewed as an *amplifier*, very similar to a triode. When the time-components of the photons in the signal wave input and also in the pumping waves are considered, then there is a functioning of the pumping also ongoing in the time-domain. There is a rhythmic variation of stress in the time-domain also, which creates the correlated time-polarized EM wave accompanying the longitudinal wave from the 3-space pumping.

So the time-reversal aspect (formation of the phase conjugate replica wave) may be thought of as a rhythmic time-stress wave (pumping or stressing in the time domain) which, by alternately decreasing and increasing the time potential of the mirror, produces two temporal force effects. During the decreases in temporal potential of the mirror, the time-force from the input wave and from the pump waves is forward into the mirror material, allowing the input and interaction of these waves. During the increase in temporal potential of the mirror, a reversed temporal force from the mirror back to the past (temporal potential earlier in 4-space) of the input "signal" wave. The pumping energy (excess temporal potential energy) adds the gain to the phase conjugate replica wave,

**probability:** The probability of a simple event is the ratio of the number of times it occurs to the total number of trials (for a large, essentially infinite number of trials). Note that "trials" constitute things that have occurred (are past, have been observed). Probability has resisted rigorous logical definition by Aristotelian logic; the reason is that it is an expression of the fourth law, the identity of opposites. Probability is an expression of the future (that which has not occurred) in terms of the past (that which has occurred). Consider *throwing a die to land with one face up*. Thinking of the event (as if it has just occurred, in terms of the most recent past), one can conceive six ways of looking at it. In other words, one can conceive of six "most recent pasts", however, these have not occurred. We were merely thinking of them as if they had occurred. By the fourth law, the *total* "most recent pasts that have not occurred" is identical to the "most immediate future" that has not occurred, on the common boundary between past and future. If one therefore *collects* all six "most recent **pasts** not occurred" they turn into the most immediate future, by the fourth law of logic. One may argue that only a single one of the events will actually occur. Here one counters with the observation that, when it occurs, it is the past, not the future, and then it has not been collected so as to move **to the** boundary. In theory, the hidden variable approach makes it possible to directly engineer those probabilities while the Schrodinger wavefunction is still propagating and has not yet collapsed to constitute an "observation."

I.e., it is theoretically possible to engineer Wheeler's "pre-reality," and **determine** in advance just which of the outcomes will occur.

**Puthoff, Harold:** Noted physicist active in a variety of fields and investigations including in psychoenergetics, extended electrodynamics, **energy** from the vacuum, inertia, anti-gravity, parapsychology, remote viewing, psychokinesis, zero-point energy of the vacuum, and cosmology. We are particularly impressed with Puthoff's cosmological feedback **principle**. Together with Cole, Puthoff also proved that thermodynamics does not prohibit extracting usable EM energy from the active vacuum. See Daniel C. Cole and Harold E. Puthoff, "Extracting Energy and Heat **from the Vacuum**," *Phys. Rev. E*, 48(2), Aug. 1993, p. 1562-1565.

**QM vacuum:** The quantum mechanical vacuum, which models the vacuum as an intense flux of virtual particles, each appearing and **disappearing** in such extremely short time intervals as to be unobservable **individually**—although as physics develops, from time-to-time what is observable changes because of increased observation techniques. Violent fluctuations of extremely short duration constantly occur in the QM vacuum **flux**. Various calculations estimate the energy density (in mass units) as up to  $10^{80}$ - $10^{90}$  grams per cubic centimeter (in mass density units), or even greater. The vacuum is sometimes described as two separate components: (1) the ambient or average vacuum in deep space, which can be taken as a scalar potential having an enormous energy density, and (2) the **fluctuations** superposed upon the ambient vacuum as local violent potential energy changes. Finally, we note that any EM potential in a system is *a priori* a change to the local vacuum scalar potential.

**quantized:** Adjective which means (i) reduction of some observable quantity to multiples of some small, indivisible unit, or, (ii) expressed in terms of quantum theory.

quantum: A single "particle" of the quantity *action* (angular momentum). Often confused as a single quantity of energy alone.

**quantum electrodynamics:** The theory of photons and electrically charged **particles** and their interactions. The use of the term "quantum" implies that the EM radiation's discrete photon nature is significant, so that quantum theory must be employed.

quantum **field theory:** A quantum mechanical theory in which "... a physical field is considered as a collection of particles and forces, and observable properties of an interacting system are expressed as finite quantities rather than state vectors." [*Dictionary of Science and*

*Technology.]* More simply (after Davies, *The New Physics*, 1989): "The theory that describes the quantum effects of a classical system of fields defined on space-time and satisfying various partial differential equations." Particles are taken as quanta of fields similar to photons being quanta of the electromagnetic field. Each type of particle is represented by an operator that obeys certain commutation laws. The theory relates gluon fields and intermediate vector boson fields to the strong and weak interactions, and allows an overall theory of fundamental particles and their interactions.

quantum potential: A special potential added to the Schrodinger equation by Bohm in his hidden variable theory of quantum mechanics. The quantum potential is a multiply connected entity, so that it "occupies" widely separated but multiply connected points, events, or objects. It is also an extraordinary energy amplifier, since any energy input to one of the multiply connected points simultaneously and instantly appears in every other connected point, regardless of distance or location in the universe. In real life, the quantum potential also has a "coefficient of multiple connectivity", so that only a fraction of the energy input to one multiply connected point will appear in the other points of the multiple connection group. The quantum potential has been strongly weaponized by five nations, and quantum potential weapons are the dominant weapons on earth, being more powerful than nuclear weapons. In theory the quantum potential together with engines and antiengines could be used to treat and cure a given disease in all persons on earth simultaneously, or in one nation or area simultaneously. Sadly, engines have been developed to generate diseases in a targeted populace, rather than engines to heal the populace. Russia and Brazil have had the quantum potential weapon for some time, as have two nations friendly to the United States. In 2001, China also deployed the quantum potential weapon.

quark: Fundamental particle theorized to comprise hadrons (particles such as protons, neutrons, and mesons) by combining in twos or threes. There are six varieties of quarks. The difference between a proton and a neutron, e.g., is merely the orientation of a single quark. In a time reversal zone (TRZ) in the electrolyte in cold fusion experiments, the gluon forces can be significantly reduced, so that the quarks are nearly freed. Two protons (H<sup>+</sup> ions) can attract together in a TRZ so closely that each enters the reduced strong force region of the other, forming a quasi-nucleus. As the ions in solution outside the TRZ move to cancel the TRZ, it decays and the quasi-nucleus becomes an increasingly excited state, seeking to decay. Preferred method of decay is by quark flipping. So one quark flips, so that

the quasi-nucleus has become a quasi D+ nucleus. As the TRZ vanishes and time-forward resumes, the strong force recovers faster than the Coulomb barrier returns. Consequently, the quasi-nucleus of D+ merely tightens into a real nucleus of D+. This is one of the standard transmutation reactions in cold fusion experiments, forming excess deuterium.

**quaternion:** Expression comprised of the sum of four terms, one of which is real and three of which contain imaginary units, and where the terms can be written as the sum of a scalar and a three-dimensional vector.

**quaternion algebra:** The algebra of quaternions and their mathematical operations. Quaternion algebra is of higher topology than either vector or tensor algebra. Maxwell's original 1865 equations are some 20 equations in 20 unknowns, in quaternion and quaternion-like algebra. Heaviside and others reduced the algebra to vector algebra and some four equations; at his death, Maxwell himself was rewriting the equations in his *Treatise* to purge the quaternions, because of the controversy over the difficult

quaternion form. The present vector equations taught in university as "Maxwell's equations" are in fact Heaviside's truncation of the Maxwell theory. Going to tensor algebra electrodynamics does not recover the full range of Maxwell's original 1865 quaternion EM theory.

**quintessence:** Literally, the "fifth essence". In short, *dark energy*. We have nominated the arbitrarily discarded, vast Heaviside nondiverged energy flow component surrounding every interaction of charge with field as the dark energy that is the source for the excess positive gravity holding the arms of the spiral galaxies in place. See dark energy, positive.

**reactive power:** Electrical power, measured in volts-amps-reactive (vars) that cannot do work as is. For sinusoidal waveforms, the formula for reactive power is  $P_r = I V \sin \theta$ , where  $\theta$  is the phase angle between the voltage and the current.

**real hidden dynamics:** The dynamics of vacuum engines, or of "internal energy" or "internal work" ongoing in a system or volume of space. These internally organized forces, fields, and energies involve dynamic curvatures of spacetime, and it is this dynamics of spacetime itself that provides the continuous work and dynamics of internal energy. See Einstein's second postulate extended; infolded; dimensioning.

**real hidden vectors:** The "hidden" or "infolded" real vector components, e.g., of a zero vector summation system. The individual hidden vector cannot spatially translate the entire bulk system, but it can interact inside

the system to perform *internal work* upon it or upon some particular portion of it. Such a system of a finite number of infolded deterministic vectors is said to constitute a "dimensioned" stress potential. Specifically dimensioned potentials, fields and waves thus can be constructed, so that they carry specific vacuum engines (spacetime curvature engines). The interactions of these dimensioned EM entities may differ from normal EM interactions in chemistry, physics, biological systems in general, cells in particular, etc. The long neglected combination of Whittaker's 1903 decomposition of the scalar potential, together with his 1904 demonstration that any EM field or wave pattern decomposes into two scalar potential functions, has neglected the development and use of the "internal EM" theory and technology for a century. One or more nations has, however, highly weaponized "dimensioned EM fields, waves, and potentials" as evidenced by the peculiar and anomalous results of the decades-long microwave radiation of the U.S. Embassy in Moscow. See dimensioning.

real power (active power): Power, measured in watts, that can do work, including generating heat. For sinusoidal waves, real power is given by the formula  $I \cdot V \cdot \cos \theta$ , where  $\theta$  is the phase angle between the voltage and the current. Note that when higher group symmetry EM effects are involved (such as the Aharonov-Bohm effect), then the "normal" behavior of circuit components can be altered dramatically. As an example, in the MEG the secondary (output) coils of the transformer section are caused to exhibit a purely electrical interaction with the electrons and electron currents in the coils themselves. Consequently *the output current and voltage are in phase, in complete violation of conventional transformer theory and conventional assumptions about the interaction of inductors*. So the output of the MEG is real power, and phase angle does not enter into it.

regauging: In electrodynamics, changing the scalar potential or the vector potential, or both. If one or both of the potentials is/are changed so that a net new force is created in the system, that is an *asymmetrical* regauging. If only one potential is changed, a net force results and that is an asymmetrical regauging. If both potentials are changed but carefully selected so that the free force resulting from one change is equal and opposite to the free force resulting from the other, that is a net *symmetrical* regauging, often called "Lorentz regauging" or the "Lorentz condition". We note that longitudinal EM waves are produced very simply by rhythmically oscillating the magnitude of a stress potential, which is naught but coherently oscillating the individual vectors of a set of EM fields that sum to a zero vector resultant. The locked-in stress in T. Henry

Moray's semiconductors used in his radiant energy device tubes and the locked-in stress in the Chung negative resistor thus have to do with the production and use of longitudinal EM waves, time-polarized EM waves, and stress potentials.

reflection: The rebound of light or other energy from a surface.

refraction: The bending of light as it passes from one medium to another or through a density change in a given medium.

retarded wave: An electromagnetic wave that is derived from retarded fields, which in turn are derived from retarded potentials. The retarded wave at a point or region of space has arrived there or exists there as the result of the dynamics of charges and currents that existed at earlier times elsewhere. Compare to advanced electromagnetic wave.

retroreflecting: Precisely reversing the path of a reflected wave or object.

Sachs, Mendel: Noted scientist who has completed the work of Einstein and developed a unified field theory covering the universe from the tiniest part to the entire conglomerate. Since  $O(3)$  electrodynamics has been shown by Evans to be an important subset of Sachs' theory, then for the first time we have a higher group symmetry electrodynamics and a unified field theory that is largely engineerable by novel electrodynamic means, using the  $O(3)$  model.

Sachs' unified field theory: An extension and completion of Einstein's work that includes the universe and its dynamics from the tiniest part to the entire conglomerate, and includes quantum mechanics, electromagnetics, gravitation, and the strong and weak forces. See particularly Mendel Sachs, *General Relativity and Matter*, Reidel, 1982; *Quantum Mechanics from General Relativity*, Reidel, 1986. Sachs' unified theory provides a great generalization of general relativity, quantum mechanics, and electrodynamics reaching from the quarks and gluons to the entire universe. Much of the model is also engineerable by higher group symmetry electrodynamics such as the  $O(3)$  electrodynamics pioneered by Evans and Vigier.

scalar: Characterized by magnitude only. However, with respect to polarization, a scalar photon is a term in use for a *time-polarized* photon, where the EM energy oscillates along the time-axis. Hence a scalar wave, following the same terminology, is an EM wave composed of scalar photons, hence whose EM energy is oscillating along the time-axis. The term "scalar" is used in the sense that no vector in 3-space exists even though a vector (and a variation of its magnitude) exists along the time



axis. The effects are observed as an oscillation in the rate of flow of time, hence a "time-density" oscillation. The term "scalar" with respect to polarization implies only that there is no vector component in 3-space.

**scalar entity:** In ordinary vector analysis, an entity thought to be completely characterized by magnitude alone. Actually this is incomplete; a scalar entity must contain a time-like vector component, if it is to steadily persist in time. What we usually do unthinkingly is assume a continual series of successive observations or  $d/dt$  operations upon the  $kt$  nature of a scalar  $k$ . We conceive these individually frozen 3-space snapshots to "continuously exist" since we can readily recall the "stream" of  $d/dt$  differentiations in our mind and memory. Since all observation is 3-spatial, then no observable *persists continuously* in time; instead, it *continually recurs* in time, instant to instant. This "iterative successive stream of frozen 3-space snapshots" exists in the continual and rapid recall from our memories. Compare this to the similarity of observing a sufficiently rapid series of still pictures on a screen, where the individual pictures differ by a time sequence taken of some phenomenon. One "sees" the recreation in one's mind of the flow through time of those events and entities so photographed. Yet at any one instant, there is only a single frozen snapshot on the screen, and no motion at all was "physically" observed.

**scalar electromagnetics:** Colloquial term for the electrodynamics that arises from considering transverse EM waves, longitudinal EM waves, time-polarized EM waves, electrogravitation, superluminal EM signals, interferometry, nonlinear optical functions, time-as-energy, and the infolded electrodynamics inside all usual EM fields, waves, and potentials. In secret superweapon projects, the Russian term for scalar electrodynamics is *energetics*. It is divided into three major fields, depending upon the intended target. Targeted against inert matter, **systems**, and fields, the same term is used: *energetics*. Targeted against the **physical** and chemical processes and biological fields and potentials of living organisms, the term used is *bioenergetics*. Targeted against the mind's time-polarized EM functioning and dynamics, the term *psychoenergetics* is used. In the latter, higher group symmetry electrodynamics and extensions to quantum field theory play significant roles. Significant progress and strategic testing of all three branches of energetics has been evidenced worldwide. Progress in the energetics branch was confirmed by a statement by U.S. Secretary of Defense Cohen in 1997. Quoting: "**Others** are engaging even in an eco-type of terrorism whereby they can alter **the** climate, set off earthquakes, volcanoes remotely through the use of

*electromagnetic waves...So there are plenty of ingenious minds out there that are at work finding ways in which they can wreak terror upon other nations...It's real, and that's the reason why we have to intensify our efforts* " Secretary of Defense William Cohen at an April 1997 counterterrorism conference sponsored by former Senator Sam Nunn.

Quoted from DoD News Briefing, Secretary of Defense William S. Cohen, Q&A at the Conference on Terrorism, Weapons of Mass Destruction, and U.S. Strategy, University of Georgia, Athens, Apr. 28, 1997.

scalar potential: Usually considered synonymous with the electric potential. The concept of potential was developed by Poisson, Green, and others **from** about 1813 to 1827. Three notions involved in the **development** of the concept of the potential are: (i) there is the collection of storage of energy in the system, via the collection or storage of some entity therein, and this "potential energy" can be released and dynamically used, (ii) the potential is a scalar function whose spatial rate of change is a vector force, and (iii) the dynamics of the stored energy is suspended by the "storage" or "collecting" entity; in other words it is a sort of "suspended action" waiting to be unleashed. *It requires some action—such as interception and divergence—to release the leashed energy.*

The second notion is false, since no force exists in the absence of mass because mass  $m$  is a *component* of force  $F$  via  $F \equiv dp/dt = (m)dv/dt + v dm/dt$ . It is corrected by stating that its spatial rate of change *when interacted with charged matter* is a vector force. For the third notion, we note that the concept of a "virtual" particle or particle flux means that it cannot become **me** observable unless some interaction is imposed. So we may handle the "third notion" requirement by assuming the potential in modern terms to be composed of hidden virtual particle flux, or hidden wave flux, in wave-to-wave interaction. Physics tries to define the electrical potential as energy per coulomb,  $W/Q$ . That equation, however, is actually not a definition at all (no equation is a definition), but rather is an algorithm for calculating the magnitude of the excess energy collection/collecting upon a coulomb of charge, when that coulomb is immersed in the potential. It in fact is the *reaction cross section* of the potential, not the potential entity itself. This now begins to give us a clue, Potential is *energy* in some fashion, and the term "potential energy" is a redundancy. So the entity must have essentially the same definition as energy! **Potential** energy, collected energy, stored energy, whatever—it is energy first and foremost. How it is collected and what it is collected upon or in, determines **the** "type" of potential. It also cannot be logically defined as the work expended by it upon a unit charge. The causal entity itself is

not the action taken; just as a man is not definable as "how far he has run" in some race.

**scattering processes:** Collision processes in which an incident particle such as a photon, electron, or proton, of known energy or direction or both, collides with another entity, and emerges from the collision with a different energy or direction or both.

**Schrodinger, Erwin:** Noted Austrian physicist, 1887-1961, and Nobelist who discovered the wave equation named after him as the Schrodinger equation, and performed other vital work in wave mechanics.

**Schrodinger equation:** In quantum mechanics, an equation that describes the propagation of waves associated with subatomic particles, or more generally, that describes the evolution over time of the quantum state of a system. The fundamental quantum mechanical equation governing the behavior of wave functions.

**self-energy:** In a quantum mechanical system, the energy associated with the emission and absorption of virtual particles. In a classical system, the energy associated with the interaction among parts of the system itself.

**self-organization:** (After Davies, *The New Physics*, 1989): "Spontaneous emergence of order, arising when certain parameters built in a system reach critical values." Simply put, self-organization is the spontaneous formation of patterns of localized order in a system that begins in a more homogeneous state. In short, the system moves from a simpler to a more complex state. Self-organization is one of the permissible features of an open system far from thermodynamic equilibrium with its active environment. Note that the localized orders represent free potential energy formations (free self-regauging) that in theory can then be dissipated in loads to perform free work. Hence the capability of a self-organizing system to perform some free work, or in other words to exhibit  $COP > 1.0$ .

**self-potential (e.g., of the electron):** The potential created in and of the charge (e.g., the electron) by its virtual particle flux exchange with the vacuum. Also, an asymmetry in the virtual photon flux of the vacuum, caused by the interaction of the charge (e.g., the electron) with the vacuum flux. From here, we note that the self-potential must consist of real observable 3-space EM energy flow or flows from the electron, because of the asymmetry. However, the charge is not the primary source *per se* of the energy flows that establish the self-potential, but instead is the asymmetric gate in the vacuum flux that "gates out" the potential and its energy **flux**. The asymmetry in the vacuum flux is the actual *source* or gate. Indeed, in

classical terms the energy is received by the charge in the form of converging longitudinal EM energy waves from the complex plane (from the time domain). The spin of the charges of the dipole transduces the absorbed complex EM energy into real observable EM longitudinal wave energy, and pours it out in all directions in 3-space. See discussions under Whittaker and phase conjugate.

self-targeting: Between two entities, where each acts partially or wholly as a phase conjugate mirror, self-targeting is the iterative phase conjugation or "ping-ponging" and rapid convergence of beams between the two PCMs.

S-flow: The Poynting energy density flow  $S$ , where  $S = E \times H$ . Heaviside's equation is given by  $S = E \times H + G$ . In the latter equation,  $E$  is the electric field,  $H$  is the magnetic field strength, and  $G$  is a trapped closed loop flow of energy density. Note that, from the very definitions of  $E$  and  $H$ , the Poynting energy flow represents only that portion of the total energy flow in a spatial region that is diverted by interception and interaction with charges. Heaviside's additional component  $G$ , which is not part of the field interactions but a result of the huge noninteracting part of the energy flow outside the interacted  $E \times H$  component, does appear to be responsible for an enormous unaccounted EM energy flow component that generates the excess gravity required to hold together the arms of the spiral galaxies.

signal wave: In nonlinear optics, the signal (wave) input to a phase conjugate mirror (PCM), that stimulates the PCM to emit a phase conjugate replica (PCR) wave in return. See discussion under distortion correction theorem.

Slepian current: The vector  $j\phi$ , which in a current loop represents the energy unit area per coulomb of flowing charge, per unit of time, that is collected/collecting from the Poynting  $S$ -flow and dissipated in that current loop in its loads and losses.

Slepian flow: "Flow of collected-energy density's dissipation" in a current loop, and therefore related to the vector  $j\phi$  in the current loop, which represents the energy per unit area per coulomb of flowing charge, per unit of time, that is being dissipated in that current loop in its loads and losses.

Slepian vector: Refers to the vector  $j\phi$  in a current loop, which represents the energy density per coulomb of flowing charge, per unit of time, that is being dissipated in that current loop in its loads and losses.

**solid-state parametric oscillator:** A parametric oscillator circuit employing solid-state devices. A parametric oscillator is a device that oscillates by rhythmically changing a parameter (such as capacitance or inductance, etc.). Simple switching between differing values of the parameter is often used to induce the periodic change of the parameter. One way of close-looping a  $COP > 1.0$  EM system is by using a bit of the positive output energy to do parametric switching, in effect converting the system to a self-oscillating energy flow system. The AC flow of EM energy is then much more easily intercepted, collected, and dissipated to power loads without killing the source dipole extracting and furnishing the free flow of EM energy from the active vacuum.

**soliton:** A "solitary wave" consisting of a wave pulse which propagates without changing its shape and without dispersion.

**source dipole:** Any dipole, considered from the viewpoint that real observable EM energy continuously pours out of it without any observable EM energy input. There is no true "source" as such in nature, since the energy is not created but only transduced and gated. In the case of the dipole and electrical charge as sources of EM energy, fields, and potentials, the broken 3-symmetry of the dipole initiates an automatic and more primary 4-symmetry, where EM longitudinal wave energy flows into the negative charge of the dipole from the time domain (complex plane), is transduced into normal EM longitudinal wave energy in 3-space, wherein the 3-space energy is absorbed by the positive charge of the dipole, transduced back into time-energy and reradiated back into the time-domain (fourth Minkowski axis). We roughly state that the dipole "emits observable EM energy" into all directions in 3-space as observable EM energy. However, what actually happens is that this *energy 4-circulation process* is what is emitted into and along 3-space, along every radial direction, with the process occurring at every spatial point along that direction. Any charge (taken together with its clustering virtual charges of opposite sign as a dipole) then inserted at any point in space along a radial line, will dipolarly intercept the ongoing process. We will observe the interception by its 3-effect on the intercepting and interacting 3-space charge, but we will not observe the 4-process itself. This deeper examination of the EM field-charge interaction requires a new interpretation of what is meant by "propagation of EM energy through 3-space", which is a non sequitur. Recall again Romer's acid objection **to the** totally illogical picture in every elementary textbook of the so-called "EM wave through 3-space" as a flat x-y plane orthogonal to the line of **motion** z, and where the E-field vector is oscillating along one axis while the

magnetic field  $B$  is oscillating along the other. That representation is totally false, just as pointed out so strongly by Romer.

spacetime or space-time: The entity represented by the "fused product" of space and time, to give "space x time". Spacetime is also dynamic

geometry, in the general relativistic interpretation. We may also consider spacetime to be a giant potential, and also active geometry, and also active vacuum, and also virtual particle flux of the vacuum, and also hidden EM wave flux. If we wish, we can also consider spacetime to be comprised of longitudinal EM waves and impressed dynamics.

spacetime curvature engine: Seed deterministic pattern and dimensioning.

special relativity: Einstein's theory of inertial frames in which, if two systems are moving uniformly in relation to each other, one cannot determine anything about their motion except that it is relative. Each of the two frames is said to be "rotated" with respect to the other, but not accelerating. The velocity of light in space (the vacuum) is constant, and is independent of the velocity of its source and the velocity of an observer. All the laws of physics are the same in all inertial frames of reference.

spin: The intrinsic angular momentum of a particle such as an electron, proton, neutron, photon, graviton etc., even when at rest, as if it were a top spinning about an axis, but had to spin 720 degrees before it turned "full circle." Spin is quantized, and is always described as a half or whole spin,

e.g.,  $-1$ ,  $-1/2$ ,  $0$ ,  $1/2$ ,  $1$ , etc. A spinning charged particle such as an electron thus demonstrates a magnetic moment, due to the circulation of charge in the spinning. In the nucleus of an atom, the spin of the nucleus is the resultant of the spins of the nucleons (particles comprising the nucleus).

spiral galaxy: A member of the class of galaxies having arms that extend in the form of spirals. About 70% of all galaxies are spiral galaxies: only about 10% of the gravity necessary to hold the spiral arms together can be accounted for by known gravitational sources. This has led to the

theorizing of dark (hidden) matter of exotic and unknown form, which would be responsible for the excess gravity. Later it was theorized that some sort of "dark energy" might be responsible for the extra gravity. The

present author has proposed that the *unaccounted* enormous Heaviside component of the EM energy flow surrounding every field/charge interaction, and not entering into that interaction, is the missing source of the excess gravity. The dark Heaviside energy flow was arbitrarily

discarded by Lorentz in the 1890s, and it is still discarded today by all electrodynamicists and astrophysicists.

**Stoney, George Johnstone:** Well-known scientist (1826-1911) who first estimated the value of the electronic charge (1874) and was the first to advocate the particle nature of electricity. In 1891, he named the unit of electronic charge the *electron*. In 1896-7 he laid the foundation for Whittaker's 1903 bidirectional wave decomposition of the scalar potential.

**string wave or "plucked taut string" wave:** The transverse wave on a taut string produced when the string is plucked. The string wave itself stays on the string and does not travel through the slapped external medium.

**subspace:** In vector mathematics: a subset of a vector space which is closed under vector addition and scalar multiplication operations. In the new approach, we may consider the active ambient vacuum as a giant scalar potential. This ambient potential then decomposes into longitudinal EM waves via Whittaker's 1903 decomposition. One can then refer to longitudinal EM waves deliberately transmitted "inside" that Whittaker "subspace" as "subspace communication". The Fogal semiconductor is able to infold normal EM signals into such subspace signals (longitudinal EM wave signals) in the transmitter, and to outfold the longitudinal EM waves back into normal EM waves in the receiver. Hence the Fogal semiconductor can be utilized to perform subspace and superluminal communication. These capabilities have been demonstrated by Fogal in **the** laboratory. As this is being written, Fogal is in serious negotiations with several large companies for the funding to get his chips into volume production and onto the marketplace in very sophisticated and advanced equipment representing a great leap forward in technology. There are, however, powerful interests who do not wish the Fogal semiconductor to ever be produced and marketed. We have worked with Fogal for some years, and — once the semiconductors are available in quantity — we **will** be developing and marketing COP>1.0 electrical power systems utilizing his semiconductors and technology, under license from Fogal.

**superconductivity:** Property of some materials or metals whereby at **very** low temperature their resistance reduces to zero. These materials also exhibit many additional properties that are anomalous compared to **normal** materials. Much research has gone into the attempt to find materials that exhibit superconductivity at higher temperatures, with the goal of **reaching** room-temperature superconductivity. Room-temperature superconductivity is also just COP = 1.0. EM systems far from equilibrium with the active

vacuum, and which exhibit  $COP > 1.0$  at room temperature, may involve most of the odd entities also observed in superconducting materials (polarons, lattice holes and hole currents, Dirac sea holes and Dirac sea hole currents, "charging" by Dirac sea hole excitation, vortices, etc.) The energy density in the output section is greater than the energy density input by the operator to the input section. Considering the giant negentropy mechanism and the dipolarity of the input and output sections, the tempic potential of the output section of a  $COP > 1.0$  EM system is greater than the tempic potential of the input section. Hence there is a tempic gradient across the entire system, and a tempic force from output to input. This may "sweep" out a great deal of the produced "superconductivity" entities, and particularly may result in a Dirac sea hole current in the vacuum, out of the input section back into the external power source, as a novel output of the  $COP > 1.0$  system. Feedback from output to input may also be in the time domain, corresponding to what Gabriel Kron referred to as the "open path". By recombinations and other means, the feedback in the tempic domain may be transduced in the input section of the device to ordinary current in forward time. When the voltage and current in this transduced tempic feedback are properly adjusted to that being supplied from the external power source, the external source can be disconnected and the  $COP > 1.0$  system becomes self-powering, while simultaneously powering its load also.

superluminal: Exceeding  $c$ , the speed of light in vacuum. Longitudinal EM waves can travel either slower or faster than the speed of transverse wave light in vacuum. See W. A. Rodrigues and J.-Y. Lu, "On the existence of undistorted progressive waves (UPWs) of arbitrary speeds  $0 < v < \infty$  in nature," *Found. Phys.*, 27(3), 1997, p. 435-508; W. A. Rodrigues and J. Vaz Jr., "Subluminal and Superluminal Solutions in Vacuum of the Maxwell Equations and the Massless Dirac Equation," *Adv. Appl. Clifford Algebras*, Vol. 7(S), 1997, p. 457-466.

superluminal communication: The movement of intelligent signals faster than the speed of light in vacuum, and the transmission and reception of such signals and extraction of their transported information. Longitudinal EM waves are not limited to speed  $c$ , whereas transverse EM waves are. The infolded electrodynamics inside all EM fields, potentials, and waves consists of longitudinal EM phase conjugate wave pairs, with their impressed dynamics. Hence this "subspace" is a superhighway for such waves, including those moving at superluminal velocity. In essence this is a very special kind of "tunneling" which might be referred to as *subspace tunnelling*. The limitation to light speed rigorously applies to the modeled



transverse EM waves which are a sort of "bulk upheaval" waves similar to waves on the surface of the ocean. As in the ocean wave analogy, "pressure" waves underneath the ocean may travel very much faster than the bulk upheaval waves on the surface.

When making longitudinal EM waves, the process is imperfect and the resulting longitudinal EM waves will have a transverse residue as well. The resulting "transverse-noisy" LW is called an undistorted progressive wave. Undistorted progressive waves may move slower than the speed of light or faster than the speed of light. The degree of transparency of matter to LWs is an inverse function of the "transverse-noisiness" of the LWs.

**superposition:** The simple linear addition and subtraction of two or more values, states, etc.; one of the key principles in field theories and in the concept of potentials. When the situation is sufficiently nonlinear, however, interaction of waves and potentials occurs instead of simple superposition.

**supersystem:** A higher level or "metasystem" of interactions between **the** classical system, the active vacuum, and the active local curvatures of spacetime. Hence the supersystem consists of three interacting components: (1) the EM system and its dynamics, considered in conventional fashion as if the local vacuum were inactive and the local spacetime were flat; (2) the local interactive vacuum and its dynamics, and (3) the local curvatures of spacetime and their dynamics. In component (2), one must consider the Dirac sea, Dirac holes and hole currents, with concomitant potentials and forces impressed on them. In component (3), the time-domain interactions (time-energy, time-force, time-potential, **and** currents of energy along the fourth Minkowski axis) must be accounted to include negative energy.

All three components of the supersystem interact with each other. In general, the vacuum interactions may be taken from particle physics, and the spacetime curvature reactions may be taken from general relativity. However, this will yield only a rough or "first order" analysis, since it does not produce the tri-reactions of all three components at once, but mostly reactions between pairs of the components. The concept is easy to conceptualize, however, and yields valuable clues and insight in many areas, such as chemistry (including biochemistry), electrical physics, electrodynamics, thermodynamics, and electrogravitation. It is particularly useful in understanding the phenomena encountered in COP>1.0 EM power systems.

symmetrical re-gauging: In electromagnetics, changing the scalar potential to a different value, and simultaneously changing the vector potential to a different value, with the two changes precisely selected so that the two extra forces (each created by one of the changes) are equal and opposite — thus canceling each other's effect with respect to bulk translation and doing no net *external* work. The two forces remain and can perform internal work upon the system. Note that the stressing effect of the two new forces is not canceled, and that the stress of the system is altered a priori. See re-gauging.

tantalum capacitor: Electrolytic capacitor with a tantalum or sintered-sluganode, such as a solid tantalum, tantalum-foil electrolytic, or tantalum-slug capacitor.

targeted pinpoints: Those separated points which engage in self-targeting between themselves and some separated signal energy source (as in Fogal's semiconductor). The effect is to sharply narrow the retroreflected source signal energy from the source onto the separated points by means of the mutual ping-ponging. In this fashion much more energy density from the source can be concentrated on the targeted pinpoints. In effect, *phase conjugate shooting* — the return of the phase conjugate reflected scattered energy directly to the original target emitting the signal wave in pinpoint fashion - is evoked. See distortion correction theorem.

tensor: A special mathematical entity which is a generalized vector element of a vector space, with more than three components, each of which is a function of the coordinates of an arbitrary point in space of an arbitrary number of dimensions.

Tesla, Nikola: Famous American emigre electrical engineer, inventor and eccentric (1856-1943), whose numerous inventions fueled much of the electrical 20th century. In essence he produced the AC system, including polyphase systems. Also, Tesla invented radio transmission, not Marconi, according to a U.S. Supreme Court decision that upheld the prior patents of Tesla over Marconi. In his famous experiment, Marconi in fact utilized a variation of one of Tesla's circuits. This does not denigrate Marconi's many accomplishments, but just sets the record straight on who invented radio transmission. The impetus to the development of commercial radio transmission technology and the industry itself came from Marconi.

*thermodynamic equilibrium*: Stable state eventually reached by an isolated system or one in a well-behaved active environment. One may consider it a "balanced" or "preferred" state. It is important to note that, in particle physics, there can be no equilibrium of a mass system unless the

vacuum interchange with that system is considered. Electrodynamics mistakenly continues to omit the active vacuum interaction with a Maxwellian system, hence is seriously flawed in that respect.

**thermodynamics of open systems:** Systems far from thermodynamic equilibrium with an active environment are permitted to exhibit five "magic" functions. Such a system can (1) self-order, (2) self-oscillate or self-rotate, (3) output more energy than the operator himself inputs (the excess energy being freely received from the active environment), (4) power itself and its load simultaneously (all the energy being freely received from the active environment), and (5) exhibit negentropy.

**time:** In our view, time is spatial EM energy compacted by the factor  $c$ . Time thus has the same energy density as mass, but in the time domain rather than in the 3-space domain. Also, time is not observable *a priori*; mass is an observable. Time persists since it is persistence itself. No observable persists *a priori*, since observation is a  $d/dt$  operator imposed upon LLLT spacetime, yielding a frozen LLL snapshot which does not even exist the very next instant. When we say "mass exists in time" (or any observable continuously persists), we are unwittingly invoking a very rapid iterative  $d/dt$  operator repeatedly, and recalling these iterative sequential "frozen snapshots" or observations from memory. One may produce and utilize EM energy flow in the time domain, as in 3-space. Time, being energy and energetic, has tempic potential (energy density), tempic potential gradients, and therefore has "tempic force." The photon is composed of both spatial energy and time-energy as its two canonical constituents. The lower the frequency, the higher the energy of the photon when the time-energy is considered, since the magnitude of the time-component of the photon increases as the spatial energy component decreases, and the energy of the photon in that case increases as  $c^2$  times the increase in time magnitude, while decreasing linearly proportional to the decrease of the spatial energy magnitude. When transduction of time into spatial energy occurs, or vice versa, the energy conservation law is modified to specify the sum of the spatial energy, time-energy, and mass energy.

**time-charge, time charging:** Since time is a special highly compressed form of energy, then time-excitation or *time-charging* also occurs. Also, since tempic longitudinal EM waves accompany all longitudinal EM waves (per reinterpretation of the phase conjugate half set of the Whittaker decomposition), then irradiating a mass with substantial longitudinal EM wave radiation will time-charge the mass, exciting it with time-energy. There are excited states and internal structuring (engines) in time **charging**.

much like the excited states and internal structuring (engines) in energy excitation of normal charge. When the longitudinal EM wave radiation is removed, the time-charged entity then slowly emits longitudinal EM wave radiation as the time-excitation slowly decays via the giant negentropy process of the charges.

time-energy: Time may be considered as spatial EM energy compressed by the factor  $c^2$ . See also discussions under time and time charging.

time excitation: See time charging.

time-flow generatrix (mechanism): Since any observable is a frozen nonpersistent snapshot in 3-space, then the common expression "flow of a mass through time" requires an active generating mechanism to add time to mass, converting it to mass time, which is persistent. Mass time  $mt$  is as different from mass  $m$  as impulse ( $Ft$ ) is from force  $F$ . The flow of a mass through time is generated by the ubiquitous interaction of photons with the mass. This includes all photons, both virtual and observable. Thus for the ambient vacuum, there is an ambient flow of time, since there is an ambient rate of total photon interaction. The "macroscopic" movement of the mass through time is the result of (i) absorptions and emissions of observable-sized photons, and (ii) the continuous integration of virtual photon absorptions into observable-sized photons. The macroscopic flow of time thus has myriads of "sublevels" of infolded time flows and engines. Hence the flow of time has a marvelous, internal, dynamic structure.

time-forward: Refers to the flow of an entity through time in the forward direction, as seen by an external observer. Time-forward flow occurs when (to the observer) there is a predominance of time-forward photons interacting with the body that is moving in forward time. Contrast to time-reversal of an object, as seen by the external observer, which occurs when (to the observer) there is a predominance of time-reversed photons (antiphotons) interacting with the body that is observed to be time-reversed. Pumping a given living mass (in the nonlinear optical sense) with time-reversed EM waves pumps the object in the time domain. That dramatically extends nonlinear optics, since the pumped living object's cells will be observed to slowly reverse back to a previous physical state or condition. Since time-polarized EM waves accompany all longitudinal EM waves via reinterpretation of Whittaker 1903, pumping a living mass (a body) with longitudinal EM waves also pumps it with time-polarized EM waves, time-charging the body which continues the pumping in the time domain after the longitudinal EM wave radiation is removed.

time-forward EM wave: A normal EM wave moving in forward time as seen by the observer. Otherwise known as the retarded wave. The external observer comfortably sees its forward progress as expected.

time-polarized electromagnetic wave: An electromagnetic wave whose vibrations occur in the time domain only. May be referred to in a quantum field theory sense as a *scalar* EM wave. It is a longitudinal EM wave in the time domain. It may also be said to be a longitudinal EM wave in the complex plane, since in Minkowski space the fourth axis may be taken as  $-ict$ . The time-polarized EM wave is indicated in quantum field theory, or at least its time-polarized photon is theorized and called a "scalar" photon.

time-polarized photon (scalar photon): A photon whose vibrations occur in the time domain only, also known as a "scalar" photon. This polarization of the photon is utilized in quantum field theory. Neither the scalar photon nor the longitudinal photon is individually observable. However, the combination of the two in the presence of charge is observable as the instantaneous scalar potential.

time reversal: For EM waves, the process of forming the phase conjugate wave. For a particle or a mass, the process of pumping the particle or mass with time-polarized EM waves, so that the resident spacetime curvature engine in the mass is amplified and phase conjugated, forming a precise, amplified antiengine which then slowly time-reverses the mass back to a previous physical condition and state. We accent that *time reversing a single object or single group of objects* is not the same thing as "travel into the past" so popularized by science fiction. For time travel to the past, the entire universe and everything in it — except the traveler — would have to be time-reversed. That would not seem possible by any stretch of the imagination today! On the other hand, time-reversal of a single thing such as a particle or a wave — or even a group of things such as a group of particles or waves — is not only feasible but is readily achievable. A Dirac sea hole is a negative energy electron, for example, having negative energy and therefore negative mass prior to observation. After observation, it is seen as a positive energy, positive mass electron of opposite charge to the conventional electron and reacting with fields in opposite direction from the conventional negatively charged electron. In short, after observation (interaction with mass) it becomes the positron.

time reversal zone: A region of space in which the majority component of the overall time flow mechanism runs backwards, and hence the fundamental mechanism generating the flow of a mass through time is reversed. The "time running backwards" is due to the predominance of

interactions with antiphotons. It follows that, in the time-reversal zone (TRZ), there is a predominance of antiphoton interaction over photon interaction. In a TRZ, the law of attraction and repulsion of charges is reversed; like charges attract and unlike charges repel. Also, induced action by the time reversal forces start *inside and throughout* an affected mass in that zone, originating at every point in that local spacetime zone and moving outward. It thus involves a novel action "from inside to outside", beginning even inside the nucleons, and first affecting the quarks and gluons. Deliberate use of time-reversal zones and their subsequent decay allows a great new class of dramatic nuclear reactions, including simple transmutation and loosely called "cold fusion" reactions, at low spatial energy but very high time-energy. High energy physics has neglected the use of time-energy, opting to go for high spatial energy. Hence the high energy physicists have actually eliminated a much higher energy physics (at low spatial energy so readily examined on the bench far *more cheaply*) than the science they have long developed.

time-reversed wave: A phase conjugate reflected wave, which is a wave moving in reversed time. Since the external observer "sees" in forward time only - and even then he sees in an iterative series of frozen 3-space snapshots — he *observes* the time-reversed wave as a 3-spatial wave (series of iterative frozen snapshots) traveling in the opposite direction as its generatrix wavefront (the *signal wave*).

topological: Invariant under transformation by continuous mappings, or related to the properties of geometric shapes and figures that remain invariant under transformation by continuous mappings.

topological properties: Those properties of a geometrical space that are unchanged by continuous distortion of the space.

topology: Mathematics of the properties of geometric configurations invariant under transformation by continuous mappings. In short, the mathematics of the large-scale structure of curved spaces.

transverse (with respect to waves): Wave oscillatory movement perpendicular to the wave's primary direction of principal propagation, as in the movement of a plucked taut string in a wavelike motion traveling down the string but with the oscillations being lateral. Based on Faraday's notion that the field lines of the electromagnetic field were physical material lines (in the material ether) similar to taut strings, Maxwell assumed the transverse wave model in his theory. The entry of longitudinal waves, into the theory can easily be demonstrated by rhythmically and coherently varying the magnitudes of the Lorentz symmetrical regauging

condition, producing "stress potential waves" which are in fact what longitudinal EM waves really are. The production of a longitudinal EM wave in 3-space will be accompanied by the simultaneous production of a time-polarized companion wave.

**tunneling:** In quantum mechanics, a phenomenon in which a particle penetrates and crosses a small region where the potential opposing such passage is greater than the particle's available energy. The phenomenon is thought to be impossible according to classical physics, but occurs nonetheless. Further, the speed of transit through the "tunneling" separation can be superluminal. Tunneling of music between two separated points in a waveguide has been measured at more than four times the speed of light.

A more extended type of tunneling is the travel of longitudinal EM waves infolded inside the normal EM potentials, fields, and waves. Indeed, this is a more fundamental electrodynamics, and it can be shown that interferometry of this "internal" electrodynamics creates the external electrodynamics by a form of longitudinal EM wave interferometry. E.g., see M.W. Evans, P.K. Anastasovski, T.E. Bearden *et al.*, "On Whittaker's Representation of the Electromagnetic Entity in Vacuo, Part V: The Production of Transverse Fields and Energy by Scalar Interferometry," *Journal of New Energy*, 4(3), Special Issue, Winter 1999, p. 76-78. This is part of the technical basis for the "scalar interferometry weapons" developed by the Russians after World War II. Today, some 10 nations have such weapons, more are developing them, and even the Japanese Yakuza has such weapons.

**unified field theory (engineerable):** A unified theory of the four forces of physics — the electromagnetic, gravitational, strong, and weak forces that is not just an intellectual model but which is also engineerable on the laboratory bench and in actual physical systems using higher symmetry  $O(3)$  electrodynamics as a special subset of Sachs' unified field theory.

**unitary  $Q_E$  (charge of the electron):** Fixed or unit charge  $q$  of the electron. This notion is held because  $q$  is not decomposed into its component elements, but treated as if it were an indivisible unit, charge and mass and all. The mass of a fundamental particle at rest is quantized, and the massless charge (self-potential) of the particle is discretized as a function of the background potential (virtual particle flux density) in which it is embedded or to which it is exposed. In our view the definition of a charge  $q$  is  $q \equiv m_q \phi_q$ , at least to first order. (The  $\phi_q$  may be internally structured with deterministic "engines", so that one electron need not be

identical to another, in its actions in some cases). The *electrical charge* of the "charged mass  $m_q$ " should be taken to be the massless  $\phi_q$  component. For an electron,  $q_e \equiv m_e \phi_e$ . The *electrical charge* of the electron should be taken to be the massless  $\phi_e$  component. We note that the charge is also structured, since  $\phi_e$  or  $\phi_q$  decomposes via Whittaker 1903 into a harmonic set of EM longitudinal phase conjugate wavepairs. Our reinterpretation of this decomposition then yields the solution to the problem of the "source charge" and its associated fields and potentials and their energy. The massless charge  $\phi_e$  is a dipolarity and hence a broken 3-symmetry in EM energy flow, invoking a more primary 4-symmetry in EM energy flow so that EM longitudinal wave energy is continuously incoming from the time domain, being absorbed by the charge  $q$  of which  $\phi_e$  is a component, being transduced into real EM energy in 3-space, and emitted in all directions in 3-space at the speed of light, creating the fields and potentials and their energy that are associated with charge  $q$ . If a charge (say, an electron) is placed in an additional potential  $\phi_1$ , then the total massless charge of the electron (i.e., its virtual vacuum flux exchange with mass  $m_e$ ) is  $(\phi_e + \phi_1)$ .

As can be seen, the massless charge of the electron (its virtual flux activity) has now changed. The electron is then said to *be collecting and to have collected* excess energy (which may be either positive or negative, depending upon the sign of  $\phi_1$ ). Further, either  $\phi_e$  or  $\phi_1$  or both can be internally and deterministically *dimensioned* (structured in Stoney-Whittaker-Ziolkowski fashion). When its massless charge (its own  $\phi_e$ ) potential is soidimensioned, then the dimensioned electron is said to contain or transport an *engine* or a *vacuum engine* or a *spacetime curvature engine*.

vacuum: Space devoid of observable matter. In modern theory, the "empty" space is in fact bristling with very rapid fluctuations of EM energy, remaining in the virtual state. It is also filled with a violent, fluctuating flux of virtual particles, appearing and disappearing so quickly that an individual particle does not persist long enough to be individually detected. Thus the vacuum is extraordinarily energetic, but the energy is in very special form (fleeting violent fluctuations and virtual particle flux). Nonetheless, because it contains enormous energy, the *average* vacuum may be considered a potential. All potentials then are changes to this vacuum potential, or to an intermediate potential which is a change to it. In another sense, the vacuum, potential, and spacetime are all one-and-the-same thing. This means that general relativity's spacetime curvature is ubiquitous and extraordinarily dynamic. The vacuum very near a mass also can act in some cases as a semiconductor, capable of supporting self-



oscillation between the mass and the local vacuum. Considerations of the active vacuum and its nature lead to the notion of the *supersystem*, which is comprised of three parts: (1) the physical system and its dynamics, (2) the active vacuum and its dynamics, and (3) general relativity and its dynamics (since physicists persist in separating the notions of spacetime and vacuum). No analysis of any mass system is complete unless an analysis of the entire supersystem and the interactions of the three components, one with the other, is performed.

Every charge is "embedded" in the active vacuum by its potentials and fields, which themselves are spacetime curvatures and alterations of the local vacuum. This is easily seen by  $q \equiv m_q \phi_q$ , where  $\phi_q$  is a change to the local vacuum potential *a priori*. In the quantum view, the fields and potentials may be taken as organized polarization patterns and dynamics (currents) in the vacuum virtual particle flux.

vacuum engine: Also referred to as a *spacetime curvature engine*. From the particle view: a deterministic internal pattern or *template* deliberately created as a deterministic structuring and dynamics in the virtual flux comprising a scalar potential. It can also be created in, and transported by, the two scalar potentials that comprise a static or dynamic force field, or a moving EM wave in the vacuum. It can also be created in the local vacuum potential, in which case it has a "charge-up" creation time and a "discharge time," exhibiting a sort of "time constant" very much like a capacitor charging and discharging.

In the wave view: the vacuum engine is a deterministic internal pattern or template deliberately created in the Stoney-Whittaker-Ziolkowski internal biwaves and wave products comprising the scalar potential. Again, it can be implanted in the vacuum or in an EM signal as a carrier. The self-energy (scalar potential) portion of any electric charge or magnetic charge can also be a "carrier" that is conditioned *{dimensioned}* with a vacuum potential. The process or act of conditioning any of the carriers with vacuum engines is called *dimensioning* that carrier. Russian energetics used in secret weapons programs refers to the vacuum engines of a dimensioned carrier as the *information content of the field*. Such vacuum engines, e.g., were used in the potentials of the microwave radiation of the U.S. Embassy in Moscow for several decades, inducing a variety of health changes and sicknesses in the personnel of the embassy. Interestingly, all these health changes occurred in the field-free regions of the Embassy. There the field-free potentials existed and were stable and unchanging. Hence a body exposed in that region was steadily exposed to the specific engine being induced, and time-charged with that engine accordingly. The

deterministic set of spacetime curvatures comprising this charge then acted upon the cells and body to slowly change it to the damaged or diseased condition. See dimensioning.

**vacuum flux exchange:** The virtual particle interaction between the active vacuum and a mass, particularly a charged particle.

vacuum's **virtual particle flux:** In the particle viewpoint, the quantum mechanical vacuum identically is a virtual particle flux. Present physics, however, is prone to refer to the vacuum as an implied emptiness containing a virtual particle flux, even though that is known to be in error. In **our** view, energy, vacuum, spacetime, virtual particle flux, and dynamic geometry are all synonyms. One must note that the ageless contradiction of the wave vs. particle view has still not been resolved in physics, even by the duality principle. The duality principle is merely an agreement to quit fighting, and to feel free to consider a thing a particle in one case or circumstance and a field in another case or circumstance, *whichever works*.

**vector:** In mathematics, an entity completely characterized by a magnitude and a direction.

**vector potential:** A potential having — at any point in it — both direction and magnitude. The direction, e.g., may be linear, curvilinear, or swirling. The term "vector potential" is often used as the magnetic vector potential A. When it is swirling, the magnetic vector potential A may be said to be the **magnetic** field B. However, the swirling magnetic vector potential (the **magnetic** field B) may be "bottled up" and contained locally inside a long tight solenoid, or inside a toroidal coil, or inside a special nanocrystalline **material** used as a closed transformer core as in the motionless **electromagnetic** generator. In that case nature freely replenishes the energy in the surrounding space which would have been occupied by the **nonrestricted**, nonlocalized B-field (curled A-potential) but replenishes that **space** with an uncurled (linearly flowing) magnetic vector potential A. This in fact at least doubles the available energy flow available, without any additional EM energy input by the operator. The well-known Aharnov-Bohm effect clearly demonstrates this effect, and it is **deliberately** employed in the motionless electromagnetic generator (MEG) of **which** the author is one of the five co-inventors. Present dictionaries of physics and many textbooks are confused as to the definition of magnetic vector potential A and its relation to B, many stating that the A is defined by the equation  $\nabla \times \mathbf{A} = \mathbf{B}$ . However, no equation is a definition; it is an **expression** of equality of two magnitudes, and not a definition of either side. If we substitute the more stringent  $\nabla \times \mathbf{A} \equiv \mathbf{B}$ , we see that the  $\nabla \times$

operator acting upon the A potential is precisely what a B field *identically is*. Hence the A potential exists in two forms: (1) in curled form as identically the B-field, and (2) in uncurled field-free form as the linearly moving A-potential energy current that has no imposed  $\nabla \times$  operator and thus has no curl. This makes total sense with  $\nabla \times \mathbf{A} \equiv \mathbf{B}$ .

**vector field:** Conventionally, the assigning of a magnitude and a direction (that is, a vector) to each point in a region of space occupied by a field. In our view the field is in fact a change to the active energetics of that spatial region, such that the region will interact with any appropriate entity (e.g.,  $\mathbf{a}$  charged mass) placed at any point in the region and produce a force upon that entity.

**vector zero:** See discussion under zero vector.

**virtual antiphoton:** An antiphoton that spontaneously appears and disappears, so swiftly that it cannot be individually observed. It is real while it exists. Coherent integration of a stream of virtual photons, however, adds to produce an observable quantum of energy, which is observable in its effects on a charged particle.

**virtual particle:** A fleeting quantum particle that spontaneously appears and disappears, so swiftly that it cannot be individually observed, so that it exists only temporarily. It is real while it exists. The virtual particle does not satisfy the usual relation between energy, momentum, and mass because it is under the aegis of the Heisenberg uncertainty principle. The virtual particle can have any amount of energy momentarily, so long as the product of its energy and the time interval of its existence is less than the uncertainty principle's minimum magnitude.

The coherent interactions of large numbers of virtual particles with a **mass** or charge can combine to generate real observable effects (forces). In quantum field theory, all forces of nature are caused by the interaction of the mass entity with virtual particles. Interaction of a mass with virtual photons, e.g., is projected to cause all mechanical and electromagnetic forces.

**virtual particle flux exchange:** Interaction with or exchange of a flux of virtual particles.

**virtual photon:** A photon that spontaneously appears and disappears in the vacuum so quickly that it cannot be individually observed.

**virtual photon flux:** See definitions under **flux** and under **virtual particle**. For electromagnetics, the vacuum can often be modeled as a flux

of virtual photons. One gets the virtual charges also, since the photon is also considered to consist of a positron-electron pair. That is, the photon is continually separating into a positron-electron pair, whose particles then annihilate each other to form additional photon(s), etc.

virtual photon flux exchange: The mutual exchange of virtual photons, as between the vacuum and a charged mass, or between two colliding masses.

**virtual** photon flux of vacuum: In our view, the vacuum identically is a flux of virtual particles. For many electromagnetic cases, it can just be modeled as identically a flux of virtual photons, where the word "photons" in general usage refers to both photons and antiphotons.

virtual positron: A positive electron (positron) which spontaneously appears disappears in the vacuum so quickly that it cannot be individually observed. More accurately, in the 4-vacuum, a negative energy electron state that spontaneously appears and disappears so quickly that it cannot be individually observed. A virtual Dirac sea hole.

Whittaker, Edmund Taylor: Well-known English mathematician and physicist, 1873-1956, who made major contributions to mathematics and physics. Whittaker dramatically extended Stoney's earlier work of 1897-8 and authored two papers in 1903 and 1904 giving the basis for the theory of scalar electromagnetics (Russian energetics, not including the quantum potential portion). His decomposition of the scalar potential into a harmonic set of longitudinal EM wavepairs, where each pair is a phase conjugate pair, may be reinterpreted to solve the long-vexing problem of the source charge or source dipole and its continuous emission of EM energy in 3-space, providing its associated potentials and fields and their energy. The problem was solved by the present author's reinterpretation in that manner, published in 2000. This was later found to be consistent with quantum field theory as well, by interpreting the observability of the combined scalar and longitudinal photon pair as opposed to the nonobservability of either the scalar or longitudinal photon individually.

Work: The changing of the form of energy. One joule of energy whose form is totally changed in a reaction, does one joule of work in that reaction. However, it is strongly stressed that after that joule of work is performed, one still has a joule of energy left to use (with which to do additional work). This remaining joule of energy is just in different form than was the initial joule of energy. So one can do joule after joule of work from a single *initial* joule of energy, so long as the energy is not dissipated and lost after each change of its form. In any one single change of form, only **one** joule of work can be done from one joule of energy. So energy is

conserved through many changes of form, but work is not. To work in COP>1.0 systems, one absolutely must root out from one's consciousness the mistaken notion that only one joule of work can be done from a joule of input energy. One of the places where extra joules of work are performed by each joule of energy is that of strong gradients. Strong gradients are known and recognized to violate thermodynamics. Work is further divided into **internal work** and **external work**.

**work, external:** The changing of the form of the collected energy of a body or system by dissipating it upon an external load or entity is the external work *done by* a body. The changing of the collected energy of a body or system by performing work upon it is the external work *done upon* a body or system.

**work, internal:** The changing of the form of the internal energy of a body or system. It may also involve the changing of internal parts of the system.

**work-energy theorem:** In mechanics, a theorem that the change in kinetic energy of a particle in motion is equal to the work done by all the forces acting upon the particle.

**zero-point energy:** The energy remaining at a temperature of absolute zero, due to the Heisenberg uncertainty principle and the quantum mechanical theory of an oscillator. Also, the minimum energy of a system due to its quantum fluctuations, resulting from its incessant virtual particle activity. Quantum mechanically, no system of interest (including even spacetime itself) can have zero energy. The zero-point energy of the vacuum is the lowest energy vacuum state, with fluctuations taken into account. Even at low energies, quantum fluctuations continually arise, and result in an incessant, extremely rapid, and violent "jittering" of the energy momentarily present. The minimum energy due to these quantum fluctuations is called the *zero-point energy*.

**zero vector:** Candidates are: (i) A vector having no length (no magnitude) or specific direction; (ii) absence of any and all finite vectors; (iii) resultant of a system of multiple, finite vectors whose vector sum has **no** specific direction but may have nonzero scalar magnitude.

The second definition differs drastically from the first. That is, we **cannot** say that a vector resultant zero has no infolded magnitude, if we **consider** its nonzero components, all of which have magnitude. (See the discussion under **zero**). It only has no net magnitude for *translating* force. It is, in fact, *a stress potential*, and it is one with a deterministic internal structure or *engine*. By rhythmically and coherently varying each component of a

zero vector system, one easily produces longitudinal EM waves,, each of which is accompanied by a correlated time-polarized EM wave. In vector analysis, the zero vector axiom states that any vector  $v$  plus a zero vector is **equal** to a zero vector plus  $v$ . Note that, being an axiom, this is not proven, but just assumed for any zero vector. We very much disagree with that blanket axiom; it reduces vector analysis to a highly special single case, where all zero vector systems are to be considered equal, and totally "inactive." That is true only for bulk translation. In the real world that need not be true at all; specifically, it is not true for two different zero vectors having different internal structure and dynamics (different internal engines).

There are an infinite number of different zero vector resultant systems, and so zero vectors may differ, if their infolded component "substructure" is considered. In the real world, things that are vectors very often have energy. The energy is infolded and hidden, so that it represents not only (i) a local curvature of spacetime, but also (ii) a structured, deterministic set (a template) of curvatures of local spacetime. Therefore this zero vector system is actually a *vacuum engine*. Any mass system placed in such a potential, will be acted upon in its internal parts by that local vacuum engine; in short, it will have internal work performed on its interior. Further, the zero vector resultant system is a "stress potential," since it does contain "collected internal energy."

So between zero vector resultant systems, the "infolded, hidden energies" differ dramatically in (i) total infolded and trapped (collected) energy, (ii) specific internal action patterns (templates), (iii) general relativistic effects, and (iv) type of engine. Accordingly, the actions the zero-vector system induces in an exposed mass may be designed in advance. This is vacuum engineering. This spacetime engineering. This is the formation and use of engines. It is also one of the bases of Russian energetics.

The problem is the *vector algebra itself*. In the abstract algebra, a "vector space" is regarded as an inert thing, where the only actants are the overall net nonzero vectors, and there is no interaction between an overt vector and a covert set of vectors. The vector space is not allowed to have an internal realm, stress, hidden engines, or to interact with the vectors representing the physical system. So vector algebra lacks the capacity to model such higher topology phenomenology. Consequently, for over a century electrodynamicists — thinking primarily of spatial translation — have routinely discarded such "zero vector systems" as if they represented the total absence of any finite vector. *This they do, in the unsuitable*

*assumptions of the vector algebra.* This they do not do, in the real world, whether we are aware of it or not.

The common practice in electrical physics of replacing a zero-summed system of nonzero vectors with a vector zero indicating a "complete absence of vectors" is very much incomplete. This present practice should be changed; it has reduced the topology of electromagnetics far too much, and gutted vast, important parts of the theory insofar as an extended electromagnetics is concerned. The vector zero should be replaced with a special organized vector zero system and a dimensioned scalar potential.

The interactions of the "hidden" vectors — the *engines* — should be incorporated. By failing to do this, physics excludes the ability to engineer electrogravitation, spacetime, the virtual state, local general relativity, free energy, effects at a distance, and the probabilities of the states propagated by the Schrodinger equation. It also excludes unification of forces. As another more human example, for every cellular disease condition there is a specific engine resident in the cells. An amplified antiengine for that disease pattern can fairly readily be generated. That antiengine, embedded in ordinary EM fields and potentials, can be irradiated into a diseased body with that disease, and it will time-reverse those diseased cells slowly back to normal. This is actually the basis of the body's own healing system the cellular regenerative system studied mostly by Becker. Unwittingly using this "antiengine" approach, Priore and a team of French scientists provided startling cures of terminal cancers, infectious diseases, clogged arteries, etc. in laboratory animals in France in the 1860s and early 1970s. The work is strongly documented and replicated in the French scientific literature, but the work was suppressed in the early 1970s in the change of the French government. See our "porthole briefing" on our website [www.cheniere.org](http://www.cheniere.org) for our extension of the Priore method, for greater ease portability, and rapid treatment of mass casualties.

In the new view, a zero vector may be a system of nonzero vectors that vectorially sum or multiply to zero for spatial translation purposes, but nonzero components may still exist "inside" and dynamically function inside the zero-resultant envelope. This substructure can act on nonlinear or resonant systems. Any or all of the nonzero components may be time varying, or none of them may be. The zero vector system may thus be a dynamic engine and a dimensioned scalar stress potential. In addition, such a vector zero system is considered to be also a scalar stress potential, whose magnitude is equal to the sum of the absolute values of the components. In addition, a separate type of stress potential may be included for the magnitude of the absolute values of the swirl components

(torques). Other associated potentials may be included for the system, particularly if the system is in multiple dimensions, if it consists of more than one type of virtual particle flux, if several fluxes intercommute, etc.

zero vector summation systems: Zero summations of real, nonzero vectors, so that the real vectors are still present but do not cause *spatial translation* of the exposed mass or charges. Instead, the zero vector summation has an internal structure and dynamics, hence an internal engine. Also see discussion under zero vector.



## Appendix A

### Relation to Equilibrium and Disequilibrium Thermodynamics

*"The second law [of thermodynamics] does not rule out the possibility of pushing heat uphill, as it were, from a cold object to a hot one, or of creating order out of disorder. It merely states that such a reversal of the natural flow requires an influx of energy..."* [Raymond Serway] {697}

*"It is in no way possible, either by mechanical, thermal, chemical, or other devices, to obtain perpetual motion, i.e., it is impossible to construct an engine which will work in a cycle and produce continuous work, or kinetic energy, from nothing."* [Max Planck] {698}.

*"What might appear to be empty space is, therefore, a seething ferment of virtual particles. A vacuum is not inert **and** featureless, but alive with throbbing energy and **vitality**. A 'real' particle such as an electron must always be viewed against this background of frenetic activity. When an electron moves through space, it is actually swimming in a sea of ghost particles of all varieties - virtual leptons, quarks, and messengers, entangled in a complex melee. The presence of the electron will distort this irreducible vacuum activity, and the distortion in turn reacts back on the electron. Even at rest, an electron is **not** at rest: it is being continually assaulted by all manner of other particles from the vacuum."* [Paul Davies] {699}

*"I assert... that for the general theory of relativity, i.e., in **the** case of the general invariance of the Hamiltonian function, energy equations... corresponding to the energy equations in orthogonally invariant theories do not exist **at all**. I could even take this circumstance as the characteristic feature of the theory of general relativity."* [D. Hilbert] {700}

*"**In formulating the** equivalence principle, Einstein actually abandoned the idea of the gravitational field as a*

*Faraday-Maxwell field, and this is reflected in the pseudotensorial characterization of the gravitational field that he introduced. Hilbert was the first to draw attention to the consequences of this. ... Unfortunately, ... Hilbert was evidently not understood by his contemporaries, since neither Einstein himself nor other physicists recognized the fact that in general relativity conservation laws for energy, momentum, and angular momentum are in principle impossible. " [Logunov and Loskutov] {701}*

*"No amount of theory can refute a replicable experiment that contradicts the theory. A single replicable experiment can refute any theory that is in conflict. That is the very heart of the scientific method. " [Myron Evans, private correspondence].*

*"It only takes a single white crow to prove that not all crows are black. " [Anon.]*

*"One of the most important principles of physics, that disorder, or entropy, always increases, has been shown to be untrue. " [BBC News] {702}*

*"One of the most fundamental rules of physics, the second law of thermodynamics, has for the first time been shown not to hold for microscopic systems. ... [The experimenters]... found that the change in entropy was negative over time intervals of a few tenths of a second, revealing nature running in reverse. ... But over time intervals of more than two seconds, on overall positive entropy change was measured and normality restored." [Chalmers] {703}.*

*"We experimentally demonstrate the fluctuation theorem, which predicts appreciable and measurable violations of the second law of thermodynamics for small systems over short time scales... Our results show entropy consumption can occur over colloidal length and time scales. " [Wang et al.] {704}.*

## A.1 Introduction

For excellent background books on thermodynamics matters, at various levels of difficulty, the reader is referred to texts by Gyftopoulos and

Beretta {705}, Kondepudi and Prigogine {706}, Chalidze {707}, and Dugdale {708}.

It has long been known in physics that at sufficiently small levels (e.g., atomic levels) the second law of thermodynamics does not always hold true. Recently, as quoted above, Wang et al. {704} have extended this area of permissible violation of the second law to much more appreciable times (a few tenths of a second) and lengths (the micron scale). Without further discussion, we note that this places regions and times of negentropy well-withincircuitry switching times and interaction with fundamental chargedparticles. Hence these experiments are beginning to point the way to practical negentropic devices. When coupled with the demonstrated continous giant negentropy of a charge (considered with its clustering virtual charges of opposite signs), these experiments now strongly support the feasibility of practical overunity EM circuits and systems. The interested readerisencouragedtocontinuetoreadtheliteraturealong those lines, and stay abreast of developments in that field.

In this book we have presented considerable discussion of time-energy (time as a special, highly compacted form of energy). We have also discussed the three components of the supersystem, including the system, the local active vacuum, and the local curvatures of spacetime. All three componets of the supersystem interact with each other continuously, and such Interactions are not modeled in classical thermodynamics (CTD), classical electrodynamics (CED), or electrical engineering (EE). Hence one should not be surprised that the supersystem model and supersystem analysis involve contradictions (actually, *extensions*) of these three models, which are special cases and approximations only.

All COP>1.0 EM systems result from supersystem component interactions.

So COP>1.0 EM systems are in conflict with CTD, CED, and EE since these three models exclude those interactions.

To falsify any absoluteness of the three models considered, one or more solid, demonstrable, replicable experiments are presented to establish validity of the new higher symmetry approach. This is sufficient to negate the conventionally accepted absoluteness of the lower symmetry CTD, CED, and EE models. Scientifically, these experiments suffice to demonstrate that those three models describe "*special-case* domains of nature" rather than full generalizations of nature. It is clearly understood that the three models remain very useful and very often quite sufficient, just as Newtonian mechanics is useful and often sufficient, without use of relativistic mechanics.

The experiments also falsify any interpretation of the three models as "proof that  $COP > 1.0$  systems are impossible. Accordingly, many of the accepted statements and assumptions of the three models must be corrected for  $COP > 1.0$  research, as must be the conventional interpretation that the laws of nature (as understood based on those three models) prohibit  $COP > 1.0$  EM systems. This follows directly from the quotation by Evans at the beginning of this appendix. Experimental evidence of  $COP > 1.0$  is abundant and decisive, such as the many hundreds of routine "negative resonance absorption of the medium" experiments as typified by Bohren's paper {709} and experiment and Letokhov's work {710}. Also, every charge in the universe already falsifies all three models, as amply discussed in this book. That fact for at least a century has generated the source charge problem — the problem of the source charge and its associated fields and potentials and their energy, reaching across the universe. The solution to this problem was published by the present author in 2000, based on the experimentally proven and well-established broken symmetry of opposite charges, such as are on the ends of a dipole.

In the extended approach, conservation of energy in 4-space does not require simultaneous conservation of energy in 3-space. The concept of energy conservation in 4-space does not exist in the three models mentioned, which contain only 3-space energy conservation. There exists a "giant negentropy" 4-space energy flow (circulation) mechanism, as we developed in this book, and it is experimentally demonstrated by every charge in the universe. In a classical 3-spatial energy conservation analysis and view, the giant negentropy action may continuously perform useful work in a system, since it already furnishes all EM field energy and potential energy in every system. All 3-space energy conservation is an extra condition imposed upon 4-space energy conservation, and that condition may be violated at will without violation of the general conservation of energy law.

To the three conventional models mentioned, 4-symmetry in energy flow with broken 3-symmetry, will appear to be perpetual motion and a total violation of the more limited 3-space conservation of energy law. It *does* permissibly violate 3-space energy conservation, which is just a special case a priori. But it is not a violation of energy conservation overall, since we are using a more fundamental energy conservation law (4-symmetry) than the 3-symmetry used in the mentioned CTD, CED, and EE models,

In short, the three models must be extended to provide 4-space energy conservation with simultaneous violation of 3-space energy conservation, accompanied by simultaneous time-symmetry energy flow violation. The

two broken symmetries — of 3-space energy flow and of time domain energy flow — thus act as a special extension of the notion of symmetrical regauging, accomplishing it by "equal and opposite-effecting" fields, one in the time domain and one in 3-space.

Ironically it then follows that what have heretofore been conceptually called "perpetual motion machines" with respect to 3-space energy conservation are simply attempts — successful or unsuccessful — to build analogues of a windmill turning in a free wind and powering a load. In short they are attempts to duplicate in systems what every charge in the universe already demonstrates unequivocally. *Nature's* CTD, CED, and EE do not prohibit such systems — again, as evidenced by every charge in the universe demonstrating exactly such "perpetual motion" (we prefer the exact term "giant negentropy") and violation of present *human* CTD, CED, and EE. None of the original charges from the beginning of the universe has slowed and stopped its motion, or stopped pouring out EM energy freely, in some 14 billion years or so. And charge may be taken as the most basic Maxwellian system. Further, all EM fields and potentials, and their energy, comes from their source charges. So those so adamant against perpetual motion machines should first purge their own three models of their *assumed* perpetual motion machines. If this is done, they will purge the three models of all charges, fields, and potentials — and all EM energy in the process. In short, the three conventional models used by those same skeptics so loudly condemning "perpetual motion machines" will eat themselves" by swallowing their own tail, so to speak.

in short, all three models are easily falsified by every charge in the universe, as well as by every EM field and potential, and by the existence of EM energy itself.

Either their models must surrender any pretense at absoluteness and accept being useful approximations only, or else the conservation of energy law itself must be surrendered.

**Conventional** CEM, CTD, and EE have just hidden this appalling fact and conveyed the serious flaws in the modeling by ignoring what Sen {711} referred to as " *the most difficult problem in classical and quantum electrodynamics*. "We believe it will very difficult to find a single electrical engineering department or professor or text that deliberately acquaints electrical engineering students with the source charge problem and its implications.

As an example, in Chapter 9 we presented an experimentally verified and patent-pending method for a special energy conversion method. This

method is proven on the laboratory bench. With this method, a system accepts time-energy and negative energy input, converts it to ordinary positive 3-spatial energy, and uses the converted input energy to close-loop an EM system far from equilibrium. With that conversion process invoked in a governed feedback loop, the  $COP > 1.0$  system becomes "self-powering" (an informal term referring to the system freely receiving all its input energy from its active environment). Self-powering, of course, involves the system continuously operating and performing useful work, analogous to a windmill in a wind and powering a water pump. Rigorously, the self-powering  $COP = \infty$  EM system becomes directly powered by energy from the broken symmetry induced in its supersystem component interactions.

In Chapter 10 we presented the novel concept of the time-reversal zone (TRZ), which uses the extraordinary EM energy density of time to reverse the Coulomb barrier in nuclear reactions in an electrolyte {712}. This enables nuclear transmutation reactions at low *spatial* energy (but at very high *total* energy when time energy is also considered). There are some 600 successful cold fusion experiments worldwide, in multiple laboratories, by multiple researchers, and most of these experiments demonstrate examples of the specific nuclear reactions made possible by the actions of the TRZ. The time-energy anomalies are directly demonstrated in rigorous electrolyte experiments at U.S. Navy research facilities at China Lake, as we have also discussed in this book. So the experimental results are replicated and well proven. Hence there is adequate, replicated experimental demonstration that additional nuclear reactions exist outside the conventionally known nuclear reaction model. Therefore the set of conventional nuclear reaction models also is reduced to a special case domain, with any absoluteness of those models already experimentally falsified. Either that, or we must abandon scientific model where successfully replicated experiments falsify any theory in contradiction to the experiments.

In our proposed solution to the source charge problem {71 lb}, we found a broken 3-symmetry in energy flow while 4-symmetry is maintained. This is a more primary principle of energy conservation. We called this principle "giant negentropy", which is laughably simple to demonstrate experimentally, since every charge and dipole in the universe already demonstrates it. We showed that such giant negentropy is consistent with quantum field theory, particle physics, and a slight corrective reinterpretation of Whittaker's 1903 decomposition of the scalar **potential**. The experimentally proven and theoretically justified giant negentropy

falsifies any absoluteness of the CTD, CED, and EE models in conflict with it.

Again, this does not mean that one abandons the CTD, CED, and EE models! They are still very useful models in most cases of interest. It means that these present models are still incomplete, and extended models must be developed and used for  $COP > 1.0$  EM system research. It also means that none of these three models is valid as a prohibition of the permissibility of  $COP > 1$  EM systems.

All EM energy in 3-space comes from the time domain and returns to it. Since all three models exclude time-energy and its transduction into spatial energy, all three are in conflict with the proven giant negentropy model and with the unlimited experimental demonstrations. Accordingly, the experimentally demonstrable giant negentropy of the charge and dipole strongly points out the inadequacy of the three models and the nuclear reaction models, which do not account for time reversal zones, or time-energy and its transduction into a very large magnitude of 3-space energy.

In paragraph A.2 below, we briefly discuss some of the fundamental but permissible supersystem violations of these older models of CTD, CED, and EE, and provide some comments. It is obvious that all three classical models need very serious updating and extension. We point out that exceptions to present thermodynamics models and "laws" already are recognized {713}, and work on such exceptions is being performed under the heading of extended thermodynamics {714}.

In effect, all three models *exclude* every charge, dipole, or dipolarity in the universe - which therefore excludes all matter, fields, and energy - something completely untenable in modern electrodynamics and modern physics. Since the fundamental nature of the "heat" notion of CTD is electromagnetic field energy, and all EM fields and potentials (and their energy) are excluded if their source charges are excluded, then heat itself is excluded by the three models. That is, CTD is also totally falsified by CED'S exclusion of the source charge's demonstrated giant negentropy, which in effect excludes heat itself. This is a non sequitur of such magnitude that it absolutely requires the complete rework of CTD, CED, and EE.

#### A.1.1 Features of the Development of Thermodynamics

In the development of thermodynamics, a few key events of interest are listed in Figure A-1 below.

Selected Events in the History of Thermodynamics {715}

- 1673 Huygens builds a motor driven by gunpowder explosion.
- 1690 Papin uses steam to move a piston.
- 1712 Newcomen develops a steam engine.
- 1723 Stahl popularizes phlogiston and Becher's concepts.
- 1724 Boerhaave proposes that heat is a fluid.
- 1733 Bernoulli publishes a text that is the first truly statistical treatment of kinetic theory, and publishes an update in 1738. It is almost forgotten until 1859.
- 1765 Watts invents a steam engine that is more than six times more effective than Newcomen's engine.
- 1783 Lavoisier points out the weakness of phlogiston theory with respect to combustion.
- 1786 Lavoisier and Laplace provide a Memoir on Heat.
- 1789 Lavoisier publishes his *Elementary Treatise on Chemistry*, which presents the law of conservation of mass.
- 1791 Prevost publishes a theory of heat and radiation exchange. Richter founds stoichiometry.
- 1798 Thompson demonstrates the conversion of work into heat, in his *Enquiry Concerning the Source of Heat which is Excited by Friction*.
- 1799 Davy's experiments seriously challenge phlogiston theory.
- 1800 Herschel explores the heating ability of different frequencies of light.
- 1802 Lussac establishes the thermal expansion of gases.
- 1803 Dalton forms his atomic theory of matter, setting the stage for atomic chemistry.
- 1804 Leslie shows that light and radiated heat have similar properties.
- 1806 Young formulates a precursor to the modern kinetic energy.
- 1811 Poisson develops a mathematical theory of heat, based on Fourier's work. Avogadro presents his law. Berzelius states that electrical and chemical



- forces are the same and that atoms are electrically charged.
- 1819 Dulong and Petit show an empirical law on the specific heat of solids.
- 1824 Carnot studies the thermal efficiency of machines, introduces reversible transformations, and generates the foundations of thermodynamics in his "Reflections on the Motive Power of Fire".
- 1829 Coriolis defines "kinetic energy".
- 1834 Clapeyron presents the first version of the second law of thermodynamics, based on steam engine studies.
- 1837 von Suerman experimentally verifies Clapeyron's version of Carnot's equations.
- 1842 Mayer equates the conservation of energy law and shows the equivalence between heat and mechanical energy.
- 1843 Waterston anonymously publishes an accurate kinetic theory of gases. It is essentially ignored.
- 1845 Waterston submits a beautiful paper on the kinetic theory of gases to the Royal Society. It is rejected and ignored for more than 40 years, until finally resurrected by the President of the Royal Society.
- 1847 Helmholtz generalizes the conservation of energy law for mechanical, caloric, electric and magnetic energy.
- 1848 Lord Kelvin introduces the absolute temperature scale. Joule finishes establishing the exact relation between heat and mechanical work; his work is almost ignored.
- 1850 Clausius states the second law of thermodynamics.
- 1851 Thomson derives the second law of thermodynamics based on Carnot's work.
- 1855 Rankine publishes *Outlines of the Science of Energetics*.
- 1857 Clausius establishes heat as energy distributed among particles.
- 1858 Clausius introduces the idea of the mean free path of a colliding particle.

- 1859 Kirchoff establishes the thermodynamic foundation of radiation theory, and completes the basic radiation theory in 1862.
- 1860 Maxwell provides studies in kinetic theory of gases and gives the distribution of molecular velocities. The paper, "Illustrations of the Dynamical Theory of Gases," was read in 1859.
- 1860 Maxwell shows a discrepancy between experiment and the kinetic theory of diatomic gases. It was not resolved until the early stages of quantum theory.
- 1861 Kirchoff advances the notion of the blackbody.
- 1865 Clausius, Rankine and Kelvin provide the concept and definition of entropy.
- 1860-1877 Boltzmann and Gibbs provide the foundations of statistical classical mechanics.
- 1867 Maxwell publishes *On the Dynamical Theory of Gases*, his major work on the kinetic theory.
- 1874 Thomson points out the reversibility paradox.
- 1877 Boltzmann defines entropy in terms of probabilities.
- 1873-1878 Gibbs publishes several important papers on thermodynamics, widely influencing scientists.
- 1879 Boltzmann establishes the relation between radiation intensity per unit area of a blackbody, and the absolute temperature. Stephan formulates the "Stephan-Boltzmann law"  $R_T = \sigma T^4$ .
- 1879-1899 Discoveries of various laws and effects, particularly at the micro level.
- 1900 Planck proposes the quantum of action and derives the correct radiation spectrum for blackbodies. (He published the definitive paper in 1911).
- 1905 von Smoluchowski and Einstein independently investigate Brownian motion. Einstein publishes a paper on the photoelectric effect.
- 1906 Nernst advances his heat theorem, where at absolute zero temperature both heat capacity and entropy change go to zero. This is later recognized as the "third law of thermodynamics".
- 1909 Einstein corrects Planck's blackbody derivation.

- 1910 Perrin experimentally validates Einstein's calculations on Brownian motion, providing a strong argument for the existence of atoms.
- 1911 Rutherford proposes the nuclear model of the atom. Sackur points out the need for an absolute definition of entropy. Nernst's experiments provide strong support for the new quantum theories.
- 1925 Born, Heisenberg and Jordan formulate quantum mechanics from matrix algebra. Einstein points out that the analogy between quantum gases and molecular gases is complete; photons and molecules have both wave and particle characteristics.

Figure A-1. Key Events in the History of Thermodynamics up to the Development of Quantum Mechanics.

During the early period of science, a continuing struggle between various notions of esoteric fluids and fluid flow occurred. French scientist Lavoisier (1743-1794), regarded as the father of chemistry, is identified with the concept of heat as an invisible fluid, which he named "caloric". The notion was that one drove this invisible fluid — this caloric — out of a material by some action such as mechanical friction or combustion. This produced the "manifestations" of what was loosely called "heat". In short, caloric was considered to be "heat" which was itself an esoteric fluid. In his famous Treatise {716}, published posthumously, atoms were still in dispute. However, Lavoisier listed the known elements, and included light and heat as elements. Asimov pointed out {717} that Lavoisier had *"... eradicated one imponderable fluid, phlogiston, but it was only partly through his influence that caloric, just as false, remained in existence in the minds of chemists for a half a century."* Caloric dogmatically existed in the minds of scientists deeply into the nineteenth century, until Maxwell and Boltzmann produced theories that strongly supported the concept of atoms as the building blocks of matter. In the late 1790's, Count Rumford (Benjamin Thomson) showed that the supply of heat that could be "driven from matter" was unlimited, which totally contradicted the caloric theory {718}. Yet the notion of caloric persisted until Maxwell's theory eventually killed it, once application of that theory showed that heat was comprised of EM energy.

The fundamental ansatz of thermodynamics was formed and solidified before the advent of modern physics, and even before Maxwell's theory of electrodynamics, and before heat was known to be electromagnetic energy. It has unjustifiably retained an aura of "absoluteness" and dogma, even though its foundations concepts are based on outdated notions already scientifically falsified as far as any absoluteness is concerned. As Mallove states {719}:

*"It is astonishing to realize that many modern conceptions (or laws') in the science of heat— thermodynamics — arose during the nineteenth century, a period of utter confusion about the fundamental nature of heat. How could it have been otherwise, given that the very existence of atoms was still in question! One sees the shakiness of the claim that the laws of thermodynamics had reached a state of near perfection' in the twentieth century ...when they in fact rested on this very flawed foundation. "*

During that formative period, the notion of the conservation of energy **was** also being searched for, as if in a thicket of brambles. For some time, any notion of energy conservation was seen as directly contradicted by caloric, and — in formulating the heretical notion that energy is conserved — pioneers such as Mayer {720} were severely castigated.

In 1850 Clausius resolved the conflict between caloric and conservation of energy in a seminal paper {721}.

Mallove {722} explains how the theory developed from there:

*"In one fell swoop Clausius 'scooped' Kelvin and cast into precise form both the First and Second Laws of Thermodynamics — energy conservation, and the limit of the Carnot efficiency."*

Clausius' statement of the Second Law is: *"It is impossible for a self-acting machine, unaided by an external agency, to convey heat from one body to another at a higher temperature. "*

In 1851, Thomson (Lord Kelvin) stated the Second Law as:

*"It is impossible, by means of inanimate material agency, to derive mechanical effect from any portion of matter by cooling it below the temperature of the coldest of the surrounding objects."*

In 1865 — the same year that Maxwell published his seminal paper in his electrodynamics {723} — Clausius derived entropy and showed the two laws of thermodynamics expressed in the same way as the old caloric theory. Clausius used the concept of "entropy" to represent the "*dissipated potential*". In a public speech with the title "The Entropy of the Universe Tends to a Maximum," Clausius included how thermodynamics requires an eventual heat death for the universe. His view was that

*"The energy of the universe remains constant (first law), while entropy increases. "* {724}

We stress that the notion of the flow of EM energy through space did not originate until the 1880s, when Heaviside and Poynting formulated it independently. Neither relativity — with its notion of a combined spacetime - nor the Minkowski space had been born. Neither had quantum mechanics, quantum electrodynamics, quantum field theory, etc.

For a succinct and very useful listing of the major developments in the history of thermodynamics and statistical mechanics, one is referred to the work of Biggus {725}.

#### A.1.2 Inadequate Fundamental Definitions in Thermodynamics

In the view we take in this book, energy is the all-important concept, in all its forms, no matter how esoteric. The interactions of energy with matter must therefore be extended to include all known energy interactions, not just those prescribed by CTD or CED. Consequently, two fundamental definitions of thermodynamics are faulted by the supersystem concept.

First, thermodynamics defines an *open system* as one that is open to the exchange of energy and mass across its boundary. No concept or discussion of virtual energy, virtual mass, time-energy, or multiply connected space effects is included. Further, mass is actually a special form of energy, and hence this definition only prescribes the exchange of energy across the system boundary.

Second, thermodynamics defines a *closed system* as a system with no mass exchange across its boundaries, but heat (energy) exchange is permitted. This definition has been a non sequitur since general relativity was established in 1915, and also since caloric (heat) was identified as energy rather than a thin material fluid that was forced or beaten out of matter by doing work on the matter. Since then, energy and mass are also known to be the same thing, as established by general relativity. Whenever the energy of a system changes, its mass changes a priori. So a system thought of as "closed to any mass transfer across its boundaries" still undergoes

mass change due to the exchange of energy across its boundary. Further, the definitions of "closed system" and "open system" are not mutually exclusive. As an example, a system exchanging energy but not mass across its boundary can be classified as a "closed system", and also as an "open system" where normal exchange of mass is blocked but the mass of the system still changes as the systems absorbs and emits energy.

Rigorously, even the energy of a system cannot individually change in 3-space, without first invoking 4-space change! Instead, the "energy x time" — the action — of the system is what moves and changes in 4-space. Observation applies a  $d/dt$  operator, resulting in a 3-space energy observed as having already happened or been fixed.

The modern view of gravitation is that the energy in mass generates the gravitational field, not the mass per se {726}. Also, mass is an observable, hence it is a continuously recurring 3-spatial snapshot that does not even continuously exist as mass, but alternately as mass and masstime. The assumption of the continuous existence in mass is falsified by the quantum mechanical nature of observation itself; hence all three models — CTD, CEM, and EE — are falsified.

Nonetheless, let us continue to use the conventional notion of "flow of energy" and "flow of mass" for convenience.

The thermodynamic definition of "open system" ignores the state in which mass exists as "masstime". No "change of mass", flow of mass, etc. occurs. Instead, masstime can flow or change, but mass is an observable and **thus** frozen 3-space snapshot at one instant. Time is "outside" any 3-space material system, hence when mass becomes masstime, it already "exchanges across the system boundary". *For a mass merely to continue to exist requires the exchange of mass across the 3-space system boundary.* Indeed, only "masstime" can be changing, so in failing to consider masstime, the definition is falsified as it stands, in its very assumption of "continuous change of mass" when there is no such thing in all of nature. As stated, a similar consideration applies to energy, which does not **and** cannot "continuously exist in 3-space" at **all**, and cannot *continuously* change. Also, *time is highly concentrated energy* as we develop in this book, and time certainly "exchanges across the boundary" of any mass system. Time may be taken as a sort of "multiple connection" in space, since in theory each point in space is said to "exist simultaneously" in the same time-point.

With quantum potential connection, external energetic processes may be "superposed instantly in multiply-connected space" with one or more

points of the "closed system". Hence, if there exist processes in the system to transduce time-energy into 3-spatial energy — as in the well-proven cold fusion experiments — matter changes including nuclear transmutations can and do occur. Then the "system closed against mass motional exchange through 3-space" (which does not even concretely exist) is not closed against mass changes at all.

To eliminate the mass-change effects of energy transfer across the system boundary, the present thermodynamic definition of a *closed system* must be completely recast into what thermodynamics presently calls an *isolated system* - one in which neither energy nor mass is exchanged across the system boundary. No such system exists in the universe, since merely to exist it has to be open to continual energy exchange between time and 3-space domains, mass has to continually interchange between mass and masstime, and energy has to continually interchange between energy and (energy x time). The blunt truth is that *only open systems exist in nature*.

All systems are open systems in their supersystem interactions, and they can and do exchange time-energy and mass changes due to spacetime curvatures and active vacuum changes. Any local spacetime curvature made by an energy change in a system or nearby, also reacts back upon the system from its local curved spacetime environment. It may react in a totally energetic fashion, or it may react to produce mass in the system (as in pair production). In the book we pointed out that the supersystem components external to the system can also interact in the system to eliminate mass (as when a Dirac hole combines nonradiatively with a Dirac **electron**).

Finally, the notion of an "open system" as one in which energy and mass both can be exchanged across the system boundary must be extended to include a system which can also exchange time-energy, spacetime curvature energy, virtual particle flux activity and energy, and other supersystem effects across the boundary. Further, the notion that a "closed system" can be open to energy exchange but not mass is totally falsified in modern physics' virtual particle exchange between environment and system. Virtual mass — which is physically real — is continually exchanged across the system boundary. Though each virtual mass particle is individually unobservable, coherent summations are observable.

To properly evaluate the conventional thermodynamic definitions of open system, closed system, and isolated system, simply select and use a physics model containing only one fundamental unit, the joule. Now all basic entities are made of energy and functions of energy. So all basic

entities are forms of energy; e.g., both mass and time are special forms of energy. As presented previously in this book, to even "exist in time" a system is continually exchanging and transducing 3-space energy and time energy, across its boundary at an enormous rate. Every system is an open system, a priori, and the thermodynamic "closed system" is a non sequitur. The thermodynamic "isolated system" is revealed as the early attempts to deal with observation; i.e., the observed system as a series of frozen 3-space snapshots (effects), each stripped from a 4-space ongoing process at a single moment by the observation process  $d/dt$  (LLLT) = LLL. Each snapshot is an isolated system (which is what observation produces). Now we understand that this "isolated system" existed only at a single frozen instant, continually recurring, and never existed continuously in time at all,

So in view of today's physics, the old thermodynamic "isolated system" concept is an early attempt to deal with observation of the system without input or output (without dynamics, hence frozen). "Closed system" is a non sequitur since mass is energy and energy is continuously exchanged across the system 3-boundary in several forms. Both virtual mass and virtual energy are continuously exchanged across the system boundary. It follows that the only type of system existing continuously in nature is the *open system*. The other two "types of thermodynamic systems" are at best only approximations for special cases.

Under modern physics and the new definitions, we conclude that there is no such thing as a truly closed or isolated system continuously existing in the universe. Hence that very definition disappears, *as far as any absoluteness*. It is retained only as a *useful approximation in special cases*, when the more esoteric mass effects and energy effects are intentionally omitted or negligible, and only classical effects are of importance. Any scientist dogmatically objecting to COP>1.0 EM systems on thermodynamics grounds alone, simply reveals his lack of knowledge (or lack of acceptance) of modern physics.

This is similar to the situation existing between Newtonian mechanics and relativistic mechanics. We can still use the Newtonian model for many practical matters, since the relativistic effects are often small and nearly inconsequential. Similarly, the present CTD concept of "closed system" now assumes that kind of relationship to *one class* of open systems in which the more esoteric reactions are negligible or inconsequential. But rigorously, all systems are now open systems, removing a gross non sequitur in CTD which is especially violated by COP>1.0 EM systems including every charge in the universe.



This is a correction to both equilibrium (classical) thermodynamics and disequilibrium thermodynamics. Unfortunately the two disciplines have continued to use the same (old) definitions for closed system and open system. Hence both equilibrium and disequilibrium thermodynamics at present are useful approximations, and their "laws" must not be misinterpreted as "absolute". Thermodynamics remains a very useful model, but further development is also indicated. Indeed, presently such scientific development and extension of the thermodynamic model is being done under the heading of "extended thermodynamics".

## A.2 Comments on Problems with Thermodynamics

Quoting, from Kondepudi and Prigogine {727}:

*"Every system is associated with an energy and an entropy. When matter undergoes transformation from one state to another, the total energy remains unchanged or is conserved; the total entropy, however, can only increase or, in idealized cases, remain unchanged. "*

The absoluteness of that statement is falsified by the solution {12} of the long-vexing problem in CED of a source charge and its associated fields and potentials. The observable charge is a charged mass and thus a Maxwellian system. It is also a thermodynamic system, meeting the present erroneous definition of a "closed system" utilized in both equilibrium and disequilibrium thermodynamics. No observable mass crossed the system boundary, although virtual mass continually crosses it.

The charge is "fed" by a more esoteric energy input in disordered form (the virtual particle flux energy of vacuum), yet it outputs ordered observable EM energy spreading radially outward at the speed of light across the universe. The charge increases and sustains the organized energy density of a volume of space depending on the radius  $ct$ , where  $t$  is the time since the formation of the charge and  $c$  is the speed of light in empty space. This continuous outflow of observable energy is a continuous and giant negentropy, exhibited by every source charge and dipole. When positive charge, negative charge, polarization of space, and both positive and negative energy are considered, what is spreading is precisely a reordering of the active vacuum — in short, a giant and increasing negentropy. Since the universe is filled with charges, this is a natural process continuously ongoing everywhere in the universe.

Re-quoting Serway(697):

*\The second law [ofthermodynamics] does not rule out the possibility of pushing heat uphill, as it were, from a cold object to a hot one, or ofcreating order out of disorder. It merely states that such a reversal ofthe naturalflow requires an influx ofenergy... "*

Our comment is that any mechanism by which the system receives extra usable energy in forward time, or is time-reversed, enables the system to permissibly violate any narrow interpretation of the second law of thermodynamics. The second law was formulated in accord with forward time assumed, and with the old definition of "closed system", which erroneously permitted energy exchange but ignored the mass effects of energy exchange. Therefore, the second law is a special case for equilibrium in its energy exchange with its active environment, but effectively allowing its own negation anyway, and it always has. In the new approach with altered definitions, all EM systems are open systems, and they may also be brought into disequilibrium (in excited states or potentialized condition). Thus in theory all systems are permitted to violate the second law, *particularly when broken symmetries in their supersystems are involved*. This is especially true of EM systems, where all the EM field energy and potential energy in the system— even in the matter itself— comes from the active vacuum environment (particle physics view) by means of the broken 3-symmetry of the source charges and dipoles. The condition of 4-symmetry in energy flow exchange together with broken 3-symmetry and t-flow symmetry, is a disequilibrium condition and an excited state. Every charge and dipole already exhibits this state and the giant negentropy condition.

To first order, then, one may say that the present second law assumes no broken 3-symmetry or broken t-flow symmetry in energy flow, while violation of the second law assumes broken 3-symmetry and broken t-flow symmetry.

Quoting Serway {728}:

*"Thermal equilibrium is a situation in which two objects in thermal contact with each other cease to have any net energy exchange due to a difference in their temperatures."*

Our comment is that net energy exchange — to include time-energy exchange and negative energy emission, absorption, and transduction are not modeled in thermodynamics and are arbitrarily excluded in **the** quoted statement. Since both are exhibited experimentally, the statement is

falsified as far as being absolute. Instead, it is a special case and a useful approximation when some of the esoteric energy considerations are negligible.

Quoting Serway again {729} on the zeroth law of thermodynamics:

*"If objects A and B are separately in thermal equilibrium with a third object, then A and B are in thermal equilibrium with each other. "*

A corollary is stated by Serway {730} as:

*"...two objects in thermodynamic equilibrium with each other are at the same temperature. "*

Our comment is that these statements are true if the time-energy exchange is identical among all three. Otherwise, they are not necessarily true. It is not generally true, e.g., for a system in an accelerated frame. Also, the zeroth law is not necessarily true if negative energy (and/or its transduction is involved with one or more of the objects.

An example: A and B are at the same temperature as C, as measured by a thermometer. But A is also emitting negative energy, which is being absorbed by B, to maintain A and B at the temperature of C. A and B are not in real thermal equilibrium in their supersystem interactions, even though they are at the same macroscopic temperature. A second example: A is emitting negative energy to maintain its temperature, while B and C are not. The supersystem of A is not in real thermal equilibrium with the supersystem of either B or C, even though the observed temperatures of A, B and C are the same.

Quoting {731} on what is meant by the term "heat":

*"...heat is treated as another form of energy that can be transformed into mechanical energy. " ... "The word heat should be used only when describing energy transferred from one place to another. That is, heat flow is an energy transfer that takes place as a consequence of temperature difference only."*

Quoting Lindsay and Margenau {732}:

*"A complete statement of the first law comprises two **assertions**: (a) heat is a form of energy, (b) Energy is **conserved**."*

The statement in (a) that heat is simply a form of energy is misleading, and the statement in (b) that energy is conserved must be expanded to include total energy, not just heat and the presently accounted forms of energy. Specifically virtual particle energy, time-energy, and energy from the curvature of spacetime must be included.

More correctly, heating is a form of *energy disordering* or energy scattering. As previously pointed out, entropy itself was and is conceived as *the dissipation (irretrievable loss) of potential energy*. Heat thus would be the process of energy disordering, which means that heat is a form of the process of entropy (loss of control of the energy). Note the strong non sequitur with the notion that heat is energy. *Heat cannot logically be both energy and the dissipation of energy*. The concept of energy (its mere presence) is not identical to the concept of scattering of energy or transfer of energy, but the concept of heat is identical to it. The thing is not identical to something done to the thing or to transfer of the thing to another place. A form of scattering of order is not a form of ordering. Transfer of heat is a transfer of disordering of energy, not the transfer of energy per se. Hence, considering heat as simply "heat energy" is a fundamental non sequitur of classical thermodynamics, and remains so to the present day and in the present textbooks. For an example of strong support of this position, see Romer {733}. Quoting {734}:

*"The work done on (or by) a system is a measure of energy transfer between the system and its surroundings, whereas the mechanical energy (kinetic or potential) is a consequence of the motion and coordinates of the system. Thus, when you do work on a system, energy is transferred from you to the system. ... one can refer only to the work done on or by a system when some process has occurred in which the system has changed in some way."*

Our comment: Consider a system which "ping-pongs" the energy it receives from the environment, between two parts of itself. In each part, the form of the energy is changed by that interacting part and that does work upon the part. But the new form of energy remaining after the work was done in that component is not lost but is ping-ponged to the other component, where it does work upon that component, and so on. In this case, each joule of energy input from the environment does more than a single joule of work, with the work performed being limited only by the ability of the system to sustain and contain the "ping-ponging". There is

work but no entropy if the energy doing the work (changing its form) is not lost from system control!

There is no law of "work conservation" in nature, and a joule of input energy can do more than one joule of work (as in this example) if repetitive changes of its form are considered. Thermodynamics arbitrarily excludes such cases, and hence is incomplete. Again, the conventional perception of the absoluteness of thermodynamics is falsified. It models a special case where the energy can be "used" to do work only once, and then all control of the new form of the energy (it is all still there, just in a different form) is lost.

For a particular substance, the heat capacity  $C$  is usually defined as *the amount of heat energy needed to raise the temperature of the sample being tested by one degree Celsius*. This definition assumes only one "use" of the energy to perform work in the substance, and completely ignores "multipass, multi-use" of the energy to perform more than one joule of work from one joule of input energy. As an example, if an equal amount of positive and negative energy is steadily input, then no amount of the positive heat energy input component would raise the temperature at all. The modern active vacuum, with a local energy density in the region of  $10^{80}$  or more grams per cubic centimeter (expressed in mass units), nevertheless is harmless to living systems immersed in it. It has equal positive and negative energy densities, and so normally inputs the same enormous amount of positive and negative energy in its overall interactions with a living system.

The first law of thermodynamics is usually written as

$$\Delta U = U_f - U_i = Q - W. \quad [1]$$

This is a highly special case, which does not include time energy transduction (spatial energy transduced into time energy and vice versa), or energy transduced from the active vacuum via the broken symmetry of an electrical system in continuous exchange. The definitions of work and heat have to be changed and drastically extended.

As an example of a legitimate exception, when time-energy  $T_E$  is transduced into available spatial energy inside the system, we have

$$\Delta U = U_f - U_i = Q + T_E - (W_D + W_L) \quad [2]$$

where  $W_D$  is the energy that was dissipated in the system losses without doing useful work and  $W_L$  is the energy leaving the system but doing useful work in a load  $L$ .  $(Q + T_E)$  represents the total net energy entering

the system, while  $(W_D + W_L)$  is the total energy leaving the system, either as losses or to do useful work in the load. Here we are also incorporating virtual energy under the title of time-energy, since both time and virtual energy are unobservable, and virtual energy "exists in time".

Now suppose  $Q$  entering the system, and collected for use in it, is freely furnished from the active vacuum via the broken symmetry of the electrical system's dipolarity. Suppose  $T_E$  is spatial energy freely transduced from the time domain by ongoing processes in the system, and thus  $T_E$  also enters the system freely. Then suppose that the system processes are deliberately adjusted by the operator so that

$$(Q + T_E) = (W_D + W_L) \quad [3]$$

In that case,

$$\Delta U = U_f - U_i = 0 \quad [4]$$

yet continuous loss energy  $W_D$  is escaping from the working system, useful work  $W_L$  is continuously being done in the load, and useful energy  $(Q + T_E)$  is continuously entering the system from the active environment (the active vacuum and the local curvatures of spacetime). This system is totally permissible in nature (and is already operating in every charge and dipole in the universe). It is an example of an open system far from equilibrium in *3-space* energy flow, but in equilibrium in *4-space* energy flow. Yet it is artificially excluded by classical thermodynamics.

*Classical thermodynamics thus excludes every charge and dipole in the universe, and therefore is an extraordinarily curtailed model.* It is a special case approximation having no absolute authority as a proper limiting model of EM systems.

The first law of thermodynamics for infinitesimal changes may be stated as

$$dU = dQ - dW \quad [5]$$

Following the previous reasoning, for involvement of time-energy transduction (with virtual energy included) we have

$$dU = dQ + dT_E - (dW_D + dW_L) \quad [6]$$

If  $dQ$  and  $dT_E$  are freely received in the system from the active vacuum and local curvatures of spacetime respectively, and if

$$dQ + dT_E = dW_D + dW_L \quad [7]$$

then

$$dU = 0 \quad [8]$$

So with no change in its internal energy at all, the microsystem or microprocess is receiving excess energy continuously, and also is continuously emitting energy that is doing useful work with some losses. The system is in fact in *energy 4-flow* equilibrium, and doing useful work, without the operator inputting any of the energy.

So the *corrected* standard statement of the first law allows an equilibrium system to steadily produce output work  $W$ , if its "energy input  $Q$ " is freely received. The first law of thermodynamics, properly extended and reinterpreted, does indeed admit "electrical windmills" operating in free electrical winds.

Now turning to the second law. In effect, the second law prescribes those processed in nature — more exactly, in the prescription of the first law — that may or may not occur. It is a law of limitation. It states that, of all the energy conversion processes permitted by the first law, only certain types of energy conversions can take place. A priori, the validity of its prescription depends totally on the nature of the functions involved in the system considered! However, since we dramatically extended the first law, using new processes experimentally determined to take place, then we have automatically extended and changed the second law because we used experimentally *proven* functions. The old second law is now revealed as a special case, with no absolute limitations. The perception that it prescribes absolute limitations has been falsified. It is still useful, however, but to be careful one must completely re-examine (and possibly rework) the second law whenever the energy functions of a system are changed. We strongly stress that *the second law is a conditional law, and its application is totally dependent upon the system energy functions behaving in the limited manner assumed by the second law. Whenever the energy functions of the system are changed outside those assumed by the second law, the second law is permissibly invalidated for that system.* In short, in that case the second law is simply a totally inadequate model for that system, and cannot be used as any sort of criterion for stating the "permissibility" or "impossibility" of that system. As an analogy, a model specifying scalars only cannot be applied to a vectorial system as a decisive logical criterion or restriction.

Quoting Seray {735}:

*"From an engineering viewpoint, perhaps the most important application [of the second law] is the limited efficiency of heat engines. Simply stated, the second law states that a machine capable of continuously converting*

*thermal energy completely into other forms of energy cannot be constructed."*

Our comment is that, if we believe that energy is conserved in the entire universe, then the universe itself already violates Serway's statement. If we consider the seething virtual particle flux energy of the active vacuum as a special form of thermal energy, then every charge and dipole in the universe already is a heat engine that falsifies the second law of thermodynamics. The charge and dipole continuously absorb this special form of thermal (virtual flux) photon energy, and also continuously convert it into real, observable photon emission in 3-space. This is negentropy on a giant scale, already demonstrated by every charge and dipole and thus experimentally falsifying the present second law.

Classical thermodynamics also assumes irreversibility. While many of the physics models and equations prescribe reversible reactions, thermodynamics takes the view that events occur with a much greater probability in one direction in time than in the other. This of course is usually borne out in our perception of the gross observable universe around us. However, charge conservation alone requires equal amounts of charge and time-reversed charge. With the nearly ubiquitous time-reversed charge and charge conservation, it follows that some factor not accounted for in thermodynamics is operating in the universe. And so it is, but it is a general relativistic factor. We shall use a biological example of the cellular healing mechanism we discovered in the living body {736}, extending Becker's work and Priore's work.

Normally most processes do not involve deliberate net transduction of time-energy into spatial energy, nor do we model and account for the specific set of ongoing interactions between every part of the system **and** its concomitant set of spacetime curvatures acting back upon it. Call that set of spacetime curvatures the *resident spacetime curvature engine and its dynamics*, or just *its engine* for short. The engine is comprised of structured energy and energetics, and it is already experimentally demonstrated in nonlinear phase conjugate optics that energy can be **time** reversed. The engine's spacetime curvatures act directly upon the **mass-**energy dynamics of the system. Time-reversing the system's operation is a matter of producing a sufficiently amplified, phase conjugated engine to act in reverse upon the physical system and overpower its resident **engine**. In that case, the thermodynamic system and its functioning can be **made to** run backward.



In fact this is the fundamental mechanism used by the body's own cellular regenerative system to heal its damaged cells. To a limited degree, the body is able to "pump" its cells in the time-domain (with time-energy), thus producing an amplified "phase conjugate energy and engine dynamics".

Pumping a living cell with time-energy is interesting. The resident engine serves as the "signal input wave" in conventional nonlinear phase conjugate optics, and the output time-reversed engine (the amplified anti-engine) serves as the "phase conjugate replica wave". A sufficiently simplified anti-engine acts upon the cell and all its tiniest parts, time-reversing all energetic operations in exact phase, proportion, and timing. This is the mechanism for thermodynamic reversibility. It is also the "secret" to eventually reversing aging.

This action is upon all the energetics of the cell and its parts, including the mass-energy and mass-energetics as well.

The result of the action of the anti-engine is to slowly time-reverse the damaged cell and all its parts back to a previous state and dynamics. Electromagnetic amplification of the process was unwittingly demonstrated by Priore {737} and by Becker {738}. We refer the reader to our website {739} and to our "porthole briefing" for pertinent technical information, and for a most important extension and great simplification of the Priore/Becker approach and methodology.

Present classical thermodynamics does not consider or model the reaction of local spacetime curvatures and their dynamics upon the system. Hence all time-domain pumping that occurs is occurring rather randomly in each and every microscopic part of the system. In short, there is no organized anti-engine, and an organized anti-engine is what is required for time-reversing the system's operations back to a previous state. However, by mimicking, the body and pumping the physical process in the time-domain, with sufficient pumping a precise, amplified anti-engine will be formed and act upon the system — *any* system. The applicability is limited only by the state of development of the appropriate time-pumping technology.

In theory (and as experimentally demonstrated unwittingly by Priore and by Becker), this anti-engine can and does overpower the resident engine. It can in fact time-reverse the pumped physical processes in the system itself.

So the classical thermodynamics assumption of irreversibility for heat engine energy processes is not absolute but only provisional. Specifically, it assumes no overall time-domain pumping process that provides a precise

anti-engine and time reversal of the system energetic process of concern and its dynamics.

If the second law is extended to encompass and model the new concepts such as broken symmetry and time-energy, then the extended second law will encompass reversible heat engine processes, Maxwell's demons,  $COP > 1.0$  electrical systems,  $COP \gg 1.0$  electrical systems (electrical windmills), time-reversal of the dynamics, reversibility of that which has been irreversible, etc.

As given by Kondepudi and Prigogine, the third law of thermodynamics essentially states {740} that

*"... at the absolute zero of temperature the entropy of every chemically homogeneous solid or liquid body has a zero value."*

This is also known as Nernst's heat theorem, after W. Nernst who proposed it in 1906. The third law states that

$$S \rightarrow 0 \text{ as } T \rightarrow 0 \quad [9]$$

Certain violations of the third law are already known. E.g., C=O: carbon monoxide molecules can align in various ways in a crystal, so there is entropy associated with C=O crystals at 0°K. In this case, A and B are equally probable and the following equation can be used to calculate the entropy (called residual energy):

$$S = nR [1/2 \ln(1/2) + 1/2 \ln(1/2)] = -nR \ln 2 \quad [10]$$

From the new viewpoint, the definition of  $T = 0^\circ$  is open to change. Rigorously, the present third law assumes no local broken 3-symmetry of the vacuum's flux exchange with the system, and it also assumes no broken time-energy flow symmetry. In the new approach, both these symmetries can and are broken by every charge while a higher 4-symmetry is maintained. This leads to a giant negentropy, so that the "calculation of entropy" via Nernst's theorem fails. A fundamental charge at  $T = 0^\circ$  thus continues to exhibit giant negentropy, in total violation of the third law of classical thermodynamics. Hence the third law is also devoid of any absoluteness, and it is reduced to a special case statement. It remains useful where the more esoteric energy interactions are negligible.

We have now demonstrated (by citing actual substantiating experiments) that all the laws of CTD are falsifiable insofar as being absolute. Hence they have *no* absoluteness. Instead, they are special case models and "approximation laws" only. They remain very useful and applicable,

However, so long as the more esoteric energy interactions of the supersystem do not play a major role in the system operation.

We conclude that the present form of classical thermodynamics and disequilibrium thermodynamics are special case models — as indeed is every model, by Godel's theorem and proof alone — with no absoluteness. They do not prohibit  $COP > 1.0$  EM systems, nor can they necessarily be used to rule out  $COP > 1.0$  EM systems.

This also falsifies all current arguments that  $COP > 1.0$  EM systems violate either the first, second, or third law of classical thermodynamics. Calling  $COP > 1.0$  systems "perpetual motion machines of the first, second, and third kind", according to which law they supposedly violate, is a total non sequitur. Indeed, every original charge in the universe has already demonstrated just such "perpetual motion" for some 14 or so billion years, and happily violates all three laws of the present CTD. Every charge is in violation of the "laws" of the present models of CTD, CED, and EE, and it is still in motion and still freely pouring out EM energy. We have no ability to examine the notion of "perpetual" past the entire past existence of the universe.

All three models examined — CTD, CED, and EE — are seriously out of date and in need of revision and extension, because any absoluteness of their predictions and assumptions is already falsified by actual experiments and examples. Some work is already ongoing to extend thermodynamics, but is not nearly extensive enough. A thorough overhaul of the very foundations is what is needed for all three models. The three models remain useful as special case approximations, but their received use to arbitrarily rule out  $COP > 1.0$  EM systems is dogma, not science because such use is already experimentally refuted by every charge in the universe.

# Appendix B

## Maxwell's Demon: Alive and Thriving

### Introduction

ITHERE is a long history of discussion over "Maxwell's demon", a fictitious being that Maxwell proposed to "sort" molecules striking a barrier between two volumes of gas initially at the same temperature. By intentionally opening a trap door between two for hotter, more energetic molecules to pass through from the left side to the right side, but shutting the door for lower temperature molecules so that they are retained on the left side, eventually a temperature gradient would "freely" exist between the two reservoirs. In theory, then, if one had the demon working "for free", one would be able to utilize the temperature difference between the reservoirs to perform free work. Then one could repeat the demon's sorting procedure, to obtain more free work again. And soon.

The prevailing discussions have ignored the main feature: the fact that the demon is part of the "external environment" (i.e., not under control of the system, and operating independently of any energy input by the operator). Maxwell's demon represents an analogy to the system's environment furnishing free energy (free ordering and sorting). A lot of breath and mental gyrations have gone into the discussions over the years, with very little concrete experimental examination. The prevailing concept in science, which still adheres to the "absoluteness" of the second law of thermodynamics, is that Maxwell's demon is impossible.

Recently, the former editor of *Nature*, Dr. John Maddox, wrote a very clear emeritus editorial on Maxwell's famous demon, repeating the standard conclusion that such is not possible. Since there are specific examples in physics of what can be called "experimentally proven Maxwell's demons," the present author prepared a respectful commentary to *Nature* to refute the standard erroneous thesis in the interest of science. Since experiment is supposed to be decisive in physics, we hoped that citing overwhelming experimental proof would be sufficient. It wasn't.

*Almost* symbolically (i.e., "free the demon!"), I submitted the commentary to the editor by I -mail on the evening of July 4, 2002. The very next day I received rejection (not too unexpected) by E-mail with no further discussion accepted. So I wrote a polite note in response, and then posted my commentary note on my website.

In this appendix, I include my E-mails of both 4 July and 5 July 2002, and then include the commentary that was submitted. The reader can read the cited emeritus editorial in *Nature*, and then decide for himself or herself whether experiment still rules the day at *Nature* where  $COP > 1.0$  and  $COP = co$  EM systems are concerned.

E-mail to *Nature* 4 July 2002, submitting the Commentary.

Dear Editor:

Attached is a significant commentary on John Maddox's excellent emeritus editorial on Maxwell's demon, titled "Slamming the Door," *Nature*, 417, 27 Jun. 02, p. 903.

Forms of Maxwell's demon are very much alive and thriving, and experimentally confirmed, as we develop very clearly in this commentary. They are unwittingly used widely in electrodynamics, though seldom recognized.

Most sincerely,  
Tom Bearden, Ph.D., Magnetic Energy Ltd.

E-mail to *Nature* 5 July 2002, submitting a comment on the rejection.

Dear Ms XXX:

Thanks for the prompt reply.

Since *Nature* will not be publishing the note, I have now posted it on my website (some 80,000 hits per day from all over the world). It can be **seen** at <http://www.cheniere.org/articles/maxwells%20demon.htm>

This is a respectful article, and I just thought the experimental information needed getting out there to the scientific community. I also understand you cannot discuss it further. I only wish to note that it is based on cited replicable experiments, which are supposed to be the decisive thing in science and scientific method. It seems a bit odd that you would not publish the results of several replicable and replicated experiments **that** falsify a prevailing theoretical thesis and conclusion. Nonetheless, I respect the wishes of *Nature*, and I do enjoy the Journal each week.

Best wishes,  
Tom Bearden, Ph.D.

Within days of this rejection, the paper by Wang et al. [741] was published, extending the known physics "Maxwell's demon" regime (i.e., where the second law of thermodynamics is known to be violated) from the atomic scale and very short periods of time, to the micron scale in size and time up to a few tenths of a second.

Here is the rejected commentary I submitted to *Nature*.

## Maxwell-type demons are alive and thriving

The recent emeritus editorial by Maddox on Maxwell's demon [742] is a short overview of one historical aspect of would-be negentropy, but much greater thought on the subject needs to be given. Indeed, Maxwell's demon is alive and thriving, but just in a different form not requiring a nimble-fingered microscopic being. We now discuss such experimentally proven demons.

Consider the prevailing ansatz that Maxwellian systems outputting more EM energy than the energy input by the operator or experimenter are impossible. Such proposed systems are said to constitute examples of forbidden perpetual motion machines because they violate the second law of classical (equilibrium) thermodynamics. That prevailing ansatz has been falsified in classical electrodynamics since the 1880s, and in particle physics for 45 years, but eerily it is still the prevailing scientific opinion nonetheless.

The ansatz can be experimentally disproved in classical electrodynamics as follows: Lay a charged capacitor or electret on a permanent magnet so the E-field of the capacitor or electret is at right angles to the H-field of the magnet. That optimizes  $\mathbf{S} = \mathbf{E} \times \mathbf{H}$ , and hence optimizes the continuous flow of Poynting EM energy from that simple device, even though the fields, seem to be "static". As Buchwald states [743], "*Poynting's result implies that a charged capacitor in a constant magnetic field which is not parallel to the electric field is the seat of energy flows even though all macroscopic phenomena are static.*" [744] This simple device will freely pour EM energy indefinitely, so long as it remains intact.

We consider a special but universal kind of related Maxwell's demon problem: the vexing problem of the source charge, sometimes called "the most difficult problem in classical and quantum electrodynamics." [745] Any charge pours out observable EM energy continuously in all directions, at the speed of light, with no *observable* EM energy input. This continuous flow of EM energy establishes the charge's related fields and potentials and their energy, reaching even across the universe for very old charges. In

the classical electrodynamics (CED) model and therefore in electrical engineering, there is no solution to this problem because CED does not model *nonobservable* EM energy inputs such as the virtual particle flux exchange of the charge with its vacuum environment.

With no solution available in CED, then the present CED and electrical engineering assume that every charge in the universe *freely and continuously creates energy out of nothing*, and pours it out in all directions, forming its associated fields and potentials and their energy. Either we must solve the problem in the classical EM model, or totally surrender the conservation of energy law in the model in its present limited form. Or — as is presently the case — we may continue to ignore it, as has been done during the 45 years since the proof of broken symmetry in particle physics [746].

On the other hand, particle physics models and utilizes virtual energy **in** the seething vacuum, including the interactions of the vacuum with charge, With the 1957 experimental proof of broken symmetry by Wu et al., [746] certified by the award of the Nobel Prize to Lee and Yang later that **same** year, one of the proven broken symmetries in the vacuum virtual energy exchange is the asymmetry of opposite charges, such as are on the ends of a dipole. For a dipole or dipolarity, then by the very definition of broken symmetry *something virtual has become observable*. We diverge for a moment, and then will return to this proven asymmetry of the opposite charges of the dipole.

If we take the modern view of the bare charge clustered by virtual **charges** of opposite sign, then the magnitude of the bare charge in the middle is infinite (including its energy) and so is the magnitude of the charge of the surrounding clustering virtual charges. [747] So for an "isolated **observable** charge" we actually have a sort of "infinitely powerful dipole". Yet **the** difference between these two infinite values of charge is finite; it is routinely calculated as the observed charge of an elementary charged particle, the value that is listed in standard texts and handbooks. The asymmetry of this "opposite composite charges" model of the "isolated observable charge" now explains the long-vexing source **charge** problem. The observable "composite" charge continuously absorbs **virtual** photon energy from the seething vacuum exchange, transduces it **into** observable photon energy excitation, and this excited state **continuously** decays to emit real observable photons in all directions at the speed of light. When *virtual* energy input as well as *observable* energy output is accounted, the charge's proven asymmetry in the vacuum exchange **makes** the source charge an open system far from equilibrium in its active

environment. As an open disequilibrium system the charge is thermodynamically permitted to (1) self-order (hence coherently integrate absorbed virtual photon energy into observable photon energy), (2) self-oscillate or self-rotate (spin), (3) output more energy than the "operator" **inputs** (the operator inputs none at all), and (4) exhibit negentropy. Every charge in the universe is already doing those four functions. It is also a system having a COP (coefficient of performance, or useful energy output divided by the operator's energy input) of  $COP = \infty$ , since the operator inputs nothing.

**Inshort**, every charge in the universe already is a special kind of known "Maxwell's demon", whose operational mechanism is long since proven in particle physics but does not appear in classical electrodynamics or electrical engineering. It is a dependable Maxwell's demon, since all charges in the original matter in the universe have been pouring out real EM energy freely, using this asymmetry mechanism, for some 14 billion years, **and** they continue to do so. Further, any charge one assembles in the laboratory instantly starts up its Maxwellian demon performance automatically, and it will continuously pour out EM energy in all directions indefinitely, so long as the charge remains intact. So this demon is **easily** created and demonstrated experimentally. The Maxwell's demon *for* freely extracting copious EM energy from the vacuum is one of the easiest entities to invoke in all of physics

This is **not** a violation of thermodynamics, since classical *equilibrium thermodynamics* with its infamous second law does not apply because the charge is far from equilibrium in its exchange with its active vacuum environment. Although the  $COP = \infty$ , the *efficiency* of the charge system - defined as the useful energy output divided by the total energy input from all sources — is never more than 100%. Hence this is not a perpetual motion machine, and the charge rigorously does not create energy; it only transduces energy input to it in a novel form. In this case, the charge can permissibly act as if it were a free electrical windmill turning in a novel free electrical wind due to its asymmetry in the vacuum flux.

So every charge in the universe exhibits  $COP = \infty$ , clearly proving that Maxwell's demon in an improved form exists and is thriving throughout the universe. There would be no EM fields and potentials and their energy, and hence no electrical circuits or power systems, were it not for this asymmetry of the charge in its virtual energy exchange with the vacuum, making the charge a true Maxwell's demon.



In the usual CED model and electrical engineering, the 1867 L. V. Lorentz symmetrical regauging (later credited to H. A. Lorentz) [748] of the equations carefully selects only those Maxwellian systems that have two simultaneous equal and opposite disequilibria with their active environment. This assumes that the potential energy of the system is freely changed twice (by gauge freedom), but only in such highly selected manner as to form two equal and opposite new "free" force fields in the system. These two force fields perform *internal work* inside the system continuously, increasing its stress (and its stress potential, thereby curving local spacetime). Since there is no *net resultant* force field, the two force fields are unable to translate electrons in the circuit to do free *external work* in the external load. So the symmetrically regauged Maxwellian system has been altered: its energy has been changed twice, forming a stress potential inside it and increasing and maintaining that stress on the system, and the frame of the system has been somewhat rotated out of **the** laboratory frame. The symmetrically regauged Maxwellian system most decidedly is not identical to the system prior to regauging.

We note merely that the common Lorentz symmetrical regauging unwittingly assumes two Maxwell's demons of yet different kind, each freely fueled from the local vacuum environment, and each continuously performing internal work upon the system to produce and maintain system stress.

Gauge freedom is thus revealed as a special kind of Maxwell's demon, since (1) it assumes that the potential energy of a system can be freely changed at will at any time, and (2) unless we abandon the conservation of energy law, that energy change must have involved energy exchange **with** the external environment. So the gauge freedom axiom of quantum field theory assumes two specialized Maxwellian demons — i.e., mechanisms for transfer of energy between environment and system, so as to continuously perform internal work upon the system. In this case the two demons are equal and opposite, and fight each other to a draw insofar as performing any useful external work.

Oddly, in present electrical circuits the ubiquitous but *arbitrary* closed current loop circuit — passing all spent current from the external circuit back through the source dipole in the generator against the dipole's **back** emf— self-imposes Lorentz regauging of excitation discharge in the circuit and prevents COP>1.0 functioning. This is not required by thermodynamics in general! Indeed, several areas are already known to violate present thermodynamics. Sharp discharges (strong gradients), for example, are known to violate it. [749] Other known areas where

thermodynamics is violated include rarefied media, and anomalous memory effects in materials. Modern research is being conducted in such areas under the heading of "extended thermodynamics". [750].

Since experiment and not theory is primary in science, let us consider some additional actual Maxwell demon experiments. The well-known "negative resonance absorption of the medium" produces more output energy than the operator inputs to the experiment, with hundreds of these experiments done every year routinely by many nonlinear optical laboratories. As an example, Bohren's version of such an experiment [751] commonly outputs 18 times as much EM energy as the operator inputs, exhibiting  $COP = 18$ . Independent replication of Bohren's work by Paul and Fischer [752] is reported in the same journal issue.

Added to the charged capacitor lying on a permanent magnet, there thus exist plenty of proven, replicated experiments which can be easily performed to demonstrate a Maxwellian demon operating in a Maxwellian system and freely producing  $COP > 1.0$ , or even  $COP = \infty$ . Because of the demon (the operational mechanism), these experiments all involve open systems far from equilibrium with their active environment. Hence they are not limited by the second law of classical equilibrium thermodynamics.

In short. Maxwell's demon is very much alive in many forms and is thriving after all. It has just been hiding in different form than what is usually suspected.

T.E. Bearden, Ph. D.  
Magnetic Energy, Ltd.

# ENDNOTES

1. (a) Albert Einstein, "Foreword," in (b) Max Jammer, *Concepts of Space: The History of Theories of Space in Physics*, Harvard University Press, Cambridge, Massachusetts, 1969, p. xi-xii.

2. George Zebrowski, "The holdouts," *Nature*, Vol. 408, 14 Dec 2000, p. 775; expressing the thinking of Stephen Hawking, one of the leading physicists of our day.

3. Mario Bunge, *Foundations of Physics*, Springer-Verlag, New York, 1967, p. 176.

4. (a) J. H. Poynting, "On the transfer of energy in the **electromagnetic** field," *Phil. Trans. Roy. Soc. Lond.*, Vol. 175, Part II, 1884, p. 343-361; (b) — "On the Connection Between Electric Current and the Electric and Magnetic Inductions in the Surrounding Field," *Phil. Trans. Roy. Soc. Lond.*, Vol. 176, 1885, p. 277-306.

5. (a) Oliver Heaviside, "Electromagnetic Induction and Its **Propagation**," *The Electrician*, 1885, 1886, 1887, and later — a series of 47 sections, published section by section in numerous issues of *The Electrician* during 1885, 1886, and 1887; (b) — *Electromagnetic Theory*, 3 vols., Benn, London, 1893-1912. Second reprint 1925. An unabridged edition of all three volumes, with a critical and historical introduction by **E. Weber**, was published by Dover, New York, 1950. See particularly (c) - "On the Forces, Stresses, and Fluxes of Energy in the Electromagnetic Field." *Phil. Trans. Roy. Soc. London*, 183A, 1893, p. 423-480. In this prestigious publication, Heaviside discusses the Faraday-Maxwell ether medium, outlines his vector algebra for analysis of vectors without quaternions, discusses magnetism, gives the EM equations in a moving medium, and gives the EM flux of energy in a stationary medium. On p. 443, he credits Poynting with being first to discover the formula for energy flow, with Heaviside himself independently discovering and interpreting this flow a little later by himself in an extended form.

6. E.g., a polite debate has continued at intervals, for about 30 years, in the *Am. J. Phys.* alone.

7. Richard P. Feynman, Robert B. Leighton, and Matthew Sands, *The Feynman Lectures on Physics*, Addison-Wesley, Reading, MA, Vol. 1,

8. *Ibid.*, Vol. 1, 1964, p. 12-2.
9. *Ibid.*, Vol. 2, 1964, p. 2-1.
10. John D. Kraus, *Antennas*, Second Edition, McGraw Hill, 1988.
11. Raymond A. Serway, *Physics for Scientists and Engineers with Modern Physics*, Third edition, updated version, Saunders College Publishing, Philadelphia *et al*, 1990, p. 620.
12. T. E. Bearden, "Giant Negentropy from the Common Dipole," *J. New Energy*, 5(1), Summer 2000, p. 11-23. Also on website [www.cheniery.org](http://www.cheniery.org).
13. (a) T. D. Lee, "Question of Parity Conservation in Weak Interactions," *Phys. Rev.*, 104(1), Oct. 1, 1956, p. 254-259; (b) — with Reinhard Oehme and C. N. Yang, "Remarks on Possible Noninvariance under Time Reversal and Charge Conjugation," *Phys. Rev.*, 106(2), 1957, p. 340-345; (c) — and C. N. Yang, "Parity Nonconservation and a Two Component Theory of the Neutrino," *Phys. Rev.*, 105(5), Mar. 1, 1957, p. 1671-1675.
14. C. S. Wu, E. Ambler, R. W. Hayward, D. D. Hoppes and R. P. Hudson, "Experimental Test of Parity Conservation in Beta Decay," *Phys. Rev.*, Vol. 105, 1957, p. 1413.
15. We published it crudely two years later. See T. E. Bearden, *Quiton/Perceptron Physics: A Theory of Existence, Perception, and Physical Phenomena*, NTIS Report AD-763-210, 1973.
16. A time-reversal zone is a momentary tiny region of the fluid wherein antiphoton reactions with the main ions predominate over **photon** reactions.
17. See T. E. Bearden, "EM Corrections Enabling a Practical Unified Field Theory with Emphasis on Time-Charging Interactions of Longitudinal EM Waves," *J. New Energy*, 3(2/3), 1998, p. 12-28. A slightly expanded paper by the same title is published in *Explore*, 8(6), 1998, p. 7-16.
18. E.g., see Xiaodong Chen, "A New Interpretation of Quantum Theory — Time as Hidden Variable," Los Alamos National Laboratory web site, arXiv:quant-ph/9902037 v3, 11 Feb. 1999. Using two more **time** variables as the quantum hidden variables, Chen derives Dirac's field equation under the principle of quantum physics, and then extends **the**

method into quantum fields with arbitrary spin number. Chen's model offers very interesting unifications of quantum mechanical behavior.

19. F. Mandl and G. Shaw, *Quantum Field Theory*, Wiley, 1984, Revised Edition 1993, Chapter 5. This is a deeper coverage of the photon polarization. Mandl and Shaw argue that the longitudinal and scalar (time-polarized) polarizations are not directly observable, but only in combination, where they manifest as the "instantaneous" Coulomb (i.e., electrostatic) potential. This argument, translated from particle terminology to wave terminology, directly fits and strongly supports my reinterpretation {12} of Whittaker's 1903 wave decomposition of the scalar potential {85}. The reinterpretation also represents the discovery of the giant negentropy process favored by nature, easily evoked by breaking 3-symmetry (as by forming a simple dipole).

20. James Clerk Maxwell, "A Dynamical Theory of the Electromagnetic Field," *Roy. Soc. Trans.*, Vol. CLV, 1865, p 459. Read Dec. 8. 1864. Also in *The Scientific Papers of James Clerk Maxwell*, 2 vols, bound as one, edited by W. D. Niven, Dover, New York, 1952, Vol. 1, p. 526-597. In this seminal paper, Maxwell's equations of the electromagnetic field are given in "Part III, General Equations of the Electromagnetic Field," p. 554-564. On p. 561, Maxwell lists his 20 variables. On p. 562, he summarizes the different subjects of the 20 equations, being three equations each for magnetic force, electric currents, electromotive force, electric elasticity, electric resistance, total currents; and one equation each for free electricity and continuity.

21. B. J. Hunt, *The Maxwellians*, Cornell University Press, 1991 gives the history of the alteration of Maxwell's field theory by Fitzgerald, Heaviside, Lodge, and Hertz. In an appendix, Hunt makes a comparison between the standard expressions of the Maxwell field equations and their expression in quaternionic form.

22. E.g., J. D. Jackson, *Classical Electrodynamics*, 2nd Edition, Wiley, 1975, p. 219-221.

23. Willis E. Lamb Jr. and Robert C. Retherford, "Fine structure of the hydrogen atom by a microwave method," *Phys. Rev.*, 72(3), Aug. 1, 1947, p. 241-243. Lamb received the 1955 Nobel Prize in physics jointly with Polykarp Kusch for experiments measuring the small displacement later called the "Lamb shift" of one of the energy levels in atomic

hydrogen. This is a small "vacuum energy" effect, but the *energy density* involved is greater than the surface energy density of the sun.

24. Craig F. Bohren, "How can a particle absorb more than the light incident on it?" *Am. J. Phys.*, 51(4), Apr. 1983, p. 323-327. Under nonlinear conditions, a particle can absorb more energy than is in the light incident on it. Metallic particles at ultraviolet frequencies are one class of such particles; insulating particles at infrared frequencies are another.

25. See also H. Paul and R. Fischer, "(Comment on "How can a particle absorb more than the light incident on it?")," *Am. J. Phys.*, 51(4), Apr. 1983, p. 327 for a replication and validation of Bohren's experiment,

26. H. B. G. Casimir, "On the attraction between two perfectly conducting plates," presented at a meeting of the Royal Netherlands Academy of Arts and Sciences on 29 May, 1948. Published in the same year in *Proc. Koninklijke Nederlandse Akad. van Wetenschappen*, Amsterdam, vol. 51(7), 1948, p. 793-796. In English. It is an extrapolation of the more detailed paper of Casimir and Polder, 1948.

27. S. K. Lamoreaux, "Demonstration of the Casimir Force in the 0.6 to 6 micro mrange," *Phys. Rev. Lett.*, 78(1), Jan. 6, 1997, p. 5-8. Lamoreaux gives a rigorous experimental verification of the Casimir effect.

28. Franklin B. Mead and Jack Nachamkin, "System for Converting Electromagnetic Radiation Energy to Electrical Energy," U.S. Patent No 5,590,031. An invention for extracting energy from the vacuum via the proven Casimir effect.

29. (a) Floyd Sweet and T. E. Bearden, "Utilizing Scalar Electromagnetics to Tap Vacuum Energy," *Proc. 26th Intersociety Energy Conversion Eng. Conf. (IECEC '91)*, Boston, Massachusetts, 1991, p. 370-375. Sweet's device produced 500 watts output from a 33 microwatt **input** by the operator. A highly successful anti-gravity experiment designed by the present author was also performed, and is reported in the paper. Unfortunately, Sweet later died and never fully revealed the activation secret by which barium ferrite magnetic materials could be in self-oscillation at 60 Hertz. Weak self-oscillation of such permanent magnetic materials at higher frequency is now known, of course. E.g., see (b) V. E. Zakharov and V. S. L'vov, "Parametric excitation of spin waves in ferromagnets with magnetic inhomogeneities," *Sov. Phys. Solid State*, 14(10) 1973, p. 2513. Particularly see (c) V. S. L'vov, *Wave Turbulence Under Parametric Excitation: Applications to Magnets*, Springer Series in

Nonlinear Dynamics, Springer-Verlag, New York, 1994. Self-oscillation can in fact be induced in permanent magnet materials. We comment that, while a permanent magnet is in self-oscillation, a simple set of wires or a coil around the magnet will receive EM energy by induction, and can power a very tiny load in a closely adjacent circuit.

30. T. E. Bearden, "Bedini's Method for Forming Negative Resistors in Batteries," *J. New Energy*, 5(1), Summer 2000, p. 24-38. Also carried on restricted DoE website <http://www.ott.doe.gov/electromagnetic/> and on the present author's open website <http://www.chenierye.org>.

31. Teruo Kawai, "Motive Power Generating Device," U.S. Patent No. 5,536,518. Jul. 25, 1995. My board of directors and I were physically present when the Kawai system, company, etc. were seized by what can only have been the Yakuza (Japanese mafia), even though Kawai was being backed by one of the wealthiest investors in Japan. I had just reached an agreement with Kawai to produce and market his overunity motor worldwide. Several legitimate Japanese overunity systems, ready for production, have been stopped in this fashion. Kawai's process, applied with efficient switching such as photon-coupled switching, essentially doubles the COP of the motor to which it is applied. If one starts with a high efficiency (e.g., Hitachi) permanent magnet electric motor of 0.7 or 0.8, one can expect to produce COP = 1.4 and 1.6 respectively, the actual results obtained by Hitachi tests of two Kawai-modified Hitachi motors. We accent that the efficiencies of the motors remain less than 100% at all times.

32. Gabriel Kron, "Electric circuit models of the Schrodinger equation." *Phys. Rev.* 67(1-2), Jan. 1 and 15, 1945. Quoting, p. 41: *"Now a value E of the negative resistances, at which the generator current becomes zero, represents a state at which the circuit is self-supporting and has a continuous existence of its own without the presence of the generator, as the negative resistances just supply the energy consumed by the positive resistances. ... When the generator current is positive the circuit draws energy from the source, and when the current is negative the circuit pumps back energy into the source. At zero generator current the circuit neither gives nor takes energy, and theoretically the generator may be removed."* In this passage, Kron was required to insert the word "theoretically". Kron was the chief scientist for General Electric on the Network Analyzer project at Stanford University before WW II. In the 1930, he did successfully build negative resistors (at least three), and he

did successfully power the network analyzer with them. He was never permitted to release the technical details, although he placed judicious hints in several of his papers, and slipped certain key phrases past the censors. Interestingly, Sweet was his protegee, and it is conceivable that the basis for Sweet's device may have been Kron's original negative resistor. Independent tests and verification of the Sweet device were performed by Walter Rosenthal, a retired professional test engineer of considerable experience.

33. Shoukai Wang and D. D. L. Chung, "Apparent negative electrical resistance in carbon fiber composites," *Composites, Part B*, Vol. 30, 1999, p. 579-590. Apparently the referees required the replacement of the term "negative electrical resistance" by the term "apparent negative resistance". In the paper, simply examine the actual results shown in the curves of the negative-going current, against the voltage, with the line passing directly through the origin. That is a true negative resistance, not a differential one or an "apparent" one. A patent was filed on this invention.

34. (a) T. H. Moray, *The Sea of Energy*, 5th Edn., Salt Lake City, 1978. The Moray device weighed 55 pounds and produced 50 kilowatts of power in the late 1930s, and was demonstrated to scientists and engineers numerous times, Moray made tubes which actually contained very special semiconductors, three of them in contact, each pressed at high pressure during a sintering process. A very eerie chain of circumstances eventually destroyed the device. Moray rode in a bulletproof car, and he was sometimes fired at from the sidewalk or an alley. A double agent, working for both the U.S. and the Soviet Union, infiltrated his lab and eventually destroyed the device. The Morays were never given a proper scientific hearing and were never funded for full development. T. Henry Moray was shot and wounded in his own laboratory, wrestling with a would-be assassin. Yet so many expert engineers and scientists witnessed and tested the machine in operation that there is no question of its legitimacy. Unfortunately, the reference cited is not at all a satisfactory scientific examination of the Moray device. A related U.S. patent was issued which at least shows some details of the Moray tube: See (b) Thomas H. Moray, "Electrotherapeutic Apparatus," U.S. Patent No. 2,460,707, Feb. 1, 1949. I personally received a treatment on a Moray device for severe pain, and the relief was rapid and remarkable.

35. See (a) William B. Burford III and H. Grey Verner, *Semiconductor Junctions and Devices: Theory to Practice*, McGraw-Hill,



New York, 1965, Chapter 18: Point-Contact Devices. The very first transistor — the point contact transistor — also often exhibited negative resistance. Quoting, p. 281:

*"First, the theory underlying their function is imperfectly understood even after almost a century..., and second, they involve active metal-semiconductor contacts of a highly specialized nature. ... The manufacturing process is deceptively simple, but since much of it involves the empirical know-how of the fabricator, the true variables are almost impossible to isolate or study. ... although the very nature of these units limits them to small power capabilities, the concept of small-signal behavior, in the sense of the term when applied to junction devices, is meaningless, since there is no region of operation wherein equilibrium or theoretical performance is observed. Point-contact devices may therefore be described as sharply nonlinear under all operating conditions."*

Certainly degenerate four-wave mixing and therefore time reversal can occur in semiconductors. E.g., see (b) R. K. Jain, "Degenerate four-wave mixing in semiconductors: application to phase conjugation and to picosecond-resolved studies of transient carrier dynamics." *Opt. Eng.*, 21(2), March/April 1982, p. 199-218. We also point out that hole current can be emitted from an n-type semiconductor having a metallic point placed on its surface, and hole current will move against the voltage (electron current view). A process (patent pending) by Bedini and Bearden have shown that a capacitor may be charged by hole current, and then discharge electron current, effectively transducing negative energy into positive energy. It is therefore possible (Bedini's method) to switch a capacitor from a hole-current charging circuit by a hole-emitting process, to a bypass capacitor across a source such as a battery after the capacitor has reached higher charge voltage than the source. The capacitor will then charge the battery and power the circuit as well, during that portion of its discharge cycle while its voltage is above that of the battery. This is a legitimate COP > 1.0 process, invented by Bedini.

36. (a) William Jay Fogal, "High Gain, Low Distortion, Faster Switching Transistor." U.S. Patent No. 5,196,809, Mar. 23, 1993; (b) — "High Gain, Low Distortion, Faster Switching Transistor." U.S. Patent No. 5,430,413, July 4, 1995. The Fogal semiconductor can be rigged to perform the permitted degenerate four-wave mixing and therefore time reversal. It can thus be rigged as a true negative resistor, where the current moves against the voltage.

37. Stephen L. Patrick, Thomas E. Bearden, James C. Hayes, Kenneth D. Moore, and James L. Kenny, "Motionless Electromagnetic Generator," U. S. patent # 6,362,718, March 26, 2002.
38. (a) T. E. Bearden, "Energy from the Active Vacuum: The Motionless Electromagnetic Generator," in M. W. Evans (Ed.), *Modern Nonlinear Optics*, Second Edition, Wiley, 2001, Part 2, p. 699-776; (b) M. W. Evans, P. K. Anastasovski, T. E. Bearden *et al.*, "Explanation of the Motionless Electromagnetic Generator with  $0(3)$  Electrodynamics," *Found. Phys. Lett.*, 14(1), Feb. 2001, p. 87-94; (c) M. W. Evans, P. K. Anastasovski, T. E. Bearden *et al.*, "Explanation of the Motionless Electromagnetic Generator by Sachs's Theory of Electrodynamics," *Found Phys. Lett.*, 14(8), Aug. 2001, p. 387-393.
39. A version of the MEG was also independently replicated by J. L. Naudin. See his website at <http://jnaudin.free.fr/html/meg.htm> .
40. T. E. Bearden, "Dark Matter or Dark Energy?", *J. New Energy*, 4(4), Spring 2000, p. 4-11.
41. See Chapter 4 for a high-level expose of this methodology.
42. Sweet and Bearden, {29a). Sweet performed an antigravity experiment designed by the present author, and successfully reduced **the** weight of an object on the laboratory bench, by 90%. Sweet's solid state magnetic vacuum triode amplifier produced a COP = 1,500,000, so a **very** appreciable Dirac sea hole current was available to work with. Conversion of the Dirac sea hole current into electrical current via the present Bedini-Bearden process would have eliminated the antigravity and produced a very large increase in output electrical power.
43. See (a) T. E. Bearden, "The Unnecessary Energy Crisis: How to Solve It Quickly," ADAS Position Paper, June 2000; (b) Bearden **{12}**; (c) Bearden {30}; (d) T. E. Bearden, "EM Energy From The Vacuum: Ten Questions With Extended Answers," September 2000. The present author has been calling for just such a program. These papers are on restricted DOE Website <http://www.ott.doe.gov/electromagnetic/> and also are on the author's website at <http://www.cheniery.org>.
44. Nathan Smith, "Marketable Results vs. Good Science?," *Sci. Am.* , 284(5), May 2001, p. 8-9. Quote is from p. 9.
45. This is the actual phrase often used in such Government contracts. What it means is that the Government (which means the government

employee controlling that program and its funds) can suddenly declare that the Inventor is not getting his invention developed rapidly enough, and the Government then seizes the patent to "get it developed more quickly".

The inventor is suddenly left hanging, no longer in control of his own intellectual property. Or the Government has the power to block developmentaltogether.

46. Often the universities just bluntly state that *all patents revert to the university*.

47. Hal Hellman, *Great Feuds in Science*, Wiley, New York, 1998.

We particularly call attention to Hellman's dissertation on Wegener's persecution. Today, the legitimate overunity EM researcher and the cold fusion researcher are regarded much like Wegener was regarded — as the very epitome of a fool. This label is appended by "experts" who are not even aware of what really powers an EM circuit or an electrical power distribution system.

48. A photon is a piece of angular momentum (called "action" by the physicist), consisting of a little piece of spatial energy ( $\Delta E$ ) and a little piece of time ( $\Delta t$ ), welded together as  $(\Delta E)(\Delta t)$  with no seam in the middle, so to speak. But now look at that little  $(\Delta E)(\Delta t)$  Since the photon is quantized  $(\Delta E)(\Delta t) = k = \hbar$ . Any change in  $(\Delta E)$  requires that  $(\Delta t)$  change inversely; i.e.,  $(\Delta E) = \hbar / (\Delta t)$ . So increasing  $(\Delta E)$  decreases  $(\Delta t)$  accordingly. Let us call the spatial energy  $s$  compacted into  $(dt)$  the equivalent energy of the photon. Then  $s$  is given by  $s = c^2(\Delta t) = 9 \times 10^{16} (\Delta t)$ . So as the frequency of a photon lowers, the  $(\Delta t)$  time component increases proportionally, and the total equivalent energy in the photon increases dramatically by many orders of magnitude! As an example, suppose we halve the spatial energy  $(\Delta E)$  that doubles the original time interval  $(\Delta t)$ , which gives the new  $s = c^2(2\Delta t)$  or  $s = 2c^2(\Delta t)$  for the new equivalent energy. So while we halved the *normal* spatial energy formally transported by the photon, we multiplied the *equivalent* time-energy by the enormous factor of  $2c^2$  which is approximately  $18 \times 10^{16}$  in the MKS system. It follows that, if we use the equivalent time) energy of the photon and transduce a little of it into normal spatial energy, the energy density of those nuclear reactions now seen only in distant energetic objects such as pulsars, exploding stars, etc. can be achieved right on the laboratory bench. *The highest energy physics has not yet been born in the physics community, and what is presently being done in the high-energy*

*accelerators is child's play compared to what can be done with time-energy engineering.*

49. To see by another method that time is energy, one notes that the choice of fundamental units chosen for one's physics model is arbitrary. So we choose a single fundamental unit, the joule, to make a new physics model. Thereupon all other entities are energy and energy functions only. Hence, time is totally a function of energy. Actually, time is spatial energy compressed by the factor  $c^2$ , so it has the same energy density as mass, except the highly compressed spatial energy is placed in the time domain to appear at "time" rather than in 3-space to appear as "mass".

50. E.g., in cold fusion experiments where the time-energy is partially transduced in a time-reversed manner, the gluon forces binding the quarks in the affected neutrons and protons are dramatically reduced and the quarks are therefore nearly freed. This is being done in an apparatus of perhaps two cubic feet in volume, rather than a giant accelerator 20 miles in diameter and costing billions of dollars. So far, the largest accelerator using 3-space (decompressed) energy is just a bit short of the energy required to free the quarks. Use of time (compressed) energy allows such reaction as freeing the quarks to be easily accomplished, while the accompanying decompressed *spatial* energy is very low.

51. Time energy has the same energy density as mass, but that highly compressed energy has just been placed in the 4th axis *ict* of Minkowski space rather than in 3-space. In *ict* the only variable is  $t$ , so the variation of the compressed energy can only appear in the  $t$  variable portion. See Chapter 2.

52. (a) James Patterson, U.S. Patents 5,318,675; 5,372,688; 5,607,563  
(b) — and Dennis Cravens, U.S. Patent No. 5,607,563.

53. Ironically, as suppression of innovative research in science increases, science may eventually face turning into the kind of dogmatic system that it struggled against for some 300 years before escaping. When science defends a theory that experiments refute, as it does today in the case of cold fusion, then it is very close to that debacle that can spell the end of science itself.

54. E. Allan Blair, Letter to the Editor, *Newsweek*, Mar. 3, 1997, p. 14.

55. Arthur C. Clarke, "Space Drive: A Fantasy That Could Become Reality," *NSS... AD ASTRA*, Nov/Dec 1994, p. 38.

56. William K. George, in *Editing the Refereed Scientific Journal*, edited by Robert A. Weeks and Donald L. Kinser, IEEE Press, New York, 1994. p. 227-228.

57. Max Planck, in G. Holton, *Thematic Origins of Scientific Thought*, Harvard University Press, Cambridge, MA, 1973.

58. Jonathan Schlefer, editor of *Technology Review*, published at MIT. in an October 1990 editorial.

59. Rolf Landauer, "Fashions in Science and Technology," *Physics Today*, 50(12), Dec. 1997, p. 62.

60. Julius Robert Von Mayer, "Bemerkungen iiber die Krafte der unbelebten Natur," in J. von Liebig's *Annalen der Chemie* (vol. 42), 1842; *Die organische Bewegung in ihrem Zusammenhange mit dem Stoffwechsel*, (Organic Motion in Its Relation to Metabolism), 1845. His papers were published as *Die Mechanik der Warme*, 1867, with third edition in 1893.

61. Alfred Wegener, *Die Entstehung der Kontinente und Ozeane*, 1915; fourth revised edition, 1929. A Dover reprint of the fourth revised edition, translated into English, *Origin of Continents and Oceans*, was published in 1996.

62. Paul Nahin, *Oliver Heaviside: Sage in Solitude*, IEEE Press. New York, 1988, p. 225.

63. Martin Gumpert, *Trail-Blazers of Science*. New York, Funk and Wagnalls Company, 1936, p. 232.

64. This area is now referred to as *ovonics*, where the "ov" is directly taken from "Ovshinsky". The materials have found use in copy machines, fax machines, liquid crystal displays, and optical memory disks.

Ovshinsky has obtained over 200 patents and continues to work in the energy conversion field. His development of a new storage battery, e.g., broke all the Department of Energy tests and doubled the energy density permitted. Once in awhile the good guys beat the scientific suppression system.

65. Stan and Iris Ovshinsky were honored with the American Chemical Society's Heroes of Chemistry Award for 2000. They were honored for 40 years of sustained effort and contributions in the

sustainable and renewable energy field, including amorphous silicon cells for roofs of houses, highly specialized storage batteries, etc.

66. On the other hand, many scientific disagreements are conducted in quite proper and gentlemanly fashion. An example is the continuing decades of argument over energy flow theory, in *Am. J. Phys.* The problem has still not been officially resolved; we would hope that the material in this book will shed new light upon it, by pointing out the exact difference between the long-neglected nondiverged component as well as the diverged component, and also pointing out what Lorentz's trick of closed surface integration of the energy flow vector really does.

67. It follows quite naturally that, once we compress spatial energy by  $c$ , we may place the compressed energy in 3-space, in which case it is known as "mass", or we may place it in the time domain, in which case it is known as "time". If that cannot be done, then physics errs in using time as a variable on the fourth axis, and fundamental units are not arbitrary after all.

68. E.g., see D. K. Sen, *Fields and/or Particles*, Academic Press, London and New York, 1968, p. viii. Quoting: "*The connection between the field and its source has always been and still is the most difficult problem in classical and quantum electrodynamics.*"

69. See T. D. Lee, "Can Time Be a Discrete Dynamical Variable?". *Phys. Lett*, 122B(3, 4), Mar. 10, 1983, p. 217-220. Lee showed that time is a discrete dynamical variable across the entire range of mechanics: from classical to nonrelativistic quantum mechanics, and then to relativistic quantum field theories. In all stages of mechanics, time can be treated as a discrete parameter, and it can be treated as a bona fide dynamic variable, Hence time has dynamics and structure, and therefore energy.

70. E.g., one may assume that the entire virtual state is an internal structuring and dynamics existing inside the macroscopic flow of time. The virtual state dynamics obviously exists in spacetime (which is assumed to be continuous), but we also consider any "virtual particle" (e.g., a virtual electron) as if it had been suddenly "observed" momentarily. That assumes  $d/dt$  (LLLt)  $\Rightarrow$  LLL, a frozen 3-space snapshot. However, since that cannot really be observed, then we are actually considering something analogous to "if we could observe something in spacetime that cannot be observed in space alone". The only place left for it to

!observably exist anyway, if we could in fact observe it" is time, if space is ruled out.

71. It is necessary to trace the energy transductions and dissipations inside the generator. Ignoring those internal dynamics, the casual observer sees that one inputs shaft energy to the generator, and out comes some electromagnetic energy in the external electrical circuit, pouring from the generator terminals. We catch a lesser amount out there in the external circuit or power line, so we think we input some energy, had some internal losses and what gets collected in the conductors of the power line is the remainder of what we input, after transductions and losses in the generator. That is not what happens at all! Embarrassingly, an *enormous* flow of energy comes out of those generator terminals, if all of it is accounted.

This includes (i) the tiny component that strikes the surface charges of the external conductors and gets diverged into the conductors, thus being captured by the circuit, and (ii) the enormous remainder of the energy flow in the surrounding space, which misses the circuit altogether and is just wasted. Something like a trillion times as much EM energy may be pouring out of the terminals of the generator and *being wasted*, as we mechanically input to the generator shaft, or as we "catch" and use in the external circuit. As later chapters discuss, Poyntin ; never considered the component that misses the circuit entirely. Heaviside discovered it but could not explain its startling magnitude or its source. Lorentz knew of this enormous flow component. He could not explain it, and stated it "had no physical significance" since it powered nothing. Lorentz originated a little integration trick that discarded it neatly from all accountability.

72. If the energy input to an inert power system generator were what powered the attached external circuit, then only the Poynting component would be emitted from the terminals of the generator. In that case, Heaviside's discovery of the additional nondiverged component would be wrong, and Lorentz was also wrong in recognizing it by stating it had no *physical* significance. It also means that a dipole formed between the terminals can have no broken symmetry in its active vacuum flux exchange, which is falsified by particle physics {14, 73,}. Also, no charge could pour out energy and create fields and potentials in surrounding space, and neither could a dipole. That is easily falsified by actual experimental measurement. Our reinterpretation of Whittaker's wave decomposition of the scalar potential would also be wrong, as would Mandl's and Shaw's argument {19} that a combined pairing of a scalar

photon and a longitudinal photon are observable, producing the instantaneous scalar potential.

73. T. D. Lee, *Particle Physics and Introduction to Field Theory*, Harwood, New York, 1981, *passim*. In 1957, Lee and Yang received the Nobel Prize for their work in predicting broken symmetry. This included the broken symmetry of opposite charges — and hence of a dipole.

The very definition of broken symmetry, applied to the source dipole once it is formed in the generator, reveals that the dipole itself receives virtual photon energy from the seething vacuum, transduces it, and outputs it as real observable EM energy pouring out of the generator terminals and out through 3-space surrounding the entire power line. This is the source of the tremendous energy flow from the terminals, including a large component missing the circuit (as discovered by Heaviside in the 1880s). This large nondiverged component of the energy flow was discarded arbitrarily by Lorentz because there was absolutely no explanation of its source, and because it was thought to have "no physical significance" (Lorentz's term) since it powered nothing.

74. Wu et al. {14} experimentally showed that the weak interaction violates parity (spatial reflection) and thus exhibits broken symmetry.

75. T. D. Lee is noted for his broken symmetry work with charges, and for establishing the broken symmetry of separated charges of unlike sign. In 1957, Lee and Yang were awarded the Nobel Prize in Physics for their investigations of weak interactions between elementary particles.

76. John D. Kraus, *Electromagnetics*, Fourth Edition, McGraw-Hill, New York, 1992, p. 578.

77. We strongly feel that anyone interested in logic must read Morris Kline, *Mathematics: The Loss of Certainty*, Oxford University Press, New York, 1980. Contrary to popular opinion and the impression projected by mathematicians, mathematics is not a body of unshakable truths about the physical world, and mathematical reasoning is not exact and fallible.

78. One also needs to be aware of Godel's proof. See Kurt Godel, "Uber formal unentscheidbare Satze der *Principia Mathematica* und verwandter Systeme" ("On Formally Indeterminable Propositions of the *Principia Mathematica* and Related Systems," in *Monatshefte fur Mathematik und Physik*, Vol. 38, 1931. This is the publication in which Godel's Proof first appeared, which states that within any logical



mathematical system there are propositions or questions that cannot be proved or disproved on the basis of the axioms within that system. Therefore, it is uncertain whether or not the axioms or arithmetic will give rise to contradictions, since they can.

79. A critical reference for the longitudinal EM interferometry weapons is M. W. Evans, P. K. Anastovski, T. E. Bearden *et al.*, "On Whittaker's Representation of the Electromagnetic Entity in Vacuo, Part V: The Production of Transverse Fields and Energy by Scalar Interferometry," *J. New Energy*, 4(3), Winter, 1999, p. 76-78. This paper is a short but rigorous proof of a scalar interferometer's ability to produce EM fields and energy in the distant interference zone. Either diverging (heating) energy or converging (cooling) energy — in the normal sense, extraction of energy — can be created in a distant interference zone. By pulsing and controlling the circuit ground bias of the transmitters, one produced distant hot explosions or cold explosions. In a military target in that distant zone, the effects arise from the local spacetime, thus from everywhere within the targeted vehicle. At least eight nations now have such weapons, which were apparently the weapons that Defense Secretary Cohen {89} referred to in 1997.

80. Jackson {22}, p. 249.

81. Bunge, {3}, p. 182.

82. Roger Penrose, "Foreword," in T. W. Barrett and D. M. Grimes [Eds.], *Advanced Electromagnetism: Foundations, Theory, & Applications*, World Scientific, (Singapore, New Jersey, London, and Hong Kong), 1995.

83. Myron Evans, President of Alpha Institute's Institute for Advanced Study, private communication, 1999. Dr. Evans is the author of over 600 scientific papers, the prestigious editor of several scientific book series, and a noted foundations scientist. He is the co-discoverer and proponent of the Vigier-Evans B(3) magnetic field and a proponent of the proposed fundamental extension of U(1) electrodynamics to O(3) electrodynamics. O(3) electrodynamics has now been revealed as an important subset of Sachs' unified field theory.

84. Robert H. Romer, "Heat is not a noun," *Am. J. Phys.*, 69(2), Feb. 2001, p. 107-109. The quotation is from footnote 24, p. 109.

85. E. T. Whittaker, "On the Partial Differential Equations of Mathematical Physics," *Math. Ann.*, Vol. 57, 1903, p. 333-355.

86. But see Chapter 2 for a reinterpretation and correction of Whittaker's decomposition of the scalar potential. His harmonic set of bidirectional phase conjugate longitudinal EM wavepairs in 3-space is replaced with a harmonic half-set of longitudinal EM waves converging in the time domain upon the dipolarity; absorption and transduction by the charges; and re-emission as the other harmonic half-set of longitudinal EM waves diverging out from the source dipolarity in all directions in 3-space. The correction allows a very novel solution to the long-vexing problem of the source charge and its associated fields and potentials and their energy {12}.

87. (a) G. Johnstone Stoney, "Microscopic Vision," *Phil. Mag.*, Vol 42, Oct. 1896, p. 332; (b) — "On the Generality of a New Theorem," *Ibid.*, Vol.43, 1897, p. 139-142; (c) — Discussion of a New Theorem in Wave Propagation," *ibid.*, Vol. 43, 1897, p. 273-280; (d) — "On a Supposed Proof of a Theorem in Wave-motion," *ibid.*, Vol. 43, 1897, p. 368-373.

88. Some Russian scientists refer to the hidden internal electrostatics as the "information content of the field".

89. Secretary of Defense William Cohen at an April 1997 counterterrorism conference sponsored by former Senator Sam Nunn. Quoted from DoD News Briefing, Secretary of Defense William S. Cohen, Q&A at the Conference on Terrorism, Weapons of Mass Destruction, and U.S. Strategy, University of Georgia, Athens, Apr. 28, 1997.

90. For a basic discussion of these photon polarizations, see (a) Richard Feynman, *Quantum Electrodynamics*, 1961, 1963. Quantum field theory recognizes four polarizations of the photon, to include x- and y-transverse polarizations in 3-space, longitudinal or z- polarization in 3-space, and the time-polarized photon (which may be taken to be a longitudinally-polarized photon in the time axis). Existence of these four modes of polarization or energy vibration in photons implies the existence of four correspondingly polarized EM waves. Among other things, Feynman discusses the "sum over four polarizations" of photons and such. The term "Gupta-Bleuler" theory is the formalism that has grown up around this problem. For a deeper discussion, see (b) Lewis H. Ryder, *Quantum Field Theory*, Second Edition, Cambridge University Press, 1996, p. 147 *et seq.* For an even more advanced discussion, see (c) F.

Mandl and G. Shaw {19}. For discovery of the coupling of time-polarized and 3-space longitudinally polarized EM waves as the higher EM energy flow symmetry resolving the source charge problem, and thereby reinterpreting Whittaker's decomposition of the scalar potential {85}, see (d) Bearden {12}. We point out that the latter reinterpretation can also be "cranked through" the superpotential theory of Whittaker, to involve all EM potentials, fields, and waves.

91. (a) E. T. Whittaker, "On an Expression of the Electromagnetic Field Due to Electrons by Means of Two Scalar Potential Functions," *Proc Lond. Math. Soc.*, Series 2, Vol. 1, 1904, p. 367-372. The paper initiated what today is called *superpotential* theory. It was published in 1904 and orally delivered in 1903. For a sampling of other superpotential work, see (b) W. H. McCrea, *Proc. Roy. Soc. Lond. A*, Vol. 240, 1957, p. 447; (c) A. Nisbet, *Physica*, Vol. 21, 1955, p. 99; (d) P. Debye, *Ann. Phys., Leipzig*, Vol. 30, 1909, p. 57. For an excellent overview discussion of superpotentials and related things, see (e) Melba Phillips, "Classical Electrodynamics," in *Principles of Electrodynamics and Relativity*, Vol. IV of *Encyclopedia of Physics*, edited by S. Flugge, Springer-Verlag, 1962.

92. (a) See Evans et al. {79} for proof that scalar interferometry can produce all normal transverse EM fields, waves, and patterns. The paper appears in (b) P. K. Anastasovski; T. E. Bearden, C. Ciubotariu, W. T. Coffey, L. B. Crowell, G. J. Evans, Myron W. Evans, R. Flower, S. Jeffers, A. Labounsky, B. Lehnert, M. Meszaros, P. R. Molnar, J.-P. Vigier, and S. Roy, "The New Maxwell Electrodynamical Equations: New Tools for New Technologies," *J. New Energy*, 4(3), Special Issue of AIAS papers. Winter 1999. The volume consists of some 60 papers by the Alpha Foundation's Institute for Advanced Study (AIAS), advancing electrodynamic theory to a non-Abelian, gauge theoretic higher topology theory in  $O(3)$  internal symmetry. Some ten of the papers directly address Whittaker's work and extend it.

93. (a) W. A. Rodrigues, Jr. and J.-Y. Lu, "On the existence of undistorted progressive waves (UPWs) of arbitrary speeds  $0 < v < \infty$  in nature," *Found. Phys.*, 27(3), 1997, p. 435-508 show that Maxwell's equations do possess superluminal solutions. A slightly corrected version is downloadable as hep-th/9606171 on the Los Alamos National Laboratory web site. Also see (b) W. A. Rodrigues, Jr. and J. Vaz Jr., "Subluminal and Superluminal Solutions in Vacuum of the Maxwell

Equations and the Massless Dirac Equation," *Adv. Appl. Clifford Algebras*, Vol. 7(S), 1997, p. 457-466.

In classified Russian weapons labs, this internal longitudinal wave (both time-domain and 3-space domain) structuring of all normal (transverse) EM potentials, fields, and waves is euphemistically called the *information content of the field*. For decades there has been a successful disinformation campaign to lead scientists of other countries into believing that the phrase means *standard spectral analysis*. It doesn't. It is also possible to communicate at superluminal speed, using longitudinal EM waves inside this infolded "inner" electrodynamics. Since mass is mostly empty space filled with a particle here and there — together with EM potentials, fields, and waves — then mass is a vast "superhighway" for direct superluminal communication using longitudinal EM waves.

94. Romer, {84}.

95. See E. T. Whittaker, *A History of the Theories of the Aether and Electricity*, two vols., Nelson, London, 1951, 1953. Reprinted by Dover.

96. Note that we have just resolved the age-old problem of change, which can be summarized in the query stated so long ago by Heraclitus: "For a thing to change, it must turn into something else. But how can a thing be itself and something else also?" We have explained the enigma by pointing out that the "thing" has no persistence in time, and is continually changing into yet another thing, either a replica (in which case we sense "no change" and hence "persistence" by memory comparison), or a partial replica with some differences (in which case we sense that "the object has changed itself in some way"), or a thing with little or no replication (in which case we sense a "different thing"). It is the unseen nature of the  $d/dt$  observation process that has deluded us into such irresolvable logical conflicts — and into an incomplete Aristotelian logic based on observation alone, which does not contain the resolutions to such problems because a higher-order logic is required.

97. Whittaker, {85}

98. See Chapter 2 for a discussion of the substitution of effect for cause, and of the nature of observation.

99. *Wu et al.*, {14}.

100. Sen, {68}.

101. Also see Mandl and Shaw {19}.

102. William G. Harter, John Evans, Roberto Vega, and Sanford Wilson, "Galloping waves and their relativistic properties," *Am. J. Phys.*, 53(7), July 1985, p. 671-679. A relativistic example is given in which the source frame observes a very nonuniformly-galloping wave whose velocity varies between  $0.01 c$  and  $100 c$ , even though its average velocity is  $c$ . Relativistic properties of interfering electromagnetic plane waves are discussed.

103. We point out, but do not further pursue, that this situation is reversed when time is reversed. This has very interesting applications in our little "time reversal zones" that we found were so important in the electrolyte experiments of the cold fusion researchers, and which accounted for a new class of nuclear interactions previously unknown. This does reverse the conventional law of attraction and repulsion of charged particles. It also directly affects the quarks and gluons, partially or even nearly dissolving the gluon forces holding the quarks in place, so that the quarks are nearly freed and are easily flipped.

104. Simultaneously accompanied by *separately broken* time-energy flow symmetry and *separately broken* 3-spatial energy flow symmetry.

105. Evans et al., {38b, 38c}.

106. Oliver Heaviside, *Electrical Papers*, Vol. 2, 1887, p. 94.

107. Kraus, {76}.

107. E.g., see (a) Jackson {22}, p. 237. Jackson points out that "...the Poynting vector is arbitrary to the extent that the curl of any vector field can be added to it. Such an added term can, however, have no physical consequences." The first sentence is true, but the second sentence is a non sequitur. Poynting only considered the small component of the overall energy flow that enters the circuit — in short, that strikes the surface charges in the conductors and is diverged into the wires to power the Drude electrons. That is the diverged part of the energy flow. All the rest of the flow that misses the circuit is obviously not diverged or collected in the circuit, and so it has zero divergence. It is elementary vector algebra that the curl of any vector field has zero divergence. So the extra nondiverged Heaviside energy flow component — filling all space around the conductors in a power line, e.g., but missing the power system entirely and just wasted — can indeed be expressed as the curl of a vector field. That energy flow is real, however, and if intercepted and collected, it then does become divergent. In that case, it does have highly significant

consequences, since the total energy flow in that component may be a trillion times the energy flow in the Poynting component alone.

For a rigorous experiment demonstrating the reality and significance of that "physically insignificant energy flow" that "can have no physical consequences", see (b) Bohren {24}. Under nonlinear conditions, a particle can absorb more energy than is in the light incident on it by normal calculations. Electrodynamacists do *not* calculate the magnitude of an entire field or potential, e.g., but only the intensity of a *divergence from* it at a single point, as given by an intercepting unit point static charge. If that same charged particle is placed in particle resonance, it sweeps out a greater geometrical reaction cross section. Hence it intercepts and **collects** (diverges) more impinging energy — from that long-neglected otherwise nondiverged component of the flow or field that is not diverged by the *static* unit point charge assumed conventionally. Metallic particles at ultraviolet frequencies are one class of such particles and insulating particles at infrared frequencies are another. See also (c) Paul and Fischer, {25}, who replicated Bohren's experiment.

109. H. A. Lorentz, *Vorlesungen über Theoretische Physik an der Universität Leiden*, Vol. V, *Die Maxwell'sche Theorie (1900-1902)*, Akademische Verlagsgesellschaft M.B.H., Leipzig, 1931, "Die Energie im elektromagnetischen Feld," p. 179-186. The section is called "Der Poyntingsche Energiestrom," and begins on p. 183. See his Figure 25 on p. 185.

110. E.g., see W. K. H. Panofsky and M. Phillips, *Classical Electricity and Magnetism*, Addison-Wesley, Reading, MA, 1962, 2nd edition, p. 181,

111. Bearden, {12}.

112. A simple way to see this is to note that the back-potential across the half-loop internal to the dipole is precisely equal to the forward potential externally between the ends of the dipole but across the **external** circuit half-loop. Since the same current  $q$  runs through both these potentials, then by  $Vq$  the same amount of energy is dissipated upon **the** charges of the dipole — to scatter them and destroy the dipole — as is dissipated in the external circuit in its losses and the load. Thus **more** energy is used to destroy the dipole than is used to power the load. We have to input at least as much shaft energy to restore the dipole as was used to destroy it. Hence the  $COP < 1.0$ .

113. See to (a) M. W. Evans, P. K. Anastasovski, T. E. Bearden *et al*, "Classical Electrodynamics without the Lorentz Condition: Extracting Energy from the Vacuum," *Physica Scripta*, 61 (5). May 2000, p. 513-5 17 in addition to that paper previously quoted. See also (b) "Runaway Solutions of the Lehnert Equations: The Possibility of Extracting Energy from the Vacuum," *Optik*, 111(9), 2000, p. 407-409.

114. Robert Bruce Lindsay and Henry Margenau, *Foundations of Physics*, Dover, New York, 1963, p. 25.

115. *Ibid.*, p. 213.

116. *Ibid.*, p. 217.

117. M. Faraday, *Experimental Researches in Electricity and Magnetism*, Vol. 1, Taylor and Francis, London, 1839, Vol. 2, Richard & John E. Taylor, London, 1844; Vol. 3, Taylor and Francis, London, 1855. A 1965 reprint of all three volumes is available from Dover, New York.

118. We also acknowledge the independent contributions of Joseph Henry. In 1830, Henry independently discovered magnetic induction, anticipating Faraday's own discovery of it. Faraday, however, published first. Two years later, Henry discovered self-induction. He died in 1878, and the unit of inductance, the *henry*, was named for him in 1893.

119. (a) Maxwell, {20}. Also see (b) James Clerk Maxwell, *A Treatise on Electricity and Magnetism*, Oxford University Press, Oxford, 1873, Third Edition, Volumes 1 and 2, unabridged, Dover Publications, New York, 1954. This standard citation widely used in the literature is in fact confusing; the First Edition was published in 1873, a second rather substantially altered edition was later published after Maxwell's 1879 death of stomach cancer, and a third edition, slightly altered from the second edition, was published even later. So controversial were quaternions at the publication of Maxwell's first edition in 1873, that part of what was to become the second edition — published after Maxwell's 1879 death — was truncated by Maxwell himself prior to his death and prior to the posthumous publication of the second edition. Thus there is considerable difference between the first and second editions, and first and third editions, of Maxwell's *Treatise*, compared to his original 1865 paper {20}. "Maxwell's theory" is actually his 1865 paper; everything else is a later truncation of Maxwell's theory.

120. Maxwell's letter to P. G. Tait in 1871, *Archives*, Cavendish Laboratory, Cambridge.
121. For a discussion, see (a) A. M. Bork, "Vectors versus quaternions - the letters in *Nature*," in *Am. J. Phys.*, Vol. 34, Mar. 1966, p. 202-211. For a cogent presentation of what might have been discovered much earlier in physics if quaternions had not been cast aside in favor of the much more limited vectors, see (b) James D. Edmonds Jr., "Quaternion quantum theory: New physics or number mysticism?", *Am. J. Phys.*, 42(3), Mar. 1974, p. 220-223.
122. Edmonds, {121b}. Edmonds presents a cogent argument showing the significant impedance of the rate of discovery in physics, that **resulted** from the ill-advised casting aside of the far more comprehensive quaternion theory in favor of the much more limited vector theory.
123. Heaviside, {5a, 5b}.
124. T. W. Barrett, "Tesla's Nonlinear Oscillator-Shuttle-Circuit (OSC) Theory," *Annales de la Fondation Louis de Broglie*, 16(1), 1991, p. 23-41, Barrett later extended some of the energy-shuttling techniques shown by Tesla and obtained U.S. Patents 5,486,833 and 5,493,691.
125. (a) A. A. Michelson and E. W. Morley, "Influence of motion of the medium on the velocity of light," *Am. J. Sci.*, Vol. 31, Series 3, 1886, p. 377-386; (b) — "The relative motion of the earth and the luminiferous aether," *Am. J. Sci.*, 34(3), 1887, p. 333; (c) — "On the relative motion of the earth and the luminiferous aether," *Phil. Mag.* 24(4), 1887, p. 449. See also (d) A. A. Michelson, "The relative motion of the earth and the ether," *Am. J. Sci.*, (4), 3, 1897, p. 475.
126. (a) Mendel Sachs, *General Relativity and Matter: A Spinor Field Theory from Fermis to Light-Years (Fundamental Theories of Physics)*, Reidel, 1982. Sachs provides a great generalization of general relativity and electrodynamics reaching from the quarks and gluons to the entire universe. See also (b) Mendel Sachs, "Symmetry in Electrodynamics: From Special to General Relativity, Macro to Quantum Domains," in M. W. Evans, Editor, *Modern Nonlinear Optics*, Second Edition, Wiley, New York, 2001, Part 1, p. 677-706.
127. Myron W. Evans, Director of the Alpha Foundation's Institute for Advanced Study, private communication, 2001.
128. Jackson, {22}, p. 249.



129. Jackson, {22}, p. 28.

130. Feynman, {7}, Vol. 1, p. 2-4.

131. Physicists often speak of spacetime as "space", since in Minkowski geometry the time portion is modeled along a separate spatial axis used in addition to the ordinary three spatial axes. So Feynman's "distortion" is actually Riemannian spacetime curvature.

132. As an aside, note that Feynman also utilized a dipolarity. There is always a scalar potential between the poles of any dipole. Further, this "dipole potential" decomposes according to Whittaker's 1903 decomposition {85}, as re-interpreted by Bearden's giant negentropy approach {12} in 2000, and as relates to Mandl and Shaw's 1984/1993 argument {19} that only the associated time-polarized photon and longitudinal photon together are observable, and then as the instantaneous scalar potential. If we accept Mandl and Shaw's powerful argument, then the Whittaker 1903 decomposition must be reinterpreted to be in accordance. That is what was done by the present author {12} to resolve the source charge problem as well as the source dipole problem. In addition, the resolution must be in accord with the theoretical and experimental findings of particle physics, to include the broken symmetry of the opposite charges on the ends of a dipole. The giant negentropy process uncovered by Bearden {12} fulfills all the necessary requirements. It also places the theme of this book — *Energy from the Vacuum: Concepts and Principles* — on a solid theoretical and experimental basis.

133. Feynman, {7}, vol. II, p. 1-3.

134. Jackson, {22}, p. 811-812.

135. We have previously postulated this feature where one second is equal to spatial EM energy compressed by the factor  $c^2$ , so that time is just extremely compressed EM spatial energy. See Bearden, {17}.

136. (a) Harter et al., {102}. It may well be that galloping due to time-density variation may provide an alternative explanation to quantum tunneling, which can readily occur at superluminal speed. E.g., see (b) A Enders and G. Nimtz, *Phys. Rev. Lett.*, Vol. 48, 1993, p. 632. Their superluminal tunneling experiments transmitted 8.7 GHz microwaves (free space wavelength 3.4 cm) traveling in a rectangular waveguide that contains a "barrier" section of reduced dimensions. Mozart's 40th Symphony was transmitted through the barrier waveguide as frequency

modulated microwaves, at an FTL group velocity of  $4.7c$ , receiving audibly recognizable music from the microwave photons that survived their barrier passage.

137. (a) M. W. Evans, "The Link Between the Sachs and  $0(3)$  Theories of Electrodynamics," in M. W. Evans, editor, *Modern Nonlinear Optics*, Second Edition, Wiley, New York, 2001, Part 2, p. 469-494; (b) — " $0(3)$  Electrodynamics," in M. W. Evans, editor, *Modern Nonlinear Optics*, Second Edition, Wiley, New York, 2001, Part 2, p. 79-267.

138. E.g., Ryder, {90b}, p. 147 *et seq.*

139. Rodrigues and Lu, {93a}.

140. Rodrigues and Vaz, {93b}.

141. The reader should recall that to this day there is no satisfactory resolution of the wave-particle duality principle. Physicists finally just shook hands and agreed to quit fighting, since the hullabaloo was getting them nowhere. The problem does have a probable resolution, but not in Aristotelian logic.

142. Bearden, {12} discusses the relation between time-energy and 3-spatial energy, and reveals a more fundamental 4-symmetry between time energy flow and spatial energy flow. In this 4-symmetry EM flow, time symmetry in energy flow is broken and simultaneously 3-space symmetry in energy flow is broken, but 4-symmetry in energy flow is maintained. The basic transduction of time-energy into 3-space energy and vice versa is accomplished by the interacting charge.

143. Bearden, {15}, p. 11. In the paper we also gave a force-free definition of mass, in terms of the transduction of angular momentum across the 3-spatial boundaries of a mass particle.

144. Rigorously, *mass* does not and cannot emit a photon; *masstime* does. But an observable mass  $m$  can be absorbing and emitting **enormous** numbers of virtual photons while not yet having absorbed another observable photon and decayed to emit an observable photons. Differential (virtual) pieces of a "frozen" observable mass  $m$  are **indeed** changing continually into masstime and back into mass, by absorbing and emitting virtual photons per equation [14b], while the observable mass  $m$  has not yet completed its absorption and emission of an observable **photon**. This "knitting" together of observable and virtual state interactions is one of the great centralizing features of physics.

145. The problem is due to the hoary old erroneous notion in mechanics that a separate force acts upon a separate mass to move it.
146. There appears to be no paper or textbook which calculates the actual "energy magnitude" of an entire potential or an entire field, including over all space occupied by it. All texts advance the "local intensity" indicator calculation, and then call that the "magnitude of the potential". That is a non sequitur of first rank. A skilled electrodynamicist will call it the intensity of the potential.
147. It appears that the only region where this statement is in dispute is in various models attempting to explain the creation of the universe. Since that is *a priori* a creation event, then physicists struggle with explaining how something (the existing universe) was created out of nothing (the absence of any slightest bit of the existing universe). We will leave that debate to the astrophysicists and cosmologists. The "accursed identity of opposites" has been the bane of philosophers for more than 3,000 years.
- 148.** Ibrahim Semiz, "Black hole as the ultimate energy source," *Am. J. Phys.*, 63(2), Feb. 1995, p. 151.
149. David Halliday and Robert Resnick, *Fundamentals of Physics*, Third Edition Extended, Wiley, New York, 1988, Vol. 1, p. 518.
- 150.** Stanley W. Angrist, "Perpetual Motion Machines," *Sci. Am.*, Vol. 218, Jan. 1968, p. 114-122.
- 151.** Stanley W. Angrist, "Perpetual Motion," *Encyclopaedia Britannica*, Bicentennial Edition, Macropaedia Vol. 14, 1976, p. 102-105.
- 152.** Lindsay and Margenau, {114}, p. 217.
- 153.** Heaviside, {106}, p. 94.
154. Kraus, {76}, Figure 12-59, p. 578.
155. Bohren, {24}.
- 156** Paul and Fischer, {25}.
- 157.** (a) V. S. Letokhov, "Laser Maxwell's Demon," *Contemp. Phys.*, 36(4), 1995, p. 235-243; (b) — "Generation of light by a scattering medium with negative resonance absorption," *Zh. Eksp. Teor. Fiz.*, Vol. 53. 1967, p. 1442 (English translation is in *Sov. Phys. JETP*, 26(4), Apr. 1968. p. 835-839); (c) "Stimulated emission of an ensemble of scattering particles with negative absorption," *ZhETF Plasma*, 5(8), Apr.

15, 1967, p. 262-265; (d) — "Double y - and optical resonance," *Phys. Lett. A*, Vol. 43, 1973, p. 179-180.

158. It is Heaviside's equations that are usually taught in University as "Maxwell's Equations," and labeled as Maxwell's equations in most undergraduate texts. In addition to Heaviside's work, similar changes were made by Gibbs in the United States and by Hertz in Europe. Every sophomore physics student and electrical engineering student should be given a short treatise on the background development of electrodynamics, and how, when, and by whom Maxwell's 20 quaternion equations were modified into the present four vector equations. The treatise should also point out what was omitted from Maxwell's theory in its truncations. It should be made very clear to every student that his elementary EM subject errs dramatically from physical reality when it assumes a flat local spacetime and an inert local vacuum. *By discarding the physically active environment of all Maxwellian systems*, only a highly limited subset of nature's electrodynamics is captured in the standard electrical engineering model. Specifically, systems far from equilibrium in their exchange with that environment are arbitrarily discarded. Those are precisely the Maxwellian systems permitted to exhibit coefficient of performance greater than unity. In short, the truncation of Maxwell's theory arbitrarily discarded all electrical windmills turning — or partially turning — in a free electrical wind.

159. As we pointed out, there are *tin electromagnetic systems at all* in that first class — and never have been — if we account for the arbitrarily-ignored Heaviside energy flow pouring from the source dipole and the energy flow pouring from every charge, and consider the situation prior to self-enforced implementation of Lorenz/Lorentz symmetrical regauging (by the closed current loop circuit). The remarks — pertaining to EM systems supposedly in equilibrium with the active vacuum — only apply if we neglect that Heaviside component and also neglect the source **charge** problem, and even then only if the circuit self-enforces that equilibrium in its exchange with the active vacuum. But since it has been so long **and** ubiquitously neglected, we will continue to speak of the "two classes" of EM systems from that "conventional" view. It is rather like our concession to electrical engineering, where the word "power" is universally **misused**. However, the reader should be aware of what we are doing and why.

160. See (a) Ilya Prigogine, *Nonequilibrium Statistical Mechanics*, Wiley-Interscience, New York, 1962; (b) — *From Being to **Becoming***:

*Time and Complexity in the Physical Sciences*, W. H. Freeman and Company, San Francisco, 1980; (c) D. Kondepudi and Ilya Prigogine, *Modern Thermodynamics: From Heat Engines to Dissipative Structures*, Wiley, Chichester, 1998; (d) G. Nicolis and I. Prigogine, *Self-Organization in Non-Equilibrium Systems: From Dissipative Structures to Order through Fluctuations*, Wiley, New York, 1977. For a good educated layperson's overview, see (e) Gregoire Nicolis, "Physics of far-from-equilibrium systems and self-organization," Chapter 11 in {f} Paul Davies, Ed., *The New Physics*, Cambridge University Press, Cambridge, 1989, p. 316-347.

161. Actually, Ludvig Valentin Lorenz first performed the equivalent of symmetrical regauging of Maxwell's equations, only two years after Maxwell's seminal paper was published in 1865. See (a) Ludvig Valentin Lorenz, "On the identity of the vibrations of light with electrical currents," *Phil. Mag.*, Vol. 34, 1867, p. 287-301. Not much attention was paid to Lorenz's work, however, and the later symmetrical regauging of the Maxwell-Heaviside equations by H. A. Lorentz is what "stuck" and came to be used. For a proper historical discussion, see (b) J. D. Jackson and L. B. Okun, "Historical roots of gauge invariance," *Rev. Mod. Phys.*, Vol. 73, July 2001, p. 663-680.

162. This point is important. See Gabriel Kron, "The Frustrating Search for a Geometrical Model of Electrodynamical Networks," circa 1962. General Electric publication, p. 11-128. Quoting p. 114: "...the missing concept of "open-paths" (the dual of "closed-paths") was discovered, in which currents could be made to flow in branches that lie between any set of **two** nodes. (Previously -following Maxwell - engineers tied all of their open-paths to a single datum-point, the 'ground'). That discovery of open-paths established a second rectangular transformation matrix... which created 'lamellar' currents... " "A network with the simultaneous presence of both closed and open paths was the answer to the author's years-long search."

When we design and build a circuit or system in compliance with the Lorenz/Lorentz-regauged equations, it follows that *the circuit itself must contain some feature and function that self-enforces the Lorenz/Lorentz condition — at least during the excitation discharge of the energy that has been freely caught by the circuit. The Lorenz/Lorentz condition is not a law of nature, nor is it automatically applied without a specific circuit cause and function physically applying it.* That function is automatically applied by the standard closed current loop circuit.

As Kron stated, his long search for a true negative resistance finally succeeded when he discovered the "open path". Actually Kron had discovered that any two points in the universe at different potentials (charged to different intensities) produced a flow of EM energy. In other words, he had discovered in more classical EM terms the broken symmetry of opposite charges of differing charges, such as on the ends of any dipole or across any dipolarity.

163. Superconducting *sections* in a system may be loss-free, but the entire superconducting *system* has losses and exhibits only  $COP < 1.0$  overall, if the refrigeration burden is accounted. In the superconducting section alone, without accounting for the cooling overhead, the  $COP = 1.0$  and the efficiency is 100% also.

164. After Jackson, {22}, p. 219-221; 811-812.

165. See Whittaker, {85}. Whittaker mathematically decomposes the scalar potential into a hidden "bidirectional" series of EM wavepairs in a harmonic sequence. Each wavepair consists of the wave and its phase conjugate. Thus any  $A_c$  (as across the terminals of a dipolar electrical power source) *a priori* involves an ordered, hidden, bidirectional EM wave flow. I.e.,  $d(fi)$  *identically is* such a hidden bidirectional EM energy flow.

166. But see Bearden, {12}. In the paper we conceptually re-interpreted Whittaker's 3-space (observation assumed, hence effect waves) bidirectional wavepairs. Our reinterpretation yields a correlated harmonic half-set of converging *unobserved* causal EM longitudinal waves (time-polarized EM waves) in the time domain prior to interaction with charge so as to prepare for being observed, and a harmonic half-set of diverging EM longitudinal waves (after observation due to the convergent time-polarized EM waves interacting with the observable charges) in 3-space in all directions. We strongly stress that observation does not occur without the absorption of a scalar photon and the follow-on emission of a longitudinal photon. In a time-reversed situation (phase conjugate charge condition), to the observer it appears to have happened in the other direction.

167. Particularly see Mandl and Shaw, {19}.

168. However, Mandl and Shaw fail to totally identify the "combining mechanism". They do not account the detailed interaction of the detecting/observing unit point charge, and thus fail to clearly account for the absorption of the incoming time-polarized wave or photon, the

transduction of that excitation energy of the charge into longitudinal EM wave/photon energy, and the subsequent emission of that excitation energy in 3-space in all directions as longitudinal EM waves/photons. So Mandl and Shaw do not clearly account for *photon (or wave) polarization transduction by the ubiquitously assumed charge*. The "causal" time-polarized EM wave or photon comes in and is absorbed by the detecting charge or dipole, then the absorbed energy is transduced and re-emitted in 3-space as the longitudinally polarized EM wave or photon in 3-space. (Actually, since all space is charged, what is really emitted into 3-space is the giant circulation of EM energy between time and 3-space, which is a more rigorous statement of what "propagation of EM energy through 3-space actually is). Recognition of these missing interactions and transductions allowed a solution at last to the long-vexing problem of the source charge, often called the greatest problem in both quantum and classical electrodynamics, as given initially in Bearden, {12}. Now, of course, a greater problem has reared its head: the notion that EM energy continuously propagates in 3-space is a total non sequitur, along the lines objected to by Romer {84}. We therefore have some very fundamental rethinking to do for all of classical physics. This is really where the problem of wave-particle duality has pointed since the beginning.

169. Asymmetrical self-regauging collects just a tiny bit more of the enormous energy that is flowing outside the conductors and usually wasted. E.g., if the self-regauging EM system collects as  $\mathbf{j}\phi$  some  $10^{-12}$  of the energy flow instead of the more usual  $10^{-13}$ , the system can have a COP =10, *if it* does not then expend half the collected energy to destroy the source dipole faster and require its reconstitution more energetically. And so on.

170. Jackson, {22}, p. 220-223.

171. So-called "canceling" opposing EM fields are actually produced, which sum to a *vector zero system* with respect to translation, which the electrodynamicists erroneously discard by assumption. We point out, but do not further pursue, that the locally produced *field energies* of the opposing fields in a zero-summed vector system remain and add, even though the fields offset each other *translationally*. The local energy of the field is proportional to the square of the local magnitude, and that is always positive regardless of field orientation. Thus "trapped" and structured EM stress energy has been localized in spacetime in the symmetrical regauging of CEM. This rigorously is a gravitational change

and therefore a local curvature of spacetime *a priori*. Indeed, the field energy remains in a zero-vector summation system, and has been changed into stress potential energy. It represents continuous internal work being performed on the system to stress it, by energy continuously fed in from the active vacuum environment but only in appositive fields of equal magnitude. The discarding of the zero vector summation system thus is a discarding of an available stress potential and its energy, a rotation of the system frame out of the laboratory frame, and a continuous exchange of energy from the vacuum that performs internal work upon the system but no external work in the load. The energy is not translational, but it is there nonetheless, and it causes a spacetime curvature change. The electrodynamicists have largely ignored the fact that gauge symmetry transformations are accompanied by local gravitational (spacetime curvature) changes that violate the prevailing flat local spacetime assumption of classical electrodynamics.

172. See (a) H. J. Josephs, "The Heaviside papers found at Paignton in 1957," *IEE Monograph No. 319*, Jan. 1959, p. 70-76. See also (b) E. R. Laithwaite, "Oliver Heaviside — Establishment Shaker," *Elec. Rev.*, 211(16), Nov. 12, 1982, p. 44-45. Heaviside became aware of this gravitational relationship, and worked out a draft theory of electrogravitation based on his energy-flow theory (which added nondiverged closed-loop circulations of energy which vectorially summed to net zero). Those "trapped EM energy flow loops" were *gravitational*, in Heaviside's concept. His hand-written notes on his electrogravitation theory were found long after his death, beneath the floorboards of his little garret apartment. In honor of Heaviside, we have nominated his huge nondiverged energy flow component — erroneously discarded by Lorentz — as the source of the extra gravity in the arms of the spiral galaxies, holding them together. In short, we have proposed that as the solution to the so-called "dark matter" problem.

173. Physicists love symmetry, turn to it at every opportunity, and will do almost any mathematical manipulation to obtain it, because they regard it as "beautiful." And so it is. Performing work, however, requires breaking symmetry to produce excess energy, which interacts with mass to produce a force, and then requires using that force to do the work. If we wish to build a system that produces more work output than the work that we ourselves have to do upon it to run it, then *a priori* that system must be *asymmetrical* and — to many physicists — *ugly*. Let us all drink a toast to more efficient *ugly* asymmetrical systems that also do not require **energy**.



input by the operator, but only by the active environment! Give us "ugly" electrical windmills that turn freely in electrical winds, rather than the inane "beautiful" present systems which destroy their energy winds faster than they power their loads.

174. While Lorentz appears to have done it earlier, one can see his use of the surface integration in (a) Lorentz, {109}. In 1896 he also included it, using a more general theorem by Volterra, so that Poynting's theorem arises as a special case; see (b) H. A. Lorentz, *Versl. K. Akad. W. Amsterdam*, Vol. 4, 1896, p. 176.

175. This is usually performed by the source dipole.

176. Thus the long and tedious effort of my colleagues and I to create circuits that asymmetrically self-regauge their potential difference (source voltage) without allowing all the spent load current to pass back through the primary power source dipole and do work upon it to scatter the charges and destroy its dipolarity.

177. Again we strongly stress that asymmetrically regauging a potential in the system also regauges the local vacuum potential and the intensity of the vacuum potential's bidirectional EM energy exchange with the system. It alters the local curvature of spacetime. It directly alters the stored **energy** of the system and of the supersystem. See again Whittaker, {85}, to see this clearly. See particularly our use of the *supersystem* concept in Chapter 8, and as mentioned in Chapter 1 and the present Chapter 2.

178. Circuits and electrical power systems universally and routinely break Lorentz symmetry for *excitation* (potentialization) of the system at the initial onset. Just to potentialize a system in theory costs nothing, although it freely changes the potential energy of the system. The gauge freedom axiom of quantum field theory also guarantees that such change of the potential energy of the system is essentially "for free". It conclusively proves that (i) asymmetrical self-regauging exists and is done in electrical circuits, since the source dipole in the power supply accomplishes that initial self-regauging of the external circuit completely for free once the dipole is made, and (ii) the Maxwell-Heaviside equations do permit asymmetrical self-regauging, in violation of Lorentz's arbitrary condition prohibiting it.

179. This is the patent-pending Bedini process, which is processing through the U.S. Patent Office as we go to press.

180. Lee, {73}, p. 184.
181. B. P. Kosyakov, "Radiation in electrodynamics and in Yang-Mills theory," *Soviet. Phys. Usp.*, 35(2), Feb. 1992, p. 135-142. Quotes are from p. 135 and p. 141. Our proposed solution to the problem posed by Kosyakov (which is actually the broken symmetry of a charge) is that negative charges pour out positive energy and positive charges absorb positive energy. We "see" the positive charge as pouring out "reversed direction positive field energy" after we interact the energy with a laboratory charge to "observe". Considering the well-known polarization of the vacuum by any charge, one realizes that a 4-symmetry circulation of the EM energy is what is "emitted" and spreads throughout all space, since the vacuum polarization is also spreading. The actual energy flow is between the time domain and 3-space and return, at any elemental dipole in the polarization of the vacuum that is spreading.
182. Oliver Heaviside, *Electrical Papers*, Vol. 2, 1887, p. 94.
183. Prof. William Keel, quoted in James McWilliams, "Through a Galaxy, Darkly," *Huntsville (Alabama) Times*, May 14, 2000, p. A-18.
184. Charles Seife, "Peering Backward to the Cosmos's Fiery Birth," *Science*, vol. 292, June 22, 2001, p. 2238.
185. M. P. Silverman, *And Yet It Moves: Strange Systems and Subtle Questions in Physics*, Cambridge University Press, Cambridge, 1993, p. 127.
186. Matthew Colless, Australian National University, one of the survey team leaders in the project leading the world in mapping galaxies, Mar. 2001.
187. (a) Lee, {13a}; (b) Lee, Oehme and Yang, {13b};
188. Wu et al., {14}.
189. Bearden, {12}.
190. Mandl and Shaw, {19, 168}.
191. Whittaker, {85}.
192. Gabriel Kron, "Invisible dual (n-1) networks induced by electric 1-networks," *IEEE Trans, on Circuit Theory*, CT-12(4), Dec. 1965, p. 464-470.

193. Kron, {162}. The quote is from p. 114.

194. Steven Weinberg, *Dreams of Final Theory*, Vintage Books, Random House, 1993, p. 109-110.

195. See Josephs, {172a}. Heaviside's hand-written notes contained his theory of electro-gravitation, based on his theory of energy flow. The papers were found beneath the floorboards in his little garret apartment.

196. Laithwaite, {172b}. Laithwaite feels that Heaviside's postulation that a flux of gravitational energy combines with the (ExH) electromagnetic energy flux, could shake the foundations of physics. Extracting from Laithwaite; "*Heaviside had originally written the energy flow as  $S = (ExH) + G$ , where  $G$  is a circuital flux. Poynting had only written  $S = (ExH)$ . Taking  $p$  to be the density of matter and  $e$  the intensity of a gravitational force, Heaviside found that the circuital flux  $G$  can be expressed as  $pu - ce$ , where  $u$  represents the velocity of  $p$  and  $c$  is a constant.*"

197. Hence the title of cited reference {12} above.

198. Melvin H. Miles and Benjamin F. Bush, "Radiation measurements at China Lake: Real or Artifacts?", *Proc ICCF-7 (International Conference on Cold Fusion — 7*, Vancouver, BC, Canada, Apr. 1998, p. 101.

199. Bearden, {17}.

200. See P. V. Elyutin, "The Quantum Chaos Problem," *Sov. Phys. Usp.* Vol. 31, No. 7, 1988, p. 597-622. Elyutin discusses the crisis in quantum mechanics because of the missing chaos (hidden order). Quantum mechanics is known to be wrong unless this order can be found, because otherwise it does not predict the ordered macroscopic universe. Thus any proposed solution to the quantum chaos problem is worthy of investigation, even if it turns out to be in error.

201. Unfortunately, entropy is one of those concepts in physics for which there are several differing major views. We consider entropy to be comparable to a positive resistor: organized energy goes in, disorganized energy comes out. Entropy is usually taken to be a measure of the disordering of energy. It does not *eliminate* the energy; it just makes it more difficult to *use* it. For our work in energy from the vacuum, we take the very simple view that a negentropic process is like a negative resistor: it receives energy in a form unusable to us, transforms it, and outputs it in

a form that is usable. In short, a negative resistor receives disordered energy and reorders it, so to speak. So it exhibits negentropy. We completely avoid the various notions of "information" and attempts to equate information and energy. We do point out, however, that a time-reversal process in one form or another is usually involved. In that sense, e.g., Newton's third law would be a negentropic process and involve time reversal in the mechanism generating the reaction-causing agent.

202. H. E. Puthoff, "Source of Vacuum Electromagnetic Zero-Point Energy," *Phys. Rev. A*, 40(9), Nov. 1, 1989, p. 4857-4862.

203. Whittaker, {91}. The paper was published in 1904 and orally delivered in 1903. This paper initiated superpotential theory.

204. As Whittaker showed in 1903, {85}, the scalar potential is actually a harmonic set of bidirectional EM longitudinal EM wavepairs, where each pair is composed of a longitudinal EM wave and its phase conjugate replica. Only because classical electrodynamicists have erroneously defined the field and potential as their own reaction cross sections with a unit point static charge, has the "static" potential been misidentified as a *scalar* entity, which it is not. The energy diverged from a uniform potential, around a fixed static point unit charge, is actually the set of divergences around the intercepting charge of the energy flows of all those EM waves comprising the potential. The sum total of all these individual wave divergences indeed has a scalar magnitude, but the magnitude of the total energy divergence from the potential is neither the potential itself nor its magnitude.

205. We point out the obvious: A "scalar" mass in 3-space actually **is** a time-vector since it moves through time continually, just to continue to exist. Further, it involves a special form of energy (energy compressed by  $c^2$ ) which time is taken to be. Since we may choose any form of energy we wish by simple transduction, we may take it as compressed EM energy. So the mere continued existence of any mass proves conclusively that EM energy can and does ubiquitously flow to, from, and through the time dimension. The combined continued existence of numerous masses **proves** conclusively that the flow of time can have a myriad internal electromagnetic energy flows. An equilibrium between (i) an inflow of EM energy to a transducer from the time dimension, and (ii) an **outflow of** EM energy in 3-space from the transducer, will be seen as a discrete excitation (potential energy) associated with the transducer. Hence **the** notion of the charge. Every charge in the universe may be said to pour out

energy (negative charge pours out positive energy; positive charge absorbs positive energy — the equivalent of pouring out negative energy — and any charge results in a polarization of the vacuum. Hence what we call "spacetime" or "vacuum" is in fact a giant circulation of energy from the time domain to 3-space, and back to the time-domain. In short, a giant negentropy process continually sustains the active universe and all its components and processes.

206. Evans et al., {79}.

207. Semiz, {148}.

208. Weinberg, {194}, p. 286.

209. The available internal energy of a generator is the transduced shaft energy we input to it, say by turning the generator shaft with a steam turbine or hydro turbine. The shaft mechanical energy input is transduced into internal magnetic field energy once the rotor rotates. This internal magnetic energy is then dissipated on the internal charges inside the generator, forcing the positive charges in one direction and the negative charges in the other, thereby making the source dipole between the **terminals** of the generator. The available internal energy of a battery is the chemical energy possessed by it at any given time, and available for performing work on the internal charges to force them apart to form a dipole between the plates (and the battery terminals).

210. Kraus, {76}. Figure 12-60, a and b, p. 578 shows a good drawing of the Poynting (intercepted) energy flow being withdrawn into the conductors from the surrounding space. It does not show the Heaviside nondiverged component remaining, which is even larger, not diverged into the conductors, and wasted. The reason for the remaining Heaviside non-diverged component is that the electrons precess laterally across the conductor, thus withdrawing into the conductor only a small nearby section of the fields of the surface electrons — the ones (plus their fields extending into space) which intercept the impinging energy flow. Because of the short distance radially across the conductor's cross section, a surface electron has very limited "field and field energy withdrawal" length.

211. (a) J. D. Jackson, "Surface charges on circuit wires and resistors play three roles," *Am. J. Phys.*, 64(7), July 1996, p. 855-870. See also (b) Mark A. Heald, "Energy flow in circuits with Faraday emf," *Am. J. Phys.*, Vol. 56, 1988, p. 540-547; (c) — "Electric fields and charges in elementary circuits," *Am. J. Phys.*, 52(6), June 1984, p. 522-526. The

surface charges in the conductors of a circuit are of enormous importance to the powering of the circuit.

212. See T. E. Bearden, "Energy Flow, Collection, and Dissipation in Overunity EM Devices," *Proc. 4th Internat. Energy Conf.*, Academy for New Energy, Denver, CO, May 23-27, 1997, p. 5-51. In Figure 5, p. 16 the fraction of the Poynting energy flow that is intercepted and collected by the circuit is roughly shown to be on the order of  $10^{-13}$  of the entire Poynting energy flow available. That number is based on a very crude estimating procedure, but even if off by several orders of magnitude, it shows that the Heaviside nondiverged energy flow component is orders of magnitude greater than the diverged Poynting component, for single-pass of the energy and collection only once.

213. Rigorously, there is no *power* in an EM energy flow, regardless of how great in magnitude, if it is not altered in form or diverged. That is because "power" is rigorously the time rate of doing work (time rate of *changing the form* of energy), not the time rate of energy flow per se. Exactly, the Heaviside dark energy flow component was some 10 trillion joules per second in magnitude, but it had zero watts of power. Unfortunately, electrical engineers just loosely refer to nondiverged **energy** flow as "power", regardless of the non sequitur. Hence inane terms **widely** used in electrical engineering (and texts) such as "draw power from **the** source", etc. Rigorously, *the power* (rate at which energy is changed in form) is developed locally in each component having losses or performing work — i.e., changing the form of the energy.

214. (a) T. E. Bearden, "On the Principles of Permissible Over **Unity** EM Power Systems," *J. New Energy*, 4(2), Fall 1999, p. 16-39; (b) Bearden, {17}; (c) — "Use of Asymmetrical Regauging and Multivalued Potentials to Achieve Overunity Electromagnetic Engines," *J. New Energy*, 1(2), Summer 1996, p. 60-78; (d) — "Regauging and **Multivalued** Magnetic Scalar Potential: Master Overunity Mechanisms," *Explore*, 7(1), 1996, p. 51-58; (e) — "The Master Principle of EM Overunity and the Japanese Overunity Engines," *Infinite Energy*, 1(5&6), Nov. **1995-Feb**, 1996, p. 38-55; (f) — "Use of Regauging and multivalued Potentials to Achieve Overunity EM Engines: Concepts and Specific Engine Examples," *Proc. Internat. Sci. Conf. "New Ideas in Natural Sciences"*, St. Petersburg, Russia, June 17-22, 1996, Part I: Problems of Modern Physics, 1996, p. 277-297.

215. In an oblique kind of sense, this is even "recognized" to some extent by leading electrodynamicists. E.g., quoting Jackson, {22}, p. 237: "...the Poynting vector is arbitrary to the extent that the curl of any vector field can be added to it. Such an added term can, however, have no physical consequences." So Jackson follows Lorentz's lead that any additional non-intercepted and uncollected energy flow permissibly accompanying the Poynting intercepted and collected component, has no physical significance. Both Lorentz and Jackson err as to the *finality* of the statement. The accompanying Heaviside component can have no physical significance *unless it is intercepted and collected by means other than the single circuit or mechanism considered, and the single pass of the entire energy flow onto and past the receiving entity (circuit, charge, etc.)*.
216. E.g., see Poynting, {4a. 4b}.
217. Heaviside, {5a}.
218. Heaviside, {5b}.
219. Heaviside, {5c}. Heaviside discusses the Faraday-Maxwell ether medium, outlines his vector algebra for analysis of vectors without quaternions, discusses magnetism, gives the EM equations in a moving medium, and gives the EM flux of energy in a stationary medium. On p. 443, he credits Poynting with being first to discover the formula for energy flow, with Heaviside himself independently discovering and interpreting this flow a little later by himself in an extended form.
220. J. H. Poynting, "On the connexion between electric current and the electric and magnetic inductions in the surrounding field," *Proc. Roy. Soc. Lond.* Vol. 38, 1984-85, p. 168.
221. Oliver Heaviside, *Electrical Papers*, Vol. 2, 1887, p. 94.
222. (a) T. E. Bearden, "On Extracting Electromagnetic Energy from the Vacuum," *Proc. IC-2000*, *ibid.*, 2000; (b) Bearden, {38a}.
223. Lorentz is believed to have done this earlier (perhaps circa 1890s). In 1902 he published the method in a book, which strongly implies it was first done in an earlier paper. See Lorentz, {109}. Figure 25 on p. 185 shows the Lorentz concept of integrating the Poynting vector around a closed cylindrical surface surrounding a volumetric element. Many thanks to Marcus Reid for furnishing a copy of the actual Lorentz reference from a library in Leipzig, Germany.

224. E.g., see (a) Panofsky and Phillips, {110}; (b) W. Gough and J. P. G. Richards, *European J. Phys.*, Vol. 7, 1986, p. 195.
225. Panofsky and Phillips, {110}, p. 180.
226. D. S. Jones, *The Theory of Electromagnetism*, Pergamon Press, Oxford, 1964, p. 52.
227. Jackson, {22}, p. 237.
228. W. M. Schwarz, *Intermediate Electromagnetic Theory*, John Wiley & Sons, New York, 1964, p. 280-281.
229. Jones, {226}, p. 53.
230. For typical references, see (a) J. Slepian, *Am. J. Phys.*, 19, 87 (1951); (b) Mario Iona, *ibid.*, 31, 398 (1963); (c) Udo Backhaus and Klaus Schafer, *ibid.*, 54, 279 (1986); (d) C. J. Carpenter, *IEE Proc. A (UK)*, 136A(2), Mar. 1989, p. 55-65; (e) J. A. Ferreira, *IEEE Trans. Edit.*, 31 (4), 1988, p. 257-264; (f) Mark A. Heald, *Am. J. Phys.*, 56(6), 1988, p. 540-547. The debate has also appeared in many other leading journals, e.g., (G) T. H. Boyer, *Phys. Rev. D*, 25, 3246 (1982). Interestingly, (h) M. Abraham and R. Becker, *The Classical Theory of Electricity and Magnetism*, Blackie, London, 1932, p. 146 and p. 194 give two examples of the controversy over the Poynting vector. Finally, see (i) D. F. Nelson *Phys. Rev. Lett.*, 76(25), June 17, 1996, p. 4713-4716 for advanced **work** requiring a greater generalization of the Poynting vector.
231. Sweet and Bearden, {29a}. Sweet's device produced 500 watts lit a 33 microwatt input, which is approximately a  $COP = 1.5 \times 10^6$ . By steadily increasing the COP to  $3 \times 10^6$ , the weight of the Sweet unit was reduced smoothly, reaching 90% reduction. The results of this highly successful anti-gravity experiment are reported in the paper. Unfortunately, Sweet later died and never fully revealed the activation secret by which barium ferrite magnetic materials could be triggered **into** strong self-oscillation at 60 Hertz or other ELF frequency.
232. Weaker self-oscillation of such permanent magnetic materials at higher frequency is known. E.g., see (a) V. S. L'vov, *Non-Linear Spin Waves*, Moscow, 1987; (b) L'vov, {29c}. See also (c) A. G. **Gurevich**, and G. A. Melkov, *Magnetization Oscillations and Waves*, CRC **Press**, Boca Raton, Florida, 1996. The latter authors give hundreds of **additional** references.



233. E.g., (a) M. W. Evans, P. K. Anastasovski, T. E. Bearden *et al*, "Derivation of the B(3) Field and Concomitant Vacuum Energy Density from the Sachs Theory of Electrodynamics," *Found. Phys. Lett.*, 14(6), Dec. 2001, p. 589-593; (b) — "Anti-Gravity Effects in the Sachs Theory of Electrodynamics," *Found. Phys. Lett.*, 14(6), Dec. 2001, p. 601-605; (c) Evans *et al.*, {38b}; (d) Evans *et al.*, {38c}; (e) -- "Operator Derivation of the Gauge Invariant Proca and Ehnert Equation: Elimination of the Lorentz Condition," *Found. Phys.*, 39(7), 2000, p. 1123-1130; (f) - "O(3) Electrodynamics from the Irreducible Representations of the Einstein Group," 2001, *Found. Phys. Lett.*, 15(2), Apr. 2002, p. 179-187.; (g) - "Effect of Vacuum Energy on the Atomic Spectra," *Found. Phys. Lett.*, 13(3), June 2000, p. 289-296; (h) Evans *et al.*, {113b}; (i) Evans *et al.*, {113a}; (j) - "On the Representation of the Maxwell-Heaviside Equations in Terms of the Barut Field Four-Vector," *Optik* 111(6), 2000, p. 246-248; — "Derivation of the B(3) Field and Concomitant Vacuum Energy Density from the Sachs Theory of Electrodynamics," *Found. Phys. Lett.*, (in press); (k) — "The New Maxwell Electrodynamics Equations: New Tools for New Technologies. A Collection of 60 papers from the Alpha Foundation's Institute for Advanced Study. Published as a Special Issue of the *J. New Energy*, 4(3), Winter 1999. See also (l) Bearden, (222b); (m) Bearden, {38a}; (n) Bearden, {43d}; (o) Bearden, {43a}; (p) Bearden, {30}; (q) Bearden, {40}; (r) Bearden {214}; (s) Bearden, {1214e}; (t) - "The Final Secret of Free Energy," *Magnets*, 7(5), May 1993, p. 4-26; (u) Bearden, {214f}.
234. Bearden, {40}.
235. Terence W. Barrett and Dale M. Grimes, (a) Preface, p. vii-viii, in (b) *Advanced Electromagnetism: Foundations, Theory, and Applications*, Terence W. Barrett and Dale M. Grimes (eds.), World Scientific, Singapore, 1995.
236. I. Prigogine, "Irreversibility as a symmetry-breaking process." *Nature*, Vol. 246, Nov. 9, 1973, p. 67-71.
237. Paul Davies, *Superforce: The Search for a Grand Unified Theory of Nature*, Simon and Schuster, New York, 1984, p. 105.
238. Clarke, {55}, p. 38.
239. T. D. Lee, *Symmetries, Asymmetries, and the World of Particles*, U. Wash. Press, Seattle, 1988, p. 11.

240. That is, it does not exist *openly* in the open literature. Several inventors do have working laboratory COP>1.0 experiments, and at least three of them have models which could rapidly be developed into production systems — say, in one year or less. However, the exact and detailed construction details are understandably maintained as deeply proprietary by the inventors, until their intellectual property rights can be secured, including foreign patent rights. On the other hand, many other inventors mistakenly believe they have COP>1.0 systems, but do not because of instrumental error, considering nonsinusoidal waves as measurable with RMS meters, or effects covered in Chapter 6 which they do not comprehend. In addition, there have been those more interested in selling stock than in producing a working system.

241. But see Kawai, {31}. The only available *open* details approaching the "kit of parts and instructions" point is the Kawai process, and it will work just as in the patent if carefully built. If very efficient photon-coupled switching of the flux path is used for build-ups, and if very high efficiency (0.7 to 0.8) magnetic motors are modified with the Kawai process, one can expect the COP of the modified motors to be double the conventional efficiency of the original base motor. So one can obtain COP = 1.4 to 1.6, e.g., by using the necessary and available Hitachi high efficiency motors (one at 0.7 and the other at 0.8) to start with. Hitachi engineers physically tested two high efficiency Hitachi motors modified by Kawai, at COP = 1.4 and COP = 1.6 respectively. Unfortunately, the Kawai process, engines, and company have been seized by what can **only** be described as the Yakuza (Japanese Mafia) and are being held off **the** market. The seizure was accomplished here in Huntsville, Alabama, witnessed by the CTEC board of directors and I, when Kawai and **CTEC** were in final negotiations to rapidly develop and market the Kawai **system**. Several other COP>1.0 Japanese engines have also been seized and withheld by the Yakuza.

242. Jed Z. Buchwald, *From Maxwell to Microphysics*, University of Chicago Press, Chicago and London, 1985, p. 44.

243. Whittaker, {85}.

244. Bearden, {12}.

245. Mandl and Shaw, {19}.

246. Whittaker, {91a}.

247. To see how arduous a search Kron himself made prior to achieving a proper model for an electrical circuit, see Kron, {162}. The quote is from p. 114.

248. For example, Kron, {192}.

249. P. A. M. Dirac, "A theory of electrons and protons," *Proc. Roy. Soc. Lond. A*, 126(801), Jan. 1, 1930, p. 360-365. Here Dirac introduced the vacuum energy — the electron sea filled with electrons occupying negative energy states. The holes are treated today as the positive electrons. This concept is now referred to as the "Dirac Sea," and the concept has been expanded to include negative energy "holes" for other kinds of particles. Dirac first attempted to identify these holes with protons, until later the positron was discovered.

250. Evans, {137b}.

251. (a) Evans, {137a}; (b) — "The Link Between the Topological Theory of Ranada and Trueba, the Sachs Theory, and  $0(3)$  Electrostatics," *ibid.*, vol. 2, p. 495-499.

252. (a) Sachs, {126a}. The Sachs theory provides a great generalization of general relativity and electrodynamics reaching from the quarks and gluons to the entire universe. See also (b) Sachs, {126b}.

253. Indeed, the symmetrizing of Maxwell's equations was first accomplished by Lorenz. See (a) Lorenz, {161a}. In this paper Lorenz gave essentially what today is called the Lorentz symmetrical regauging. AS pointed out by Barrett, the Lorenz paper gave  $f(t-r/c)$  functions. Fitzgerald said that Lorenz's functions were essentially the same as his, and Fitzgerald became a leading proponent of "retarded potentials". But it is believed that Fitzgerald was unaware of Lorenz's work until the 1880's, so he is given credit for parallel development. Some people speak of Fitzgerald-Lorenz functions. This is a regauging, but the term "gauge" (inspired by railroad gauges) was first introduced by Hermann Weyl in the 1900s. He used it for a change in length and was quickly countered by Einstein - Weyl's theory was not relativistic. The idea resurfaced in the 1920s when quantum theory was being formulated, but this time it meant "change in phase" and not "change in length". At any rate, when the renowned H. A. Lorentz performed the symmetrizing of the Maxwell-Heaviside equations in the 1880s, it was adopted immediately and has been rather universally applied since then. See also (b) Jackson and Okun {161b} for a history of gauge invariance.

254. (a) Prigogine, {160a}; (b) G. Nicolis and I. Prigogine, {160d}; (c) T. Petrosky and I. Prigogine, "Quantum Chaos, Complex Spectral Representation and Time-Symmetry Breaking," *Chaos, Solitons, and Fractals*, Vol. 4, 1994, p. 311-359; (d) D. Kondepudi and I. Prigogine, "Thermodynamics, Nonequilibrium," *Encyclopedia of Applied Physics*, Vol. 21, 1997, p. 311-337; (e) D. Kondepudi and I. Prigogine, *Modern Thermodynamics: From Heat Engines to Dissipative Structures*, Wiley, Chichester, 1998; (f) T. Petrosky and I. Prigogine, "Laws of Nature, Probability and Time Symmetry Breaking," *Physica A*, Vol. 263, 1999, p. 528-539.
255. (a) G. Nicolis, and I. Prigogine, *Exploring Complexity*, Piper, Munich. 1987; (b) — *Exploring Complexity: An Introduction*, Freeman, New York, 1989; (c) G. Nicolis, {160e}.
256. Letokhov, {157a-157d}.
257. Bohren, {24}.
258. Paul and Fischer, {25}.
259. E.g., see (a) Patrick et al., {37}. For rigorous explanations of **how** the energy is extracted from the vacuum, see (b) Evans et al., {38b}; (c) Evans et al., {38c}. The vacuum can and will furnish an electromagnetic "wind" from which useful EM energy can be extracted. Indeed, every source charge and dipole already extracts and continuously pours out EM energy from the vacuum, thereby establishing its fields and potentials (**and** their energy) across the universe.
260. A relationship between gamma bursters and a big bang is suggested from some recent observations. On Jan. 23, 1999 the Hubble Space Telescope caught an optical flash simultaneous with an initial gamma burst. When calculated, this burst was second in energy only to the big bang itself, and generated about  $3.4 \times 10^{54}$  ergs, which is the equivalent of converting two solar masses instantaneously into energy. There was also no polarization of the afterglow, which has been taken as evidence of beaming. However, such beaming could also be due to the beaming involved in the intense iterative phase conjugate reflections of the asymmetrical self-regauging process in intensely scattering, optically active, energy-amplifying media.
261. Heaviside, {5a-5c}.
262. Josephs, {172a}; Laithwaite, {172b}.

263. (a) Diederik Wiersma and Ad Lagendijk, "Laser Action in Very White Paint," *Physics World*, Jan. 1997, p. 33-37; (b) K. Totsuka, G. van Soest, T. Ito, A. Lagendijk, and M. Tomita, "Amplification and diffusion of spontaneous emission in strongly scattering medium," *J. Appl. Phys.*, Vol. 87, 2000, p. 7623-7628.

264. (a) A. Lagendijk, J. Gomez Rivas, A. Imhof, and R. Sprik, "Propagation of light in disordered semiconductor materials," in *Photonic Crystals and Light Localization in the 21st Century*, edited by C. M. Soukoulis, Kluwer, Dordrecht, 2001, p. 447-473; (b) H. Cao *et al.*, "Spatial Confinement of Laser Light in Active Random Media," *Phys. Rev. Lett.*, 84(24), 12 Jun. 2000, p. 5584-5587.

265. We also point out the possibility of the accumulator at each end being an intensely scattering, photoreactive, energy-amplifying material, a subject discussed a bit later in this chapter.

266. (a) Werner Triftshauser *et al.*, *Phys. Rev. Lett.*, Vol. 87, 2001. An overview is given by (b) Philip Ball, "The Positron Probe," *Nature*, Vol. 412, Aug. 23, 2001, p. 764.

267. For example, see Letokhov, {157a-157d}.

268. Jackson, {22}, p. 363, third footnote.

269. Kraus, {10}, p. 4.

270. Marconi's patent is Guglielmo Marconi, "Transmitting Electrical Signals," U.S. Patent 586,193, July 2, 1897. Filed Dec. 7, 1896, with 56 claims. This patent was overturned in 1943 by the U.S. Supreme Court, and prior work by Nikola Tesla for transmission of EM signals was upheld. Most textbooks and journals, etc. to this day continue to falsely credit Marconi with discovery of the transmission of EM signals and thus the discovery of radio. This is not to discredit the important work that Marconi did; without him, signal transmission would have been much longer in coming.

271. *United States Reports: Cases Adjudged in the Supreme Court of the United States*, Vol. 320, Marconi Wireless Telegraph Co. of America vs. United States, June 21, 1943, p. 1-80. The U.S. Supreme Court ruled that Tesla's fundamental radio patents had anticipated all other contenders, including Marconi.

272. *Dictionary of Scientific and Technical Terms*, Daniel N. Lapedes (editor in chief), McGraw-Hill, New York, 1974, p. 300. On page 517 of the second and expanded edition (1978), the same definition of electric field appears and is unchanged.
273. H. J. Gray and Alan Isaacs, *A New Dictionary of Physics*, Longman, London, second edition, second impression, 1976.
274. Feynman, {7}, p. 2-4.
275. Feynman, {7}, p. 12-2.
276. P. K. L. Drude, *Ann. Physik*, Vol. 1, p. 566; Vol. 3, 1900, p. 370, 869. Here Drude first develops a theory of conductivity in a metal based on the assumption that there is a gas of free electrons in the metal. This gas of conduction electrons is often referred to as the "Drude gas." Note that this was shortly after J. J. Thomson's discovery of the electron in 1897.
277. E.g., see Jackson, {211a}.
278. Romer, {84}, endnote 24, p. 109.
279. H. Winfield Secor, "Tesla Maps Our Electrical Future."
280. Nikola Tesla, "Pioneer Radio Engineer Gives Views on Power," *New York Herald Tribune*, Sep. 11, 1932.
281. Nikola Tesla, "The True Wireless," *Electrical Experimenter*, May 1919.
282. Burford and Verner, {35a}. Quote is from p. 281.
283. That is, it does not exist *openly* in the open literature. Several inventors do have working laboratory COP>1.0 experiments, and at **least** three of them have models which could rapidly be developed into production systems — say, in one year or less.
284. But see Kawai, {31}.
285. Barrett, {124}.
286. (a) Terence W. Barrett, "Active Signalling [sic] Systems," U.S. Patent No. 5,486,833, Jan. 23, 1996; (b) — "Oscillator-Shuttle-Circuit (OSC) Networks for Conditioning Energy in Higher-Order Symmetry Algebraic Topological Forms and RF Phase Conjugation," U.S. Patent No. 5,493,691, Feb. 20, 1996.

287. No proper scientific treatise on the Moray device has ever been published, to our knowledge, nor has a proper theory of its operation been developed. Anecdotal material and some technical material is contained in (a) T. H. Moray, *The Sea of Energy*, 5th Edn., Salt Lake City, 1978 (foreword by T. E. Bearden). The fourth edition of the book, titled (b) *The Sea of Energy in Which the Earth Floats*, contains additional material but is long out of print. Additional information is given in (c) Keith Tutt, *The Search for Free Energy*, Simon & Schuster, 2001, p. 33-68. (d) Paul Brown's study of the Moray work is "The Moray Energy Device: Operational Parameters, Design Criteria, and Considerations," date unknown. Researcher and inventor Bruce Perreault has based much of his own work with his radiant energy valve on Moray's work. Perreault proposes a different interpretation. In the present book we have tried to point out the various aspects of the Moray device that resemble other presently known effects — most of which were still unknown in the 1920s and 1930s when Moray's fundamental work was accomplished.

**288.** Moray, {34b} "Electrotherapeutic Apparatus," U.S. Patent No. 2,460,707, Feb. 1, 1949. This patent clearly shows the complexity of the various special tubes containing his pellets that Moray developed.

289. H. C. Dake and Jack DeMent, *Fluorescent Light and Its Applications*, Chemical Publishing Company, Inc., Brooklyn, New York, 1941, p. 51-52 gives a succinct discussion of Stokes emission and anti-Stokes emission.

**290.** Sir G. G. Stokes, "On the Change of Refrangibility of Light," a memoir, 1852.

291 For example, in 1935 Prileshajewa showed that there is an energy difference involving as much as 1.1 V between the exciting light and the fluorescence of aniline vapor.

292. V. S. Letokhov, {157a-157d}.

293. Letokhov, *ibid.*

**294.** E.g., (a) R. N. Bhargava and D. Gallagher, "Optical Properties of Manganese-Doped Nanocrystals of ZnS," *The Am- Phys. Soc.*, 72(3), Jan. 17, 1994; (b) I. A. Izmailov et al., "Generation of Stimulated Noncoherent Radiation in Light-Scattering Media Exhibiting Chemical Reactions," *Sov. J. Quantum Electronics*, 12(5), May. 1982, p. 588-594; (c) R. Pappalardo and A. Lempicki, "Brillouin and Rayleigh Scattering in Aprotic Laser

Solutions Containing neodymium," *J. Appl. Phys.*, Apr. 1992, p. 1699-1708.

295. (a) Nabil M. Lawandy *et al.*, "Laser action in strongly scattering media," *Nature*, Vol. 368, Mar. 31, 1994, p. 436-438. For a good lay article with color pictures, see (b) Ivars Peterson, "Boosted light: Laser action in white paint," *Science News*, 145(15), Apr. 9, 1994, p. 228-229. See also (c) P. Mandel, "Lasing without inversion: A useful concept?," *Contemp. Phys.*, Vol. 34, 1993, p. 335; (d) O Kocharovskaya, "Amplification and lasing without inversion," *Physics Reports*, Vol. 219, 1992, p. 175.

296. Some useful papers are: (a) Diederik S. Wiersma and Ad Lagendijk, "Light diffusion with gain and random lasers," *Phys. Rev. E*, 54(4), Oct. 1996, p. 4256-4265. The authors discuss experimental considerations for a medium that both multiply scatters and amplifies light, and distinguish three regimes; (b) H. Cao *et al.*, "Random Laser Action in Semiconductor Powder," *Phys. Rev. Lett.*, 82(11), 15 Mar. 1999, p. 2278-2281. The authors observed random laser emission in all directions, with coherent feedback, in semiconductor powder, (c) Diederik S. Wiersma, Meint P. van Albada and Ad Lagendijk, "Coherent Backscattering of Light from Amplifying Random Media," *Phys. Rev. Lett.*, 75(9), 28 Aug., 1995, p. 1739-1742. (d) D. S. Wiersma, P. Bartolini, A. Lagendijk, and R. Righini, *Nature*, Vol. 390, 1997, p. 671. The authors report Anderson localization of photons in GaAs powder, (e) Ad Lagendijk *et al.*, "Microscopic Approach to the Lorentz Cavity in Dielectrics," *Phys. Rev. Lett.*, 79(4), 28 July 1997, p. 657-660. (f) Pedro de Vries and Ad Lagendijk, "Resonant Scattering and Spontaneous Emission in **Dielectrics** Microscopic Derivation of Local-Field Effects," *Phys. Rev. Lett.*, 81(7), 17 Aug. 1998, p. 1381-1384. (g) Gijs van Soest, Makoto Tomita, and Ad Lagendijk, "Amplifying volume in scattering media," *Opt. Lett.*, 24(5), Mar. 1, 1999, p. 306-308.

297. S. Itoh *et al.*, "Simulational and experimental studies on anomalous reflectivity of phase conjugate wave," *Ferroelectrics*, vol. 170, 1995, p. 209-217.

298. See (a) D. P. Hand and P. St. J. Russell, "Solitary thermal shock waves and optical damage in optical fibers," *IEE Colloquium on 'Non Linear Optical Waveguides'*, *LEE Digest* No. 88, London, England, 1988, p. 101-103; (b) — "Soliton-like thermal shock-waves in optical fibres: origin of periodic damage tracks," *Fourteenth European Conference on*



*Optical Communication (ECOC 1988)*, Sep. 11-15, 1988, Publication No. 292, 1(2), 1988, p. 111-114; (c) — "Solitary thermal shock waves and optical damage in optical fibers: the fiber fuse," *Opt. Lett.*, 13(9), Sep. 1988, p. 767-769; (d) D. P. Hand and T. A. Birks, "Single-mode tapers as 'fibre fuse' damage circuit-breakers," *Electronics Lett.*, 25(1), Jan. 5, 1989, p.33-34. For an excellent lay description with photographs, see (e) Ivars Peterson, "Fibers with Flare," *Sci. News*, 140(13), Sep. 8, 1991, p. 200-201

299. P. St. J. Russell, "Power Conservation and Field Structures in Uniform Dielectric Gratings," *J. Opt. Soc. America A.*, 1(3), Mar. 3, 1984, p. 293-299. Russell is referring to apparent violation of local conservation of energy. It is true in the conventional flawed energy flow analysis considering only the Poynting component, because the fuse produces more work output (melting the holes) than the original operator's input of Poynting energy to initiate the fuse effect. It does not produce more work output than the total of the energy input by the operator in both the accounted Poynting component and the unaccounted Heaviside component. It merely shows that the extra fiber fuse ignition actions do absorb extra energy from the Heaviside component, perhaps by particle resonance (Bohren effect) of the melt and vapor particles. Also, intense heating produces intense ionization and thus intense dipoles, thus producing broken symmetry in the fierce exchange with the active vacuum. Multiple retroreflections of the EM energy flow also occur in the nmelt and vapor particles, leading to multiple collections in the ping-pong of a joule of energy between two particles as phase conjugate mirrors.

300. E.g., see (a) H. Kogelnik, "Coupled wave theory for thick hologram gratings," *Bell Systems Technical Journal*, Vol. 48, 1969, p. 2909-2947; (b) Z. Zylbergberg and E. Marom, "Rigorous coupled-wave analysis of pure reflection gratings," *J. Opt. Soc. Am.*, Vol. 71, 1981, p. 811-818; (c) — "Rigorous coupled-wave analysis of grating diffraction — E- mode polarization and losses," *ibid.*, Vol. 73, 1983, p. 451-455; (d) — "Comments on analyses of reflection gratings," *ibid.*, Vol. 73, 1983, p. 399-401.

**301.** Bohren, {24J.

302. Justin Mullins, "Superpowerful Explosive Arrives with a Bang." *New Scientist*, Aug. 4, 2001.

303. Romano M. DeSantis *et al.*, "On the Analysis of Feedback Systems With a Multipower Open Loop Chain," Oct. 1973, AD 773188, available through the Defense Technical Information Center or the National Technical Information Center. The paper clearly shows that such systems can produce overunity coefficient of performance.

304. See (a) J. H. Andreatta, "High Power Switching Amplifier Wherein Energy is Transferred to a Tuned Circuit During Both Half Cycles," U.S. Patent No. 3,239,771, Mar. 8, 1966; (b) Tom L. Dennis Jr., "Highly Efficient Semiconductor Switching Amplifier," U.S. Patent No. 3,239,772, Mar. 8, 1966; (c) Heber J. Morrison, "Square Wave Driven Power Amplifier," U.S. Patent No. 3,815,030, June 4, 1974.

305. For a good but conventional coverage of many differential negative resistors and negative conductors, see Adolf Fritz Schwarz, "Negative Resistors and Negative Conductors," Doctoral Thesis, Technische Hogeschool, Delft (Netherlands), Feb. 1969, available from the U.S. National Technical Information Service (NTIS), Springfield, VA. True negative resistors are dismissed as impossible in Schwarz's opening remarks. And they *are* impossible in equilibrium systems not receiving and using any net excess energy asymmetrically from their environment, which are the only systems conventionally considered by electrical engineers and electrodynamicists.

306. Gabriel Kron, "Numerical solution of ordinary and partial differential equations by means of equivalent circuits." *J. Appl. Phys.*, Vol. 16, Mar. 1945a, p. 173.

307. Kron, {32}, p. 39.

308. Bearden, {12}.

309. E.g., see Gabriel Kron, "Equivalent Circuits for Oscillating Systems and the Riemann-Christoffel Curvature Tensor," *General Electric Review*, Jan. 1943, p. 25-31.

310. See (a) S. Austen Stigant, "Gabriel Kron on Tensor Analysis, A bibliographical record," *BEAMA Journal*, Aug. 1948, for a full bibliography of Kron's publications up to 1948. Also useful are (b) Gabriel Kron, "A Method to Solve Very Large Physical Systems in Easy Methods," *IRE Transactions on Circuit Theory*, 2(1), Dec. 1953, p. 71-90; (c) P. L. Alger, editor, *The Life and Times of Gabriel Kron, or Walking Around the World, and Tensors*, Mohawk Development Services, Inc.,

Schenectady, NY, 1969; (d) Banesh Hoffman, "Cron's Non-Riemannian Electrodynamics," *Rev. Mod. Phys.*, 21(3), 1949, x 535-540; (e) K. Kondo and Y. Ishizuka, "Recapitulation of the Geometrical Aspects of Gabriel Kron's Non-Riemannian Electrodynamics," Research Association of Applied Geometry, *Memoirs of the Unifying Study of Basic Problems in Engineering and Physical Sciences by Means of Geometry*, Gakujutsu Bunkai Fukyu-kai, Tokyo, Vol. I, 1955, p. 185-239 [particularly see footnote 1, p. 222];

311. Wang and Chung, {33}.

312. Deborah D. L. Chung, "Superconductor-metal laminates and method of making," U.S. patent no. 5,059,582, issued Oct. 22, 1991. A superconducting laminate having at least one layer of metal and at least one layer of superconducting material. The metal layer and the superconducting layer are bonded. The layer may also include carbon fibers from various precursors. The superconductor may be a composite material. The invention also includes a method of making the laminates. Assigned to The Research Foundation of State University of NY, Albany, NY.

313. Jean-Louis Naudin, website <http://jnaudin.free.fr/cnr/>.

314. Fogal, {36a, 36b}.

315. As one example, Fogal's device has to be able to manipulate Dirac holes in the vacuum itself, at least to some extent. Once the erroneous flat spacetime assumption of classical electrodynamics is removed and curved local spacetime considered, we can and will have Dirac holes in the local vacuum itself, especially in COP $\gg$ 1.0 systems. In a COP $\gg$ 1.0 system, not all the Dirac holes have interacted with orbital electrons in atoms to "eat" an electron and produce a positive ion — with a "lattice hole" or "lattice positron" where the electron had been. There is a vast difference between a Dirac hole positron (which has a negative mass equal in magnitude to one electron-mass) and a lattice hole (which is attached to the relatively huge positive mass of the ionized atom. Hence the mobility and phenomenology of Dirac positrons and lattice positrons are very different. There presently are no books on the dynamics of the Dirac negative energy electron holes in COP $\gg$ 1.0 EM circuits and systems.

316. Mandl and Shaw, {19}.

317. Whittaker, {91a}. The paper was published in 1904 and orally delivered in 1903. Note: On p. 368 midpage, Whittaker's equation for the y-component of vector-potential "a" is missing the exponent "2" on the ~~del~~ operator.
318. Rodrigues and Lu, {93a}.
319. Rodrigues and Vaz, {93b}.
320. It is certainly not lacking in the secret military weapons game. Some 10 nations of the world have weaponized longitudinal EM wave weapons over the past few decades, and almost every major weapons laboratory in the world has now "discovered" longitudinal EM waves. Even the Yakuza (Japanese Mafia) has acquired its own portable longitudinal EM interferometry weapons.
321. Evans et al., {79}.
322. (a) V. I. Arkhipov, *et al.*, "Negative transient currents in amorphous semiconductors." *Internat. J. Electronics* (UK), 51(6), 1981, p. 735-742; (b) — and A. I. Rudenko, "Negative currents caused by injection-controlled polarization," *Solid. St. Commun.*, 28, 1978, p. 675-676.
323. Jackson, {22}, p. 222.
324. Jackson, {22}, p. 223.
325. O. L. Brill and B. Goodman, *Am. J. Phys.*, vol. 35, 1967, p. 832.
326. For example, see Jackson, {22}, p. 219-221.
327. We stress that electrodynamicists, conventional theory, and quantum field theory all assume the principle of *gauge freedom*, the **total** freedom to change the gauge (and therefore any potential) in a Maxwellian system at any time, without cost or work. In the real world one may have to pay a little switching costs, but by simply regauging one can freely change the EM energy physically present at a point in 3-space **occupied by** the Fogal "freed" instantaneous scalar potential, once the electrons are pinned. In short, the Fogal process is able to directly "gate" the instantaneous transduction of EM energy existing at multiple points **in** space, simultaneously. There is nothing in the gauge freedom **principle** that restricts (i) regauging the instantaneous scalar potential at will, **or** (ii) using these changes at a distance to produce force fields upon electrons, thereby moving them — so long as one employs a Fogal semiconductor in

the "distant receiver" in order to be able to produce the back-transition from the field-free state to the force-field state by removing the anomalous pinning restriction. To the advanced theorists, we leave the debates over causality considerations for this demonstrated process!

328. Whittaker, {85}.

329. (a) W. Heitman and G. Nimtz, "On Causality Proofs of Superluminal Barrier Transversal of Frequency Band Limited Wave Packets," *Phys. Lett. A196*, 1994, p. 154-158; (b) Enders and Nimtz, {136b}.

330. The reader should recall that the Lorenz/Lorentz condition, which limits the circuit to  $COP < 1.0$ , is self-applied by the circuit when it rams all "spent" electrons in the ground return line back through the emf of the circuit. One need not do that, and need not produce that force field that destroys the primary source dipole and its extraction of EM energy from the vacuum via its broken symmetry. As the reader has undoubtedly now observed, the "back-emf" and "back mmf" are those aspects in an electrical circuit and magnetic circuit respectively, that kill the dipole and physically self-apply and self-enforce Lorenz/Lorentz symmetrical regauging. Hence the intuitive concern of  $COP > 1.0$  experimenters to try to discover how to avoid or lessen the "back emf" or the "back mmf" in their circuits and systems.

331. Philip Ball, "The positron probe," *Nature*, Vol. 412, 23 Aug. 2001, p. 764.

332. Werner Triftshauer et al., *Phys. Rev. Lett.*, 87, 067402 (2001).

333. Bearden, {30}.

334. For the chemistry and currents of the battery, see any good battery reference, such as Colin A. Vincent and Bruno Scrosati, *Modern Batteries: An Introduction to Electrochemical Power Sources*, Second Edition. Wiley, New York, 1997.

335. (a) J. O'M. Bockris, A. K. N. Reddy, and M. Gamboa-Aldeco, *Modern Electrochemistry: Fundamentals of Electrodics*, 2nd edition. Kluwer/Plenum, NY 2000; (b) J. O'M. Bockris and A. K. N. Reddy, *Modern Electrochemistry: Electrodics in Chemistry, Engineering, Biology, and Environmental Science*, 2nd edition, Kluwer/Plenum, NY 2000; (c) J. Koryta, J. Dvorak, and L. Kavan, *Principles of Electrochemistry*, 2nd ed.. Wiley, NY, 1993; (d) Wolfgang .I. Lorenz and Waldfried Plieth,

*Electrochemical Nanotechnology: In Situ Local Probe Techniques at Electrochemical Interfaces*, Wiley, NY, 1998; (e) B. E. Conway, *Electrochemical Supercapacitors: Scientific Fundamentals and Technological Applications*, Plenum, NY, 1999; (f) Allen J. Bard and Larry R. Faulkner, *Electrochemical Methods: Fundamentals and Applications*, Second Edition, Wiley, NY, 2001.

336. At this writing, a provisional patent application on the process has been filed by Bedini and the present author. By the time of publication, hopefully this will have been turned into a formal patent application, with foreign patents also applied for.

337. Edwin V. Gray, "Pulsed Capacitor Discharge Electric Engine," U.S. Patent #3,890,548, June 17, 1975.

338. (a) Per Whittaker, {85}. However, see (b) Bearden, {12} for a necessary correction of Whittaker's interpretation to accord with a quantum field theory view of the instantaneous scalar potential. After observation, the phase conjugate EM wave half of the Whittaker wavepair is indeed going in the opposite direction to the normal longitudinal EM wave half. But prior to observation, it exists in the time domain, and in the time domain it is precisely accompanying the 3-space longitudinal EM wave, with the absorbing and then emitting charge interacting in the middle between the two. See (c) Mandl and Shaw, {19}, to see that the combined scalar (time-polarized) photon and longitudinal photon are observable as the instantaneous scalar potential. This means that the corrected Whittaker decomposition produces an associated time-polarized EM wave in the time domain and longitudinal EM wave in 3-space. That is the corrected interpretation of Whittaker's phase conjugate longitudinal EM wavepair.

339. (a) J. O'M. Bockris, "Overpotential: a lacuna in scientific knowledge," *J. Chem. Edu.*, 48(6), June 1971, p. 352-358. This is a simplified introduction to overpotential theory. The energy density that exists at minute "double layers" in contact, which act as tiny capacitors with extremely small separation of plates, is enormous and far greater **than** what the power engineer meets in his normal engineering practice. **See** also (b) Bockris and Reddy, {335b}, particularly Chapter I which deals with the overpotential. See also (c) Bockris et al, {335a}.

340. E.g. see (a) L. Bertalot *et al.*, "Study of deuterium charging in palladium by the electrolysis of heavy water: heat excess production", *Nuovo Cimento*, Vol. 15 D, 1993, p. 1435; (b) J. O'M Bockris *et al.*, "Cold

fusion as a consequence of high fugacity among hydrogen isotopes," *Intl. J. Hydrogen Energy*, Vol. 17, 1992, p. 445.

341. Peter Lindemann, *The Free Energy Secrets of Cold Electricity*, Clear Tech Inc., Metaline Falls, WA, 2001.

342. Particularly see Kenneth S. Deffeyes, *Hubbert's Peak: The Impending World Oil Shortage*, Princeton University Press, Princeton, NJ, **2001**.

Quoting: "*Deffeyes finds that world oil production will peak within five wars and that there isn't anything we can do to stop it. New exploration and production technologies can't save us, and plans to open the Arctic National Wildlife Refuge and other areas to drilling offer no more than a small and soon-to-be-forgotten blip on the production curve. While long-term solutions exist in the form of conservation and alternative energy sources, they probably cannot — and almost certainly will not — be enacted in time to evade a short-term catastrophe of shortages, soaring prices, and global economic, agricultural, and possibly political disturbance.*" In short, Deffeyes rigorously demonstrates that a world energy crisis of staggering proportions is just around the corner.

343. D. J. Bohm and B. J. Hiley, "On the intuitive understanding of nonlocality as implied by quantum theory," *Found. Phys.*, 5(1), Mar. 1975, p. 93-109. Quote is from p. 107.

344. (a) Y. Aharonov and D. Bohm, "Significance of Electromagnetic Potentials in the Quantum Theory," *Phys. Rev.*, Second Series, 115(3), Aug. 1, 1959, p. 485; (b) — "Further Considerations on Electromagnetics In the Quantum Theory," *Phys. Rev.*, 123(4), Aug. 15, 1961, p. 1511-1524.

345. Terence W. Barrett, "Electromagnetic Phenomena Not Explained by Maxwell's Equations," A. Lakhtakia, ed., *Essays on the Formal Aspects of Electromagnetics Theory*, World Scientific Publishing, River Edge, NJ, **1993**, p. 11 and generally p. 6-86.]

346. Davies, {237}, p. 105.

347. David J. Bohm, "A Suggested Interpretation of the Quantum Theory in Terms of 'Hidden' Variables, I and II." *Phys. Rev.*, 85(2), Jan. 15, 1952, p. 166-179 (Part I); 180-193 (Part II).

348. Jackson, {22}, p. 223.

349. Lamb and Retherford, {23}.

350. (a) Casimir, {26}. This paper is an extrapolation to two attracting plates of the more detailed paper of (b) H. B. G. Casimir and D. Polder, "The influence of retardation on the London-van der Waals Forces," *Phys Rev.* 73(4), Feb. 15, 1948, p. 360-372. Casimir's paper was an extension of earlier work by Verwey and Overbeek on the stability of colloidal systems, including the interaction of electric double layers; see (c) E. J. W Verwey, J. T. G. Overbeek, and K. van Nes, *Theory of the Stability of Lyophobic Colloids*, Elsevier, Amsterdam, 1948.

351. Lamoreaux, {27}.

352. Mead and Nachamkin, {28}.

353. E.g., see (a) P. W. Milonni, R. J. Cook and M. E. Goggin, "Radiation pressure from the vacuum: Physical interpretation of the Casimir force," *Phys. Rev. A*, Vol. 38, 1988, p. 1621; (b) C. E. Carlson, T. Goldman and J. Peres-Mercader, "Gamma-ray bursts, neutron star quakes, and the Casimir effect," *Europhys. Lett.*, Vol. 36, 1996, p. 637; (c) M. Chaichian *et al*., "Quantum theories on noncommutative spaces with nontrivial topology: Aharonov-Bohm and Casimir effects," *Nucl Phys B*. Vol. 611, 2001, p. 383-402; (d) V. Dodonov, "Nonstationary Casimir Effect and Analytical Solutions for Quantum Fields in Cavities with Moving Boundaries," in *Modern Nonlinear Optics*, 2nd Edn., 3 vols., Wiley, 2001, Vol. 1, p. 309-384.

354. Bohm, {347}.

355. See T. E. Bearden, *Gravitobiology: A New Biophysics*, Tesla Book Co., Chula Vista, CA, 1991.

356. One should not be nonplussed at the notion of infinite velocity. A pure longitudinal EM wave is — at least in theory — capable of moving at infinite velocity, and is a proper solution to Maxwell's equations. See (a) Rodrigues and Lu, {93a}. Also, the ordinary potential in the Coulomb gauge does indeed move at infinite velocity; see Jackson, {22}, p. 223. In addition, Bohm's interpretation of quantum mechanics {347} uses the quantum potential, which instantaneously appears everywhere it will have magnitude.

357. Enders and Nimtz, {329b}.

358. R. Chen, "Cancellation of Internal Forces," *Am. J. Phys.*, 49(4), Apr. 1981, p. 372.



359. Whittaker, {85}.

360. R. L. Davis, "Non-Inductive Electrical Resistor," U.S. Patent No. 3,267,406, Aug. 16, 1966. Davis uses a Mobius-loop capacitor as an inductance-free resistor. Our comment is that, more rigorously, the resistor is *not* noninductive. It is "equally and oppositely inductive," which is quite a different thing altogether when one considers the difference between internal energy and external energy. We hypothesize that the "resistor" — or some version of it — produces an artificial scalar potential stress in spacetime — apparently varying the stress energy tensor itself— even though it produces a *net* zero reactance.

361. These are Brazil, Russia, China, and two other nations friendly to the U.S. The dominant weapons on earth today are quantum potential weapons, not nuclear weapons. The second most dominant weapons are probably the negative energy EMP weapons deployed by several nations, including China.

362. E.g., see (a) L. I. Mandelstam and N. D. Papaleksi, "On the parametric excitation of electric oscillations," *Zhurnal Tekhnicheskoy Fiziki*, 4(1), 1934, p. 5-29; (b) — "On resonance phenomena with frequency distribution." *Z.f. Phys.*, No. 72, 1931, p. 223; (c) — "Concerning asynchronous excitation of oscillations," *Zhurnal Tekhnicheskoy Fiziki*, 4(1), 1934; (d) — "Concerning asynchronous excitation of oscillations," *Zhurnal Tekhnicheskoy Fiziki*, 4(1), 1934; (e) — "Concerning nonstationary processes occurring in the case of resonance phenomena of the second class," *Zhurnal Tekhnicheskoy Fiziki*, 4(1), 1934. See also (f) A. Andronov, "The limiting cycles of Poincare and the theory of self-maintained oscillations," *Comptes-Rendus*, Vol. 189, 1929, p. 559; (g) — and A. Witt, "On the mathematical theory of self-excitations," *Comptes-Rendus*, Vol. 190, 1930, p. 256; (h) — "On the mathematical theory of self-excitation systems with two degrees of freedom," *Zhurnal Tekhnicheskoy Fiziki*, 4(1), 1934; (i) — "Discontinuous periodic movements and theory of multivibrators of Abraham and Bloch," *Bull. De l'Acad. Ed Sc. De l'URSS*, vol. 189, 1930. See (j) S. Chaikin, "Continuous and 'discontinuous' oscillations," *Zhurnal Prikladnoy Fiziki*, Vol. 7, 1930. p. 6; (k) — and A. Witt, "Drift in a case of small amplitudes," *Zhurnal Tekhnicheskoy Fiziki*, 1(5), 1931, p. 428; (l) — and N. Kaidanowski, "Mechanical relaxation oscillations," *Zhurnal Tekhnicheskoy Fiziki*, Vol. 3, 1933, p. 1.

363. L. Mandelstam [L. T. Mendel'shtam], N. Papalexi, A. Andronov, S. Chaikin and A. Witt, "Report on Recent Research on Nonlinear Oscillations," Translation of "Expose Des Recherches Recentes Sur Les Oscillations Non Lineaires," *Technical Physics of the USSR*, Leningrad, Vol. 2, 1935, p. 81-134 [NASA Translation Doc. TTF-12,678, Nov. 1969].
364. In Alexander L. Fradkov and Alexander Yu. Pogromsky, *Introduction to Control of Oscillations and Chaos*, World Scientific Series on Nonlinear Science E, Series Editor Leon O. Chua, World Scientific, New Jersey, 1998 — as a typical example — I found no mention of the Dirac hole current decay mechanism or of the active external environment (the active vacuum and its dynamics, and the active local curvatures of spacetime and their dynamics).
365. Richard E. Prange and Peter Strance, "The Semiconducting Vacuum," *Am. J. Phys.*, 52(1), Jan. 1984, p. 19-21.
366. John F. Lindner *et al.*, "Noise Enhanced Propagation," *Phys. Rev. Lett.*, 81(23), 7 Dec. 1998, p. 5048-5051. Lindner suggests that the mechanism appears to be general, in which case it could supply the mechanism that coherently "locks together" the barium nuclei self-oscillations in Sweet's activated barium ferrite magnets.
367. Owen Flynn, "Parametric arrays: A new concept for sonar," *Electronic Warfare Magazine*, June 1977, p. 107-112. Any two sine-wave frequencies as simultaneous drivers combine to produce a sine-wave difference frequency propagating in an isotropic nonlinear medium, essentially without sidebands or reverberations. Its pattern has a main lobe approximately equal to that of the high frequency drive, but devoid of sidelobes. The level of the propagating difference frequency is proportional to both the product of the two fundamental drive levels and to the square of the desired value of difference frequency.
368. M. I. Dykman *et al.*, "Noise-enhanced heterodyning in bistable systems." *Phys. Rev. E*, 49(3), Mar. 1994, p. 1935-1942
369. (a) V. S. L'vov and L. A. Prozorova, "Spin Waves Above the Threshold of Parametric Excitation," in (b) A. S. Borovik-Romanov and S. K. Sinha, Eds., *Spin Waves and Magnetic Excitations*, North-Holland, Amsterdam, 1988.

370. Gurevich and Melkov, {232c}. The authors treat high **frequency** processes, i.e., oscillations and waves, in magnetically ordered substances, including ferromagnetic and antiferromagnetic resonances, spin waves, nonlinear processes, and high frequency manifestations of **interactions** between the magnetic system and other systems of magnetically **ordered** substances (crystal lattice, charge carriers). The treatment is classical except that a quantum mechanical approach is used in the study of relaxation processes, which determine the energy losses of magnetic oscillations and waves. Experimental results but not techniques are included. Self-oscillation and self-oscillation criteria are on p. 279.

**371.** (a) G. S. Kandaurova and A. E. Sviderskii, "Observation of autowave state and stable dynamic structures in multidomain magnetic films," *Sov. Tech. Phys. Lett.*, 14(5), May 1988, p. 346-347; (b) V. S. L'vov, {29c}.

372. Richard T. Hammond, "New fields in general relativity," *Contemp. Phys.*, 36(2), 1995, p. 103-114.

373. (a) J. Baugh et al., *Science*, Vol. 294, 16 Nov. 2001, p. 1505. For a simpler synopsis of the paper, see (b) Warren S. Warren, "Multidimensional Symmetry in a Three-Dimensional World," *Science*, Vol. 294, 16 Nov. 2001, p. 1475-1476.

374. E.g., see Howard R. Johnson, "Permanent Magnet Motor." U.S. Patent No. 4.151.431. Apr. 24. 1979.

**375.** Howard Johnson, private communication, January 2002.

376. In magnetics, multi-valued potentials (and hence the possibility **for** nonconservative fields) arise naturally in the theory, but are considered a nuisance to be eliminated or "averaged away" by magnetics engineers. E.g., see (a) Z. Ren, "A 3D vector potential formulation using edge element for electrostatic field computation," *IEEE Trans, on Magnetics*, **31(3)**, May 1995, p. 1520-1523; (b) — "New technique for solving three-dimensional multiply connected eddy-current problems." *IEEProc*, 137A(3), May 1990, p. 135-140; (c) J. C. Verite, "Calculation of multivalued potentials in exterior regions," *IEEE Trans, on Magnetics*, **Vol. MAG-23(3)**, May 1987, p. 1881-1887. Amazingly, these and other similar methods are directed into converting the multivalued potential into single-valued regions by a process of multiple, highly selected cuts. In other words, the real attempt is to eliminate the multivalued aspect, in which case the theorists are in fact simply eliminating the asymmetrical

self-regauging provided by the multivalued potential and hence are discarding the ability to use multivalued potentials in true overunity processes.

377. (a) Z. Badics, "Transient eddy current field of current forced three-dimensional conductors," *IEEE Trans, on Magnetics*, 28(2), Mar. 1992, p. 1232-1234; (b) R. Albanese and G. Rubinacci, "Magnetostatic field computations in terms of two component vector potentials," *Int. J. for Numerical Methods in Engineering*, Vol. 29, 1990, p. 515-532; (c) Bearden, {214f}: (d) P. Hammond and T. D. Ssiboukis, "Dual finite-element calculations for static electric and magnetic fields," *IEEProc. A*, 130(3), 1983, p. 105-111; (e) P. R. Kotiuga, "On making cuts for magnetic scalar potentials in multiply connected regions," *J. Appl. Phys.*, 61(8), 1987, p. 3916-3918; (f) J. Penman and J. R. Fraser, "Complementary and dual energy finite element principles in magnetostatics," *IEEE Trans, on Magnetics*, 18(2), 1982, p. 319-323; (g) E. A. Tolkachev and Ya. M. Shnir, "Non-trivial topology effects in the interaction of a monopole with a line current," *Phys. Lett. A*, 155(8, 9), May 27, 1991, p. 464-466.

378. (a) Feynman, {7}, Vol. II, Chapter 37; (b) T. Ambrose, R. L. Sommer, and C. L. Chien, "Angular Dependence of Exchange Coupling in Ferromagnetic/Antimagnetic Bilayers," *Phys. Rev. B*, Vol. 56, 1997, p. 83; (c) H. Sang, Y. W. Du, and C. L. Chien, "Exchange Coupling in  $\text{Fe}_3\text{O}_4/\text{Ni}_81\text{Fe}_{19}$  Bilayers: Dependence on Antiferromagnetic Layer Thickness," *J. Appl. Phys.*, Vol. 85, 1999, p. 4931.

379. V. A. Tulin, "Nuclear Spin Waves in Magnets," *Fis. Niskikh Temp.*, Vol. 5, 1979, p. 965-993 [in Russian].

380. Sweet and Bearden, {29a}.

381. (a) Kenneth R. Shoulders, U.S. Patent # 5,153,901; (b) — "Energy Conversion Using High Charge Density," U.S. Patent # 5,018,180, May 21, 1991; (c) — "Energy Conversion using High Charge Density," U.S. Patent No. 5,123,039, 1992; (d) — U.S. Patents 5,054,046 and 5,054,047, 1991; (e) — "Circuits Responsive To and Controlling Charged Particles," U.S. Patent 5,148,461, 1992; (f) — and Steve Shoulders, "Observations on the Role of Charge Clusters in Nuclear Cluster Reactions," *J. New Energy*, 1(3), Fall 1996, p. 111-121.

382. (a) Paulo N. Correa and Alexandra N. Correa, "Pulsed Abnormal Glow Discharge Technology," *Infinite Energy*, 2(7), Mar./Apr. 1996, p.

18-21; (b) — "Other Applications of the PAGD Technology Besides Energy Conversion," *ibid.*, p. 22-27; (c) — "Electrochemical Transduction of Plasma Pulses," U.S. Patent No. 5,416,391, May 16, 1995; (d) "Energy Conversion Systems," U.S. Patent No. 5,449,989, Sept. 12, 1995; (e) — "Direct Current Energized Pulse Generator Utilizing Autogenous Cyclical Pulsed Abnormal Glow Discharges," U.S. Patent 5,502,354, Mar. 26, 1996.

383. In 1935, Prileshajewa showed that there is an energy difference as much as 1.1 v between the exciting light and the fluorescence of aniline vapor. This added energy is attributed to additions from the internal energy of the molecule. Thus, anti-Stokes emission has been validated as a COP>1.0 mechanism since at least 1935. For our purposes, replenishment of the internal energy of the molecule must be obtained from the local active vacuum; else one simply has the standard optical cooling process which cools the gas.

384. E.g., see J. K. Brasseur et al., "Coherent Anti-Stokes Emission in a Continuous Wave Raman Laser in H<sub>2</sub>," carried on website location <http://www.physics.montana.edu/optics/jlc/Anti-Stokes.pdf>.

385. For a typical study, see J. Silver et al., "Studies on anti-Stokes emission from metal oxides (doped with Er<sup>3+</sup> and Yb<sup>3+</sup>) stimulated by 632.8 nm laser excitation," *6th Int. Conf. Phosphors and Display Tech.*, San Diego, California, 2000.

386. For a typical paper of hundreds on the subject, see C. Zander and K. H. Drexhage, "Cooling of a Dye Solution by Anti-Stokes Fluorescence," in *Advances in Photochemistry*, edited by D. C. Neckers, D. H. Volman, and G. von Bulau; Wiley, New York, 1995.

387. (a) Antoine Priore, "Method of producing radiations for penetrating living cells," U.S. Patent No. 3,280,816, Oct. 25, 1966; (b) — "Apparatus for producing radiations penetrating living cells," U.S. Patent No. 3,368,155, Feb. 6, 1968. For an explanation, see (c) T. E. Bearden, "The Porthole Briefing," <http://www.cheniere.org>.

388. Thomas Valone, "Future Energy Technologies," *J. New Energy*, 5(2), Fall 2000, p. 41-46; summary is quoted from p. 44-45.

389. Shang-Xiang Jin and Hal Fox, "Characteristics of High-Density Charge Clusters: A Theoretical Model," *J. New Energy*, 1(4), Winter 1996, p. 5-20.

390. Shoulders, {381a-381e}.
391. Ken Shoulders, "Permittivity transitions," *J. New Energy*, 5(2), Fall 2000, p. 121-137.
392. *Ibid*, p. 122.
393. *Ibid*, p. 122.
394. K. Shoulders and S. Shoulders, {381 f}.
395. Harold L. Fox, "Energy for the Future: High-Density Charge Clusters," *Modern Nonlinear Optics*, Second Edition, edited by M. W. Evans, Wiley, New York, 2001, Part III, p. 623-653.
396. See (a) Art Rosenblum, "Randell Mills — New Energy and the Cosmic Hydrino Sea," *Infinite Energy*, 3(17), Dec. 1997-1998, p. 21-34. Also see (b) Randell Lee Mills, "Energy/Matter Conversion Methods and Structures," Australian Patent No. 668678, Nov. 20, 1991. Particularly see (c) Eugene Mallove, "Dr. Randell Mills and the Power of BlackLight," *Infinite Energy*, 2(12), Jan.-Feb. 1997, p. 21, 35, 41.
397. Randell Mills *et al.*, "Lower-Energy Hydrogen Methods and Structure," U.S. Patent No. 6,024,935, Feb. 15, 2000. Some 60 pages, and an astounding 499 claims. For the patent, an independent verification was performed by Johannes Conrads, Institute for Low Temperature Plasma Physics at the Ernst Moritz Arndt University in Greifswald, Germany.
398. Randell L. Mills, "The Grand Unified Theory of Classical Quantum Mechanics," [www.blacklightpower.com/book/shtml](http://www.blacklightpower.com/book/shtml).
399. (a) Randell L. Mills *et al.*, "Identification of Compounds Containing Novel Hydride Ions by Nuclear magnetic Resonance Spectroscopy"; (b) — "Spectroscopic Identification of Novel Catalytic-Reaction of Atomic Hydrogen and the Hydride Ion Products"; (c) — "Black Light Power Technology: A New Clean Energy Source with the Potential for Direct Conversion to Electricity," presented to the Intl. Conf. On Global Warming and Energy Policy, Nov. 26-28, 2000 and to the National Hydrogen Association Meeting, March 6-8, 2001; (d) — Plasma Power Source Based on a Catalytic Reaction of Atomic Hydrogen"; (e) R. M. Mayo and R. L. Mills, "Direct Plasmadynamic Conversion of Plasma Thermal Power to Electricity for Microdistributed Power Applications," *40th Ann. Power Sources Conf. Proc*, June 10-13, 2002; (f) R. Mills *et al.*, "Novel Catalytic Reaction as a Potential New Energy Source," 223rd

ACS National Meeting, Orlando, Florida, Apr. 6-11, 2002; (g) — "Novel alkali and Alkaline Earth Hydrides for High Voltage and High Energy Density Batteries," *Proc. 17th Ann. Battery Conf. On Appl. And Advances, Calif. State Univ., Long Beach, CA, Jan. 15-18* (in press); (h) - "Synthesis of Diamond Films from Solid Carbon"; (i) Mills and Ray, "Spectral Emission of Fractional Quantum Energy Levels of Atomic Hydrogen from a Helium-Hydrogen Plasma and the Implications for Dark Matter," *Int. J. Hydrogen Energy*, 27(3), 2002, p. 301-322.

400. Peter D. Zimmerman, "An Analysis of Theoretical Flaws in So-Called Classical Quantum Mechanics and of Experimental Evidence against CQM," 2001.

401. Bearden, {222b}, p. 674.

402. E.g., it yields the excess deuterium, tritium, and alpha particles; see Bearden, {17}.

403. (a) Bearden, {222b}; Bearden, {15}.

404. (a) "Ion Cyclotron and Converter and Radio Power Microwave Generator," International Pub. No. WO 01/21300 A2, 29 March 2001; (b) "Ion Cyclotron Power Converter and Radio and Microwave Generator," International Pub. No. WO 01/22472, 29 March 2001. Both filed with World Intellectual Property Organization.

405. But see Samuel D. Harper. "The energy dissipated in a switch," *Am. J. Phys.*, 56(10), Oct. 1988, p. 866-889. Unless special attention and effort is paid, switches can indeed consume a great deal of energy! As Harper points out, it can be a substantial fraction of the energy transfer in the circuit. In a capacitive loaded circuit this is especially true. One should consider very efficient switching such as optically coupled switching arrangements.

406. (a) F. Heinrich, "Entropy change when charging a capacitor: A demonstration experiment," *Am. J. Phys.*, 54(8), 1986, p. 742-44. For an expanded discussion, see (b) I. Fundaun, C. Reese, and H. H. Soonpaa, "Charging a capacitor," *Am. J. Phys.*, 60(11), Nov. 1992, p. 1047-1048. Also see (c) Tyler A. Abbott and David J. Griffiths, "Acceleration without radiation." *Am. J. Phys.*, 53(12), Dec. 1985, p. 1203-1211. An extended charge can accelerate without radiating, under specified conditions.

407. (a) Davis, {360}. It would appear that a sine wave across this resistor may generate a **rhythmic** variation in what is called "internal

energy"; i.e., stress energy inside the system, hence stress energy in the associated vacuum. Since this is analogous to a sound wave consisting of rarefaction and expansion, it is a method of generating a longitudinal EM wave. This may also be involved also in the Fogal semiconductor. For a discussion of internal forces, which occur in equal and opposite pairs and are quite different from the resultant of forces, see (b) Chen, {358}, p. 372 and passim.

408. See Hsu-Chieh Yeh, "Remark on the second law of thermodynamics," *Am. J. Phys.*, 52(8), Aug. 1984, p. 720-723. As an example, from the common charge or dipole at constant temperature, we can indeed receive and take electrical energy because the charge (as a set of composite dipoles) and the dipole are not in 3-space energy flow equilibrium. Instead, they constantly receive virtual EM energy from the active vacuum, transduce it into 3-space EM energy, and continuously emit **that** energy in all directions — all at constant temperature. When we consider the supersystem of the charge-system and its environment, it is in disequilibrium and hence exhibits the effect pointed out by Yeh.

409. Yeh, {408}. Particularly see the illustration on p. 721.

410. Gabriel Laufer, "Work and heat in the light of (thermal and **laser**) light," *Am. J. Phys.*, Vol. 51, 1983, p. 42.

411. (a) Paulo N. Correa and Alexandra N. Correa, "A Modified Orgone Accumulator (HYBORAC) as a Drive for a Low Delta-T **Stirling** Engine, Part 1," *Infinite Energy*, 7(41), 2002, p. 23-29; (b) — "Orgone Accumulator Drive (HYBORAC) for Low Delta Stirling Motors, video presentation, ABRI Media Production.

412. Paulo N. Correa and Alexandra N. Correa, *Introduction to Experimental Aetherometry*, Vols. 1 and 2, 2001. Summaries of these **two** volumes may be freely downloaded from <http://www.aetherometry.com>

413. Paulo N. Correa and Alexandra N. Correa, "A Modified Orgone Accumulator (HYBORAC) as a Drive for a Low Delta-T Stirling **Engine** Part II." *Infinite Energy*, 7(42), 2002 (in press)

414. Eugene F. Mallove, "Demonstrating Aether Energy," *Infinite Energy*, 7(41), 2002, p. 6-8.

415. As quoted by Mallove, *ibid.*, p. 7.

416. Feynman, {7}, Vol. II, p. 1-3. Emphasis in original.



417. Mallove, {414}, p. 7.
418. J. M. Aguirregabiria, A. Hernandez, and M. Rivas, "Surface charges and energy flow in a ring rotating in a magnetic field." *Am. J. Phys.*, 64(7), July 1996, p. 892-895.
419. F. Herrmann, "The unexpected path of the energy in a moving capacitor," *Am. J. Phys.*, 61(2), Feb. 1993, p. 119-121.
420. Wang and Chung, {33}.
421. Mike LaPointe, "Antimatter Production at a Potential Boundary," presented at the AIAA Joint Propulsion Conference, Breakthrough Propulsion Physics Session #1, July 9, 2001.
422. E.g., (a) Charles Kittel, *Introduction to Solid State Physics*, Seventh Edition, Wiley, New York, 1996 in various chapters contains excellent introductions to a more in-depth view of magnetic phenomena. A very useful book, written with clarity is (b) B. D. Cullity, *Introduction to Magnetic Materials*, Addison-Wesley, Reading, MA, 1972. For nuclear effects, (c) A. Abraham, *Nuclear Magnetism*, Oxford. 1961 is still excellent and quite comprehensive.
423. (a) Particularly see the lay overview by Philip Ball, "Meet the spin doctors...", *Nature*, Vol. 404, 2000, p. 918-920. This article deals with spin-injection from magnetic semiconductors. In addition to up and down, electron spin also has an additional degree of freedom called "color"; see (b) "Colourful electrons solve puzzle of ferromagnetism," *Physics World*, 14(7), July 2001; (c) also see the accompanying article by Fu Chun Zhang.
424. Stanislaw Bednarek, "Self-powered magnetohydrodynamic motors," *Am. J. Phys.*, 64(1), Jan. 1996, p. 90-92.
425. In a true superconducting system, it is possible to keep the current moving around in a resistance-free conductor indefinitely. However, no net work can be produced by the system, and in fact when one counts the energy one inputs to maintain the extremely low temperature of the environment, then to maintain the supersystem in such "**indefinite current circulation**" one has to continuously input energy to cool the **system**. On the other hand, an electron in an atom, orbiting the nucleus, is in **net** equilibrium on its path, so it will maintain its orbit indefinitely until perturbed sufficiently to break loose.

426. (a) Badics, {377a};(b) P. Hammond and J. Penman, "Calculation of inductance and capacitance by means of dual energy principles," *IEE Proc.*, 123(6), 1976, p. 554-559; (c) Hammond and Ssiboukis, {377d}; (d) Yongzhong Huo, "A classification of thermodynamical potentials for two-variable transition systems," *Meccanica* [Netherlands], 30(5), Oct. 1995, p. 475.494; (e). Kotiuga, {377e}; (f) J. N. Murrell and S. Carter, "Approximate single-valued representations of multivalued potential energy surfaces," *J. Phys. Chem.*, 88(21), Oct. 11, 1984, p. 4887-4891; (g) Penman and Fraser, {377f}; (h) Ren, {376a}; (i) Z. Ren, "Solving 3D static field problems by dual formulations using potential variables," *2nd Int. Workshop on Elec. and Magn. Fields*, Leuven, Belgium, May 1994; (j) Ren, {376b}; (k) Verite, {376c}; (l) V. Vittal, "A generalized procedure to obtain first integrals for non-conservative dynamical systems: Application to power systems," *IEEE ISCAS '89*, 1989, p. 1984-1987.
427. G. W. O. Howe, "Effect of Torsion on a Longitudinally-Magnetized Iron Wire," *Wireless Engineer*, 29(344), May 1952, p. 115-117.
428. Harry E. Burke, *Handbook of Magnetic Phenomena*, Van Nostrand, New York, 1985. This is a one-of-a-kind handbook on a great number of magnetic effects and phenomena.
429. Cullity, {422b}.
430. As examples: (a) Barrett, {345}; (b) Gurevich and Melkov, {232c}; (c) William Weltner, Jr., *Magnetic Atoms and Molecules*, Dover, Mineola, NY, 1989; (d) Giorgio Bertotti, *Hysteresis in Magnetism*, Academic Press, New York, 1998; (e) L'vov, {29c}; (f) Sidney Platt, *Magnetic Amplifiers: Theory and Application*, Prentice Hall, Englewood Cliffs, N.J., 1958; (g) Maciej J. Ogorzalek, *Chaos and Complexity in Nonlinear Electronic Circuits*, World Scientific, New Jersey, 1997; (h) Jammer, {1b}; (i) Borovik-Romanov and Sinha, Eds, {369b}; (j) Paul Davies, ed., {160f}; (k) G. I. Shipov, *A Theory of Physical Vacuum: A New Paradigm*, Moscow, 1994; (l) Nicolis and Prigogine, {255b}; (m) Richard Feynman, *Quantum Electrodynamics*, 1961, 1963; (n) V. I. Fushchich and A. G. Nikitin, *Symmetries of Maxwell's Equations*, D, Reidel, 1987; (o) Mandl and Shaw, {19}; (p) M. W. Evans, Ed., *Modern Nonlinear Optics*, Second Edition, 3 vols., Wiley, 2001; (q) Robert C. O'Handley, *Modern Magnetic Materials: Principles and Applications*, Wiley, New York, 2000; (r) Sachs, {126a}.

431. As examples: (a) Lindsay and Margenau, {114}; (b) Richard P. Feynman, *The Character of Physical Law*, MIT Press, Cambridge, 1965; (c) Feynman, {7}; (d) Ilya Prigogine, *The End of Certainty: Time, Chaos, and the New Laws of Nature*, Free Press, New York, 1996, 1997; (e) Mendel Sachs, *Einstein Versus Bohr: The Continuing Controversies in Physics*, Open Court Publishing Company, 1988.
432. For those unfamiliar with magnetics and the exchange force(s), see H. J. Gray and Alan Isaacs, *A New Dictionary of Physics*, second edition, 1976 printing, *ibid.*, p. 194 for a precise definition. The force from the sudden exchange of charge is known as the *Heisenbergforce*. That due to the exchange of spin direction is known as the *Bartlettforce*. The force associated with exchange of both spin and charge is known as the *Majoramaforce*. Quoting: "These exchange forces may be interpreted as being due to the continual emission and absorption of virtual particles that carry the shared property from one particle to another. The exchange of virtual hadrons between interacting particles of the atomic nucleus is intimately involved in nuclear exchange forces.
433. Feynman, {7}, Vol. II, Chapter 37 covers magnetic materials including exchange forces, spins, and spin effects.
434. *The Encyclopedia of Physics*, Robert M. Besancon (editor), Second Edition, Van Nostrand Reinhold, New York, 1974, p. 518.
435. Cullity, {422b}. p. 132.
436. Kittel, {422a}, p. 443 (footnote 1).
437. Lindsay and Margenau, {114}, p. 216-217.
438. *Ibid.*, p. 213.
439. *Ibid.*, p. 215.
440. *Ibid.*, p. 214.
441. T. D. Lee, "Space Inversion, Time Reversal and Particle-Antiparticle Conjugation," *Physics Today*, 19(3), Mar. 1966, p. 23.
442. Lee, {73}, p. 187-188.
443. Romer, {84}.
444. Kenneth D. Moore, "Testing of a Johnson Magnetic Gate," *Explore*, 9(6), 2000, p. 70-75. Also available on [www.cheniere.org](http://www.cheniere.org).

445. (a) Raymond J. Radus and William G. Evans, "Apparatus Responsive to Direct Quantities," U.S. Patent #2,892,155, Jun. 23, 1959; (b) R. J. Radus, "Permanent-Magnet Circuit using a 'Flux-Transfer' principle," *Engineers' Digest*, 24(6), June 1963, p. 86; (c) (anon.), "On-Off Permanent Magnet with a Memory," *Electronic Equipment Engineering*, 11(4), Apr. 1963, p. 22, 26.
446. "Human fly has magnetic sole," *Electrical Engineering*, Apr. 1963, p. 294.
447. Malcolm McCaid, *Attraction and Repulsion*, Oliver and Boyd Ltd., 1967 has an entire chapter on switching magnets, and has two photos of an engineer hanging upside down and walking on the underside of an elevated steel beam, wearing the Radus magnetic boots.
448. For a description of "shuffler" boots, see A. W. Hangar and A. A. Rosener, "The use of permanent magnets in zero-gravity mobility and restraint 'footware' concept," *IEEE Trans, on Magnetics*, Vol. MAG-6, No. 3, Sep. 1970, p. 464-467. These crude shuffler boots are quite a contrast to the elegant Westinghouse/Radus stepping boots earlier developed and used.
449. Burke, {428}.
450. David Scott, "Magnetic "Wankel" for electric cars," *Popular Science*, June 1979, p. 90-91.
451. E.g., (a) John R. Wiegand, "Bistable Magnetic Device," U.S. Patent No. 3,820,090, June 25, 1974; (b) — "Asymmetric Bistable Magnetic Device," U.S. Patent No. 3,866,193, Feb. 11, 1975; (c) - "Pulse Generation by Changing Magnetic Field," U.S. Patent No. 4,309,628, Jan. 5, 1982; (d) — "Pulse Generator Using Read Head with Wiegand Wire," U.S. Patent No. 4,263,523, April 21, 1981; (e) - "Switchable Magnetic Device;" U.S. Patent No. 4,247,601, Jan. 27, 1981; (f) — "Method of Manufacturing Bistable Magnetic Device," U.S. Patent No. 3,892,118, July 1, 1975; (g) — "Multiple Pulse Generator;" U.S. Patent No. 3,793,532, Feb. 19, 1974; (h) — and John E. Opie, "Pulse Generator with Shaped Magnetic Field," U.S. Patent No. 4,484,090. Nov 20, 1984.
452. Kawai, {31}.
453. John C. Bedini, "Device and Method of a Back EMF Permanent Electromagnetic Motor Generator," U.S. Patent No. 6,392,370, May 21.

2002. Uses a regauging process for capturing available back **EMF** electromagnetic energy in the system. The available energy may be captured and used to re-energize the battery, and/or sent in another direction to be used as useful work, or dissipated in the system.

454. See {445c}, p. 22, 26. Quoting: "*The circuit differs from ordinary permanent magnets in three ways: (1) It exerts strong magnetic force at one end while exerting hardly any at the other, (2) the strong and weak magnetic poles can be switched end-for-end easily and at will, thus in effect turning the magnetism on and off, and (3) it remembers its direction of greatest magnetic pull indefinitely.*"

455. Burke, {428}, p. 250.

456. Deffeyes, {342}.

457. Stuart Young, *Nature*, Vol. 414, 29 Nov. 2001, p. 487.

458. Evans, {137b}, p. 84.

459. M. W. Evans and S. Jeffers, "The Present Status of the Quantum Theory of Light," in *Modern Nonlinear Optics*, Second Edition, 3 Vols., edited by M. W. Evans, Wiley, 2001, Vol. 3, p. 150.

460. Clarke, {55}, p. 38.

461. Patrick, Bearden, Hayes, Moore, and Kenny, {37}. A second patent is pending, and two more are in preparation.

462. Bearden, {222b}.

463. Evans et al, {38b, 38c}.

464. T. E. Bearden, James C. Hayes, James L. Kenny, Kenneth D. Moore, and Stephen L. Patrick, "The Motionless Electromagnetic Generator: Extracting Energy from a Permanent Magnet with Energy-Replenishing from the Active Vacuum," Sept. 2000, carried on restricted DoE website <http://www.ott.doe.gov/electromagnetic/>. A search on the internet will turn up other sources where the paper can be downloaded.

465. (a) Evans et al., "The Aharonov-Bohm Effect as the Basis of Electromagnetic Energy Inherent in the Vacuum," *Found. Phys. Lett.*, 2002, (in review); (b) — "Derivation of the B(3) Field and Concomitant Vacuum Energy Density from the Sachs Theory of Electrodynamics," *Found. Phys. Lett.*, 14(6), Dec. 2001, p. 589-593; (c) — "Operator Derivation of the **Gauge** Invariant **Proca** and Lehnert Equations:

Elimination of the Lorenz Condition," *Found. Phys.*, 30(7), 2000, p. 1123-1130; (d) — "Runaway Solutions of the Lehnert Equations: The Possibility of Extracting Energy from the Vacuum," *Optik*, 111(9), 2000, p. 407-409; (e) — "The Effect of Vacuum Energy on the Atomic Spectra," *Found. Phys. Lett.*, 13(3), June 2000, p. 289-296; (f) Evans et al., {113}; (g) — "Derivation of the Lehnert Field Equations for Gauge Theory in Vacuum: Space Charge and Current," *Found. Phys. Lett.*, 13(2), Apr. 2000, p. 179-184;(h)Bearden, {222b}.

466. Details are on Jean-Louis Naudin's website, in the section dealing with the MEG, which is <http://jnaudin.free.fr/html/megv21.htm#megstat>.

467. For an introduction to the field and its literature, see J. Anandan, J. Christian, and K. Wanelik, "Resource letter GPP-1: Geometric phases in physics," *Am. J. Phys.*, Vol. 65, 1977, p. 180-185.

468. A discussion by Feynman of the Aharonov-Bohm effect is given in Feynman, {7}, "15-5: The vector potential and quantum mechanics," p. 15-8 to 15-14.

469. A similar phase change also is induced outside the localized presence of an electrostatic scalar potential  $\phi$ . See Feynman, {7}, p. 15-10. Quoting: "...the effect of an electrostatic field is to produce a phase change given by the negative of the time integral of the scalar potential  $\phi$ "

470. Ya. M. Blanter, C. Bruder, R. Fazio, and H. Schoeller, "Aharonov Bohm-type Oscillations of Thermopower in a Quantum-dot Ring," *Phys Rev. B*, Vol. 55, 1997, p. 4069 typify the kind of "power" considerations that have been analyzed in the past. Only a minuscule thermopower treatment is considered.

471. S. Pancharatnam, "Generalized theory of interference, and its applications," *Proc. Indian Ac ad. Sci.*, Vol. A44, 1956, p. 247-262.

472. See Nahin, {62}, p. 225. Quoting: "*J. J. Waterston's paper on the kinetic theory of gases, in 1845, was rejected by the Royal Society of London. One of the referees declared it to be 'nothing but nonsense, unfit even for reading before the Society.'*... "*Waterston's dusty manuscript was finally exhumed from its archival tomb forty years later, because of the efforts of Lord Rayleigh...*"

473. Aharonov and Bohm, {344a, 344b}.

474. R. G. Chambers, "Shift of an electron interference **pattern** by enclosed magnetic flux," *Phys. Rev. Lett.*, Vol. 5, July 1960, p. 3-5.
475. A. Tonomura *et al.*, "Observation of Aharonov-Bohm effect by electron holography," *Phys. Rev. Lett.*, Vol. 48, 1982, p. 1443-1446.
476. A. Tonomura *et al.*, "Evidence for Aharonov-Bohm effect with magnetic field completely shielded from electron wave," *Phys. Rev. Lett.*, Vol. 56, 1986, p. 792-795. In the latter paper, the magnetic fields were completely and painstakingly shielded from the electron wave in a very careful experiment. The experiment demonstrated the expected relative phase shift as well as direct evidence for flux quantization. This was a definitive experiment clearly proving the Aharonov-Bohm effect. In 1999, Tonomura was awarded the Franklin Institute Award for this definitive proof of the Aharonov-Bohm effect.
477. M. V. Berry, *Proc. R. Soc. Lond. A*, Vol. 392, 1984, p. 45.
478. R. A. Webb, S. Washburn, C. P. Umbach, and R. B. Laibowitz, "Observation of  $h/e$  Aharonov-Bohm oscillations in normal-metal rings," *Phys. Rev. Lett.*, Vol. 54, 1985, p. 2696-2695.
479. B. Schwarzschild, "Currents in Normal-Metal Rings Exhibit Aharonov-Bohm Effect," *Phys. Today*, Vol. 39, Jan. 1986, p. 17-20.
480. Y. Aharonov and J. Anandan, "Phase change during a cyclic quantum evolution," *Phys. Rev. Lett.*, Vol. 58, 1987, p. 1593-1596.
481. (a) V. Chandrasekhar *et al.*, *Phys. Rev. Lett.*, Vol. 55, 1985, p. 1610; (b) S. Datta *et al.*, *Phys. Rev. Lett.*, Vol. 55, 1985, p. 2344; (c) S. N. M. Ruijsenaars, "The Aharonov-Bohm Effect and Scattering Theory," *Ann. Phys.*, Vol. 146, 1983, p. 1-34.
482. S. Olariu and I. Iovitzu Popescu, "The Quantum Effects of Electromagnetic Fluxes," *Rev. Mod. Phys.*, 57(2), Apr. 1985, p. 339-436.
483. (a) R. Bhandari, "Polarization of light and topological phases," *Phys. Repts.*, Vol. 281, 1997, p. 1-64; (b) — and J. Samuel, "Observation of topological phase by use of a laser interferometer," *Phys. Rev. Lett.*, Vol. 60, 1988, p. 1211-1213; (c) R. Y. Chiao *et al.*, "Observation of a topological phase by means of a Mach-Zehnder interferometer," *Phys. Rev. Lett.*, Vol. 60, 1988, p. 1214-1217; (d) T. Bitter and D. Dubbers, "Manifestation of Berry topological phase in neutron spin rotation," *Phys. Rev. Lett.*, Vol. 59, 1987, p. 251-254; (e) Y. Hasegawa *et al.*, "Geometric

phase in coupled neutron interference loops," *Phys. Rev. A*, Vol. 53, 1996, p. 2486-2492; (f) A. G. Wagh *et al.*, "Experimental separation of geometric and dynamical phases using neutron interferometry," *Phys. Rev. Lett.*, Vol. 78, 1997, p. 755-759; (g) D. Suter, K. T. Mueller, and A. Pines, "Study of the Aharonov-Anandan quantum phase by NMR interferometry," *Phys. Rev. Lett.*, Vol. 60, 1988, p. 1218-1220; (h) D. Loss and P. M. Goldbart, "Persistent currents from Berry's phase in Mesoscopic systems," *Phys. Rev. B*, Vol. 45, 1992, p. 13544-13561; (i) C. A. Mead, "The geometric phase in molecular systems," *Rev. Mod. Phys.*, Vol. 64, 1992, p. 51-85; (j) J. H. Hannay, "Angle variable holonomy in adiabatic excursion of an integrable Hamiltonian," *J. Phys. A*, Vol. 18, 1985, p. 221-230; (k) Y. Aharonov *et al.*, "Aharonov-Bohm Type Forces Between Magnetic Fluxons," Hewlett Packard Report HPL-BRIMS-97-24, Oct. 1997.

484. (a) F. V. Gubarev and V. I. Zakharov, "The Berry Phase and Monopoles in Non-Abelian Gauge Theories," *Internat. J. Mod. Phys. A*, Vol. 17, 2002, p. 157-174; (b) J. M. Robbins, "Topological Phase Effects," Hewlett-Packard Labs Technical Report HPL-BRIMS-97-03, Jan. 31, 1997; (c) E. Sjoqvist, "Anandan-Aharonov-Casher oscillations in a simply connected region," *Phys. Lett. A*, Vol. 270, 2000, p. 10; (d) E. Sjoqvist *et al.*, "Geometric phases for mixed states in interferometry," *Phys. Rev. Lett.*, Vol. 85, 2000, p. 2845; (e) D. J. Thouless, *Topological Quantum Numbers in Nonrelativistic Physics*, World Scientific, Singapore, 1998; (f) J. Mickelsson, "Vacuum Polarization and the Geometric Phase: Gauge Invariance," *J. Math. Phys.*, Vol. 39, 1998, p. 831-837; (g) W. T. Lee *et al.*, "Scalar Aharonov-Bohm Effect with Longitudinally Polarized Neutrons," *Physica B*, Vol. 241-243, 1998, p. 216; (h) A. Cimmino *et al.*, "High Precision Measurement of the Topological Aharonov-Casher Effect with Neutrons," *Nuclear Instr. and Methods A*, Vol. 440, 2000, p. 579; (i) Ali Mostafazadeh, *Dynamical Invariants, Adiabatic Approximation and the Geometric Phase*, Nova Science, 2001.

485. E.g., see (a) M. W. Evans and L. B. Crowell, *Classical and Quantum Electrodynamics and the B(3) Field*, World Scientific, Singapore, 2001; (b) M. W. Evans, *0(3) Electrodynamics*, Vol. V of *The Enigmatic Photon*, Kluwer, Dordrecht, 1999.

486. Bearden, {12}.

487. Fradkov and Pogromsky, {364}. The quote is from p. 359-360.



488. (a) Bearden, {38a}, (b) Bearden *et al.*, {464}, (c) Evans *et al.*, {38b}, (d) Evans *et al.*, {38c},
489. Seife, {184}.
490. I. J. R. Aitchison, "Nothing's Plenty: The Vacuum in Modern Quantum Field Theory," *Contemp. Phys.*, 26(4), 1985, p. 339, 360.
491. *Ibid.*, p. 372.
492. Robert Neill Boyd, "Black Holes and Negative Energy", carried on Internet website <http://www.rialian.com/rnboyd/blackholcs-negative.htm>.
493. Roger Penrose, *The Emperor's New Mind*. Penguin Books, 1991, p. 210.
494. Stephen Hawking, per Zebrowski, {2}.
495. Isaac Newton, *Philosophiae Naturalis Principia Mathematica*, 1687.
496. Quoted from D. W. G. Ballentine and D. R. Lovett, *A Dictionary of Named Effects and Laws in Chemistry, Physics, and Mathematics*, Fourth Edition, Chapman and Hall, New York, 1980. p. 227.
497. Dirac, {249}.
498. See also (a) P.A.M. Dirac. "The quantum theory of the electron," *Proc. Roy. Soc. Lond. A*, 117(777), Jan. 2, 1928. p. 610-624; (b) — "The quantum theory of the electron, Part II," *ibid.*, 118 (779), Mar. 1, 1928, p. 351-361.
499. Georg Friedrich Bernhard Riemann, "Foundations of a general theory of functions of a single complex variable." Doctoral Thesis, 1851. In H. Weber, ed., *B. Riemann: Gesammelte Mathematische Werke*, 2nd Ed., paperback reprint, Dover, New York, 1953.
500. As pointed out by Charles W. Misner, Kip S Thorne and John Archibald Wheeler, *Gravitation*, W. H. Freeman and Company, San Francisco, 1973, p. 220.
501. Josephs, {172}.
502. Laithwaite, {172b}.
- 503.** Ernst Mach, *The Science of Mechanics*. 1912, Chapter 2, section 6.

504. This statement of Mach's principle is quoted from Ballentine and Lovett, {496}, p. 201.
505. Albert Einstein, "Die Grundlage der Allgemeinen Relativitätstheorie," ["The Foundation of the General Theory of Relativity,"] *Annalen der Physik*, Vol. 49, 1916, p. 769-822. (English translation in *The Principle of Relativity*, Methuen, NY, 1923.).
506. Misner, Thorne and Wheeler, {500}, p. 543.
507. A. Einstein, Appendix V to his *Relativity, The Special and the General Theory*, translated by Robert W. Lawson, Crown Publishers, New York, 1961, p. 155.
508. Theodor Kaluza, *Sitz. Preuss. Akad. Wiss.*, Vol. K1, 1921, p. 966. English translation, "On the Unification Problem of Physics," is in Lochlainn O'Raifeartaigh, *The Dawning of Gauge Theory*, Princeton University Press, Princeton, 1997, p. 53-58. Einstein had held Kaluza's paper since 1919 before recommending it for publication by the journal.
509. {a} Oskar Klein, *Zeit. f. Physik*. Vol. 37, 1926, p. 895. An English translation, "Quantum Theory and Five-Dimensional Relativity," is in Lochlainn O'Raifeartaigh, *The Dawning of Gauge Theory*, Princeton University Press, Princeton, 1997, p. 59-69. See also {b} Oskar Klein, *Nature*, Vol. 118, 1926, p. 319.
510. Sachs, {126a}.
511. Sachs, *ibid.*, quoted from the publisher's summation on the book jacket itself.
512. Mendel Sachs, "On Unification of Gravity and Electromagnetism and the Absence of Magnetic Monopoles," *IL Nuovo Cimento B*, Vol. **114**, 1999, p. 123.
513. (a) Evans et al., {233f}; (b) Evans et al., {233b}.
514. Misner, Thorne, and Wheeler, {500}.
515. Albert Einstein, *Relativity: the Special and General Theory*, translated by Robert W. Lawson, Crown Publishers, New York, 1961, fifteenth edition.
516. A. Einstein, H. A. Lorentz, H. Minkowski and H. Weyl, with **notes** by A. Sommerfeld, translations by W. Perrett and G. B. Jeffery, *The*

*Principle of Relativity*, Methuen and Company. Ltd., 1923. Also available in paperback from Dover.

517. (a) T. Townsend Brown, "A Method of and an Apparatus or Machine for producing Force or Motion, British Patent 300,311, Nov. 15, 1928; (b) — "Electrokinetic Apparatus," U.S. Patent # 2,949,550, Aug. 16, 1960; (c) — "Electrokinetic Transducer," U.S. Patent # 3,018,394, Jan. 23, 1962; (d) — "Electrokinetic Generator," U.S. Patent # 3,022,430, Feb. 20, 1962; (e) — "Electrokinetic Apparatus," U.S. Patent # 3,187,206, Jun. 1, 1965.

518. Jonathan W. Campbell, "Apparatus and Method for Generating Thrust Using a Two Dimensional, Asymmetrical Capacitor Module," U. S. Patent #6,317,310, Nov. 13,2001.

519. (a) Norman L. Dean, "System for Converting Rotary Motion into Unidirectional Motion," U.S. Patent # 2,886,976, May 19, 1959. See also (b) John W. Campbell, Jr., "Report on the Dean Drive," *Analog*, Sept. 1960; (c) — "Instrumentation for the Dean Drive," *Analog*, Nov. 1960; (d) — "Final Report on the Dean Drive," *Analog*, Dec. 1960. Also (e) G. Harry Stine, "Detesters, Phasers, and Dean Drives," *Analog*, Jun. 1976.

520. (a) Henry Wallace, "Method and Apparatus for Generating a Secondary Gravitational Force Field," U.S. Patent # 3,626,605, Dec. 14, 1971; (b) — "Method and Apparatus for Generating a Dynamic Force," U.S. Patent # 3.626.606. Dec. 14, 1971.

521. J. F. Woodward, "Method for Transiently Altering the Mass of Objects to Facilitate their Transport or Change their Stationary Apparent Weights", U.S. Patent #5,280,864, Jan. 25, 1994.

522. (a) J. F. Woodward, "A New Experimental Approach to Mach's Principle and Relativistic Gravitation," *Found. Phys. Lett.*, 3(5), 1990, p. 497-506; (b) — "Corrigendum: A New Experimental Approach to Mach's Principle and Relativistic Gravitation," *Found. Phys. Lett.*, 4(3), 1991, p. 299;(c) — "Measurements of a Machian Transient Mass Fluctuation,"<sup>1</sup> *Found. Phys. Lett.*, 4(5), 1991, p. 407-423; (d) -- "A Stationary Apparent Weight Shift from a Transient Machian Mass Fluctuation," *Found. Phys. Lett.*, 5(5), 1992, p. 425-442; (e) — Maximal Acceleration, Mach's Principle, and the Mass of the Electron," *Found. Phys. Lett.*, 6(3), 1993, p. 233-244; (f) — "Making the Universe Safe for Historians: Time Travel and the Laws of Physics," *Found. Phys Lett.*, 8(1). 1995, p. 1-39; (g) - "Erratum," *Found. Phys Lett.*, 8(3), 1995, p. 303; (h) - "Killing Time."

*Found. Phys. Lett.*, 9(1), 1996, p. 1-23; (i) — "Laboratory Test of Mach's Principle and Strong-Field Relativistic Gravity," *Found. Phys. Lett.*, 9(3), 1996, p. 247-293; (j) — "Twists of Fate: Can We Make Traversable Wormholes in Spacetime?," *Found. Phys. Lett.*, 10(2), 1997, p. 153-181; (k) — Mach's Principle and Impulse Engines: toward a Viable Physics of Star Trek?", presented at the NASA Breakthrough Propulsion Physics Workshop, Cleveland, Ohio, Aug. 12-14, 1997.

523. (a) Max Jammer, *Concepts of Mass, in Classical and Modern Physics*, Harvard University Press, Cambridge, MA, 1961. One also suggests the reading of Jammer, {1b}.

524. (a) Bearden, {15}, p. 11. One kilogram of mass represents  $17.053 \times 10^{50}$  switches per second of action  $\text{quanta}/(4 \cdot \text{PI})$  across the boundary of the mass, in a flux exchange between the mass region and its external environment. The acceleration force can be derived from the difference in "in-switching" and "out-switching" of action quanta (as the masses  $m_i$  of the system iteratively change between mass and masstime states). The paper, albeit crudely, derives Newton's three laws of motion in relativistic form and the square law of gravitation. It also indicates the mechanism (reaction) upon a mass that generates the mass's rate of progression through time. For a somewhat expanded treatment, see (b) T. E. Bearden, "Vacuum Engines and Priore's Methodology: The True Science of Energy Medicine," Parts I and II, *Explore*, 6(1), 1995, p. 66-76; 6(2), 1995, p. 50-62.

525. Today we would also point out that to first order time and mass have essentially the same energy density — i.e., they are both spatial energy compressed by  $c^2$ . So the "switches" of action quanta we used in 1973 may be taken to actually represent the time-charging and discharging, of a specific region of space. Rotation of time-energy from the time-domain into 3-space connection with a mass is a mass increase as well as a change of mass to masstime. Rotation of mass-energy out of 3-space back into the time domain (during photon emission) is a mass decrease, (a) Our paper, "Giant Negentropy..." {12}, proposing a solution to the source charge problem, argues that all 3-space EM energy comes from the time domain anyway and returns to it. The source charges normally absorb time-energy, and transduce it to 3-space EM energy or vice versa, but the 3-space energy radiated away is in expanded spatial energy form and not compressed into mass-energy. It is the very release of the  $c^2$  compression of the time-energy that is the "transduction" process to provide the **radiated**

spatial EM energy. But if mere rotation in 4-space is used without **that** expansion/transduction, then the time energy appears as mass. This is consistent with the mechanism we advanced for the flow of a mass  $m$  through time. Note that when a photon is "absorbed", the spatial energy component of the photon is in fact compressed into mass energy, slightly changing the mass. But when it is re-radiated, it is radiated in expanded or "spatial" EM energy form. Without the expansion and transduction, pure rotation of the compressed EM energy between the time domain and the 3-space domain provides the notion of "time-charging" and "time discharging". Indeed, the very anomalous phenomena occurring in radiation detectors in electrolyte experiments at China Lake, already provide direct evidence for just such time-charging, as pointed out in (b) Bcardcn, {17}.

526. E. R. Laithwaite, "Rack and pinion motors," *Electronics and Power*, Vol. 16, 1970, p. 251-252.
527. Of interest: (a) E. R. Laithwaite, "Unexplained phenomenon at Savoy Place," *Electronics and Power*, Oct. 1972, p. 360-362 recounts the discovery of a free energy device violating the second law of equilibrium thermodynamics; (b) Laithwaite, {526}, gives some particulars of the device; (c) — *All Things Are Possible: An Engineer Looks at Research and Development*, I\*PC Electrical-Electronic Press Ltd., Dorset House, London, 1976; (d) Laithwaite, {172b}; (e) — "Miles Walker — a pioneer at Met-Vick and UMIST," *Electrical Review*, 211(12), Oct. 15, 1982, p. 33-34; (f) — "Roll, Isaac, roll — Part I," *Electrical Review*, 204(7), Feb. 16, 1979, p. 38-41; (g) — "Roll, Isaac, roll — Part II," *Electrical Review*, 204(11), Mar. 16, 1979, p. 31-33; (h) — "The laws of science and of England," *Electrical Review*, 202(23), June 16, 1978, p. 27-28.
528. E. R. Laithwaite and W. R. C. Dawson, "Mass Transfer: An Introduction based on Experimental Work at the University of Sussex," Sep. 1994. A subtitle is: A system for the transfer of mass derived from the principle of conservation of momentum. On website <http://jnaudin.free.fr/html/IPemain.htm>.
529. See WO95/30832, Nov. 16, 1995.
530. Eric Laithwaite and William Dawson, "Propulsion System," U.S. Patent Number 5,860,317, Jan. 19, 1999.
531. Sweet and **Bearden**, {29a}.

532. (a) Ning Li and D. G. Torr, *Phys. Rev.*, Vol. 43D, 1991, p. 457; (b) — *Phys. Rev.*, vol. 46B, 1992, p. 5489; (c) — *Bull. Am. Phys. Soc*, Vol. 37, 1992, p. 948. Also see (d) D. G. Torr and Ning Li, *Found. Phys. Lett.*, Vol.37, 1993, p. 948.
533. E. E. Podkletnov and R. Nieminen, *Physica C*, Vol. 203, 1992, p. 441-444.
534. Igor K. Kulikov, "Inertial and gravitational masses of bosons at finite temperatures," in NASA technical package sent in response to queries of "Study of Inertial and Gravitational Masses of a Boson," *NASA Tech Briefs*, 26(2), Feb. 2002, p. 56. The report by Dr. Kulikov of the Jet Propulsion Laboratory (JPL) is carried on the website as <http://nasatech.com/TSP/PDFTSP/NPO30325.pdf>. This is a theoretical study of the relationship between the inertial mass and gravitational mass of a self-interacting neutral scalar boson in a heat bath. The difference in the two masses was determined as a function of the temperature of the heat bath. The theory for distinguishing the difference is given. Since it is presented as an inventor's report, we assume that a patent is either pending by or to JPL or already granted to it.
535. Mike LaPointe, {421}.
536. Jim Corum, T. Keech, D. Gray, P. Pesavento, and M. Duncan, "The Electro-magnetic Stress-Tensor as a possible Space Drive Propulsion Concept, presented at the AIAA Joint Propulsion Conference, July 9, 2001.
537. Hector Serrano, "Propulsion Device and Method Employing Electric Fields for Producing Thrust," WO 00/58623, Oct. 5, 2000.
538. William B. Stein, "Electrokinetic Propulsion: The Ionic Wind Argument," Energy Conversion Laboratory, Purdue University, West Lafayette, Indiana 47906, Sep. 5, 2000. This is a Gravitec report. Results can be downloaded from <http://foldedspace.com/data.html>, and an even more rigorous future test is planned.
539. A motion picture of the Naudin's replica thruster in dynamic thrust performance is shown on <http://jnaudin.free.fr/html/liftbldr.htm>, along with information on many other successful "lifters". This website is a cornucopia of information on inertial propulsion and electrogravitation, including successful independent replication and tests.

540. Ryan Mahoney, "Huntsville Firm Developing New Propulsion Technology," Birmingham Business Journal, Birmingham, Alabama July 19,2001.
541. E.g., see J. Cameron, "An Asymmetric Gravitational Wave Propulsion System," presented in the Breakthrough Propulsion Physics session of the AIAA Joint Propulsion Conference, July 9, 2001.
542. Bearden, {40}.
543. Prange and Strance, {365}
544. Privately, Sweet strongly affirmed to me that later he took the risk and pushed it a little further in output, actually levitating the system several times, including accelerating it upward, hovering it, and then letting it sink slowly down to come to rest on the bench.
545. Dirac, {249}.
546. Romer, {84}; see endnote 24, p. 109.
547. E.g., as by Giovanni Modanese, "On the theoretical interpretation of E. Podkletnov's experiment," Extract from report UTF-391/96, OANL gr-qc/9612022, presented to the *I.A.F. Congress 1997*, Number IAA-97-4.107.
548. Ling Ni and D. G. Torr, {532a-532d}.
549. Evans, {137b}; Evans, {485b}.
550. M. W. Evans, personal correspondence.
551. (a) Evans et al., {233b}; (b) — - "Development of the Sachs Theory of Electrodynamics," *Found. Phys. Lett.*, 14(6), Dec. 2001, p. 595-600; (c) Evans et al., {233a}.
552. As we point out in our discussion of cold fusion, use of this enormous time-energy density component in a time-reversal zone allows reducing the force of the gluons in a nucleon and nearly freeing the quarks. The time-reversal zone also reverses the law of attraction and repulsion of charges; now like charges attract. So the coulombic attraction of two H<sup>+</sup> ions can attract them together so closely that each enters the strong force region of the other, forming a quasi-nucleus. As the other ions in solution move to negate the time-reversal zone, the zone decays, restoring the normal repulsion of the two protons in the quasi-nucleus. However, being exponential the strong force increases much more rapidly than the normal

coulombic repulsion grows. The result is to force the two protons even closer together, into a full nucleus with a full strong force between them. This forms a nucleus of deuterium, as one quark in one of the protons is flipped while still relatively free, to form a neutron. Different but similar reactions exist to produce the excess tritium shown in many cold fusion experiments, and a similar interaction — especially between two deuteron ions — forms an alpha particle.

553. Bearden, {17}.

554. Davies, {237}, p. 105.

555. Misner, Thorne, and Wheeler, {500}, p. 5.

556. Evans and Jeffers, {459}, p. 150.

557. Evans, {137a}, p. 477.

558. Banesh Hoffman, in Foreword to Yakov P. Terletski, *Paradoxes in the Theory of Relativity*, translated from the Russian, Plenum Press, New York, 1968, p. vi, viii.

559. Kron, {162}, p. 466.

560. T. D. Lee, {239}, p. 46-47.]

561. This is well known to modern theorists, but is especially accented by Sachs and by Evans. E.g.. to even have an EM wave in space, the energy density of space has to be changing as the wave energy oscillates. This is an oscillating curvature of spacetime, a priori. So all EM waves move in a dynamically curving spacetime.

562. Sachs, {126b}.

563. These concepts are generally consistent with 0(3) electrodynamics. For rigorous exposition of 0(3) EM, see Evans, {137b} [.

564. Felix Finster, "Definition of the Dirac Sea in the Presence of External Fields," *Adv. Theor. Math. Phys.*, Vol. 2, 1998, p. 963-985.

565. J. W. Lynn and R. A. Russell, "Kron's Wave Automaton," Journal unk, date unk, p. 131. We would appreciate any researcher furnishing us a completed citation for this reference. We have a copy of the paper, but without full citation details.

566. Kron, {162}. The quote is from p. 114.



567. Kron, {32}, p. 39.

568. Kron, {306}.

569. Kron, {32}, p. 41.

570. See Stigant, {310a} for a bibliography of Kron's **publications**.

571. Several overunity researchers have been assassinated by forces and parties unknown. Many very clever means are used to do the dirty work.

As an example, there is a standard EMF "shooter" which uses Venus modification of the wavefront, to produce a wave that instantly disrupts the control of the heart's beating. There are two versions at least; one about the size of a pocketbook and for close range (30 feet) only, and one about the size of a bazooka and with longer range (up to 100 yards). About 1 minute exposure to the beam of the small weapon will result in death of the targeted individual. I have personally been hit by the small version of that device (and I have a witness who was with me at the time, and also was exposed to it). We survived by instant recognition of what it was, and by bolting immediately out the nearby back door of a restaurant here in Huntsville. If the kill is successful, the autopsy will show that the person died of a heart attack.

Stan Meyer, an overunity researcher with numerous patents, rushed from a restaurant exclaiming "They're killing me!" and expired with just such a heart attack, possibly hit inside the restaurant by a close-range shooter.

Harry Mason's associate was killed in Australia in his apartment by a longer-range, bazooka-sized shooter. The assassin was spotted putting the shooter back inside the car below, and speeding away.

Sometimes a silenced rifle is used for sniping at long range. Sweet was fired at by one such would-be assassin — luckily just as he stumbled and fell on the steps of the foyer to his apartment complex. The bullet cracked right by his ear as he fell forward, passing where his head had just been the moment before.

Another "shooter" uses longitudinal EM wave peak power pulses. This type kill is instant and very permanent. This unit can be set to stun or render the targeted person unconscious, or set to kill. It can also disrupt and stop running automobile engines (there is another version for that also, using negative energy EMP weaponry). However, it time-charges the struck human body so that the body emits longitudinal EM waves for some time after the kill. Marinov was killed with such a shooter (apparently by

KGB-related foreign intelligence operatives) and his body then thrown off a rooftop to make it appear to be suicide. Where his body lay, the pavement glowed when the body was removed. Only one weapon on earth will kill a body so that it will induce luminescence in concrete or asphalt that it lies on for a period.

Another favorite weapon is an ice dart dipped in curare. I was threatened once and told I would be killed by such an ice dart weapon if I traveled in a 2-month period. Just four days past that period, and traveling and changing planes in Dallas-Fort Worth airport, a person was killed three feet from me in broad daylight, right inside the airport, with the exact symptoms of a curare ice dart kill. That was apparently just to teach me "they" were serious.

"They" is that set of cartels that Churchill called "the High Cabal". Bedini and I had severely offended the High Cabal by Bedini's successful transmutation of copper (and other things) into gold. John often makes his own power transistors for his amplifiers, and the slag in the electric oven turns into black ruby laced with gold and silver, confirmed by assay. We have had numerous other assassination attempts, too numerous to iterate. Suffice it to say that developing a good COP>1.0 EM power system can be hazardous to one's health.

Any significant researcher should be wary of "meeting with a sudden suicide" on the way to the supermarket. Another thing to beware of, is a calibrated auto accident where your car is rammed from the rear, and you are shaken up considerably. An ambulance just happens to be passing by moments later, and it will take you to the hospital. If still conscious, the researcher must not get in the ambulance unless accompanied by a watchful friend who understands the situation and the danger. Otherwise, he can easily get a syringe of air into his veins, which will effectively turn him into a human vegetable. If he goes to the hospital safely, he must be guarded by friends day and night, for the same reason, else he runs a high risk of the "air syringe" assassination during the night.

Simply trying to do scientific work, I find it necessary to often carry (legally) a hidden weapon. Both my wife and I have gun permits, and we frequently and legally carry concealed weapons.

As early as the 1930s, T. Henry Moray — who built a successful COP>1.0 power system outputting 50 kW from a 55 lb power unit - had to ride in a bulletproof car in Salt Lake City, Utah. He was repeatedly fired at by snipers from the buildings or sidewalk, with the bullets sometimes sticking in the glass. He was also shot by a would-be assassin in his own laboratory, but overpowered his assassin and recovered.

Over the years, probably as many as 50 or more overunity researchers and inventors have been assassinated for their efforts, and particularly for their success. Some have simply disappeared abruptly and never been heard from again.

These days the use of longitudinal wave shooters (such as killed Marinov) and such is growing, since no signature is left for a normal autopsy to discover. The Yakuza, e.g., uses such "shooters" in Japan to assassinate persons or politicians having incurred their displeasure. Others are subjected to the more traditional Yakuza assassination: Three or four assassins suddenly jump the unsuspecting target, stabbing him repeatedly and with extreme rapidity. His body may have 50 to 70 deep stab wounds — through the heart, the abdomen, liver, lungs, etc. — before the body strikes the pavement.

Other very sophisticated methods of legal entrapment, gaming, planting narcotics on one's premises and tipping off the drug enforcement agencies for a drug raid in the middle of the night, etc. are utilized.

Widely used is "gaming", which uses deep psychological profiling to select a "vulnerability". The supercomputer with the game prepares a "scenario" much like writing a movie script of predictable interactions among the players to be chosen. The game involves "agents of influence" (AOIs — persons who are dogmatic, perhaps even radical, and have knee-jerk responses easily triggered, and whose vector direction when they "jump" is along or near the desired response direction), and one or two agents to do the phone conversations with the AOIs and trigger them into action), as well as a game controller or director. The computer programs also use prediction and artificial intelligence, and will forecast the probability of success of the selected game. A very extensive database of deep psychological profiles on useful AOIs and all major COP>1.0 researchers is kept in the computer. When the controller selects the game, the computer spits out the most recommended AOI players. The controller accepts or changes and then accepts, and the game scenario is then prepared. The agents trigger the AOIs, and the unwitting target is suddenly besieged from every direction, along a direction he already has an affinity or "vulnerability" towards. The controller follows the course of the game and the outcomes of all interactions between the target and the AOIs. The agent or agents add "nudges" or additional actions to overcome delays, accomplish redirection when the direction goes awry. etc. Over the decades, these games have gotten very effective indeed, and are quite difficult to content with. I having survived about 200 of these games over the last two decades, I may yet write a book on some of the major ones that

have been used against overunity researchers. The games are not confined just to the overunity field, however, and sometimes are also used to directly intervene in politics and other key situations, {754}. Machiavelli's methods are not dead; they thrive and have been highly computerized.

572. More than a dozen potential mechanisms for overunity EM interactions and systems are given in Evans et al., {233i}. Many of these interactions are likely in highly energetic astronomical phenomena such as the gamma ray burster and the X-ray burster.

573. Evans et al., {38b, 38c}.

574. Bearden, {38a}.

575. Bearden, {30}.

576. Sweet and Bearden, {29a}.

577. (a) A. G. Reiss *et al.*, *Astron. J.*, Vol. 116, 1998, p. 1009; (b) S. Perlmutter *et al.*, *Astrophys. J.*, Vol. 517, 1999, p. 565.

578. A. Einstein, *Sitzungsber. Preuss. Akad. Wiss.*, Vol. 1917, 1917, p. 142. Einstein came to regret his introduction of the cosmological constant as his "greatest blunder". Ironically, this may yet turn out to be one of his greatest contributions.

579. Prange and Strance, {365}.

580. (a) R. Lieu, "The effect of Planck scale space time fluctuations on Lorentz invariance at extreme speeds," *Astrophys. J. Lett.*, 2002 (in press). A preprint is on <http://xxx.lanl.gov/abs/astro-ph/0202443>. See also (b) Philip Ball, "Time gives rays a break," <http://www.nature.com/nsu/020304/0209304-5.html> .

581. In 1998, experimental evidence of the accelerated expansion of the universe was provided by two groups of astronomers; see (a) Riess *et al.*, {577a}; Perlmutter *et al.*, {577b}. For an attempt to provide a new model for the negative antigravity, see (c) L. Parker and A. Raval, "A new look at the accelerating universe," *Phys. Rev. Lett.*, Vol. 86, 2001, p. 749-752; (d) Philip Ball, "New model of expanding universe," *Nature News Service*, Science Update, Nov. 12, 2001. A good coverage for the educated layperson is (e) Mario Livio and Alan Sandage, *The Accelerating Universe: Infinite Expansion, the Cosmological Constant, and the Beauty of the Cosmos*,<sup>1</sup> Wiley, New York, Dec. 2000. See also (f) P. D.

Mannheim, "Implications of cosmic repulsion for gravitational **theory**." *Phys. Rev. D*, Nov. 15, 1998, p. 3511.

582. J. C. Bedini and T. E. Bearden, " Process For Transducing **Forms** of Electromagnetic Energy," U.S. Provisional Patent Application, 200 I. A formal U.S. Patent Application is in preparation as of this writing.

583. For a deep consideration of what is "meant" by mass, and how subtle the concept really is, the reader should refer to the scholarly work of Jammer {523a}. The more casual reader should be prepared for somewhat of a shock. Mass is not at all a "cut and dried" concept, as usually assumed. Indeed, the simple materialistic view of mass seems to be very much opposed by modern physics findings.

584. (a) Bearden, {12}. If we insert the absorption of a scalar (time-polarized) photon by the ubiquitously-assumed unit point charge and the subsequent re-emission of a longitudinal photon as the process for "combining" a scalar and longitudinal photon, then our solution is also consistent with (b) Mandl and Shaw, {19}. Mandl and Shaw argue that the longitudinal and scalar polarizations are not directly observable, but only in combination, where they manifest as the "instantaneous" Coulomb (i.e., electrostatic) potential. Our comment is that this argument, translated from particle terminology to wave terminology, then fits our re-interpretation of Whittaker's 1903 decomposition of the scalar potential in (c) Whittaker, {85}. It also strongly suggests the need for a complete reinterpretation of what is meant by "propagation of EM energy through 3-space".

585. E.g., see (a) V. I. Arkhipov *et al.*, "Negative transient currents in amorphous semiconductors." *Internal. J. Electronics* (UK), 51(6), 1981, p. 735-742; (b) — "An analysis of the dispersive charge transport in vitreous  $0.55 \text{As}_2\text{S}_3 : 0.45\text{Sb}_2\text{S}_3$ ," *Phys. Stat. Sol. (A)*, Vol. 54, 1979, p. 67-77; (c) — and Rudenko, A. I., "Negative currents caused by injection-controlled polarization." *Solid St. Commun.*, 28, 1978, p. 675-676.

586. Evans, {137a, 137b, 251}.

587. David Jones, *Vancouver Sun Times*, Weekend Magazine, Dec. 17, 1977, p. 17. Article on Sid Hurwich's Toronto gun-jamming demonstration, stopping of watches, and jamming of a gun.

588. For proof of production of ordinary EM fields and energy at a distance by scalar **interferometry**, see **Evans et al.**, {79}.

589. Miles and Bush, {198}, p. 101.
590. Bearden, {17}.
591. We point out, but do not further discuss, the obviously startling impact on the validity of the random statistical analyses normally used in scientific work if such "hidden variables" are present in the Earth's supersystem and interact with the experiment.
592. Kron, {192}, p. 466.
593. (a) Gabriel Kron, *Diakoptics: The Piecewise Solution to Large-Scale Systems*, MacDonald & Co., London, 1962. See also (b) Kron, {310b}.
594. Ilya Prigogine, Preface, (160b), p. xi.
595. Sir William Rowan Hamilton, 1837. Hamilton originated quaternion algebra, the Hamiltonian, etc. Hamilton's quaternion algebra has a higher group symmetry than either vectors or tensors. Since Maxwell's theory was first formulated in Hamilton's quaternion algebra and later reduced to vectors and then to tensors, ironically the first successful EM theory has been sharply curtailed rather than being further developed and extended.
596. (a) Aharonov and Bohm, {344a, 344b}.
597. Prigogine, {160b}, p. 104.
598. Lee, {441}, p. 23.
599. Jackson, {22}, p. 811-812.
600. Whittaker, {85}.
601. This is because time may be regarded as compressed spatial length, where the L compression factor is  $c$ . Since the energy of a wave is proportional to  $L^2$  (where L is the wave amplitude), then the release of ST time-density as ST energy density provides nearly  $9 \times 10^{16}$  times as much effect per second as simple energy density curvature alone does per joule. For convenience, we refer to this as the " $10^{17}$  gain factor" one obtains by releasing the compressed length energy from its time-density ST curvature form.

602. T. Matsumoto, "Mechanisms of **Electro-Nuclear Collapse**," *Proc, ICCF-7 (International Conference on Cold Fusion - 7)*, Vancouver, BC, Canada, April 1998, p. 98.

603. Romer, {84}, endnote 24, p. 109.

604. See Harter et al., {102}. For a simple analogy, we may think of the longitudinal EM wave as a sort of velocity-modulated wave; i.e., it is rhythmically changing its velocity about some average value, where that value is usually taken to be  $c$ . Another way to visualize it is as an "accordion" wave, expanding and contracting along the line of travel.

605. There are several types (polarizations) of photons utilized in physics. E.g., see (a) Ryder, {90b}. On p. 147+, Ryder discusses four polarization states of the photon. Two of these are "transverse" —i.e., the well-known x- and y-polarizations of light; one is called "longitudinal," i.e., z-directed and related to Evans' B(3) field, and one is "scalar" or timelike.

The time-like (scalar) photon we are using in this paper seems to be yet another brand, something like a cross between the Ryder's third and fourth classifications. That is, our "scalar" photon is named such because when it is imperfect it propagates (i.e., in the 7 direction) at finite speed. When perfect, it just appears instantly everywhere it will be, without propagation through space in the usual sense. Hence it can be at an infinite number of points simultaneously - very close to the notion of the pure Coulomb gauge or of Bohm's quantum potential - or it can be impure and propagate at subluminal or superluminal speeds. The main notion we intend in our present use of the "scalar" photon for this treatise is that its oscillation is in the time domain and along the time axis. We use a model which produces the flow of time itself, and a time-component structuring of that flow — something which is still absent from physics. So our time-like (scalar) photon in one part very much resembles Ryder's discussion of the "scalar" photon, but is not just that alone. For instance, both our longitudinal photon and our scalar photon seem to have internal "photon" structures that we do not discuss in this treatise.

A still deeper discussion of photon polarization is in (b) Mandl and Shaw, {19}. The longitudinal and scalar polarizations are not directly observable, but only in combination, where they manifest as the "instantaneous" Coulomb (electrostatic) potential. So by this route one arrives at a well-established mathematical theory that allows a hidden substructure within **the photon itself**. Mandl and Shaw include the

photon's four polarization states as related to the four independent degrees of freedom available in the vector potential  $A$ . Suppression of the longitudinal and scalar polarizations is accomplished by "fixing the gauge". This reduces the independent degrees of freedom from 4 to 2, giving the conventional electrodynamics. However, when one raises serious foundations flaws in that resulting conventional electrodynamics, it is obvious that the entire structure is still on somewhat shaky ground. An even better mode might be to consider the fundamental photon entity as existing in all degrees of freedom, and the various "kinds" of photons existing due to restrictions or partial restrictions placed on one or more of these degrees of freedom. This of course opens the stage to interactions that change one (restricted) type of photon into a different (restricted) type. That is essentially the basis for my use of the notion of "photon transduction". It also leads to the transposition of time into energy and vice versa, which I use in my own approach, but which is still missing from nuclear physics. Since experimentally the cold fusion phenomena seem to require that characteristic, we have retained it.

We are indebted for much of the preceding discussion to private correspondence from Bob Flower, a fine scientist and knowledgeable in this area. Flower has pointed out that the conventional photon theory outlined by the cited authors is missing the possibility that nonlinear phase-conjugate optics could make the photon's longitudinal and scalar polarizations manifest in an experiment. Or put another way, if the instantaneous Coulomb potential could be decomposed into a time-like component and a longitudinal component, it would allow the two hidden polarization states to be controlled directly. This would result in anomalous modifications of the EM vector potential, leading to measurable electromagnetic or quantum effects. Flower's observation seems to be the closest to our own view, stated more simply in the present paper.

606. The result of our yet-unfinished struggle in these *very* swampy photon waters is not entirely consistent with the conventional view. Nonetheless, the new approach does seem to fit and explain most of the anomalous cold fusion phenomena, as well as a wide variety of other phenomena previously deemed beyond the pale of physics itself. E.g., by noting that *mind is time-like in its operations*, and therefore directly uses time-polarized (scalar) photons, waves, and electrodynamics, then mind operations become totally electromagnetic, but of a dramatically extended electrodynamic nature presently being approached in quantum field theory. That approach leads directly to a testable and engineerable theory of mind



on all its levels (conscious, subconscious, unconscious, species unconscious, biospheric or all-species unconscious, and so on). But since the mind can interact with the body and produce at least the initial spatial forces carrying out intent in the physical world, it follows that some process must exist whereby the "time-like" photon interacts with and changes one or more of the other photons in the conventional view. Our use of *transduction* in fact encompasses that, based on quantum field theory as described by Ryder {90b} and by Mandl and Shaw {19}. Further, the present author's transduction reinterpretation of Whittaker's 1903 and 1904 papers {85, 91a} means that Whittaker's work as reinterpreted strongly supports this approach mathematically. So the approach used directly incorporates *mind and matter interaction*, again on multiple levels. While this area of *engineerable* mind and matter interaction is well beyond the scope of this treatise, it has become possible to begin the physics of the living being — even of the entire living universe — and to foresee direct engineering of the various realms of mind itself. Indeed, Russian psychoenergetics - particularly the highly weaponized secret part of it - already is involved in just that capability in deployed operational equipment of great portent. Since real results and real explanations of diverse metabiological phenomena have arisen from the approach as well as a very deep "more ordinary" physics including the necessary corrections to electrodynamics, we have continued to follow it to see where it eventually leads. A future book is planned on the more positive and beneficial uses of such startling technology. A preliminary view can be had on the author's website, [www.cheniere.org](http://www.cheniere.org), in the "porthole concept" briefing. A patent application has in fact been filed on this startling new method of medical healing.

607. (a) Vlail Kaznacheyev and L. P. Mikhailova, *Ultraweak Radiation in Intercellular Interactions*, [in Russian], Novosibirsk, 1981 [an English exposition of much of the Kaznacheyev work is given in (b) Vlail Kaznacheyev, "Electromagnetic Bioinformation in Intercellular Interactions," *Psi Research*, 1(1), Mar. 1982, p. 47-76.] See also (c) Kaznacheyev *et al.*, "Distant intercellular interactions in a system of two tissue cultures," *Psychoenergetic Systems*, 1(3), Mar. 1976, p. 141-142. In the same issue, see (d) "A Comment" by William A. McGarey, p. 143; (e) "A Comment" by Arthur C. Hastings, p. 143-144. See also (i) Yu. A. Vladimirov, "Ultraweak luminescence of subcellular structures," *Ultraweak Luminescence in Biology: Proceedings of the Symposium*, Moscow, 1969 [In Russian], Robert Becker also showed in his healing of

otherwise intractable bone fractures that a simple scalar potential (now known to involve the direct transduction between scalar and longitudinal photons and vice versa), that cellular dedifferentiation and redifferentiation of red blood cells occurred in the scalar potential region across the damaged bone cells, and directly in such manner as to "eliminate the delta engine" in those damaged bone cells in the fracture. The red cells shucked their hemoglobin, turning back (time-reversing) to a more primitive cell (earlier state). Then they redifferentiated (time-forwarded) into the type cells that make cartilage. There is still a delta engine between cartilage and bone! So these cartilage-like cells redifferentiated again into the kind of cells that make bone. These latter cells were deposited in the fracture, healing it. This process is in fact used today in various medical hospitals, without any real understanding of the physics mechanism involved. In short, it has long been experimentally proven without understanding the actual mechanism by which it works. See (g) Robert O. Becker, "The direct current field: A primitive control and communication system related to growth processes," *Proc. XVII International Congr. Zoology*, Washington, D.C., Vol. 3, 1963, p. 179-183; (h) — and Charles H. Bachman and Howard Friedman, "The direct current system: A link between the environment and the organism," *New York State J. Medicine*, Vol. 62, April 15, 1962, p. 1169-1176; (i) — and Joseph A. Spadaro, "Electrical stimulation of partial limb regeneration in mammals," *Bull. N.Y. Acad. Med.*, Second Series, 48(4), May 1972, p. 627-64. See also (j) C. A. L. Bassett; R. O. Becker, and R. J. Pawluk, "Effects of electric currents on bone *in vivo*," *Nature*, Vol. 204, Nov. 14, 1964, p. 652-654.

608. Puthoff, {202}.

609. See (a) A. Shapere and F. Wilczek, Eds., *Geometric Phases in Physics*, World Scientific, 1989. See also (a) M V. Berry and J. M. Robbins, "Indistinguishability for quantum particles: spin, statistics and the geometric phase," *Proc. Roy. Soc. LondA*, Vol. 453, 1997, p. 1771-1790.

610. See Mandl and Shaw, {19}, Chapter 5 and simply reinterpret the coupled scalar and longitudinal photon pair as a spin 2 graviton.

611. In fact, Sweet's vacuum triode amplifier probably used the domains and nuclei in a barium ferrite permanent magnet in such a graviton reaction manner. In an epochal experiment designed and conceived by the present author, Sweet reduced the weight of the device

on the lab bench, smoothly and efficiently, by 90 degrees. For **the** description, see Sweet and Bearden, {29a}.

612. Reginald I. Gray, *Unified Physics*, Naval Surface Warfare Center, Dahlgren, VA, 1988, p. 2-19.

613. For the basic explanation of a scalar interferometer, see Evans et al., {79}.

614. See Chapter 3, paragraph 3.1 through 3.5.

615. Bearden, {12}.

616. As an example, see Bunge, {3}, p. 179-180. Quoting: "*The most complete direct interparticle action theory of electromagnetism is WHEELER and FEYNMAN'S (1949). Its central postulate is Fokker's action principle for a collection of point charges.... from which the equations of motion for charged particles follow. As can be seen, only particle variables occur in this theory, which is an electrodynamics in AMPERE'S sense and therefore the opposite of a unitary field theory. (The theory is mathematically equivalent to an "adjunct" field theory, but this adjunct field, far from being free, is attached to the particles.) The theory has been abandoned by its creators because it is inconsistent with the quantum theory, in particular with the photon hypothesis. Yet it continues to appeal to many not only because it smacks of mechanism and operationalism, but also because no self-forces appear in it and consequently no infinite self-forces (and the corresponding self-accelerations) But this is too small an advantage compared with its shortcomings even at the classical level. Indeed, the theory makes use of special relativity - as is apparent from its central axiom...yet it is inconsistent with it for SR borrows from CEM the assumption that e.m. signals propagate in a vacuum with a constant speed  $c$  and moreover lead an existence, which, while it lasts, is independent of both emitters and absorbers. In other words, by denying the existence of free radiation fields propagating in space, the action at a distance formulation of CEM contradicts its own basis: it is logically inconsistent.*"

Our comment is that the "photon" interaction itself must be re-examined in light of the demonstrated giant negentropy of every change and dipole in the universe. Allowing for the quantum field theoretic combination of the scalar and longitudinal photons as an observable "photon" that is actually a spin-2 graviton in 4-space rather than 3-space. the entire nature of "propagation of EM energy through space" changes. No photon has ever interacted in just 3-space; instead, it interacts in

4-space. In the strong interpretation of giant negentropy, there is really no such thing as a "single observable photon" in the universe. Instead, there is a combined scalar/longitudinal photon pair, which when interacting in matter causes transverse EM wave movement of the interacting/detecting charges which are restrained by (i) the inertia due to their own mass, and (ii) in circuits, the back repulsion of all other like charges longitudinally ahead of the excited charge that absorbs the "photon" (actually, the graviton). Considering the longitudinal wave "bunching and relaxing" actions resulting in galloping, then the conventional assumption of the constant speed of light  $c$  in vacuum is destroyed. What we perceive as "light propagating in space at speed  $c$ " already moves in a galloping and jerky motion *about* speed  $c$  — now moving superluminally, now moving subluminally — with only an *average* speed of  $c$  overall. In turn, anything which affects the performance and "galloping mechanism" exhibited by the longitudinal EM wave can in theory be used to change the speed  $c$ . With the coming advent of the Fogal semiconductor and direct superluminal communication, all such objections based on previous rather classical assumptions will simply fall by the wayside. We also stress that the speed of gravitational field is shown in astronomical events and effects to be extraordinarily superluminal by many orders of magnitude. Again, this greatly upsets many of the modeling assumptions in present physics. Physics is based on a set of models and a set of experiments and observed effects. If the experimental effects negate the theory, one has to change the theory or be guilty of abandoning scientific method altogether, thereby turning science into dogma.

617. Cohen, {89}.

618. See Rod Donnelly and Richard Ziolkowski, "Electromagnetic field generated by a moving point charge: A fields-only approach," *Am. J. Phys.*, 62(10), Oct. 1994, p. 916-922. In conventional language, both the transverse and longitudinal field components always try to be born initially, whenever an EM wave is being generated. Generation of the transverse component produces a function which zeroes the longitudinal component. The function appears in the spacetime representation of the transverse EM fields, obtained by Donnelly and Ziolkowski using special transforms. The phase conjugating and retroreflecting aspects of cold fusion experiments produce spacetime curvatures, directly affecting the "canceling function." The altered function becomes an "LW-reduction function" which is postulated to determine the mix of transverse and longitudinal field components that emerge in the interactions.

619. Whittaker, {85} shows that the scalar potential is **comprised of** bidirectional longitudinal EM wavepairs. Whittaker, {91a} shows **that all** fields and waves are comprised of two interfering scalar **potential** functions. Hence all fields and waves are comprised of **functions** of longitudinal and scalar wave interferometry.

620. Evans et al., {79}.

621. Usually the detecting GM tubes will detect the interferometry of the incident longitudinal EM waves with the weak LWs being emitted in the tube itself by time-decay of its time-charges. The resulting transverse wave EM energy ionizes the tube's gas, and the GM tube "reads." If little or no time-decay is occurring, then there will be little or no transduction into TWs, hence little or no ionization. In that case the instrument will not read.

622. Miles and Bush, {198}, p. 101.

623. *Ibid.*

624. (a) Evans, {137b}; (b) Evans et al., {233a, 233f}.

625. Rodrigues and Lu, {93a}.

626. Enders and Nimtz, {329b}.

627. (a) W. A. Rodrigues, Jr. and J. Vaz Jr., "Subluminal and Superluminal Electromagnetic Waves and the Lepton Mass Spectrum," *Kluwer Ac. Pub. Proceedings*, <hep-th/9607231> on Los Alamos web site; (b) P. Letelier and W. A. Rodrigues Jr. (Eds.), *Gravitation: The Spacetime Structure*, World Scientific Publishing Co., Singapore, 1994; (c) J. Vaz Jr. and W. A. Rodrigues Jr., "On the equivalence of Maxwell and Dirac Equations, and Quantum Mechanics," *Internal. J. Theor. Phys.*, Vol. 32, 1993, p. 945-958; (d) J. Vaz Jr. and W. A. Rodrigues Jr., "Maxwell and Dirac Theories as an Already Unified Theory," *Adv. Appl. Clifford Algebras*, Vol. 7 (S), 1997, p. 369-386; (e) W. A. Rodrigues Jr. and J. E. Maiorino, "A unified theory for construction of arbitrary speeds ( $0 < v < \infty$ ) solutions of the relativistic wave equations." *Random Operators and Stochastic Equations*, Vol. 4, 1996, p. 355-400; (f) Rodrigues and Vaz, {93b}.

628. Torn Van Flandern, "The speed of gravity - What the experiments say," *Phys. Lett. A*, Vol. 250, 21 Dec. 1998, p. 1-11.

629. *Ibid.*, p. 9.

630. *Ibid.*, p. 10.

631. A. A. Vlasov and V. I. Denisov, "Einstein's formula for gravitational radiation is not a consequence of the general theory of relativity," *Theor. Math. Phys.*, 53(3), June 1983 (English translation), p. 1208-1216. Translated from *Teoreticheskaya i Matematicheskaya Fizika*, 53(3), Dec. 1982, p. 406-418 [in Russian].

632. D. Hilbert, *Göttingen Nachrichten*, Vol. 4, 1917, p. 21.

633. Sen, {68}, p. viii.

634. Mandl and Shaw, {19}.

635. Logunov, A. A. and Yu. M. Loskutov, "Nonuniqueness of the predictions of the general theory of relativity," *Sov. J. Part. Nucl.*, 18(3), May-June 1987, p. 179-187.

636. Whittaker, {85}

637. I.e., that spacetime == scalar potential == virtual particle flux == Whittaker biwave set. If that holds, then when we engineer the internal structure of the scalar potential, we also simultaneously engineer the internal structuring of the vacuum and spacetime itself, with deliberately formed spacetime curvature engines (vacuum engines). This is vacuum engineering — by different means — of the sort proposed by Nobelist T. D. Lee, {73}, p. 380-381. On p. 383, Lee points out that the microstructure of the scalar vacuum field (i.e., of vacuum charge, or — in our view — of the vacuum potential) has not been utilized. Particularly see Lee's own attempt to indicate the possibility of using vacuum engineering, in his "Chapter 25: Outlook: Possibility of Vacuum Engineering," p. 824-828.

638. Ingram Block and Horace Crater, "Lorentz-Invariant Potentials and the Nonrelativistic Limit," *Am. J. Phys.*, 49(1), Jan. 1981, p. 67.

639. Roderic Lakes, "Experimental Limits on the Photon Mass and Cosmic Magnetic Vector Potential," *Phys. Rev. Lett.*, 80(9), Mar. 2, 1998, p. 1826. Our critique is that the given equations define nothing at all, since no equation is a definition. If one replaces the "=" with "==" in the "definition" of the A-potential in terms of B, one then has B==curl A, which is actually the definition of B in terms of A. If A has no energy, then neither can B, which is just the swirl of the A-energy. If A has no curl, B vanishes. If A has no energy, B vanishes. Yet  $dA/dt = -E$ , whether

A has curl or not, and E has energy. Ergo, A must have energy if **any** operation upon it is to produce **E-field** energy, else one has **violated** the conservation of energy law and advocates creation of energy from **nothing**. Regardless of how one looks at  $B = \text{curl } A$  and  $B = \text{curl } A$ , neither the equation nor the identity defines A in terms of B, because B is always, just one aspect of A and yet A can exist without any curl at all — without B as demonstrated in the Aharonov-Bohm effect. But in no fashion can B exist without A. Therefore A is primary and B is derived, and if A has no energy then B can have no energy. V has energy and energy density, since in fundamental units any point of the potential V is identically the joules of energy collected upon a unit point positive electrical charge assumed at that point. If it had no energy, then no joules could be collected from it.

640. Weinberg, {194}, p. 109-110.

641. Sen, {68}, p. viii.

642. (a) Lee, {13a}; (b) Wu et al., {14}; (c) Lee, {239}, p. 57-59; (d) Lee, {73}, p. 184.

643. Bearden, {12}

644. Whittaker, {85}.

645. The clustering of virtual charges around observable individual charges — due to the polarization of the vacuum — is well known in quantum electrodynamics. Macroscopically one sees the charge as partially shielded by the cluster, so the clustering charges are known to have macroscopic significance. At close enough distances, one sees the "bare" charge with reduced shielding.

646. Mandl and Shaw, {19}.

647. (a) Aharonov and Bohm, {344}; (b) R. G. Chambers, {474}.

648. E.g., see (a) Barrett, {345}; Barrett and Grimes [Eds.], {235b}.

649. (a) Evans *et al*, {113a}; (b) — "Self-Inconsistencies of the U(1) Theory of Electrodynamics: Michelson Interferometry," *Found. Phys. Lett.*, 12(6), Dec. 1999, p. 579-584; (c) — *J. New Energy*, Vol. 4, Winter 1999, p. 231-235; (d) — "Derivation of the Lehnert Field Equations from Gauge Theory in Vacuum: Space Charge and Current," *Found Phys Lett.*, 13(2), April 2000, p. 179-184; (e) Evans et al., {233g}; (f) Evans et al., {233e}; (g) — "**Equations of the Yang-Mills Theory of Classical Electrodynamics**," *Optik*, 111(2), 2000, p. 53-56; (h) **Evans et al.**, {113b}.

Also (i) more than 100 papers on restricted U.S. Department of Energy Internet website <http://www.ott.doe.gov/electromagnetic/>.

650. Obviously we exclude active systems such as matter that decays in nuclear fashion. Those are not inert systems, but are "pre-excited" systems whose matter has had excess energy since its formation during the birth of the universe.

651. (a) Kondepudi and Prigogine, {160c}; (b) — "Thermodynamics, Nonequilibrium," *Ency. Appl. Phys.* Vol. 21, 1997. p. 311-337.

652. I.e., the known broken symmetry of the charge (regarded as a set of composite dipoles) in its vacuum energy exchange.

653. Kraus, {76}, p. 578, Figure 12-60, a and b.

654. James Croll, *Phil. Mag.*, Series 5, Vol. 2, 1876, p. 242-254.

655. Heaviside, {5a-5c}.

656. Poynting, {4a, 4b}.

657. Heaviside, {106}.

658. E.g., see Lorentz, {109}.

659. E.g., (a) Panofsky and Phillips, {110}; (b) Gough and Richards, {224b}. (c) Jackson {22}, p. 259, points out the arbitrary nature of the Poynting vector and disposes of any added nondivergent energy flow vector with the words "*Such an added term can, however, have no physical consequences.*"

660. Simply examine  $Vqt$  around the forward emf section (the external circuit between the generator terminals and the ends of the source dipole inside the generator), and  $-Vqt$  across the generator terminals (and the source dipole).

661. Evans et al, {38b, 38c}.

662. Bohren, {24}. Independent replication is reported in the same journal issue; see (b) Paul and Fischer, {25}.

663. Bearden, {40}.

664. See Paragraph 8.3.16 in Chapter 8 for the explanation.

665. Olariu and Popescu, {482}.



666. Bertram Schwarzschild, "Currents in normal-metal rings **exhibit** Aharonov-Bohm effect," *Phys. Today*, 39( 1). Jan 1986, p. 17-20.
667. Paul and Fischer, {25}.
668. One actually inputs far more electrical energy flow from **the** external electrical power supply than is conventionally accounted, if one accounts for the huge nondiverged Heaviside energy flow component that Lorentz arbitrarily discarded. That energy flow is actually present, but is not accounted once Lorentz' integration trick is applied to integrate the entire energy flow vector around a closed surface assumed around any volume element of interest.
669. Evans et al., {113a}.
670. As is any EM system when the nondiverged very large Heaviside energy flow component is accounted in addition to the diverged Poynting energy flow component.
671. Bearden and Bedini, {582}.
672. As an example, two scalar potentials  $\phi_1$  and  $\phi_2$  may have precisely the same intensity magnitude, but different Whittaker internal bidirectional longitudinal EM wave structures. The effects of the two externally identical potentials — as in various chemical reactions — can be quite different. See Bearden, {17}.
673. Lee, {73}, p. 380-381.
674. Lee, {73}, p. 184.
675. For succinct summary of the major symmetries and broken symmetries in physics, see Lee, {239}, p. 57-59.
676. Wang and Chung, {33}.
677. Jean-Louis Naudin, "Chung's Negative Resistance Experiment", on website <http://jnaudin.free.fr/enr/enrexpl.htm>.
678. Burford and Verner, {35a}.
679. Early but sophisticated analogue simulator. E.g., see Kron, {306}, p. 173.
680. E.g., see (a) Kron, {32}, p. 39. Quoting: "*Although negative resistances are available **for** use with a network analyzer...*"; — "Numerical solution of ordinary and partial differential equations by

means of equivalent circuits." See also (b) Kron, *J. Appl. Phys.*, Vol. 16, Mar. 1945a, p. 173. Quoting "...since none or only a few negative resistances exist on practical network analyzers" (accent added). In the second quotation, arguably Kron was required to insert the underlined words. In the first quotation, the censors missed the clarity of the statement.

681. Kron, {192}.

682. Sweet and Bearden, {29a}.

683. Self-oscillation in such magnetic materials (which are also optically active) is well known. E.g., (a) L'vov, {29c}; (b) Borovik-Romanov and Sinha [Eds.], {369b}. See particularly (c) Gurevich and Melkov, {232c}.

684. Rosenthal publicly verified the results of his tests of the Sweet device to the 26th session of the Intersociety Energy Conversion Engineering Conference (IECEC '91), Boston, Massachusetts, 1991.

685. David M. Pepper, "Applications of Optical Phase Conjugation," 254(1), Jan. 1986, p. 83.

686. Bearden, {15}, p. 2-10.

687. Bearden, {17}.

688. Time-polarized photons are recognized in quantum field theory, implying the existence of time-polarized EM longitudinal waves. In coupling with spatial longitudinally polarized EM waves in wavepairs, the coupling is observable as scalar potential energy (stress energy), based on an argument by Mandl and Shaw {19}. Opposing time-polarized longitudinal EM waves therefore constitute "time-stress", "time-stress potential", and optical pumping in the time domain, which is hypothesized to reverse the normal "forward time" law of attraction and repulsion of charged particles.

689. Kenneth Shoulders and Steve Shoulders, {38If}.

690. U.S. patent numbers 5,018,180; 5,123,039; 5,054,046; 5,054,047.

691. Jain, {35b}.

692. Cao et al, {264b}.

693. Prange and Strance, {365}.

694. Roger Penrose, {82}, p. v.
695. Bunge, {3}, p. 176.
696. Albert Einstein, {1a}, p. xi-xii. Appendix I.
697. Raymond A. Serway, *Physics for Scientists and Engineers with Modern Physics*, Third Edition, updated version, Saunders College Publishing, Philadelphia, 1990, p. 620.
698. Max Planck, *Treatise on Thermodynamics*, 3rd ed., Dover, New York, 1945.
699. Paul Davies, *Superforce: The Search for a Grand Unified Theory of Nature*, Simon and Schuster. New York, 1984, p. 105.
700. D. Hilbert, *Göttingen Nachrichten*, Vol. 4, 1917, p. 21.
701. A. A. Logunov and Yu. M. Loskutov, "Nonuniqueness of the predictions of the general theory of relativity," *Sov. J. Part. Nucl.*, 18(3), May-June 1987, p. 179.
702. David Whitehouse, "Beads of doubt," BBC News, July 18, 2002, <http://news.bbc.co.Uk/1/hi/sci/tech/2135779.stm>.
703. Matthew Chalmers, "Second law of thermodynamics 'broken'," *New Scientist*, July 19, 2002, carried on New Scientist website at <http://www.newscientist.com/news/print.jsp?id=ns99992572>.
704. G. M. Wang, E. M. Sevick, Emil Mittag, Debra J. Searles, and Denis J. Evans, "Experimental Demonstration of Violations of the Second Law of Thermodynamics for Small Systems and Short Time Scales," *Phys. Rev. Lett.*, 89(5), July 29, 2002, 050601.
705. Elias P. Gyftopoulos and Gian Paolo Beretta, *Thermodynamics: Foundations and Applications*, MacMillan, 1991. This is an elaborate text developed over the years at MIT.
706. Dilip Kondepudi and Ilya Prigogine, *Modern Thermodynamics: From Heat Engines to Dissipative Structures*, Wiley, NY, 1999.
707. Valery Chalidze, *Entropy Demystified: Potential Order, Life and Money*, Upublish.com, 2000. Contains an excellent nonmathematical exposition of the second law.

708. J. S. Dugdale, *Entropy and Its Physical Meaning*, Taylor & Francis, 1996. This book is of a more mathematical bent, but a very thorough treatment.
709. Craig F. Bohren, *Am. J. Phys.*, 51(4), Apr. 1983, p. 323-327.
710. V. S. Letokhov, {157}, *ibid.*
711. (a) D. K. Sen, *Fields and/or Particles*, Academic Press, London and New York, 1968, p. viii. Thirty-two years later, we published the solution to that problem in (b) T. E. Bearden, "Giant Negentropy from the Common Dipole," *J. New Energy*, 5(1), Summer 2000, p. 11-23. Also carried on DoE restricted website <http://www.ott.doe.gov/electromagnetic/> and on [www.cheniere.org](http://www.cheniere.org).
712. T. E. Bearden, "EM Corrections Enabling a Practical Unified Field Theory with Emphasis on Time-Charging Interactions of Longitudinal EM Waves," *J. New Energy*, 3(2/3), 1998, p. 12-28.
713. Dilip Kondepudi and Ilya Prigogine, *Modern Thermodynamics*, *ibid.*, p. 459.
714. E.g., see D. Jou, *Extended Irreversible Thermodynamics*, Springer-Verlag, New York, 1996.
715. Sources for this table are: (a) Roy Porter, Consultant Editor, *The Biographical Dictionary of Scientists*, Second Edition, Oxford University Press, NY, 1994; (b) Kondepudi and Prigogine, {703}, *ibid.*; (c) Serway {697}, *ibid.*; (d) K. Martinas, L. Ropolyi, and P. Szegegi (eds.), *Thermodynamics: History and Philosophy*, World Scientific, London, 1991; (e) Stephen F. Mason, *A History of the Sciences*, New Revised Edition, Collier Books, NY, 1962; (f) E. T. Bell, *Men of Mathematics*, Simon & Schuster, NY, 1986; (g) Charles Singer, *A Short History of Scientific Ideas to 1900*, Oxford University Press, London, 1959; (h) William C. Reynolds, *Thermodynamics*, Second Edition, McGraw-Hill, NY, 1968; (i) Paul Edwards (Ed. in Chief), *The Encyclopedia of Philosophy*, Vols. 1-8, Macmillan, NY, 1967; (j) I. Asimov, *Asimov's Biographical Encyclopedia of Science and Technology*, Second Revised Edition, Doubleday, Garden City, NY, 1982; (k) Jeff Biggus, *Sketching the History of Statistical Mechanics and Thermodynamics*, 2002, <http://history.hyperjeff.net/statmech.html>, (l) J. B. Jones and G. A. Hawkins, *Engineering Thermodynamics*, Wiley, New York, 1986; (m) Kenneth Wark, *Thermodynamics*, Third Edition, McGraw-Hill, 1977.

716. Antoine Laurent Lavoisier, *Elementary Treatise on Chemistry*, 1798.
717. I. Asimov, *Asimov's Biographical Encyclopedia of Science and Technology*, Second Revised Edition, Doubleday. Garden City, NY, 1982.
718. Benjamin Thompson (Count Rumford), *Enquiry Concerning the Source of Heat which is Excited by Friction*, 1798.
719. Eugene F. Mallove, "The Mysteries and Myths of Heat: A Brief History of Hot and Cold," *Infinite Energy*, May-June 2001, issue #37.
720. Julius Robert Mayer, 1814-1878. In 1842, Mayer's classic paper on conservation of energy was published in *Annalen der Chemie*. He then published several papers himself. With no recognition and bitterly attacked, Mayer suffered a nervous breakdown and attempted suicide, being committed to institutions for several years. From 1858 he began to receive well-justified recognition. He was lauded by the scientific community and received the Royal Society's Copley Medal in 1871.
721. Rudolf Clausius, "On the Moving force of Heat and the Laws of Heat Which May be Deduced Therefrom," 1850.
722. Mallove, {719}.
723. James Clerk Maxwell, "A Dynamical Theory of the Electromagnetic Field," *Roy. Soc. Trans.*, Vol. CLV, 1865, p 459. Also in *The Scientific Papers of James Clerk Maxwell*, 2 vols. bound as one, edited by W. D. Niven, Dover, New York, 1952, Vol. 1, p. 526-597.
724. Actually, it is not *proven* that the energy of the universe is constant. With the recent experimental findings that the expansion of the universe is accelerating, the kinetic energy of the universe could be increasing. Whether this is offset by an appropriate change in the physical universe's supersystem remains to be seen.
725. Jeff Biggus, "Sketching the History of Statistical Mechanics and Thermodynamics," <http://history.hyperjeff.net/statmech.html>.
726. For a discussion of the modern death of matter and the death of materialism, see Paul Davies and John Gribbin, *The Matter Myth*, Simon & Schuster, NY, 1992. Quantum mechanics shook the foundations of materialism and the clockwork world, and chaos has **finished the** devastation. For a scholarly dissertation on mass, see Max **Jammer**,

*Concepts of Mass, in Classical and Modern Physics*, Harvard University Press, Cambridge, MA, 1961.

727. Dilip Kondepudi and Ilya Prigogine, *Modern Thermodynamics: From heat Engines to Dissipative Structures*, Wiley, New York, 1998, p. 3.

728. Serway, {697}, p. 507.

729. Serway, *ibid.*, p. 507.

730. Serway, *ibid.*, p. 508.

731. Serway, *ibid.*, p. 527.

732. Lindsay and Margenau, *Foundations of Physics*, Dover, New York, 1963, p. 214.

733. Robert H. Romer, "Heat is not a noun," *Am. J. Phys.*, 69(2), Feb. 2001, p. 107-109. This is an editorial discussion by the Editor of *Am. J. Phys.* of the concept of heat in thermodynamics, where heat is not a substance, not a thermodynamic function of state, and should not even be used as a noun.

734. Serway, *ibid.*, p. 527-528.

735. Serway, *ibid.*, p. 588.

736. T. E. Bearden, *Energetics: Extensions to Physics and Advanced Technology for Medical and Military Applications*, CTEC Proprietary, Mar. 21, 1998, 200+ page inclosure to CTEC Letter to Gen. (Ret.) Walter Busby, Deputy Secretary of Defense for Counterproliferation and Chemical and Biological Defense, March 21, 1998. This communication proposed a crash program to develop a portable suitcase-size treatment device based on this effect, for use in treating mass casualties after forthcoming terrorist attacks by weapons of mass destruction. Treatment of a patient would have required only five minutes. Copies were also sent to the U.S. Air Force, National Institutes of Health, and other key government agencies. Three and a half years later, the attack on the World Trade Center and the Pentagon — and a foiled attack on the White House — occurred on September 11, 2001. Today the nation is at war against international terrorism, and extensive changes in defense of the heartland are also under way. However, there still appears to be no real solution to the problem posed by mass casualties, particularly which professional

strikes can produce casualties in the hundreds of thousands or a few millions.

737. (a) A. J. Berteaud and A. M. Bottreau, "Analyse des **rayonnements** electromagnetiques emis par l'appareil Priore," [Analysis of **the** electromagnetic radiations emitted by the Priore apparatus], D.R.M.E., 1971, p. 3-12; (b) A. J. Berteaud, A. M. Bottreau, A. Priore, A. N. Pautrizel, F. Berlureau, and R. Pautrizel, "Essai de correlation **entre** l'evolution d'une affection par Trypanosoma equiperdum et l'action d'une onde electromagnetique pulsee et modulee," [Trial of the correlation between the evolution of a disease by Trypanosoma equiperdum and the action of a pulsating and modulated electromagnetic wave], *Compt. Rend. Acad. Sri.* (Paris), Vol. 272, 1971. p. 1003-1006; (c) R. Cambar, "Rapport general des travaux de la Commission de Controle constituee en vue de verifier l'un des effets biologiques obtenu par l'utilisation de l'appareillage de Priore A. Bordeaux," [General findings of the work of the control commission formed to verify one of the biological effects obtained by use of the apparatus of A. Priore at Bordeaux], 1969, I vol., (d) R. Courier, "Expose par M. le Professeur R. Courier, Secretaire Perpetuel de L'Academie des Sciences fait au cours d'une reur on a L'Institut sur les effets de la Machine de M. A. Priore le 26 Avril 1977," [Presentation by Professeur R. Courier, Perpetual Secretary of the Academy of Sciences, made at the meeting of the Academy on the effects of the machine of M. A. Priore.] (e) G. Delmon and J. Biraben, "La croissance du carcinome de Guerin sour Faction de champs electromagnetiques." [The growth of carcinoma treated by the action of electromagnetic fields], *Rev. Path. Comp.*, 3(2), 1966, p. 85-88. (f) G. Mayer, A. Priore, G. Mayer and R. Pautrizel, "Action de champs magnetiques associes a des ondes electromagnetiques sur l'orchite trypanosominne due lapin," [Action of magnetic fields associated with electromagnetic waves on the typanosomian orchitis of the rabbit], *Compt. Rend. Acad. Sci.* (Paris), Vol. 274, 1972, p. 3011-3014. Many more reports of the novel cures are in the French medical literature, particularly by Pautrizel (g) Priore's doctoral thesis (which was rejected when the project was suppressed) is: *Guerison de la Trypanosomiase Experimental Aigue et Chronique par L'action Combinee de Champs Magnetiques et D 'Ondes Electromagnetiques Modules.* [Healing of intense and chronic experimental trypanosomiasis by the combined action of magnetic fields and modulated **electromagnetic** waves], thesis submitted in candidacy for the doctoral degree, 1973. (h) Antoine Priore, "Apparatus for producing radiations penetrating living

cells," U.S. Patent No. 3,368,155, Feb. 6, 1968;(i) — "Method of producing radiations for penetrating living cells," U.S. Patent No. 3,280,816, Oct. 25, 1966; (j) — "Procede et dispositif de production de rayonnements utilisables notamment pour le traitement de cellules vivantes," [Procedure and Assemblage for Production of Radiation Especially Serviceable for the Treatment of Living Cells], Republique Francais Brevet d'Invention P.V. No. 899.414, No. 1,342,772, Oct. 7, 1963; (k) Eric Perisse, *Effets des Ondes Electromagnetiqv.es et des Champs Magnetiques sur le Cancer et la Trypanosomiase Experimentale* [Effects of Electromagnetic Waves and Magnetic Fields on Cancer and Experimental Trypanosomiasis], Doctoral thesis, University of Bordeaux No. 83, March 16, 1984.

738. (a) R. O. Becker, "The neural semiconduction control system and its interaction with applied electrical current and magnetic fields," *Proc. XI Internatl. Cong. Radiology*, Vol. 105, 1966, p. 1753-1759, Excerpta Medica Foundation; Amsterdam; (b) — "The direct current field: A primitive control and communication system related to growth processes," *Proc. XVII Internatl. Congr. Zoology*, Washington, D.C., Vol. 3, 1963, p. 179-183; (c) — "Electromagnetic fields and life," *Psychoenergetic Systems*, Vol. 3, No. 1-4, 1979, p. 119-128; (d) - - "A technique for producing regenerative healing in humans," *Frontier Perspectives*, 1(2), Fall/Winter 1990, p. 1-2; (e) - - "The Biological Effects of Magnetic Fields — A Survey," *Med. Electron. Biol. Engr.*, Vol. 1, 1963, p. 293-303; (f) — - "The bioelectric field pattern in the salamander and its stimulation by an electronic analog," *IRE Trans. Med. Electronics*, Vol. ME-7, July 1960, p. 202-207; (g) - - and Charles H. Bachman, and Howard Friedman, "The direct current system: A link between the environment and the organism," *New York State J. Med.*, Vol. 62, April 15, 1962, p. **1169-1176**; (h) — — and Joseph A. Spadaro, "Electrical stimulation of partial limb regeneration in mammals," *Bull. N.Y. Acad. Med.*, Second Series, 48(4), May 1972, p. 627-64; (i) - - and Carlton F. Hazlewood, Abraham R. Liboff, and Jan Walleczek, *Electromagnetic Applications In Medicine*, NIH-OAM Electromagnetics Panel Report, Jan. 15, 1993; (j) B. Baker; J. A. Spadaro, and R. O. Becker, "Electrical stimulation of articular cartilage," *Ann. N.Y. Acad. Sci.*, Vol. 238, 1974, p. 491-499; (k) C. A. L. Bassett; R. O. Becker, and R. J. Pawluk, "Effects of electric currents on bone *in vivo*," *Nature*, Vol. 204, Nov. 14, 1964, p. 652-654. There are many other publications by Becker, who is a true pioneer.

739. <http://www.cheniere.org>.



740. Kondepudi and Prigogine, {727}, p. 90-91. See also W. Nernst, *A New Heat Theorem*, Dover, New York, 1969.
741. Wang et al., {704}.
742. Maddox, John, *Nature*, 417 (2002), p. 903.
743. Buchwald, Jed Z., *From Maxwell to Microphysics* (University of Chicago Press, 1985), p. 44.
744. For a better meaning of "static" as dynamic but steady state, see Tom Van Flandern, *Phys. Lett. A*, 250 (1998), p. 8-9.
745. E.g., Sen, D. K., *Fields and/or Particles* (Academic Press, 1968), p. vii.
746. Wu, C. S. et al., *Phys. Rev.*, 105, 1957, p. 1413.
747. Weinberg, Steven, *Dreams of a Final Theory* (Vintage Books, Random House, 1993), p. 109-110.
748. Jackson, J. D. and L. B. Okun, *Rev. Mod. Phys.*, 73, 2001, p. 663-680.
749. Kondepudi, Dilip and Ilya Prigogine, *Modern Thermodynamics: From Heat Engines to Dissipative Structures* (Wiley, New York, 1998), p. 459.
750. Jou, D., *Extended Irreversible Thermodynamics* (Springer-Verlag, 1996).
751. Bohren, Craig F., *Am. J. Phys.*, 51, Apr. 1983, p. 323-327. Under nonlinear conditions, a particle can absorb and re-emit more energy than is in the light incident on it. Metallic particles at ultraviolet frequencies are one class of such particles and insulating particles at infrared frequencies are another.
752. Paul, H. and R. Fischer, *Am. J. Phys.*, 51, Apr. 1983, p. 327.
753. See Hal Fox, and Mitchell Swartz (JET Technology, MA), "Progress in Cold Nuclear Fusion - Metanalysis Using an Augmented Database," presented at ICCF-5, Monaco, April 9-13, 1995. The authors extracted information from over 3,000 papers on cold fusion collected by Fox's company. Over 600 of these experiments reported excess heat."

754. E.g., see Petar K. Anastasovski, H. Fox, and K. Shoulders, "A New Approach to the Cosmic Red-Shift and to the Cosmic Microwave Sources," *J. New Energy*, 1 (2), Summer 1996, p. 79-87."