



***The Secret Code  
of  
God***

***Abul Hassan***

## Copy Rights and 19



### **19 – The Secret Code of God**

**By: Abul Hassan**

**2<sup>nd</sup> Edition: 2010**

*No Part of this book may be reproduced in any form or by any means electronic, mechanical, photocopying, recording, or otherwise, without the prior written permission of the publisher or author. However any one can download the electronic version of this book, i.e. free eBook from any website on the internet without our permission for the purposes of reading and research or from our website – [www.ali-pi.com](http://www.ali-pi.com).*

**Abul Hassan**  
**[www.ali-pi.com](http://www.ali-pi.com)**  
**[smabulhassan@gmail.com](mailto:smabulhassan@gmail.com)**  
**[smabulhassan@hotmail.com](mailto:smabulhassan@hotmail.com)**

**Price:**

**US\$ 19.00/CAN\$ 19.00**

## Contents and 19



<i>Topics</i>	<i>Page</i>
<b>1. Copy Rights and 19</b>	<b>2</b>
<b>2. Abul Hassan's Desk and 19</b>	<b>6</b>
<b>3. Dedication and 19</b>	<b>8</b>
<b>4. Coding and 19</b>	<b>9</b>
<b>5. Religions of the world and 19</b>	<b>11</b>
<b>6. Bahai's and 19</b>	<b>12</b>
<b>7. Chinese calendar and 19</b>	<b>13</b>
<b>8. Hinduism and 19</b>	<b>13</b>
<b>9. Symbolism and 19</b>	<b>13</b>
<b>10. Judaism and 19</b>	<b>14</b>
<b>11. Other faiths and 19</b>	<b>17</b>
<b>12. Christianity and 19</b>	<b>18</b>
<b>13. Islam and 19</b>	<b>26</b>
<b>14. Security Code and 19</b>	<b>30</b>
<b>15. Holy Quran and 19</b>	<b>31</b>
<b>16. 99 Names of Allah and 19</b>	<b>75</b>
<b>17. Arabic Alphabets and 19</b>	<b>89</b>
<b>18. Everything and 19</b>	<b>92</b>
<b>19. Re-Appearance of Jesus Christ and 19</b>	<b>96</b>
<b>20. Mathematics and 19</b>	<b>98</b>
<b>21. Mathematical Properties of 19</b>	<b>101</b>
<b>22. Prime Numbers and 19</b>	<b>106</b>

<b>23. Perfect Numbers and 19</b>	<b>115</b>
<b>24. Powerful Numbers and 19</b>	<b>119</b>
<b>25. Enneadecagon and 19</b>	<b>121</b>
<b>26. Pascal Triangle and 19</b>	<b>122</b>
<b>27. Geometry and 19</b>	<b>123</b>
<b>28. Number 1 and 19</b>	<b>124</b>
<b>29. Number 8 and 19</b>	<b>126</b>
<b>30. Number 16 and 19</b>	<b>127</b>
<b>31. Number 57 and 19</b>	<b>128</b>
<b>32. Number 81 and 19</b>	<b>130</b>
<b>33. Number 91 and 19</b>	<b>135</b>
<b>34. Number 110 and 19</b>	<b>138</b>
<b>35. Number 114 and 19</b>	<b>141</b>
<b>36. Magical Table of 19</b>	<b>143</b>
<b>37. Multiples of 19</b>	<b>144</b>
<b>38. Magic Stars and 19</b>	<b>147</b>
<b>39. Magic Hexagon of 19</b>	<b>149</b>
<b>40. Numerology and 19</b>	<b>152</b>
<b>41. Partitions and 19</b>	<b>153</b>
<b>42. Golden Ratio and 19</b>	<b>154</b>
<b>43. Perfect Sphere and 19</b>	<b>163</b>
<b>44. Super Cycle and 19</b>	<b>175</b>
<b>45. Perfect Pi (<math>\pi</math>) and 19</b>	<b>180</b>
<b>46. Perfect Circle and 19</b>	<b>212</b>
<b>47. Number 9 and 19</b>	<b>217</b>
<b>48. Number 6 and 19</b>	<b>218</b>
<b>49. Number 12 and 19</b>	<b>219</b>
<b>50. Number 14 and 19</b>	<b>220</b>
<b>51. Gregorian – Hijri Calendars, Pi and 19</b>	<b>221</b>
<b>52. Chemistry and 19</b>	<b>223</b>
<b>53. Computer Science and 19</b>	<b>232</b>
<b>54. Medical Science and 19</b>	<b>234</b>
<b>55. Astral Body and 19</b>	<b>238</b>



<b>56. Chakra Levels and 19</b>	<b>239</b>
<b>57. Energy and 19</b>	<b>240</b>
<b>58. Plants and 19</b>	<b>241</b>
<b>59. Insects and 19</b>	<b>242</b>
<b>60. Matter and 19</b>	<b>243</b>
<b>61. Engineering and 19</b>	<b>244</b>
<b>62. Time and 19</b>	<b>251</b>
<b>63. Meton Cycle and 19</b>	<b>253</b>
<b>64. Universe and 19</b>	<b>257</b>
<b>65. Music and 19</b>	<b>261</b>
<b>66. Games and 19</b>	<b>262</b>
<b>67. Sports and 19</b>	<b>263</b>
<b>68. Literature and 19</b>	<b>264</b>
<b>69. Age and 19</b>	<b>265</b>
<b>70. Holidays, Observances and 19</b>	<b>266</b>
<b>71. Websites and 19</b>	<b>271</b>
<b>72. World and 19</b>	<b>272</b>
<b>73. Author's Certifications and 19</b>	<b>279</b>
<b>74. Author's Date of Birth and 19</b>	<b>280</b>
<b>75. References and 19</b>	<b>284</b>
<b>76. Highlights of 19</b>	<b>285</b>

## Abul Hassan's Desk and 19



***“There are ten parts of Knowledge. Nine parts belong to the knowledge of Mathematics and one part is the other knowledge.”***

***Prophet Muhammad (PBUH)***

The sole purpose of writing this book is “to Unite” people of all over the world under one common umbrella of Number – 19. There has been so much research on this number in the last 50 years and you may lot of articles and research papers on the amazing results of Number – 19.

One cannot understand the real message of this number which is applying in all fields of life, sciences, mathematics and Holy Books of God if he or she reads a particular research of Number – 19 on only one topic like time or space or chemistry or Holy Book.

I carefully selected the important topics of our world and the role of Number – 19 in those fields and presented before the mankind to understand the real message of Number – 19 which is the special code of our God encoded and encrypted in all the Universe, life, time, sciences, mathematics and in His Holy Books.

Number – 19 is a ‘Universal Point’ which can be seen in all spheres of life in one form or other. It shows all the humans living on this planet that their God is One and all the things created by Him, i.e. Universe, life, time, space, etc are encoded with this special code – 19.

The encoded message of our God in number – 19 in all fields of life and Universe proves a single point that there is a ‘Unity’ in our Universe shown by this special number – 19. The Universe is not showing different pattern of numbers or codes.

In pure mathematics, the mathematicians search for the pattern and symmetry. If they found

some pattern or symmetry, that topic would come under the subject of pure mathematics. Otherwise if it does not show the pattern or symmetry, the topic comes under the subject of applied mathematics.

The pattern and symmetry of Number – 19 in our Universe put this topic under ‘Pure Mathematics’ and we can conclude that this Universe is not the result of an accident. It is the result of the decision of His Creator who made it with some purpose and encoded its symmetry, pattern and perfection with Number – 19.

It would be a great achievement on the part of the mankind if they found common grounds of unity among them by this special Number – 19 and reach realistic conclusions about their life, time and religion after reading this book.

I would like to thanks my publisher for their dedicated services in printing and designing of this book. I would also like to thanks everyone especially my family who has encouraged me in writing and completing this important book. I would also like to thanks all the people who have done a research on this Number – 19 and I have used their efforts and as a reference in this book.

Last but not the least, I would like to thanks my God who has give me courage and wisdom to choose this topic and helped me in discovering lot of facts related to this Number – 19 which a reader would find reading this book.

By the grace of God, I have also discovered the real, rational and perfect value of a famous mathematical constant – Pi which is equal to 19 divided by 6. One may go through the research work on my website – [www.ali-pi.com](http://www.ali-pi.com) for details.

Thanks and Regards

*Abul Hassan*

*12<sup>th</sup> October, 2010*

## Dedication and 19



*“Dedicated to all the Prophets and Infallible persons, who sacrificed their lives to introduce One and Only Almighty God – Allah and His Universal messages of love, peace and justice to all mankind.”*

## Coding and 19



### **Code:**

A code is a rule for converting a piece of information, for example, a letter, word, phrase, sentence or gesture into another form or representation i.e. from one sign into another sign, not necessarily of the same type.

### **Encoding and Decoding:**

In human communications and information processing, Encoding is the process by which information from one source is converted into symbols or in another form to be communicated.

Decoding is the reverse process, converting these code symbols or another form back into information understandable by a receiver. One reason for coding is to enable communication in places where ordinary spoken or written language is difficult or impossible.

### **Cryptography and Secret Codes:**

In cryptography, the codes were once common for ensuring the confidentiality of communications, although ciphers are now used instead.

The Secret codes intended to obscure the real messages, ranging from serious, mainly espionage in military, diplomatic, business, etc. to trivial like romance, games can be of any kind of encoding:

### **Examples of Secret Codes:**

Numbers, flowers, game cards, clothes, fans, hats, melodies, birds, etc., in which the sole requisite is the previous agreement of the meaning by both the sender and the receiver or to hide the meanings and source of the code.

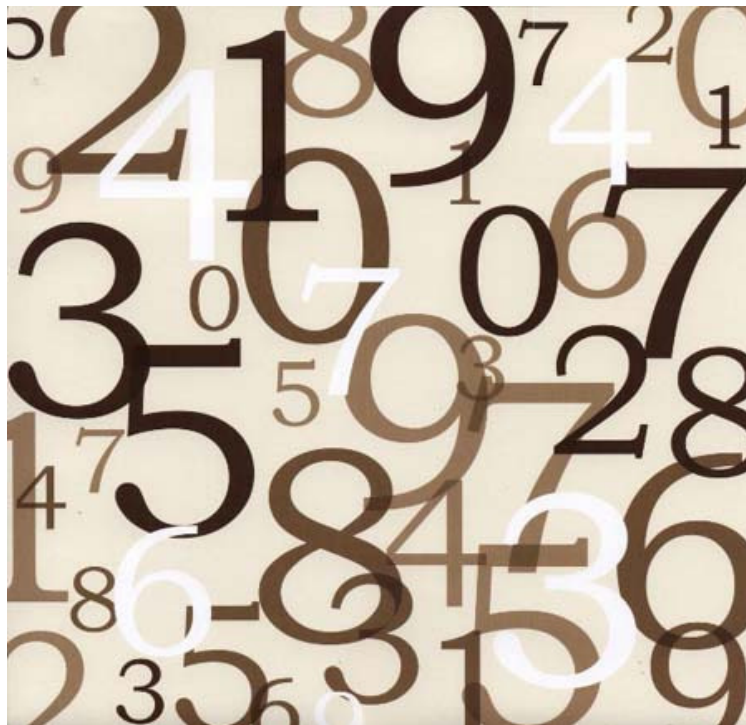
It is usually accepted that in cryptography, a code is a method used to transform a message into an obscured form, preventing those who do not possess special information, or key, required to apply the transform from understanding what is actually transmitted.

### **God and the Secret Code:**

What is the secret code of God? Has He used some secret code in His creations? What is the secret code of his revealed messages or books? Has He used the same code everywhere in the universe? Why He has chosen a Number as a code for His creations and His encrypted and encoded message?

We would see through different aspects in the book to explore the secret code of God. We would see different religions of the world and His application in those religions. We would see the application of His code in mathematics, medical science, engineering, chemistry, and in our daily lives.

### **What is the Secret Code of God?**





## Religions of the World and 19



*“This discussion would be unprofitable if it did not lead us to appreciate the wisdom of the our Creator, and the wondrous knowledge of the Author of the world, Who in the beginning created the world out of nothing and set everything in number, measure and weight, and then in time and age of man formulated a science which reveals fresh wonders the more we study it.”*

Hrovista of Gondersheim

### God’s Signature and 19:

Number Nineteen (19) is the numerical or gematrical value of the word 'ONE' in all the scriptural languages, Aramaic, Hebrew and Arabic. The number 19 therefore proclaims the First commandment in all the scriptures: that there is only **ONE GOD**.



$$19 = 1 + 9 = 10 = 1 + 0 = 01 \text{ ----- One}$$

$$19 = 01$$

Deuteronomy 6:4-5, " Hear O Israel the Lord our God is one Lord and thou shalt love the Lord thy God with all thine heart, and with all thy soul, and with all thy might."

Mark 12:29, " And Jesus answered him, The first of all the commandments is, Hear, O Israel; The Lord our God is one Lord:"

**Quran 2:163, " And your God is one God: there is no god but He, most Gracious, most Merciful."**

## **Bahai's and 19**



- The Baha and his disciples formed a group of 19 and there were 19 Apostles of Baha'u'llah.
- The centerpiece of Bahá'í community life is the 19-Day Feast.
- The Bahá'í calendar is made up of 19 months of 19 days each.
- The Bábí and Bahá'í faiths, a group of 19 is called a *Váhid*, a Unity (Arabic:*wāhid*, "one"). The numerical value of this word in the Abjad numeral system is 19.

### **Baha'i Calendar:**

The Bahá'í calendar is structured such that a year contains 19 months of 19 days each (along with the intercalary period of Ayyám-i-Há), as well as a 19-year cycle and a 361-year (19x19) super cycle. The period of Ayyam-i-Ha (Intercalary Days) adjust the Bahá'í year to the solar cycle. The Nineteen Day Fast is held during the final month of 'Alá' (2 March – 20 March), and is preceded by the intercalary days, known as Ayyám-i-Há. In addition, the intercalary days include 28 February and 1 March, causing precise synchronization of the 19 months with the Gregorian calendar.

**(19 months x 19 days = 361) ..... Super Cycle**

### **Ancient Sweden and 19**

In ancient Sweden the dates of the full moon were computed by runic calendar sticks (runstavar) with the full moon marked only at **19 fixed dates** within each month.

**Full Moon ---- 19 fixed dates**



## Chinese Calendar and 19

Every 19 years the intercalary month of Chinese calendar is inserted after the **eighth month** and is called "ren ba yue" (double August). It predicts tragedy and death in popular tradition.

*Every 19 years – intercalary month of Chinese calendar is inserted after the 8<sup>th</sup> month.*

**Number – 19 is the 8<sup>th</sup> Prime Number**

## Hinduism and 19



The Mandala - 9 of the *Rig-Veda* is comprised of 114 hymns, entirely devoted to Soma Pavamana, the plant of the sacred portion of the Vedic religion.

**114 hymns of Rig – Veda = 19 x 6**

## Symbolism and 19



- This number is in relation with the Son of God, according to Abellio.
- According to R. Allendy, "it is the unit being established in the universe, 10, between the multiplied parts and by an act of reciprocal solidarity, 9. Thus is constituted and appeared the cosmic individuality,  $1 + 9 = 10 = 1$ ".
- It represents "the number of the star which illuminates the intelligence, invigorates the innocents or the pure hearts, illustrated by children playing in the garden of the humanity, when the peace is made between the empires", according to Charrot.
- It symbolizes the harmony, the knowledge acquired by the sun and which goes of par with the moon, according to Creusot.
- In Japan, 19 is a sign carrying misfortune because it is said JUKU, which means also "sorrows repeated".

## Judaism and 19



The following quotation is also taken from 'Studies in Jewish Mysticism', (Association for Jewish Studies, Cambridge, Mass., Joseph Dan and Frank Talmage, eds., Page 88, 1982). The quotation refers to the work of **Rabbi Judah the Pious (12th Century AD)**:

"The people (Jews) in France made it a custom to add (in the morning prayer) the words: "**Ashrei temimei derekh** [ blessed are those who walk the righteous way ]," and our Rabbi, the Pious, of blessed memory, wrote that they were completely and utterly wrong. It is all gross falsehood, because there are only nineteen times that the Holy Name is mentioned [ in that portion of the morning prayer ].... and similarly you find the word '**Elohim nineteen times in the pericope of Ve-'elleh shemot** .....Similarly, you find that Israel were called "sons" nineteen times, and there are many other examples. All these sets of nineteen are intricately intertwined, and they contain many secrets and esoteric meanings, which are contained in more than eight large volumes. Therefore, anyone who has the fear of God in him will not listen to the words of the Frenchmen who add the verse, '**Ashrei temimei derekh**', and blessed are the righteous who walk in the paths of **God's Torah**, for according to their additions the Holy Name is mentioned twenty times.... and this is a great mistake.

Furthermore, in this section there are **152 words (19 x 8 =152)** but if you add, 'Ashrei temimei derekh', there would be 158 words. This is nonsense, for it is a great and hidden secret why there should be 152 words.... but it cannot be explained in a short treatise.....In order to understand this religious phenomenon, we have to take the basic contention of this treatise exactly as it is stated: every addition or omission of a word, or even of a single letter, from the sacred text of the prayers destroys the religious meaning of the prayer as a whole and is to be regarded as a grave sin, a sin which could result in external exile for those who commit it....."

(Studies in Jewish Mysticism, pp. 88-89)

Important thing to note that 19 is the 8<sup>th</sup> Prime number and the Number – 152 is a multiple of 19 and 8. **152 = 19 x 8** and the root number of 152 is also 8 as: **152 = 1 + 5 + 2 = 8**

Rabbi Moshe ben Nachman writes about the encoding of Torah as:

**“Everything that was transmitted to Moses our teacher through the forty-nine gates of understanding was written in the Torah explicitly or by implication in words, in the numerical value of the letters or in the form of the letters, that is, whether written normally or with some change in form, such as bent or crooked letters, and other deviations.....”**

(Ramban 1971, Vol.1, p. 10)

**“The Hebrew Bible often speaks the language of numbers and measurements.”**

**(Feldman 1965)**

### **Jews Calendar and cycle of 19:**

Secondly, the number of years in each cycle of intercalated Hebrew calendar in which 7 of the 19 years are leap years. In Hebrew or Jewish calendar, Leap years follow a 19 year schedule in which years 3, 6, 8, 11, 14, 17 and 19 are leap years. The Hebrew year 5758 (which starts in the Gregorian year 1997) is the first year of a cycle. 19 years is the same as 235 lunations in Hebrew calendar calculations. The Hebrew calendar is computed by lunations

### **Hebrew Alphabets:**

The system of Hebrew numerals is a quasi-decimal alphabetic numeral system using the letters of the 27 Hebrew alphabets. In this system, there is no notation for zero, and the numeric values for individual letters are added together.

### **Gematria:**

Each unit (1, 2, ..., 9) is designated a separate letter, each tens (10, 20, ..., 90) a separate letter, and each hundreds (100, 200, ..., 900) a separate letter. **Gematria** (Jewish numerology) uses these transformations extensively in the calculations. The Hebrew numeric system operates on the additive principle in which the numeric values of the letters are added together to form the total. For example, 177 is represented as **קעז** which corresponds to  $100 + 70 + 7 = 177$ .

### **27 Hebrew Letters:**

Mathematically, the Hebrew system requires **27 letters**. The last letter, *tav* (which has the value 400) is used in combination with itself and/or other letters from *kof* (100) onwards, to generate numbers from 500 and above. Alternatively, the 22-letter Hebrew alphabet is sometimes extended to 27 by using 5 *sofeet* (final) forms of the Hebrew letters.

Conventionally, the **numbers 15 and 16** are represented as **ט"ו (9+6) and ט"ז (9+7)**, respectively. This is done in order to refrain from using the two-letter combinations **יח (10+5) and יז (10+6)** which are alternate written forms for the Name of God) in everyday writing.

## 27 - Hebrew Alphabets and their numeric value:

Decimal	Hebrew	Glyph
1	<i>Aleph</i>	א
2	<i>Bet</i>	ב
3	<i>Gimel</i>	ג
4	<i>Dalet</i>	ד
5	<i>He</i>	ה
6	<i>Vav</i>	ו
7	<i>Zayin</i>	ז
8	<i>Het</i>	ח
9	<i>Teth</i>	ט
10	<i>Yod</i>	י
20	<i>Kaph</i>	כ
30	<i>Lamed</i>	ל
40	<i>Mem</i>	מ
50	<i>Nun</i>	נ
60	<i>Samekh</i>	ס
70	<i>Ayin</i>	ע
80	<i>Pe</i>	פ
90	<i>Tsadi</i>	צ
100	<i>Qoph</i>	ק
200	<i>Resh</i>	ר
300	<i>Shin</i>	ש
400	<i>Tav</i>	ת
500	<i>Tav Kof or Kaf Sofit</i>	ך or ק"ת
600	<i>Tav Resh or Mem Sofit</i>	ם or ר"ת
700	<i>Tav Shin or Nun Sofit</i>	ן or ש"ת
800	<i>Tav Tav or Pe Sofit</i>	ף or ת"ת
900	<i>Tav Tav Kof or Tsadi Sofit</i>	ץ or ק"תת

## Other Faiths and 19



- The oldest cabalistic text which has remained is the "Sepher Yetzirah" (Book of the Creation), usually attributed to the Jewish rabbi Akiba ben Joseph (50 to 132 after J.-C.). But the doctrine was developed to the Middle Ages in the "Sepher ha-Zohar" (Book of the Splendor), collection of 19 works of periods and different authors.
- 19 are the number of days, following the resurrection of our "Crestos", where is torn off by the Celestial Hierarchies, an atomic substance of the astral counterpart of our belly. This layer, Samael Aun Weor considers it as the door of the hells of the man. When it is closed, it maintains the human soul captive in the abysses of the evil.
- Gautama Buddha was 19 years old when he left the palace of his father and he went to search wisdom.
- According to Edgar Cayce, the birth of Christ would have occurred the 19<sup>th</sup> day of March.
- There are in Quebec 19 dioceses.
- The rites and symbolisms common to the various Khmer ceremonies identify 19 vital spirits, or "Proloeung".
- Anniversary of marriage: bronze weddings.
- The staircase of "Member", the pulpit of the "iman", has nineteen steps.

## Christianity and 19



- 19 is the sum of the twelve apostles and the seven deacons of the incipient Church.
- The 19 chapters of the book of the Wisdom of the Ancient Testament.
- The 19 sons of David who were born to him when he was in Hebron and in Jerusalem. (1 Ch 3,1-9)
- The 19 strong towns of the tribe of Naphtali. (Jos 19,38)
- The number 19 is used 6 times in the Bible.
- The word star is used 19 times in the New Testament and the word creature, 19 times in the Bible.

The Holy Bible is one of the most famous scriptures and accepted as a Divine Book. Bible is considered as the Divine Seal and capstone of God's word by the Christians of the world.

Mr. Richard Amiel McGough wrote a book, "**The Bible Wheel**" on the numerical structure of Bible. He is considered as one of the most respected and reputed Christian scholar and philosopher of our times.

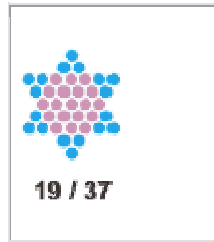
He described the importance of Number -19 in Bible as:

"The **number – 19** is considered as a '**Physical Manifestation**' in Bible. The two important verses in relation with 19 are:

**"And Adam called his wife's name Eve; because she was the mother of all living."**  
(Genesis 3.20)

**"Heaven and earth shall pass away: but my words shall not pass away."**  
(Mark 13.31)

**The Number 19** is the Hexagon in the Hexagon/Star pair **19/37** which appears in the heart of Genesis 1.1 - **the Creation Holograph**:



It forms the six-fold double-hexagonal core of the **Logos Star**. (Source: *The Bible Wheel* by Richard Amiel McGough)

**The Heart = HaLev (Hebrew) = 19 – Ordinal Value ( 5 + 12 + 2 = 19)**

The Heart הלב HaLev	$19 = 5 + 12 + 2$ (Ordinal Value)	
	$37 = 5 + 30 + 2$ (Standard Value)	

The Number 19 is the basis of the **Grace Manifest Holograph**. It is related to the ideas of Physical Manifestation and the Flesh .19 plays a major and central role in the course of World History with the rise of Materialism in the 19<sup>th</sup> Century.

The link of 19 to all of the Physical Manifestation and Flesh is illustrated in the pair of identities:

**Eve – Chavah(Hebrew) = 19 = The Earth = He Gai(Hebrew)**

Eve	= 19 =	The Earth
חַוָּה		הַאֲרֶצֶת
Chavah		He Gai

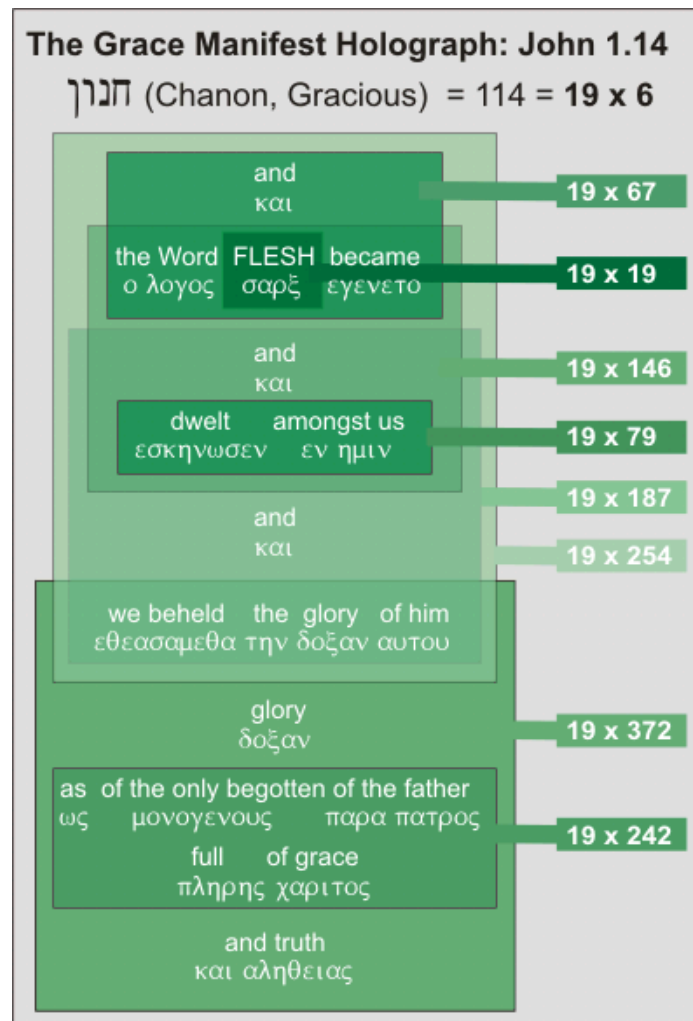
It also integrates with the universal concept of ‘Mother Earth’ and the feminine nature of physical manifestation. It is signified in this identity:

Rib(Gen 2.22) = Tsalo(Hebrew) = 190 = Sum(19)

Rib [Gen 2.22]  
 צלע = 190 = Sum (19)  
 Tsalo

The Number 190 is the 19<sup>th</sup> Triangular Number, which integrates with the word 'Rib' with the numeric value of Eve. **The Holograph and the Number – 19:**

- The holograph consists of eight nested word clusters that each sum to a multiple of the Number 19, as does the verse index. All the words enclosed in each shaded box are **multiples of the prime Number 19**.
- The verse is called the **Grace Manifest Holograph** for a number of inter-related reasons. First of all, it is the theme of the plain text which speaks of the manifestation of the Word in the flesh, *full of grace and truth*.



www.BibleWheel.com

(Reference: [www.Biblewheel.com](http://www.Biblewheel.com))



## Major Identities in Bible based on Number-19:

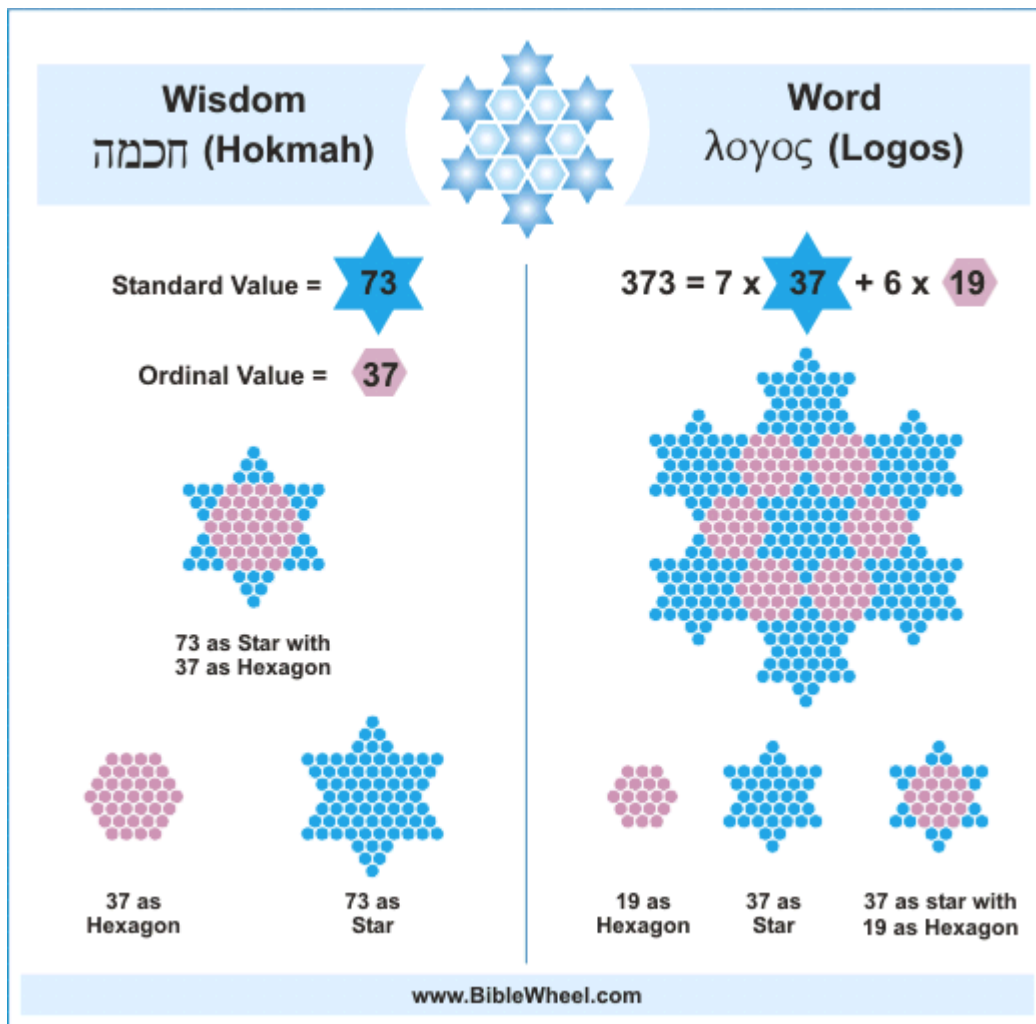
The primary identities based on the Number 19:

The Number 19
Quph (Ord) ק
Behold! [Jn 1.29] יֵדַע Idei
The Earth [Mark 13.31] הַיָּמִינִים Hay Gai
The Heart (Ord) לֵב HaLev
Flame (Ord) לֶהֱבֵא Lahev
Eve [Gen 3.20] חַוָּה Chavah
Her Hand יָדָהּ Yadah
Trust בֵּטַח Betach
Praise יָדָהּ
He shall come [Ps 24.] יָבוֹא Yibo

(Source: *The Bible Wheel* by Richard Amiel McGough)

1. Hebrew Letter – Quph = 19 - ‘Quph’ is the Nineteenth letter in Hebrew.
2. The Earth (Mark 13.31) = 19 = Hay Gai(Hebrew)
3. Behold (Jn 1.29) = 19 = Idei(Hebrew)
4. Praise = 19
5. Trust = 19 = Betach(Hebrew)
6. The Heart(Ord.) = 19 = HeLav(Hebrew)
7. Flame(Ord.) = 19 = Lahev(Hebrew)
8. Eve(Gen 3.20) = 19 = Chaveh(Hebrew)
9. Her Hand = 19 = Yadah(Hebrew)
10. He shall come(Ps 24.) = 19 = Yibo(Hebrew)

The **Number-19** is the number of **Physical Manifestation**. It appears relatively in the Grace Manifest Holograph in eight (8) nested word clusters. And Number -19 is also the 8<sup>th</sup> Prime number in Mathematics or we can say 8 is the Prime Index of Number -19 and **Number-19** is the centered **Hexagonal Number**.



(Source: *The Bible Wheel* by Richard Amiel McGough)

Then the Number 532 is a Pentagonal Number and its Index number is 19, i.e. 532 is the **19<sup>th</sup>** Pentagonal Number. Number 532 is the numerical value of ‘**Alpha**’ – the symbol of Almighty God – and many of His Titles, such as, ‘The Holy Lord God’.”

The above paragraphs and pictures are the condensed context of the great efforts done by Richard Amiel McGough on numerical structure and encoding of Bible.

### **19 x 19 and Bible Wheel:**

Mr. Richard Amiel McGough mentions in his famous book, “The Bible Wheel” about the Number 361 or 19 x 19 and its significance in Bible as:

**“The next day John seeth Jesus coming unto him, and saith, Behold the Lamb of God, which taketh away the sin of the world.”**

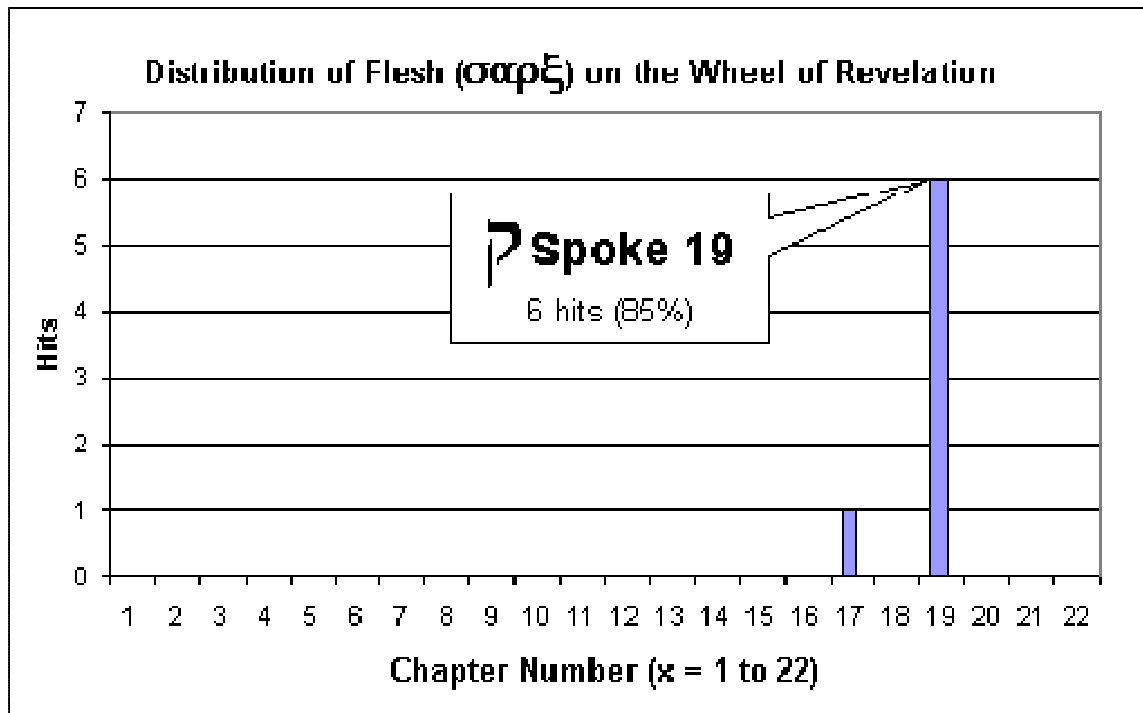
**(John 1.29)**

### **The Number – 361 – The Flesh:**

The Number 19 is the Number of Flesh and Physical Manifestation. It is the basis of the Grace Manifest Holograph. It is the square root of the Number- 361 = 19 x 19. The distribution of this word is significantly maximized in Revelation 19 of the Inner Wheel of Revelation. The fundamental force of the Nineteenth (19) Hebrew Letter – Quph manifests in the course of World History in the Materialism of the Nineteenth -19<sup>th</sup> Century.

### **Factors: 19 x 19**

1. Flesh (Jn 1.14)
2. Lamb (Jn 1.29)
3. Mount Zion (Ps 48.3)
4. In the land of the living (Ps 27.13)
5. Come up to me into the mount (Ex 24.12)
6. From the heart (Rom 6.17)
7. By the hand of Moses (2Chr 34.1)
8. Andrew (S# 406)
9. Jambes (S# 2387)



The Number – 19 x 19 = 361 is illustrated in following words and sentences in Bible:

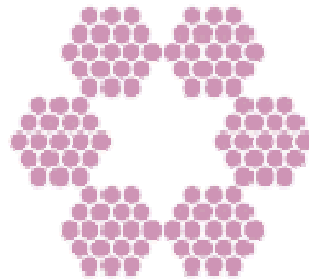
**19 x 19 and Biblical words:**

The Number 361
Flesh [Jn 1.14] σάρξ
Lamb [Jn 1.29] αμνος
Mount Zion [Ps 48.3] הר ציון
Come up to me into the mount [Ex 24.12] עלה אלי ההרה
In the land of the living [Ps 27.13] בארץ חיים

<p>From the heart [Rom 6.17]</p> <p>εκ καρδιας</p>
<p>By the hand of Moses [2Chr 34.1]</p> <p>בִּיד מֹשֶׁה</p>
<p>Andrew [S# 406]</p> <p>Ανδρεας</p>
<p>Jambres [S# 2387]</p> <p>Ιαμβρης</p>

(Source: *The Bible Wheel* by Richard Amiel McGough)

- The **Number 114** is represented by the **six fold heart** of the sevenfold **Logos Star**:



$$114 = 6 \times 19$$

- **19** is the smallest prime number mentioned **6** times in the Holy *Bible*.
- The number of Sayings of Jesus Christ listed in the Gospel of Thomas is **114**.

**Sayings of Jesus Christ in Gospel of Thomas-----114**

$$114 = 6 \times 19$$

## Islam and 19



***“Over it is Nineteen.”***

*(Chapter – 74, Verse – 30, Holy Quran)*

### **The Holy Quran and Nineteen – 19:**

In Chapter 74, Verses 30-37 of Quran, the Last Holy Book of Islam mentions:

**"Over it is Nineteen.** We appointed angels to be guardians of Hell, and we assigned THEIR NUMBER (i.e. 19) to disturb the disbelievers, to convince the Christians and Jews (that this is a divine scripture), to strengthen the faith of the faithful, to remove all traces of doubt from the hearts of Christians, Jews, as well as the believers, and to expose those who harbor doubt in their hearts, and the disbelievers; they will say, "What did God mean by this allegory?" God thus sends astray whomever He wills, and guides whomever He wills, None knows the soldiers of your Lord except He. This is a reminder for the people. Absolutely, (I swear) by the moon. And the night as it passes. And the morning as it shines. This is one of the great miracles. A warning to the human race. For those among you who wish to advance or regress."

**(Translated by: Rashad Khalifa)**

These verses tell us that the number Nineteen (19) was designated by God to prove that Quran is from God and that as the instrument of authentication, it is a great miracle. The miracle of the Quran resides in the very structure of its text, in its orthographic and numerical arrangement.

**Dr. Rashad Khalifa**, a bio-chemist from the USA decoded the significance of nineteen (19) in Quran. The momentous discovery that nineteen (19) is the Quran's common denominator became a reality in January 1974.

In his appendix entitled '19: **The Creator's Signature**' (Ibid. p.709) **Khalifa** writes:

'The scriptures are not the only mathematically composed creations of God where the number 19 is the common denominator. A plethora of scientific findings have now shown that the number 19 represents God's signature upon his creations. This divine stamp appears throughout the universe in much the same manner as the signatures of Michelangelo and Picasso identify their

works. For example, the Sun, the Moon and the Earth become aligned in the same relative positions once every 19 years.”

In 1983, Canadian Council on the Study of Religion reported in its Quarterly Review of April 1983 that the code of Khalifa discovered is “*an authenticating proof of the divine origin of the Quran.*”

**Rashad Khalifa** further writes:

“The **discovery of mathematically coded scripture** assures us that the verses, words, letters and all parameters of the original scripture were written down in accordance with an intricate pattern that is clearly superhuman. Like an ancient time capsule, the code remained hidden until our knowledge grew sophisticated enough to decode its intricacies. This code was deciphered by computers.

The idea of mathematically composing a literary work is certainly novel to human thinking and unique to the scriptures. The numerical pattern serves both as an authenticating tool and as a guard to protect and preserve the scripture. Obviously finding original, unaltered scripture is of crucial importance. The slightest change in the text of a mathematically coded literary work would disrupt or utterly destroy such a code; the mathematical pattern would simply disappear.”

From a purely mathematical point of view, the slightest change renders the pattern non-existent, 114, for example, is a multiple of 19, but 113 or 115 is not.

Mathematical composition of a literary work is a totally new concept, though we now realize it has existed for centuries in sacred writings.

The Quran, which was revealed in A.D. 610-630, is the only scripture that is known to still exist in its original language and form. It is also the only book known to be mathematically coded throughout. All the parameters of the Quran - the numbers and sequence of chapters, the number of verses, the number assigned to each verse, the number of words, the number of certain specified letters, the number of words from the same root, the number and variety of divine names, the absence of one or more letters from a word, verse or chapter, the unique and often strange spellings of certain crucial words and many other elements are all authenticated by its mathematical code - 19.



**Quran –The Last Holy Book of Islam revealed on Holy Prophet Muhammad (PBUH)**

When the Quran was revealed, 14 centuries ago, the number system known today did not exist. An alphabetic system was utilized whereby the letters of the Arabic, Hebrew, Aramaic, Greek and Roman alphabets were used as numerals. The Roman numeral system (I, V, X, C, etc) is still used extensively today. The number assigned to each letter is its '*Gematrixal Value*'.

The Quran is characterized by a unique phenomenon never found in any human authored book. Every element of the Quran is mathematically composed. There are two major facets of the Quran's mathematical system:

1. The mathematical literary composition and
2. The mathematical structure involving the numbers of suras and verses.

### Abjad Numerals:

The '*Abjad Numerals*' are a decimal numeral system which was used in the Arabic-speaking world prior to the use of the Hindu-Arabic numerals from the 8th century, and in parallel with the latter until Modern times. In the Abjad system, the 28 letters of the Arabic alphabet are assigned numerical values, based on the '*Abjadi order*'.

For example, the first letter of the Arabic alphabet, 'Alif' is used to represent 1, the second letter, 'Ba' is used to represent 2, etc. Individual letters also represented 10's and 100's, for instance, the Arabic letters, 'Ya' for 10 , 'Kaf' for 20 and 'Qaf' for 100, etc.

The word 'abjad' itself derives from the beginning of the order of the letters in the proto-Canaanite alphabet, Phoenician, Aramaic alphabet and Hebrew.

								ا 1
ي 10	ط 9	ح 8	ز 7	و 6	ه 5	د 4	ج 3	ب 2
ق 100	ص 90	ف 80	ع 70	س 60	ن 50	م 40	ل 30	ك 20
غ 1000	ظ 900	ض 800	ذ 700	خ 600	ث 500	ت 400	ش 300	ر 200

*28 - Arabic alphabets with their numeric values*



In early Islamic times, these numbers were used by mathematicians. In modern Arabic, they are primarily used for numbering small quantities, such as items in a list. They are also used to assign numerical values to Arabic words.

## **28 Arabic Alphabets and 19:**

If we sum the numeric values of all the 28 Arabic Alphabets, their sum comes to 5995.

**Sum of 28 Arabic Alphabets = 5995. Number 59 is also the reversal number of 95.**

Now if we add the numbers of 5995, we see:

$$5995 \dots 5 + 9 + 9 + 5 = 28 \dots 28 \text{ Arabic Alphabets}$$

The cube of 19 is:  $19 \times 19 \times 19 = 6859$ . Now if we add the numbers of 6859, we see:

$$6859 \dots 6 + 8 + 5 + 9 = 28 \dots 28 \text{ Arabic Alphabets}$$

*Number – 28 is the 2<sup>nd</sup> Perfect Number in Mathematics  
28 – 2<sup>nd</sup> Perfect Number*

*(1 + 2 + 4 + 7 + 14 = 28.....The sum of the divisors of the number equals to that number----- That number would be Perfect Number in Mathematics)*

- Number – 2819 is a Prime Number

**2819.....Prime Number**

People all over the world know that:

**Faith and figures are irrefutable if faith is confirmed by figures and figures are confirmed by the faith simultaneously.**

## Security Code and 19



It is accepted in all the religions that the messengers of God i.e. the Prophets of God and the messages sent by Him i.e. revealed books and booklets in different eras were usually not accepted by the majority of the people and they refused to accept them as the messengers of God and the message of God.

With time, the evil minded people also tried to change the holy books by adding and subtracting new sentences, phrases, and even new chapters to destroy the real message of God.

In His last Holy Book, The Almighty God insured that His message should not be changed or distorted by these evil minded people and so He encoded and encrypted His last Message – the Holy Quran with His secret code – 19.

19 is the **Prime Number**, i.e. 19 can be divided only by itself and by 1. Prime Numbers are mostly the preference of intelligence services, banks, security companies, financial institutions, etc to form a security code. If the security code is a composite number, then it would be debatable whether the security code is formed by that composite number or its multiples.

For example, the multipliers of 21 are 7 and 3. If the number 21 is taken as security code, then it would be questioned which number form the security code, since every number that is a multiple of 21 is a multiple of 7 and 3. So Number – 19 fulfills the requirement of a ‘Security Code.’

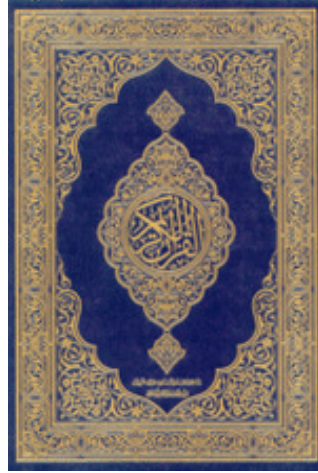
### **Digit Summing:**

It means to reduce a number or word by a process known as digit summing and then reach conclusions based on the single digit that is produced. As the name implies, it involves taking the sum of all the digits in a number and repeating the process as necessary until a single-digit answer is produced. For a word, the values corresponding to each letter’s place or value in the alphabet or language are summed.

For example in English letter numeric value:

**Hello -----  $8 + 5 + 12 + 12 + 15 = 52 = 5 + 2 = 7$**

## The Holy Quran and 19



*The Holy Quran*

“Allah has appointed a measure for all things.” (Sura at-Talaq, 3)

$$19 \text{ ----- } 1 + 9 = 10 \text{ ----- } 1 + 0 = 01$$

$$19 = 01$$

*“There is no God (0) except One (1) Allah” is the translation of the ‘Kalima’ of all Muslims of the world “لا إله إلا الله”. In English, “La Ilah ila Allah”*

### 19 – The Common Denominator of the Holy Quran

The Holy Quran is the 19th Scripture and the Last Holy Book of Islam and the Almighty God. Here is the proof of it:

1. The Quran consists of 114 suras (chapters), which is:

The number of suras in the Quran	114 (19x6)
----------------------------------	------------

2. The first verse (1:1), known as 'Basmalah' consists of 19 letters.



ب	1st letter	ا	8th letter	ل	15th letter
س	2nd letter	ل	9th letter	ر	16th letter
م	3rd letter	ر	10th letter	ح	17th letter
ا	4th letter	ح	11th letter	ى	18th letter
ل	5th letter	م	12th letter	م	19th letter
ل	6th letter	ن	13th letter		
ه	7th letter	ا	14th letter		

3. The 'Basmalah' occurs 114 times, despite its conspicuous absence from Sura 19 (it occurs twice in Sura 27) –

The number of Basmalahs in the Quran	114 (19 x 6)
--------------------------------------	--------------

'Basmalah' is the group of 4 words which has a special place in the Quran. The number of letters and the number of repetitions of the Basmalah are again related to the code 19. Basmalah consists of 4 words. These words are **1.Name 2.God 3. Gracious and 4.Merciful** respectively.

The word	number of occurrence
Name	19 (19x1)
God	2698 (19x142)
Gracious	57 (19x3)
Merciful	114 (19x6)
The total of the coefficients of these words	

Besides these 4 words in Basmalah are multiples of 19, it is also important that the total of the **coefficients of these words** is 152 (19x8) [Name(1)+God(142)+Gracious(3)+Merciful(6)]=152.

**152 = 19 x 8 .....19 is the 8<sup>th</sup> Prime Number.**

God displays the miracle and intactness of the Quran with these words. The coefficients of these words are multiples of 19. This confirms once again the correctness of the operation (The number “8” among these coefficients has a special meaning. When we multiply 19 with 8, it makes 152 and this number exists in all the coefficients in the Basmalah so to say. We have seen that one of the most important characteristics of 19 is that it is a prime number. If you want to know where 19 stands in the order of prime numbers let us write all the prime numbers till 19.

The order of prime numbers	1	2	3	4	5	6	7	8
The prime numbers	2	3	5	7	11	13	17	19

**A prime number is an integer that is not divisible without remainder by any other integer except 1 and that integer itself.**

The number of verses where at least one of the 4 words Of Basmalah is used	1919 (19x101)
--	---------------

Let us examine the words forming Basmalah and the numerical value of them.

Number	Letters of the words	Number of Letters	Mathematical Value	Total
1	Ba,Seen,Meem	3	2, 60, 40	102
2	Alif,Lam,Lam,He	4	1, 30, 30, 5	66
3	Alif,Lam,Ra,Ha,Meem,Noon	6	1, 30, 200, 8, 40, 50	329
4	Alif,Lam,Ra,Ha,Ya,Meem	6	1, 30, 200, 8, 10, 40	289
total		19	-	786

**The numerical value of the words “God”, “Al-Gracious”, “Al-Merciful” which form the names of God in Basmalah is a multiple of 19.**

The numerical value of God’s names which form Basmalah			
Allah - God	Al-Gracious	Al-Merciful	Total
66	329	289	684 (19x36)

4. The total number of verses in the Quran is 6346. 6234 numbered verses and 112 un-numbered verses (Basmalabs) = **6346**.

$$6 + 3 + 4 + 6 = 19$$

If we diagnose the Number – 6346

$$6346 \dots\dots\dots 63 \dots\dots 46$$

The reversal of the number – 63 is 36 and the reversal of the number 46 is 64.

$$63 \dots\dots\dots 36 = 6 \times 6$$

$$46 \dots\dots\dots 64 = 8 \times 8$$

All the Perfect Numbers in Mathematics end either with Number – 6 or Number – 8.

*Number – 19 is 8<sup>th</sup> Prime Number in Mathematics.*

5. From the missing Basmalah of Sura (chapter) 9 to the extra Basmalah of Sura 27, there are precisely -- **19 Suras (chapters)**.

1	2	3	4	5	6	7	8	9	10	11	12	13	14	15	16	17	18	19
9	10	11	12	13	14	15	16	17	18	19	20	21	22	23	24	25	26	27

**“It is from Solomon and it is in the name of God, gracious, merciful.”  
Quran - (Chapter – 27, Verse – 30)**

And if we add the verse number which is 30 and the 27 of the 27th sura, we have

$$30 + 27 = 57 = 19 \times 3$$

The sura number where we find the missing Basmalah	the verse number of Total the missing Basmalah	total
27	30	57 (19x3)

6. It follows that the total of the sura(chapter) numbers from 9 to 27 are (9+10+11+12+13+.....+25+26+27) is 342.

$$342 = 19 \times 18$$

The total of the suras from the sura where there is no Basmalah to the sura where the lost Basmalah is found	342
The word number from the beginning of the sura "The Ant" till the verse where the lost Basmalah is found	342 (19x18)

7. The 'Abjad' numeric value of the Arabic word '**Majeed**', used in the first verse of Sura (chapter) Qaf is **57 = 19 x 3**.

The numerical value of the word "Majeed"				
Meem	Jeem	Ya	Da	total
40	3	10	4	57 (19 x 3)

8. Sura (chapter) 96, first in the chronological sequence, consists of **19 verses**.

### **Sura – 96 – 19 verses**

9. This first chronological Sura is placed atop the last - **19 suras**.

When we start to count back from the end of the Quran up to 19, we come across with the sura Alaq (The Hanging). The number of the verses of the sura Hanging is 19.

How many verses are in the number 19th sura from the end?	19
---	----

10. Sura 96 consists of 304 Arabic letters and 304 equals **19 x 16**.

### **304 Arabic words = 19 x 16**

11. 14 different Arabic letters form 14 different sets of "Quranic Initials" such as A.L.M. of 2:1 and prefix 29 suras(chapters).These numbers add up to  $14 + 14 + 29 = 57 = 19 \times 3$

$$57 = 19 \times 3$$

12. The Quranic initials occur is  $2 + 3 + 7 + \dots + 50 + 68 = 822$  and  $822 + 14$  sets of Quranic initials equals  $836 = 19 \times 44$ .

$$836 = 19 \times 44$$

There are 14 forms of initial letters in the Quran and the total number of initial letters in these forms is  $38 = 19 \times 2$ . And if we multiply the serial numbers of these forms and the number of the initial letters in each form and then add all these results, it makes up **247 = 19x13**.

Row number	Initial letters	Number of letters in the group	The multiplication of the row number and the number of letters
1	Alif-Lam-Meem	3	1x3=3
2	Alif-Lam-Meem-Sad	4	2x4=8
3	Alif-Lam-Ra	3	3x3=9
4	Alif-Lam-Meem-Ra	4	4x4=16
5	Kaf-He-Ya-Ayn-Sad	5	5x5=25
6	Ta-He	2	6x2=12
7	Ta-Seen-Meem	3	7x3=21
8	Ta-Seen	2	8x2=16
9	Ya-Seen	2	9x2=18
10	Sad	1	10x1=10
11	Ha-Meem	2	11x2=22
12	Ha-Meem-Ayn-Seen-Qaf	5	12x5=60
13	Qaf	1	13x1=13
14	Noon	1	14x1=14
Total		38 (19x2)	247(19x13)

13. Between the first initialed sura (chapter) 2 and the last initialed sura(chapter) 68 there are 38 un-initialed suras -  $19 \times 2 = 38$ .

$$38 = 19 \times 2$$

14. Between the first and last initialed sura(chapter) there are 19 sets of alternating 'initialed' and 'un-initialed' suras.

### 19 sets of alternating initialed and un-initialed suras

15. The famous first revelation (96:1-5) consists of 19 words.

### First Revelation (96: 15) --- 19 words



خَلَقَ	الَّذِي	رَبِّكَ	بِاسْمِ	اقْرَأْ
5th word	4th word	3rd word	2nd word	1st word
	عَلَى	مِنْ	الْإِنْسَانَ	خَلَقَ
	9th word	8th word	7th word	6th word
	الْأَكْرَمِ	رَبِّكَ	وَ	اقْرَأْ
	12th word	11th word		10th word
		بِالْقَلَمِ	عَلَّمَ	الَّذِي
		15th word	14th word	13th word
	لَمْ يَعْلَمْ	مَا	الْإِنْسَانَ	عَلَّمَ
	19th word	18th word	17th word	16th word

### 19 Arabic Words

16. This 19- worded first revelation consists of 76 letters -  $19 \times 4 = 76$ .

$$76 = 19 \times 4$$

17. The last revelation - **Sura (chapter) 110** consists of 19 words.

وَالْفَتْحُ	اللَّهُ	نَصْرُ	جَاءَ	إِذَا
5th word	4th word	3rd word	2nd word	1st word
دِينِ	فِي	يَدْخُلُونَ	النَّاسِ	وَرَأَيْتَ
10th word	9th word	8th word	7th word	6th word
			أَفْوَاجًا	اللَّهُ
			12th word	11th word

	وَاسْتَغْفِرُهُ	رَبِّكَ	بِحَمْدِ	فَسَبِّحْ
	16th word	15th word	14th word	13th word
		تَوَابًا	كَانَ	إِنَّهُ
		19th word	18th word	17th word

### 19 Arabic words – Last revelation – Sura – 110 (19 + 91)

Furthermore, the first verse of Sura an-Nasr, which speaks of the help of Allah, contains 19 letters.

ا	1st letter	ص	8th letter	ا	15th letter
ذ	2nd letter	ر	9th letter	ل	16th letter
ا	3rd letter	ا	10th letter	ف	17th letter
ج	4th letter	ا	11th letter	ت	18th letter
ا	5th letter	ل	12th letter	ح	19th letter
ع	6th letter	ه	13th letter		
ن	7th letter	و	14th letter		

### 19 Arabic letters in the first verse of the last revelation – Sura - 110

18. The Quran mentions 30 different numbers:

1	7	19	70	1.000
2	8	20	80	2.000
3	9	30	99	3.000
4	10	40	100	5.000
5	11	50	200	50.000
6	12	60	300	100.000

The total of these numbers (again without taking repetitions into account) is **162,146**.

$$19 \times 8534 = 162,146$$

$1 + 2 + 3 + 4 + 5 + 6 + 7 + 8 + 9 + 10 + 11 + 12 + 19 + 20 + 30 + 40 + 50 + 60 + 70 + 80 + 99 + 100 + 200 + 300 + 1,000 + 2,000 + 3,000 + 5,000 + 50,000 + 100,000 = 162,146$  (19 x 8,534).

In addition to the thirty numbers in Quran, it also refers to **eight** fractions:

**1/10, 1/8, 1/6, 1/5, 1/4, 1/3, 1/2 and 2/3**

Also Number – 19 is the **8<sup>th</sup> Prime Number** in mathematics as: 2, 3, 5, 7, 11, 13, 17, **19**.....

Thus Quran contains a total of 30 numbers + **8** fractional numbers

**38 numbers = 19 x 2 = 38**

**19.** The Quran is the **19<sup>th</sup> and the Last Holy Scripture of Allah** (God).

The total number of scriptures is 19 and Quran besides being the Last Scripture is also the 19<sup>th</sup> Scripture delivered through the 20 Prophets mentioned in the Quran.

There are **total of 124,000 Messengers and Prophets in Islam** but **only 19 scriptures** had been delivered to 20 of the Prophets mentioned in Quran.

**'We have sent messengers before you, some of them we mentioned to you, and some We did not mention to you.'** (40:78 and 4:164)

If we read verses 83-86 of Sura 6, we read 18 names of Prophets starting with Abraham and ending with Prophet Lot. Verse 89 confirms that all these 18 were prophets of God:

**'These are the ones to whom we have given the Scripture, wisdom and prophet-hood.'** (Chapter - 6, Verse - 89)



*The Last Prophet of Allah – Prophet Muhammad (PBUH)*

**These Prophets (PBUH) are:**

- 1. Abraham (also named as a prophet in 19:41 and 33:7)**
- 2. Isaac (also in 19:49 and 37:112)**
- 3. Jacob (also in 19:49)**
- 4. Noah (also in 33: 7)**
- 5. David (also in 17:55)**
- 6. Solomon**
- 7. Job**
- 8. Joseph**
- 9. Moses (also in 19:51 and 33:7)**
- 10. Aaron (also in 19:53)**
- 11. Zachariah**
- 12. John (also in 3:39)**
- 13. Jesus (also in 19:30 and 33:7)**
- 14. Elias**
- 15. Ismail (also in 19:54)**
- 16. Elisha**
- 17. Jonah**
- 18. Lot**

The names of two other Prophets mentioned at other places in Quran are:

- 19. Idris (named a Prophet in 19:56)**
- 20. Muhammad (named and confirmed Last Prophet in 33:40)**

However we are told by Allah (God) that the two prophets Moses and Aaron who are also brothers received the same Scripture.

**The Statute book was given to both Moses and Aaron - [37:117 and 21:48]**

Therefore the total number of scriptures is 19 and Quran besides being the Last Scripture is also the **19th Scripture** delivered through the 20 Prophets mentioned in the Quran. There are total of 124,000 Messengers and Prophets in Islam but **only 19 scriptures** had been delivered to 20 of them.

**'We have sent messengers before you, some of them we mentioned to you, and some We did not mention to you.'** (40:78 and 4:164)



### Allah script outside Eski Cami (The Old Mosque) in Edirne, Turkey

20. The Quranic initial Arabic letters 'Alif', 'Lam' and 'Ra' appear in suras (chapters) - 10, 11, 12, 14 and 15 - total of 5 chapters. The total number of times these letters appear in these 5 suras (chapters) is as follows:

Sura (chapter) Number	Alif, Lam, Ra - 3 Arabic letters
1. Sura - 10	2489 = 19 x 131
2. Sura - 11	2489 = 19 x 131
3. Sura - 12	2375 = 19 x 125
4. Sura - 14	1197 = 19 x 63
5. Sura - 15	912 = 19 x 48

The total number of times , all these three (3) Arabic letters, 'Alif', 'Lam' and 'Ra' appear in the above Five (5) suras (chapters) is 9462 which is the multiple of 19 as shown below

Total (Alif, Lam, Ra ) in above Five (5) suras = 9462 = **19 x 498**

$$9462 = 19 \times 498$$

21. The sum of all the occurrences of the name of "Allah" (God) in all the verses (sentences) in Quran whose numbers are the multiples of 19. That is verses 19, 38, 57, 76 is 133 = 19 x 7.

$$133 = 19 \times 7$$

22. The 'Abjad' numerical value of Arabic word 'Al-Wahid' meaning One and Only Allah (God) is **19**. This word is also used with various other words in the Quran – 7 times such as 'one door', 'one variety of food'. But it is only used **19 times together with the name of 'Allah' (God)**.

The word “Wahid” is written with the letters ‘wau + alif + he + de’ the total mathematical values of these letters are (6 + 1 + 8 + 4) 19 as we have mentioned above.

$\begin{aligned} \text{Wav} + \text{Alif} + \text{Ha} + \text{Da} &= \text{total} \\ 6 + 1 + 8 + 4 &= 19 \end{aligned}$
---

The word “Wahid” whose mathematical value is 19, is used 19 times for God in the Quran. The list of these verses is given below in the table.

Serial number	1	2	3	4	5	6	7	8	9	10
Sura and Verse number	<b>2-163</b>	<b>4-171</b>	<b>5-73</b>	<b>6-19</b>	<b>12-39</b>	<b>13-16</b>	<b>14-48</b>	<b>14-52</b>	<b>16-22</b>	<b>16-51</b>
Serial number	11	12	13	14	15	16	17	18	19	
Sura and Verse number	<b>18-110</b>	<b>21-108</b>	<b>22-34</b>	<b>29-46</b>	<b>37-4</b>	<b>38-65</b>	<b>39-4</b>	<b>40-16</b>	<b>41-6</b>	

**23.** The total of the suras (chapters) and verse (sentence) numbers of the occasions when the word 'Wahid' appears 19 times is 361.

$$361 = 19 \times 19$$

**24.** We have seen that the words “Name + God + Gracious + Merciful” forming “Bismillahirrahmanirrahim” are coded with 19. These words are used throughout the Quran. In some verses “God” is used more than once and in some verses both “God” and “Merciful” are used equally. **Katerina Kullman, a Swedish lady**, was curious about how many verses have at least one of these 4 words and she was the first person who witnessed this interesting characteristic. If you write two 19s respectively, you get the number 19 and this number is the number of the verses which has at least one of the 4 words that form Basmalah.

The number of verses where at least one of the 4 words Of Basmalah is used	1919 (19 x 101)
--	-----------------

We counted the words in the numbered verses and found out that the words forming the Basmalah were the multipliers of 19. It is clear that the Basmalah is the first verse of sura “The Prologue” which is the first sura. Many people probably have not understood why the Basmalah is numbered only in the sura “The prologue” all through the Quran. And some people have thought that the Basmalah which is at the beginning of the sura “The Prologue” was numbered by mistake or other Basmalahs were placed at the beginning of other suras to imitate the sura

“The Prologue”. The code 19 solves problems and here it shows itself and how it eliminates all the suspicion.

**Does God not say in the 31st verse of the sura “The Hidden” that 19 will dispel the suspicions?**

While the words forming the Basmalah are counted within the numbered verses in the Quran, the enumeration of the letters in the suras starting with initial letters includes only that sura and its Basmalah. If we add the words “Bism + God+ Gracious+ Merciful” in these suras according to the method of the suras which have initial letters, we come up with the multiple of 19.

The total of the words in the suras that start with the initial letters (numbered verses + unnumbered Basmalahs)				
Name	God	Gracious	Merciful	Total
31	1121	66	74	1292 (19 x 68)

The result is 1292 (19×68). Besides the code 19, the number 68 is also important for this product since this case includes 29 suras that start with initial letters. The last of these 29 suras is **the sura “Pen” which is the 68th sura**. The total of the occurrence of those 4 words the first sura with initial letters (the 2nd sura) and the last one (the 68th sura) is 1292 (19x68)

$$1292 = 19 \times 68$$

**25.** The number of verses (sentences) between the first Quranic initial letters (Alif, Lam, Mim- Chapter 2- Al- Baqara) and the final initial letters (Nun- Chapter - 68 -Al-Qalam) is 5263

$$5263 = 19 \times 277$$

**26.** The Arabic word 'Rehman' meaning ‘the most Gracious’ appears 57 times in the Quran.

$$57 = 19 \times 3$$

**27.** The Arabic letters 'Ya' and 'Sin' appears at the beginning of sura (chapter) 'Ya Sin'. The letter 'Sin' appears 48 times in sura 'Ya Sin' and the letter 'Ya' appears 237 times. The total of these letters is 285 which is a multiple of 19.

$$285 = 19 \times 15$$

**28.** The 'Abjad' numerical value of Arabic word 'Al-Jami'u' meaning the Gatherer or collector is 114.

$$114 = 19 \times 6$$

**29.** There are 38 suras (chapters) - [ $19 \times 2 = 38$ ] without Quranic initial letters (like Alif, Lam, Mim, Nun, Qaf, etc) between the first sura which has initial letters and the last to have them.

$$38 = 19 \times 2$$

**30.** The Arabic letters 'Alif', 'Lam' and 'Mim' are the most frequently used letters in Arabic. They appear together at the beginning of Six (6) suras (chapters), for example in Suras 2, 3, 29, 30, 31, and 32. The number of times these three (3) letters appear in each of these six (6) suras is a multiple of 19.

In order to understand, let us see the following illustration:

<b>Sura (chapter) Number</b>	<b>Alif, Lam, Mim - 3 Arabic letters</b>
1. Sura - 2	$9899 = 19 \times 521$
2. Sura - 3	$5662 = 19 \times 298$
3. Sura - 29	$1672 = 19 \times 88$
4. Sura - 30	$1254 = 19 \times 66$
5. Sura - 31	$817 = 19 \times 43$
6. Sura - 32	$570 = 19 \times 30$

The total number of times, all these three (3) Arabic letters appear in the above Six (6) suras (chapters) is 19,874 which is also the multiple of 19 as shown below.

Total (Alif, Lam, Mim) in above Six (6) suras = 19,874 =  $19 \times 1046$

$$19874 = 19 \times 1046$$

**31.** The 96th sura (chapter) consists of 19 verses (sentences) and contains a total of 285 letters -  $285 = 19 \times 15$ .

$$285 = 19 \times 15$$

**32.** The sura (chapter) from the beginning to possess 19 verses (sentences) is sura '**Al- Infitar**'.

### **19 Verses**

**33.** The sura (chapter) **50th** which begins with the letter 'Qaf' contains a total of **57 letters 'Qaf'**

The number of "Qaf's used in the sura
57 (19x3)



**34. The Sura (chapter) 42nd contains 57 letters of 'Qaf'.**

The number of "Qaf's used in the sura
57 (19x3)

**35. The Sura (chapter) 50th contains 45 verses (sentences). Adding sura number and the verses in this sura:**

$$50\text{- sura no} + 45\text{ - verses no} = 95 \qquad 95 = 19 \times 5$$

The total of the verses and sura numbers which have "Qaf" as initial letter		
Number of the sura	Number of the verses	Total
50	45	95 (19x5)
42	53	95 (19x5)

The Sura (chapter) 42nd contains 53 verses (sentences). Adding sura number and the verses in this sura:

50th Sura		57 (19x3) Letter Qaf
42nd Sura		57 (19x3) Letter Qaf
50th Sura	45th verse	50+45=95 (19x5)
42nd Sura	53rd verse	42+53=95 (19x5)

**36. The sura "Mary" is the 19th sura** and is introduced with the initial letters "Qaf, He, Ya, Ayn, Sad". This sura, whose sura number is important, has the longest form of the initial letters in one verse.

These **5 letters** are used **798 (19 × 42) times throughout the sura Mary.**

The total of the initial letters throughout the sura Mary					
Qaf	He	Ya	Ayn	Sad	total
137	175	343	117	26	798 (19x42)

Additionally, in the sura 19 if we put the mathematical value of "Qaf, He, Ya, Ayn, Sad" next to each other we get

$$20\ 5\ 10\ 70\ 90 = 19 \times 10795110$$

37. There are 10 Suras in the Holy Quran in which if we place the Sura Numbers and the Number of Verses in those Suras side by side and then divide by Number – 19, the numbers would be completely divided by 19:

So there are only 10 Suras, which show this special property and Number – 19 is the 10<sup>th</sup> Odd Number in Mathematics.

**Odd Numbers: 1, 3, 5, 7, 9, 11, 13, 15, 17, 19.....**

### **19 ----- 10<sup>th</sup> Odd Number in Mathematics**

- **Sura – 27 and Verses in Sura – 27 are – 93**

$$27 - 93 = 2793 \text{ divided by } 19 = 147$$

$$19 \times 147 = 2793$$

- **Sura – 28 and Verses in Sura – 28 are – 88**

$$28 - 88 = 2388 \text{ divided by } 19 = 152$$

$$19 \times 152 = 2388$$

- **Sura – 32 and Verses in Sura 32 are – 30**

$$32 - 88 = 3288 \text{ divided by } 19 = 170$$

$$19 \times 170 = 3288$$

- **Sura – 40 and Verses in Sura – 40 are – 85**

$$40 - 85 = 4085 \text{ divided by } 19 = 215$$

$$19 \times 215 = 4085$$

- **Sura – 43 and Verses in Sura 43 are – 89**

$$43 - 89 = 4389 \text{ divided by } 19 = 231$$

$$19 \times 231 = 4389$$

- **Sura – 66 and Verses in Sura 66 are – 12**

$$66 - 12 = 6612 \text{ divided by } 19 = 348$$

$$19 \times 348 = 6612$$

- Sura – 89 and Verses in Sura 89 are – 30

$$89 - 30 = 8930 \text{ divided by } 19 = 470$$

$$19 \times 470 = 8930$$

- Sura – 98 and Verses in Sura 98 are – 8

$$98 - 8 = 998 \text{ divided by } 19 = 52$$

$$19 \times 52 = 998$$

- Sura – 106 and Verses in Sura 106 are – 4

$$106 - 4 = 1064 \text{ divided by } 19 = 56$$

$$19 \times 56 = 1064$$

- Sura – 108 and Verses in Sura 108 are – 3

$$108 - 3 = 1083 \text{ divided by } 19 = 57$$

$$19 \times 57 = 1083$$

**38.** We all know that the order of the Suras of the Quran is different from the order of revelation. It gives us another fact that the Holy Quran is a mathematical miracle. It confirms beyond doubt that the collection and the writing of the Quran was all controlled by God Almighty, the author of the Quran Himself.

Let us write down the numbers of all the Suras of the Quran preceded by their revelation order next to each other. **Sura 1 is the 5<sup>th</sup> Sura revealed**, thus the number representing it looks like this: 5 **1**. Sura 2 is the 87<sup>th</sup> Sura revealed its number looks like this: 87 **2**. The number representing the first two Suras looks like this: 5 **1** 87 **2**.

Let us do the same with all the Suras. We get a final number that consists of **468 digits** and that long number follows the same pattern of the rest of the Mathematical Miracle of the Quran, is a multiple of 19.

Here is the final number representing the Sura numbers preceded by their revelation order:

51872893924112555639788811395110521153129613721454157016501769184419  
 452073211032274231022442254726482749288529843057317532903358344335  
 413656373838593960406141624263436444654566469547111481064934506751  
 7652235337549755465694571055810159916010961110621046310864996510766  
 77672687869797071714072373474317598763377807881792480781828286838384  
 27853686887688810893590269199211931294289519625971009893991410030101  
 16102131033210419105291061710715108181091141106111221122011321114

*The above number divided by the number 19 gives us this 468 digits Number:*

27301523117953976652520427050058169027962954590239030008685141676010  
 23793326896435485843286434459288565752027886476700922784387281280811  
 24507230729441896874429601386507603445086681826902531920707930272448  
 54491449987129773398476621587364000576900559002437413947184777198775  
 09887884056406003809130227242040177779362199604251675172991493909396  
 67730930990047031066799958522699699448401366895257578495264742166369  
 54264905811531857424300563953062162691637163748480105859006

*(Reference: <http://www.submission.org/miracle/order.html>)*

39. There are 30 Paras (Parts) of the Holy Quran and Number – 30 is the 19<sup>th</sup> Composite Number in Mathematics.



30 Paras (Parts) of the Holy Quran.

Composite Numbers..... 4, 6, 8, 9, 10, 12, 14, 15, 16, 18, 20, 21, 22, 24, 25, 26, 27, 28, 30....

Number 30.....19<sup>th</sup> Composite Number

- 3019 is the Prime Number

**Prime Number ----3019-----30 is the 19<sup>th</sup> Composite Number in Mathematics**

**40.** The Arabic word ‘Rasul’ meaning the Messenger of Allah comes 513 times in the Holy Quran

**Arabic word ‘Rasul’ comes 513 times in the Holy Quran.**

$$19 \times 27 = 513$$

**41.** The Arabic word ‘Salat’ meaning Prayer is mentioned 67 times in the Holy Quran and Number 67 is the 19th Prime Number in Mathematics.

**Salat – 67 times in the Holy Quran**

**Prime Numbers..... 2, 3, 5, 7, 11, 13, 17, 19, 23, 29, 31, 37, 41, 43, 47, 53, 59, 61, 67.....**

**Number – 67.....19<sup>th</sup> Prime Number in Mathematics**

- Number – 6719 is a Prime Number in Mathematics

**Prime Number – 6719 .....67 is the 19<sup>th</sup> Prime Number in Mathematics**

**42.** The Arabic word ‘Atee’ meaning to obey appears 19 times in the Holy Quran

Arabic word “Atee” --- 19 times in the Holy Quran

$$19 \times 1 = 19$$

**43.** The Arabic words, ‘Abd’ meaning servant, ‘Aabid’ meaning a person who serves and ‘Abudu’ meaning worship appear a total of 152 times in the Holy Quran.

Arabic Words ---“Abd, Aabid, and Abudu” ---- 152 times in the Holy Quran

$$19 \times 8 = 152$$

**44.** The Arabic word ‘Munafiqeen’ meaning “hypocrite” appears 19 times in the Holy Quran

**Arabic Word “Munafiqeen” --- 19 times in the Holy Quran**

$$19 \times 1 = 19$$

45. The name of Allah 'Al – Sabur' meaning 'the Patient' appearing in Surahs 2:253, 3:200, 103:3 and the Abjad – Numerical value of 'Al – Sabur' is 298.

**Abjad – Numerical Value of the Arabic name of God 'Al – Sabur' = 298**

**Adding the Numbers of 298, we would get:**

$$298 \dots\dots\dots 2 + 9 + 8 = 19$$

$$19 \times 1 = 19$$

46. There are only 2 Suras in the Holy Quran whose names starts with only 1 Arabic letter, one is Sura – 38 known as Sura 'Sawad' and the other sura – 50 known as Sura 'Qaf'.

**The Abjad – Numerical value of 'Qaf' is 100 and the value of 'Sawad' is 90.**

**If we add the numerical values of both the letters – 'Sawad + Qaf' = 90 + 100 = 190**

$$19 \times 10 = 190$$

Interestingly, if we add the numbers 1 to 19, the sum also comes to 190

$$1 + 2 + 3 + \dots\dots\dots + 18 + 19 = 190 = 19 \times 10$$

47. The 73rd Sura (chapter) contains 57 words.

$$57 \text{ words of 73rd chapter} = 19 \times 3$$

48. The Arabic word 'Wahdahu', meaning "worship only Allah", appears in the verses 7:70, 39:45, 40:12, 40:84 and 60:4. When the Sura Numbers and the Verse Numbers are added up without Sura numbers being repeated, the total is 361.

(7: 70) + (39: 45) + Sura 40 has two verses – 12 and 84. So we add the Sura Number – 40 only one time + (60:4)

$$(7 + 70) + (39 + 45) + (40 + 12 + 84) + (60 + 4) = 361$$

$$19 \times 19 = 361$$

49. The Arabic word 'Kul – e – Shai' meaning 'Everything' appear 114 times in the Quran.

**Kul – e – Shai = Every Thing = 114 times in the Holy Quran**

$$19 \times 6 = 114$$

50. The 'Abjad' – numerical value of Arabic word 'Kul – e – Shai' is 361.

**Numerical Value of 'Kul – e – Shai' meaning Everything = 361**

$$19 \times 19 = 361$$

51. The important phrase in Islam, 'Wahdahoo La Sharika Lah', meaning 'God is Alone, HE has no partners' has a gematrical or numerical value of 619 and 619 is the 114th prime number in order.

**619 is the 114<sup>th</sup> Prime Number in mathematics**

$$19 \times 6 = 114$$

52. The first 'Kalim' in Islam is, 'La Ilah Ila Allah, Muhammad ur Rasul Allah', meaning 'There is no God, except Allah, Muhammad is the Prophet of Allah' has again a gematrical or numerical value of 619 and 619 is the 114th prime number in order.

**619 is the 114<sup>th</sup> Prime Number in mathematics**

$$19 \times 6 = 114$$

53. The Number of Verse and Sura together in Qur'an which describes Jesus Christ Birth (Qur'an 19:19).

**Sura – 19, Verse -1 9**

Writing both the numbers side by side, we would get the number - 1919:

$$19 \times 101 = 1919$$

54. The Abjad or Numerical value of the Arabic word 'Quran' is 351.

**The Numerical value of the Arabic word 'Quran' is 351.**

**19 in mathematics:**

- 19----- 19<sup>th</sup> Natural Number (1, 2....., 18,19)
- 18----- 19<sup>th</sup> Integer (0, 1, 2,....., 17, 18)
- 36 ----- 19<sup>th</sup> Even Number (0, 2, 4, 6, 8,....., 34, 36)
- 37 ----- 19<sup>th</sup> Odd Number (1, 3, 5,....., 35, 37)
- 67 ----- 19<sup>th</sup> Prime Number (2, 3, 5,....., 61, 67)
- 30 ----- 19<sup>th</sup> Composite Number (4, 6, 8,....., 28, 30)
- 144 ----- 19<sup>th</sup> Powerful Number (1, 4, 8, ....., 128, 144)

If we add all the numbers associated with Number – 19 in the above table, their sum comes to 351.

$$19 + 18 + 36 + 37 + 67 + 30 + 144 = 351$$

**351 = Numerical value of the Arabic word ‘Quran’**

55. God has ordered 5 prayers for the Muslims in the Holy Quran. The rakats in each prayer are:

- Fajar Prayers            2
- Zuhar Prayers         4
- Asr Prayers             4
- Maghrib Prayers      3
- Isha Prayers            4

If we write the sequence of the 5 prayers in One number as: 24434

**In mathematics, the Number – 280009 is the 24434<sup>th</sup> Prime Number**

If we add the numbers of the Prime Number – 280009, we would get the Number – 19 as:

$$280009..... 2 + 8 + 0 + 0 + 0 + 9 = 19$$

Also, if we add the numbers as:

$$280009.....28 + 00 + 09 = 37$$

Number – 37 is the 19<sup>th</sup> Odd Number in Mathematics

$$37.....19^{\text{th}} \text{ Odd number}$$

$$3719.....\text{Prime Number in Mathematics}$$

56. There are 3 Suras (Chapters) in the Holy Quran, whose verses are 19:

- Sura 82                    19 Verses
- Sura 87                    19 Verses
- Sura 96                    19 Verses

57. There are 114 Suras of the Holy Quran in total.

$$19 \times 6 = 114 = 38 + 38 + 38$$



- There are 38 Suras of the Holy Quran, which are divisible by Number - 2.

For example, Suras (2, 4, 6, 8, 10, 12,..... 112, 114) and

$$19 \times 2 = 38 \text{ Suras}$$

The sum of these Sura Numbers are 2166 and the Number – 2166 is:

$$19 \times 114 = 2166$$

- Similarly, there are 38 Suras (Chapters), which are divisible by Number – 3.

For example, Suras (3, 6, 9, 12, .....108, 111, 114)

The sum of these Sura Numbers are 2223 and the Number – 2223 is:

$$19 \times 117$$

- And there are 38 Suras (Chapters), which are neither divisible by Number – 2 nor by Number - 3.

For example, Suras (1, 5, 7,.....107, 109, 113)

The sum of these Sura Numbers are 2166 and the Number – 2166 is:

$$19 \times 114$$

The total of these Suras Numbers are:  $2166 + 2223 + 2166 = 6555$

$$19 \times 345 = 6555$$

**58.** The last Sura of the Holy Quran is 114<sup>th</sup> Sura – Sura – An – Nas.

The title of 114<sup>th</sup> Sura - An-nas means ‘Mankind’. The gematrical value of this Arabic word is 142. This sura has 6 verses which consists of 20 words and 80 letters and this last Sura has a gematrical total of 4901.

Adding all the numbers of this Sura, we see:

$$114 + 142 + 6 + 20 + 80 + 4901 = 5263$$

$$19 \times 277 = 5263$$

The numerical value of the word "Annas" is 142. Let us reverse this number: we have then 241, and this is the total of the word "Annas" (Mankind) in the whole Quran. Also the reciprocal of the Number – 19 is:

$$1/19 = 0.052631579..... \quad \& \quad 19 \times 277 = 5263$$

**60. The sum of all the total verses embedded between the first initial sura 2 and the last sura 68 is 5263.**

$$19 \times 277 = 5263$$

**61.** There are 114 Suras and 30 paras of the Holy Quran. In mathematics, there are 30 prime numbers below the Number – 114.

### **30 Prime Numbers below the Number – 114**

### **30 is the 19<sup>th</sup> Composite Number in Mathematics**

**62.** The Kalima of all the Muslims of the world is “لا إله إلا الله”. The first two words of the Kalima are : لا إله meaning ‘There is No God’.

The Abjad or numerical value of these first two words of the Kalima is 67.

### **Number – 67 is the 19<sup>th</sup> Prime Number in Mathematics**

**The Abjad or Numerical value of “لا إله” = 67 .....19<sup>th</sup> Prime Number**

**63.** There are 10 Suras in the Holy Quran, where the sum of the Sura Number and the total number of Verses in that Sura is divisible by Number – 19 as:

1. Sura – 41 + Verses – 54 = 95 = 19 x 5
2. Sura – 42 + Verses – 53 = 95 = 19 x 5
3. Sura – 70 + Verses – 44 = 114 = 19 x 6
4. Sura – 88 + Verses – 26 = 114 = 19 x 6
5. Sura – 15 + Verses – 99 = 114 = 19 x 6
6. Sura – 39 + Verses – 75 = 114 = 19 x 6
7. Sura – 107 + Verses – 7 = 114 = 19 x 6
8. Sura – 21 + Verses – 112 = 133 = 19 x 7
9. Sura – 55 + Verses – 78 = 133 = 19 x 7
10. Sura – 6 + Verses – 165 = 171 = 19 x 9

The sum of the above 10 Sura Numbers comes to 484 and the sum of their Verses comes to 713

$$484 + 713 = 1197 = 19 \times 63$$

- 63 is the Age, when Prophet Muhammad departed from this world to His Allah. The reverse of the number – 63 is 36. Adding both numbers, we see:

$$63 + 36 = 99 \dots \dots \dots \text{Names of Allah in the Holy Quran}$$

64. There are 30 paras (parts) of the Holy Quran. The 30<sup>th</sup> Para of the Holy Quran contains 37 Suras and the Number – 37 is the 19<sup>th</sup> Odd Number.

$$30^{\text{th}} \text{ Para of the Holy Quran} \text{-----} 37 \text{ Suras}$$

$$37 \dots \dots \dots 19^{\text{th}} \text{ Odd Number}$$

65. The 21<sup>st</sup> Arabic letter ‘Qaf’ is mentioned 6823 times in the Holy Quran. The Arabic name of the Holy Book ‘Quran’ also starts with this Arabic letter of – ‘Qaf’.

$$21^{\text{st}} \text{ Arabic Letter} \text{-----} \text{‘Qaf’} \text{—} 6823 \text{ times in the Holy Quran}$$

$$6823 \text{ ‘Qaf’ in the Holy Quran} \dots \dots \dots 6 + 8 + 2 + 3 = 19$$

$$6823 \dots \dots \dots 19$$

The reverse number of Number – 19 is 91. If we add the numbers of 6823 as:

$$6823 \dots \dots \dots 68 + 23 = 91 \dots \dots \dots \text{The reverse number of Number - 19}$$

The Abjad – numeric value of this letter ‘Qaf’ is 100. Now if we multiply the number – 6823 with the Abjad – numeric value of the letter ‘Qaf’, we would get:

$$6823 \times 100 = 682,300$$

The sum of all the numbers in 682,300 is also 19:

$$682,300 \dots \dots \dots 6 + 8 + 2 + 3 + 0 + 0 = 19$$

66. There are 30 whole numbers mentioned in the Holy Quran. Out of 30 whole numbers there are only 6 prime numbers and the Number – 19 is the highest prime number mentioned in the Holy Quran as:

$$2, 3, 5, 7, 11, \text{ and } 19$$

$$19 \dots \dots \dots \text{Highest Prime Number mentioned in the Holy Quran}$$

The sum of the other 5 prime numbers mentioned in the Holy Quran is:

$$2 + 3 + 5 + 7 + 11 = 28 \dots\dots\dots 28 \text{ Arabic letters in the Arabic language}$$

67. Allah’s name ‘Raheem’ meaning ‘The most Merciful’ appears 114 times in the Holy Quran.

$$\text{Raheem} \text{-----} 114 \text{ Times in the Holy Quran}$$
$$114 \dots\dots\dots 19 \times 6$$

68. The Abjad – numeric value of the 6<sup>th</sup> Arabic letter ‘Ha’ is 8. Number – 19 is also the 8<sup>th</sup> Prime Number. This letter ‘Ha’ appears – 9997 times in the Holy Quran.

$$\text{Arabic letter ‘Ha’} \text{-----} 9997 \text{ times in the Holy Quran}$$

If we multiply the number – 9997 with the Abjad value of the letter ‘Ha’, we would get:

$$9997 \times 8 = 79976$$

The sum of all the numbers in 79976 is:

$$79976 \dots\dots\dots 7 + 9 + 9 + 7 + 6 = 38$$

$$19 \times 2 = 38$$

69. The Abjad – numeric value of the 14<sup>th</sup> Arabic letter ‘Sad’ is 90. This letter ‘Sad’ appears – 1274 times in the Holy Quran.

$$\text{Arabic letter ‘Sad’} \text{-----} 1274 \text{ times in the Holy Quran}$$

The sum of all the numbers in 1274 is also 14, which is the Abjad value of this Arabic letter:

$$1274 \dots\dots\dots 1 + 2 + 7 + 4 = 14 \dots\dots \text{Abjad Value of ‘Sad’}$$

And if we multiply the number – 1274 with the Abjad value of the letter ‘Sad’, we would get an amazing number:

$$1274 \times 14 = 114, 660$$

In this number - 114,660.....114 represents the total number of Suras (Chapters) in the Holy Quran (19 x 6 = 114) and the Number – 66 represents the Abjad – numeric value of the name of God – “Allah” which is also 66.

$$114 \dots\dots\dots \text{Total Number of Suras (Chapters)}$$

**66.....Abjad – Numeric value of the name of God ‘Allah’**

Then if we add all the numbers in 114,660, we would get:

$$114,660..... 1 + 1 + 4 + 6 + 6 + 0 = 9$$

The Abjad value of the Arabic letter –‘Sad’ is 90. If we add the numbers in 90, we would get:

$$90.....9 + 0 = 9$$

70. In his book 'The Numerical Miracle of the Qur'an', the *Syrian writer Sidqi Al-Beik* counted the number of integers in the Holy Qur'an and found them to be **285**. The following table shows his findings:

<b>Integer</b>	<b>1</b>	<b>2</b>	<b>3</b>	<b>4</b>	<b>5</b>	<b>6</b>	<b>7</b>	<b>8</b>
<b>Frequency</b>	<b>145</b>	<b>15</b>	<b>17</b>	<b>12</b>	<b>2</b>	<b>7</b>	<b>24</b>	<b>5</b>
<b>Integer</b>	<b>9</b>	<b>10</b>	<b>11</b>	<b>12</b>	<b>19</b>	<b>20</b>	<b>30</b>	<b>40</b>
<b>Frequency</b>	<b>4</b>	<b>9</b>	<b>1</b>	<b>5</b>	<b>1</b>	<b>1</b>	<b>2</b>	<b>4</b>
<b>Integer</b>	<b>50</b>	<b>60</b>	<b>70</b>	<b>80</b>	<b>99</b>	<b>100</b>	<b>200</b>	<b>300</b>
<b>Frequency</b>	<b>1</b>	<b>1</b>	<b>3</b>	<b>1</b>	<b>1</b>	<b>6</b>	<b>2</b>	<b>1</b>
<b>Integer</b>	<b>309</b>	<b>950</b>	<b>1000</b>	<b>2000</b>	<b>3000</b>	<b>5000</b>	<b>50000</b>	<b>100000</b>
<b>Frequency</b>	<b>1</b>	<b>1</b>	<b>8</b>	<b>1</b>	<b>1</b>	<b>1</b>	<b>1</b>	<b>1</b>

$$285 = 19 \times 15$$

71. Sura 72 has 285 words in 28 verses.

$$285 \text{ words of Sura} - 72 = 19 \times 15 = 285$$

72. We look now for the occurrence and gematria of the letters in Sura – 19 (Sura Mariam) composing the word 'Nineteen' which is mentioned in the sura – 74, Verse – 30

<b>basmallah included</b>	<b>ر</b>	<b>ش</b>	<b>ع</b>	<b>ة</b>	<b>ع</b>	<b>س</b>	<b>ت</b>	<b>letters of NINETEEN</b>
<b>letters</b>	<b>169</b>	<b>35</b>	<b>117</b>	<b>175</b>	<b>117</b>	<b>66</b>	<b>143</b>	<b>822</b>
<b>gematria</b>	<b>34200</b>	<b>10500</b>	<b>8190</b>	<b>875</b>	<b>8190</b>	<b>3960</b>	<b>57200</b>	<b>123115</b>
							<b>Total</b>	<b>123937</b>
								<b>19 x 6523</b>

73. The sura 19 begins with 5 initials: K.H.Y.A'.S

The total of these letters in the whole Sura 19 including the Basmalah is 798 letters which is 19 x 42.

$$798 = 19 \times 42$$

74. The title of sura 19 is ' Mariam' and is composed with the letters M, R, Y ( م - ر - ي )

Gematria Mary = م - ر - ي		
م	ر	ي
11600	33800	3430
48830 = 19 x 2570		

75. The Gematria of the Arabic letters of the Arabic word 'Isa' meaning 'Jesus' in the Sura – 19 are the multiples of 19 as:

Gematria Jesus		
س	ي	ع
3960	3430	8190
15580 = 19 x 820		

76. The 'Abjad' - numeric value of the Arabic word 'Rehman', meaning 'the most Gracious' is 298. The sum of the numbers of 2, 9 and 8 is:

**Rehman -----298..... 2 + 9 + 8 = 19**

The numerical value of the word "Rehman"				
Ra	He	Mem	Noon	total
200	8	40	50	298

## Even and Odd Suras of the Holy Quran and 19

---

*“By the even and the odd”  
(Sura – 89, Verse – 3, Holy Quran)*

The 3rd verse of the 89th sura in the Quran draws out attention to the “even” and “odd” numbers of the suras of the Holy Quran.

When we add sura (chapter) number and the verses (sentences) in the corresponding sura, we would see that 57 suras (chapters) are even numbers and 57 suras (chapters).

$$57 \text{ Even Suras} = 19 \times 3$$

$$57 \text{ Odd Suras} = 19 \times 3$$

$$57 \text{ Odd Suras} + 57 \text{ Even Suras} = 114 \text{ total Suras}$$

$$114 \text{ total Suras} = 19 \times 6$$

The verse numbers and sura numbers in Quran, is indicated in figures, such as the sura Prologue 1:7 (the 1st sura and 7 verses) and the sura Cow 2:286 (the 2nd sura and the 286 verses). On the table below, add 1 and 7 (the sura number and the number of the verses of the sura Prologue) and we get number “8”. Since the number “8” is an even number, write it on the place reserved for even numbers.

And we add 3 and 200 (the sura number and the number of the verses of the sura the Family of Imran), then we get number “203”. As this number is an odd number we will write it on the place where odd numbers are. We do the same operation for all other suras and verses of the Quran. Please follow it on the table below. We think that this table alone is enough to show that the Quran’s sura rows and verse numbers are protected and the Quran has a miraculous mathematical structure.

Sura number	Total of verses	Total	Even	Odd
1	7	8	8	-
2	286	288	288	-
3	200	203	-	203
4	176	180	180	-
5	120	125	-	125
6	165	171	-	171
.....				

	57	29	86		
.....					
	109	6	115	-	115
	110	3	113	-	113
	111	5	116	116	-
	112	4	116	116	-
	113	5	118	118	-
	114	6	120	120	-
total	<b>6555</b>	<b>6234</b>	-	<b>6234</b>	<b>6555</b>

The total number of suras in the Quran is **6555**; the total of the **odd numbers** in the table is also 6555. These two numbers are equal, although independent from each other. Moreover, the total of the number of verses in the Quran is 6234 (excluding 'Basmalah' in the beginning of each sura, which are 112 in total in the beginning) and the total of the **even numbers** on the table is 6234. They do not have to be equal but they are. The equality of these numbers is one of the countless proofs that all the sura numbers and the number of the verses of the Quran are arranged heavenly.

$$114 \text{ Suras in Quran} = 19 \times 6 = 6 \times (10 + 9) = 60 + 54$$

We know that the number of the suras in the Quran is 114 (19×6). If we write 19 in the form of 10+9, we have **6 × (10+9)**. From this equation we obtain 60 and this number represents the number of suras whose total verses are even numbers. From this equation we also obtain 54 which is the number of the suras whose total verses consist of odd numbers.

The **sura numbers of 30 of these 60 suras are odd numbers** and the sura numbers of the other **30 of these 60 suras are even numbers**. The sura numbers of **27 of the 54 suras are odd numbers** and the sura numbers of **27 of these 54 suras are even numbers**. And their frequency may be given as follows:

$$30 + 27 = 3 \times (10+9) \dots \dots \dots \text{Even and Odd sura numbers.}$$

**We get 30 and 27.**

$$114 = 6 \times 19 = 6 \times (10+9) = (6 \times 10) + (6 \times 9) = 60+54$$

$$57 = 3 \times 19 = 3 \times (10 + 9) = (3 \times 10) + (3 \times 9) = 30 + 27$$

Now we have four groups each. Let us give an example for each group:



1. Suras with odd numbers- the number of verses with odd numbers. Example: the sura

**Prologue (1st sura, 7 verses)**

2. Suras with even numbers- the number of verses with even numbers. Example:

**The Family of Imran (3rd sura, 200 verses)**

3. Suras with even numbers- the number of verses with odd numbers. Example:

**The Cattle (6th sura, 165 verses)**

4. Suras with even numbers- the number of verses with even numbers. Example:

**The Women (4th sura, 176 verses)**

**We see the table which contains of the 4 groups:**

114 SURAS			
THE SURAS WITH EVEN NUMBERED VERSES:60		THE SURAS WITH ODD NUMBERED VERSES:54	
EVEN NUMBERED SURAS:30	ODD NUMBERED SURAS:30	EVEN NUMBERED SURAS:27	ODD NUMBERED SURAS:27

If you change the place of a single verse in a sura, the system would change. For instance, if the sura Prologue was consisted of 8 verses, the system would change and if the sura Family of Imran was the 2nd sura (it is the 3rd sura of the Quran) this mathematical system would change again.

Only if we added 2 or 4 verses (even numbers) to a sura or subtracted 2 or 4 verses from a sura, the numbers on the table above would not change. However, if we added any number to both suras whose total verses are even and suras whose total verses are odd, all the data on the table would change. If we changed the places of a sura whose sura number is an even number and a sura whose sura number is an odd number, all the data would change and the system would be upset once again. To insist that the origin of such a table is by a coincidence, may be due to the ignorance of the probability assumptions or a result of pure stubbornness. God draws our attention that He has numerically structured the books (83rd sura, 9th and 20th verses). He also refers to the “even” and “odd” numbers. These tables we examine will help us to perceive the wisdom of God.

## Homogeneous and Heterogeneous Suras and 19

We can examine the suras in two groups: **1. Homogeneous Suras** and **2. Heterogeneous suras**. The homogeneous suras consist of the suras whose sura order number and total verse number both are odd or both are even. The heterogeneous suras consist of the suras whose sura order number is even when the total verse number is odd or vice versa. There are 57 homogeneous and 57 heterogeneous suras. One can understand this better by following the table:

114 SURAS			
HOMOGENOUS SURAS		HETEROGENEOUS SURAS	
57 SURAS		57 SURAS	
even sura number even total verses: 30 SURAS	odd sura number odd total verses: 27 SURAS	even sura number odd total verses: 30 SURAS	odd sura number even total verses: 27 SURAS

As the total of the sura numbers and verse numbers are meaningful in relation to their being even and odd, so, the number of the even and the odd suras and the number of the even and odd verses are meaningful as it can be seen in the symmetrical tables. We should add that there is more that and this proves the divine design as per even and odd.

We have seen that the total of the sura numbers in the Quran is 6555. This number is also equal to the total of the odd numbers on the table (When we add some of the sura numbers and the numbers of the verses, we get these odd numbers on the table). The total of the numbers in succession is counted with the help of the following formula as follows:  $n \times (n+1)/2$ . Thus, we can count the total of the sura numbers in the Quran like this:

$$114 \times (114+1)/2=6555$$

Jordanian researcher **Jalghoom** thought that there were 60 suras which had verses whose total number was an even number and 54 suras which had verses whose total number was an odd number. And then he divided this formula into two parts and wrote them as follows:

$$60 \times (114+1)/2=3450$$

$$54 \times (114+1)/2=3105$$

$$\text{Total}=6555$$

Here, we come across an interesting conclusion: the total of the sura numbers of the suras having verses whose total number is an even number is 3450 and the total of the sura numbers of the suras having verses whose total number is an odd number is 3105.

Let us explain the example we have given above in terms of its conclusion: Let us take the 3rd and 17th suras. The 3rd sura consists of 200 verses, it means that the 3rd sura is a sura having verses whose total number is an even number. The 17th sura consists of 111 verses, it means that the 17th sura is a sura having verses whose total number is an odd number. Let us think that the sura numbers of these suras are exchanged .In that case. If you added the sura numbers of the suras having verses whose total number is an even number, the result would be 3464.If you added the sura numbers of suras having verses whose total number is an odd number, it would give 3091.Thus, the data we have got in that equation would change.

It means that even if you change the order of two suras in the Quran, this mathematical table will have to change. And this shows the sura numbers of the Quran are arranged heavenly and this arrangement will not accept even a single change.

If we divide the Quran into two parts, the first part ends at the 57th sura, which is the sura Iron (Hadid). If we add the sura numbers of the first 57 suras, it gives 1653. If we multiply the sura number of the sura Iron (57) and the number of the verses in Iron sura (29), we have: **57×29=1653 (19×87)**. Thus, when we examine the Quran by dividing it into two parts, the sura Iron implies that we are going to have interesting mathematical data.

The total of the numbers of suras in the first half of the Quran (1+2+3+.....+55+56+57)	1653(19×87)
Multiplication result of the last sura’s number (57) in the first half of the Quran by the number (29) of verses in this sura	1653(19×87)

There are **29 odd numbered and 28 even numbered suras in the first part of the Quran.** There are **28 odd numbered and 29 even numbered suras in the second part of the Quran.** This is because of a mathematical property, because all numbers following one another shows this characteristic. However, it is interesting that while there are 29 “heterogeneous” and 28 “homogeneous” suras in the first part of the Quran, there are 28 “heterogeneous” and 29 “homogeneous” suras in the second part. This conclusion is the result of mathematical characteristics. This is one of the endless miracles of the Quran (Please remember the table about homogeneous and heterogeneous suras).

<b>114 SURAS</b>			
First half of the Quran:57		Second half of the Quran:57	
29 odd numbered suras	28 even numbered suras	29 even numbered suras	28odd numbered suras
29 homogenous sura	28 heterogeneous suras	29heterogenous suras	28homegenous sura

Even the examination of the sura numbers and the number of the verses in the Quran as “odd” and ”even” is enough to prove that the row of suras and the number of verses in the Quran are arranged heavenly and the mathematical system protects this structure. We have only one book having mathematical miracles and this Holy Book shows endless miracles it is beyond human power and was revealed by The Creator.

**“If all the humans and the jinns came together in order to produce a The Quran like this, they would surely fail, no matter how much assistance they lent one another.”**  
(Sura - 17, Verse – 88 – Holy Quran)

## **Encrypted Communication – Even and Odd Arrangement:**

Here we see one of the most surprising demonstrations of mathematical relationships between chapter and total verse numbers. It is the most modern method of an error check bit in computer data transmission.

*Thomas H. Athey and Robert W. Zmud* write in their book 'Introduction to Computers and Information Systems (Illinois: Scott, Foresmann and Company, 1986, pp. 238-39):

"To send data in a telecommunications network, start and stop information, origin and destination, information and error check bits must be added to the encoded data to form a data packet. The error check bit is used to make sure the data received were not garbled during transmission. In asynchronous transmission, the commonly used error check method is a parity bit. A parity bit is an extra bit that makes the sum of bits representing a character *either even or odd.*"

Now Quran, the Last Word and the Last Holy Book of Islam shows that a system is built in it 1400 years ago before the invention of computers and computer data transmission that its chapters and corresponding total verses in that chapter were transmitted without error and that the Quran is of Divine origin.

**57 of the results (Chapter numbers + Verses Numbers) are odd and 57 of the results are even out of the total of 114 Chapters in Quran.**

In this age of science and computers, when many want to be justified only by science and mathematics, it is a solid and mathematical proof that we have a mathematical encoded message from our One and Only God - Allah i.e. Quran- The Last Word and Holy Book of Islam.

## Basmalah and 19



When we examine the number of repetitions and the numerical values of the names of God according to the code 19, we come across with a magnificent table. **Dr. Cesar Mejul, former rector of the Philippine Islands Islamic Research University**, is the first person who discovered this table. We can describe this extraordinary mathematical relation briefly as follows:

- 1) The repetition of only the 4 names of God is a multiple of 19 in the Quran
- 2) The mathematical value of only the 4 names of God is a multiple of 19.
- 3) The numbers which are the multiple of 19 in each group, consisting of 4 words, are equal to each other.
- 4) The multiples of 19 in the repetition of words point to Basmalah. This shows why “Gracious” (Rahman) and “Merciful”(Rahim), the names of God, was chosen in Basmalah.
- 5) All the coefficients on both sides of the table are equal to the coefficients of the Basmalah.

The names of God repeated are the multiples of 19	The number of repetitions and mathematical values	The names of God the mathematical of values are multiples of 19
Name	19 (19x1)	One
Allah - God	2698 (19x142)	Possessor of Infinite Grace
Gracious	57 (19x3)	Glorious
Merciful	114 (19x6)	Gatherer
	The total of coefficients 152 (19x8)	
	The total of the all numbers on the table =3040 (19x160)	

“Allah” - God is the word which is repeated the most frequently in the Quran. All the derivatives of the word “God” are used **2698 (19 × 142) times** in the Quran. Today, it is possible to check this number with the help of a computer.

The total of the numbers of the verses which has "God" in it.	118123 (19 x 6217)
---	--------------------

### *Prophet Muhammad’s Name and the Holy Quran*



**114 are the total Suras of the Holy Quran**  
**19 x 6 = 114**

	Sura Number	Verses in that Sura	Suras + Verses
	15	99	114
	39	75	114
	70	44	114
	88	26	114
	107	7	114
<b>Total</b>	<b>319</b>	<b>251</b>	<b>570</b>

**319 + 251 + 570 = 1140**

**19 x 60 = 1140**

The Holy Qur'an was revealed to the humans through the Prophet Muhammad.  
 The numerical Value of the name of Prophet ‘Muhammad’ is **92** and the combination is **408404**

**Muhammad = Mim + Ha + Mim + Dad**

**Muhammad = 40 + 8 + 40 + 4.....408404**

Put **92** and **408404** before the above 3 numbers – **319 251 570**

$$\mathbf{92\ 408404\ 319\ 251\ 570 = 19 \times 4863600227329030}$$

Now move 408404 after the 3 numbers instead.

$$\mathbf{92\ 319\ 251\ 570\ 408404 = 19 \times 4858907977389916}$$

$$\begin{aligned} 4+8+6+3+6+0+0+2+2+7+3+2+9+0+3+0 &=55 \\ 4+8+5+8+9+0+7+9+7+7+3+8+9+9+1+6 &=100 \end{aligned}$$

$$\mathbf{55\ 100 = 19 \times 2900}$$

The result is **2900**. Put the numerical value of Muhammad (**92**) after this number.

$$\mathbf{2900\ 92 = 19 \times 15268}$$

(Reference: [http://numerical19.tripod.com/114\\_surahs\\_verses.htm](http://numerical19.tripod.com/114_surahs_verses.htm))

- We know that the reversal of the Number – 19 is 91. Adding both the numbers, we would get:

$$\mathbf{19 + 91 = 110}$$

The reversal of 110 is 011. Adding both the numbers, we would see:

$$\mathbf{110 + 011 = 121}$$

The numerical value of Prophet Muhammad's name is 92. The reversal of Number – 92 is 29. Adding both the number, we would get:

$$\mathbf{92 + 29 = 121}$$

$$\mathbf{92 + 29 = 121 = 110 + 011}$$

$$\mathbf{11 \times 11 = 121}$$

Allah's smallest name in letters and in numerical value is "**Hu**":

**HU----- 2 Arabic letters**

**Numerical Value of the Arabic name 'Hu' is 11**

## Mercy, Merciful and Gracious

---

The word in the form of “**mercy**” (**rahmet**) derived from the stem of “**RHM**” is used in the Quran. All the derivatives of “mercy” (rahmet) are mentioned 114 times (Rahmet 79 times, rahmetike 3 times, rahmetina 5 times, rahmetini 25 times, rahmeti 2 times).

The name, “**Rahim**” of God also comes from the same stem, **RHM**, and is used exactly half the times these words are mentioned, viz. 57 times. The mathematical miraculous use of these words performs more detailed miracles on the miracle of 19 in the Quran.

### 1- It is a guide and mercy for the believers.

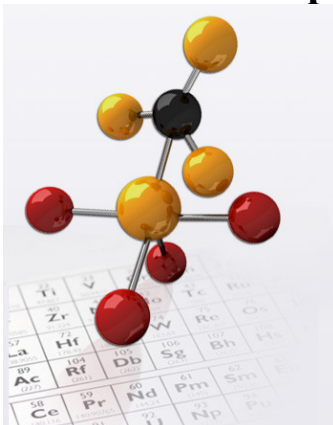
#### (1. The Prologue, Holy Quran)

The word	Number of occurrence
Mercy	114(57X2)
Merciful	114(57X2)
Gracious	57

- Sura (chapter) 19 is the 6th initialed sura with Quranic Arabic initials that was revealed. Note that the 619 is prime number and its index is 114 and that **114 = 6 x 19**. We all know that 114 is the total number of suras (chapters) in the whole Quran. The word 'God' is mentioned for the first time in this sura in verse 30. Note that 30 is the 19th composite. **(19:30)** is the **114th verse** containing the word 'Allah' meaning 'God' in Arabic in the revelation order.



## Holy Quran - Iron's Isotopes and 19



The naturally occurring **iron (Fe)** consists of four isotopes:

- **5.845% of radioactive  $^{54}\text{Fe}$  (half-life:  $>3.1 \times 10^{22}$  years),**
- **91.754% of stable  $^{56}\text{Fe}$ ,**
- **2.119% of stable  $^{57}\text{Fe}$**
- **0.282% of stable  $^{58}\text{Fe}$**

$^{60}\text{Fe}$  is an extinct radionuclide of long half-life (2.6 million years).

The isotope  $^{57}\text{Fe}$  is widely used in Mössbauer spectroscopy due to the low natural variation in energy of the 14.4keV nuclear transition.

### Iron – Fe

#### One of the Stable Isotopes of Iron – 57

As the iron's isotope is encoded in the sura that mentions iron, there is also a sign in that sura.

- The word “**El Hadid**” which means a particular iron has a numerical value of 57. The article “El” corresponds to “the” in English. When the word ‘Hadid’ is used with the article “el”, referring to a specific iron, the mathematical value turns out to be 57.

<b>Alif</b>	<b>=</b>	<b>1</b>
<b>Lam</b>	<b>=</b>	<b>30</b>
<b>Ha</b>	<b>=</b>	<b>8</b>
<b>Da</b>	<b>=</b>	<b>4</b>
<b>Ya</b>	<b>=</b>	<b>10</b>
<b>Da</b>	<b>=</b>	<b>4</b>
<b>Total</b>	<b>=</b>	<b>57</b>

- The sura Iron (hadid) is the **57th sura of the Quran**. And 57 is one of the isotopes of iron.
- The sura Iron (hadid) is the **58th sura** from the end of the Quran. That is another isotope of iron.
- This sura has **29 numbered verses**. This number becomes 30 when the unnumbered 'Basmalah' is counted. This **number is equal to the neutron numbers of two isotopes of iron**, from the total of four. The frequency of the word God in this sura gives the neutron number of the other isotope.

The word	Mathematical value of the word
The iron (el hadid)	57
One of iron's isotopes	57
What is the sura number of the sura the Iron?	57

$$19 \times 3 = 57$$

## Holy Quran - Meton cycle and 19

---

The derivatives of the word 'year' – 'sinet or sinin' are mentioned 19 times in the Quran, the Last Holy Book of Islam. The solar and lunar calendars always need correction because of the occurrence of the leap year. When our world revolves around the sun 365 times, the moon revolves around the earth and itself 12 times. This constitutes one complete year. But when the earth completes its revolution and arrives at the starting point, the moon is behind the schedule. It takes the earth and the moon – 19 years to meet at the same starting point. This cycle of 19 years is called the Meton cycle.

The lunar calendar re-arranged in every 19 years, ends up with 7 leap years – 355 days and 12 full years – 354 days during this period. It is surprising that the singular year – 'Sinet' in Arabic is used 7 times in Quran, whereas the plural year – 'Sinin' is used 12 times in the Holy Book.

And all the derivatives of the word 'year' are used 19 times, an indication of the Meton cycle. The earth lines up with the sun and the moon every 19 years. In the Quran, the words, 'sun' and 'moon' are often used in the same verses, exactly 19 times, the same number that makes a '**Meton cycle**'.



It is also interesting to note that on the 19th time in Quran, these two words are used together, we see the following verse:

**“And the sun and the moon are conjoined.”**  
**(Chapter -75 - The Resurrection, 9)**

It is also interesting that Aristophanes, who wrote a book *Birds*, introduces Meton, the astronomer and discoverer of the Metonic cycle of 19 years, who brings with him a ruler and compasses, and makes a certain construction in order that your circle may become square.

## Quran – Time and 19:

The Arabic word “**yewm**” meaning “a day” is used **365 times** in the Quran. The figure 365 does not only represent the number of days in the calendar, but it is also the figure that shows the **astronomic relationship** between our earth and the sun. When our earth completes its round around the sun, it has revolved 365 times around its own axis. In other words, when the earth has completed its cycle around the sun, this means we have lived 365 days on earth. It is important that the word “one day” has been used 365 times in the Quran, because the earth’s revolution around the sun takes 365 days.

A day	365
The number of the days in which the world completes its revolution around the sun?	365

**B)** The plural of the Arabic word ‘Yewm’ is “eyyam or yewmeyn” is used **30 times in the Quran..** This represents the number of the days in a month which is 30. So it is meaningful that while the singular “day” (yewm) is mentioned 365 times, the plural of it (eyyam, yewmeyn) is mentioned 30 times. In the solar calendar, the months have either 30 or 31 days and in the lunar calendar the months have either 29 or 30 days. So, the **number 30** is the **intersection group** for

both calendars. In the community to which the Quran was revealed, the lunar calendar was in use; the mention of “30” is therefore meaningful. It takes **29.53 days** for the moon to make a month. The rounded figure is 30.

Also the mean of 29, 30 and 31 is Number – 30.

The word	Number of occurrence
Days	30
<b>Number of days in a month</b>	30

C) We saw that the singular “day” (yewm) is mentioned 365 times, and the plural of it, 30 times in the Quran. The use of all the derivatives of the word “day” is **475**. This means that the singular, plural and all the other derivatives totals up to 475. 475 is equal to 19 x 25.

**475 = 19 x 25.....A**

Like the multiplier 19, the **number 25** also has a significant meaning. The days are formed as a result of the relationship between the earth and the sun. The earth revolves around its own axis **365 times** while completing its cycle around the sun and during this time the sun also revolves around itself. As the earth revolves around itself 365 times, how many times the sun must have revolved itself?

**25 times exactly in total**

**25 = 19 + 6 .....A**

On the other hand, the figure 19, multiplier of 25 has an important role within the context of the concept of the relationship between the sun- the earth and day. Because a meton cycle that is when the sun, the earth and the moon come to a same line, occurs in every 19 years. That is to say, the sun turns around itself the number **19 x 25= 475 times in a Meton cycle**.

The word	Number of occurrence
All the derivatives of the word “day”	475 (19x25)
How many times the sun does revolve around itself within a year?	25
How many times does the sun revolve around its own axis in a Meton cycle?	475 (19x25)

D) The derivatives of the word “year”-- ‘**sinet, sinin**’ are mentioned **19 times** in the Quran. The solar and lunar calendars need correction because of the leap year. When the world revolves around the sun 365 times, the moon revolves around the earth and itself 12 times. This constitutes a year. But when the earth completes its revolution and arrives at the starting point,

the moon is behind the schedule.

The word	Number of occurrence
The word Year	19
In how many years a meton cycle occurs?	19

It takes the earth and the moon 19 years to meet at the same starting point. This **cycle of 19 years is called the Meton cycle**. The lunar calendar re-arranged in every 19 years, ends up with 7 leap years (355 days) and 12 full years (354 days) during this period. It is also another surprising characteristic of the miracles that the singular year ‘**sinet**’ is used 7 times, whereas the plural year ‘**sinin**’ is used **12 times** in the Quran. And all the derivatives of the word “year” are used 19 times, an indication of the Meton cycle.

**E)** The Arabic word ‘**Qamar**’ meaning ‘**moon**’, is used exactly **27 times** in the Quran together with its derivatives. This number is equal to the number which is the moon’s ecliptic cycle around the world. The Quran indicates that both the sun and the moon are based on calculation. (Gracious, 55). The sun’s and the moon’s definition in terms of mathematics is interesting and these words in question are mathematically coded in the Quran.

The word	Number of occurrence
Moon	27
How long does the moon’s ecliptic cycle take?	27

**19 is the 8<sup>th</sup> Prime Number. If we add the numbers – 19 and 8, we would get – 27**

$$19 + 8 = 27$$



**Moon**

**F)** The earth’s revolution around the sun makes **365 days** while, **the moon’s 12 revolution** around the earth makes 12 months. The Quran says that there are 12 months in year. As we all know, a year consists of 12 months. On the other hand, in the Quran, the Arabic word “Shahr” meaning ‘**month**’ is also mentioned 12 times to indicate that there are 12 months in a year. The following verse mentions this:

“- ...twelve is the number of months with God..”  
 (9 – Repentance, 36)

The word	Number of occurrence
A month	12
The number of the months or the number of the moon’s revolution around 12 the world in a year	12

The Number – 12 is the 7<sup>th</sup> Even Number. If we add the numbers – 12 and 7, we would get:

$$12 + 7 = 19$$

**19 is the ‘Key Spiritual and Mathematical Number’ used in all the Divine Scriptures from One and Only Almighty God including Torah, Bible and Quran. So it is the Perfect number and code chosen by the Almighty God for His Divine Holy Books.**

### **Mathematical Definition of Quran – The Last Holy Book of Almighty God:**

The Holy Quran can be defined mathematically as:

*Quran is One and Only Last -19th Holy Scripture and mathematically encoded literature of Allah, comprising of 114 suras (19 x 6) and 6346 verses (19 x 334), whose all initials, letters, words, verses and suras are numerically structured and signed with Number 19, by One and Only Almighty Allah, Who revealed His Last - 19th encrypted message on His Last Prophet Muhammad in Arabic language to complete Islam.*



### **The Holy Quran**

There is no need to comment on the spirituality of number ‘Nineteen’ in the Abrahamic religions. Jews religious scholars know the spirituality of this number. Muslim scholars know that Quran revolves around the number 19 and similarly the Christian scholars know the importance of nineteen in Christianity.

*19 is the Key Spiritual and Divine Mathematical number in all the Abrahamic religions.*



## 99 - Names of Allah and 19



There are 99 names of 'Allah' in the Holy Quran.



If we take the 'Abjad' numerical value or gematrical value of 99 Names of 'Allah' in Quran, it would come to **34,200**.

**The 'Abjad' or Numerical value or gematrical value of 99 names of Allah = 34,200.**

## 99 Names of Almighty Allah in the Holy Quran:

The 99 Names of 'Allah' the One and Only God are:

#	Names of Allah	Translation	Arabic Letters	Numerical Value
1	Ar-Rahman	The All Beneficent	4	298
2	Ar-Rahim	The Most Merciful	4	258
3	Al-Malik	The King, The Sovereign	3	90
4	Al-Quddos	The Most Holy	4	170
5	As-Salam	The Peace and Blessing	4	131
6	Al-Mu'min	The Guarantor	4	136
7	Al-Muhaymin	The Guardian, The Preserver	5	145
8	Al-Azeez	The Self Sufficient	4	94
9	Al-Jabbar	The Powerful	4	206
10	Al-Mutakabbir	The Tremendous	5	662
11	Al-Khaliq	The Creator	4	731
12	Al-Bari'	The Rightful + The Maker	4	213
13	Al-Musawwir	The Fashioner of Forms	4	336



14	Al-Ghaffar	The Ever Forgiving	4	1281
15	Al-Qahhar	The All Compelling Subduer	4	306
16	Al-Wahhab	The Bestower	4	14
17	Ar-Razzaq	The Ever Providing	4	308
18	Al-Fattah	The Opener, The Victory Giver	4	489
19	Al-`Aleem	The All Knowing	4	150
20	Al-Qabid	The Restrainer, The Straightener	4	903
21	Al-Basit	The Expander, The Munificent	4	72
22	Al-Khafid	The Abaser	4	1481
23	Ar-Rafi'e	The Exalter	4	351
24	Al-Mu'ezz	The Giver of Honor	3	117
25	Al-Mudhell	The Giver of Dishonor	3	770
26	As-Sami'e	The All Hearing	4	180
27	Al-Baseer	The All Seeing	4	302
28	Al-Hakam	The Judge, The Arbitrator	3	68
29	Al-`Adl	The Utterly Just	3	104

<b>30</b>	<b>Al-Lateef</b>	<b>The Unperceivable</b>	<b>4</b>	<b>129</b>
<b>31</b>	<b>Al-Khabeer</b>	<b>The All Aware</b>	<b>4</b>	<b>812</b>
<b>32</b>	<b>Al-Halim</b>	<b>The Forbearing, The Indulgent</b>	<b>4</b>	<b>88</b>
<b>33</b>	<b>Al-Azeem</b>	<b>The Magnificent, The Infinite</b>	<b>4</b>	<b>1020</b>
<b>34</b>	<b>Al-Ghafoor</b>	<b>The All Forgiving</b>	<b>4</b>	<b>1286</b>
<b>35</b>	<b>Ash-Shakoor</b>	<b>The Grateful</b>	<b>4</b>	<b>526</b>
<b>36</b>	<b>Al-Ali</b>	<b>The Sublimely Exalted</b>	<b>3</b>	<b>110</b>
<b>37</b>	<b>Al-Kabeer</b>	<b>The Great</b>	<b>4</b>	<b>232</b>
<b>38</b>	<b>Al-Hafeez</b>	<b>The Preserver</b>	<b>4</b>	<b>998</b>
<b>39</b>	<b>Al-Muqet</b>	<b>The Nourisher</b>	<b>4</b>	<b>550</b>
<b>40</b>	<b>Al-Hasib</b>	<b>The Reckoner</b>	<b>4</b>	<b>80</b>
<b>41</b>	<b>Al-Jaleel</b>	<b>The Majestic</b>	<b>4</b>	<b>73</b>
<b>42</b>	<b>Al-Kareem</b>	<b>The Bountiful, The Generous</b>	<b>4</b>	<b>270</b>
<b>43</b>	<b>Ar-Raqeeb</b>	<b>The Watchful</b>	<b>4</b>	<b>312</b>
<b>44</b>	<b>Al-Wasse'e</b>	<b>The Vast, The All Encompassing</b>	<b>4</b>	<b>137</b>
<b>45</b>	<b>Al-Hakeem</b>	<b>The Wise</b>	<b>4</b>	<b>78</b>

<b>46</b>	<b>Al-Wadood</b>	<b>The Loving, The Kind One</b>	<b>4</b>	<b>20</b>
<b>47</b>	<b>Al-Majeed</b>	<b>The All Glorious</b>	<b>4</b>	<b>57</b>
<b>48</b>	<b>Al-Ba'ith</b>	<b>The Raiser of The Dead</b>	<b>4</b>	<b>573</b>
<b>49</b>	<b>Ash-Shaheed</b>	<b>The Witness</b>	<b>4</b>	<b>319</b>
<b>50</b>	<b>Al-Ahad</b>	<b>The Incomparable</b>	<b>3</b>	<b>13</b>
<b>51</b>	<b>Al-Wakeel</b>	<b>The Trustee, The Dependable</b>	<b>4</b>	<b>66</b>
<b>52</b>	<b>Al-Qawaie</b>	<b>The Strong</b>	<b>3</b>	<b>116</b>
<b>53</b>	<b>Al-Mateen</b>	<b>The Firm, The Steadfast</b>	<b>4</b>	<b>500</b>
<b>54</b>	<b>Al-Walaie</b>	<b>The Protecting Friend, Patron</b>	<b>3</b>	<b>46</b>
<b>55</b>	<b>Al-Hameed</b>	<b>The All Praiseworthy</b>	<b>4</b>	<b>62</b>
<b>56</b>	<b>Al-Muhsi</b>	<b>The Numberer of All</b>	<b>4</b>	<b>148</b>
<b>57</b>	<b>Al-Mubdi'</b>	<b>The Originator and Initiator of All</b>	<b>4</b>	<b>56</b>
<b>58</b>	<b>Al-Mu'eed</b>	<b>The One Who Brings Back All</b>	<b>4</b>	<b>124</b>
<b>59</b>	<b>Al-Muhyee</b>	<b>The Giver of Life</b>	<b>3</b>	<b>68</b>
<b>60</b>	<b>Al-Mumeet</b>	<b>The Bringer of Death</b>	<b>4</b>	<b>490</b>
<b>61</b>	<b>Al-Hei</b>	<b>The Ever Living</b>	<b>2</b>	<b>18</b>

<b>62</b>	<b>Al-Qeiyoom</b>	<b>The Self Subsisting Sustainer of All</b>	<b>4</b>	<b>156</b>
<b>63</b>	<b>Al-Wajid</b>	<b>The Perceiver, The Finder</b>	<b>4</b>	<b>14</b>
<b>64</b>	<b>Al-Majid</b>	<b>The Illustrious, The Magnificent</b>	<b>4</b>	<b>48</b>
<b>65</b>	<b>Al-Rab</b>	<b>The Nourisher</b>	<b>2</b>	<b>202</b>
<b>66</b>	<b>As-Samad</b>	<b>The Self Sufficient, Everlasting</b>	<b>3</b>	<b>134</b>
<b>67</b>	<b>Al-Qadir</b>	<b>The All Able</b>	<b>4</b>	<b>305</b>
<b>68</b>	<b>Al-Muqtadir</b>	<b>The All Determiner, The Dominant</b>	<b>5</b>	<b>744</b>
<b>69</b>	<b>Al-Muqaddim</b>	<b>He Who Brings Forward</b>	<b>4</b>	<b>184</b>
<b>70</b>	<b>Al-Mu'akhir</b>	<b>He Who Puts Far Away</b>	<b>4</b>	<b>846</b>
<b>71</b>	<b>Al-Awwal</b>	<b>The First</b>	<b>3</b>	<b>37</b>
<b>72</b>	<b>Al-Akhir</b>	<b>The Last</b>	<b>3</b>	<b>801</b>
<b>73</b>	<b>Az-Zahir</b>	<b>The Manifest, The All Victorious</b>	<b>4</b>	<b>1106</b>
<b>74</b>	<b>Al-Batin</b>	<b>The Hidden</b>	<b>4</b>	<b>62</b>
<b>75</b>	<b>Al-Muta'ali</b>	<b>The Self Exalted</b>	<b>6</b>	<b>551</b>
<b>76</b>	<b>Al-Barr</b>	<b>The Most Kind and Righteous</b>	<b>2</b>	<b>202</b>

77	<b>At-Tawwab</b>	<b>The Ever Relenting</b>	<b>4</b>	<b>409</b>
78	<b>Al-Muntaqim</b>	<b>The Avenger</b>	<b>5</b>	<b>630</b>
79	<b>Al-'Afuww</b>	<b>The Pardoner, The Effacer of Sins</b>	<b>3</b>	<b>156</b>
80	<b>Ar-Ra'oof</b>	<b>The Compassionate</b>	<b>4</b>	<b>286</b>
81	<b>Malik-al-Mulk</b>	<b>The Owner of All Sovereignty</b>	<b>9</b>	<b>212</b>
82	<b>Dhu-al-Jalal wa-al-Ikram</b>	<b>The Lord of Majesty and Generosity</b>	<b>16</b>	<b>1095</b>
83	<b>Al-Muqsit</b>	<b>The Equitable, The Requirer</b>	<b>4</b>	<b>209</b>
84	<b>Al-Jami'</b>	<b>The Gatherer, The Unifier</b>	<b>4</b>	<b>114</b>
85	<b>Al-Ghanaie</b>	<b>The All Rich, The Independent</b>	<b>3</b>	<b>1060</b>
86	<b>Al-Mughni</b>	<b>The Enricher, The Emancipator</b>	<b>4</b>	<b>1100</b>
87	<b>Al-Mani'e</b>	<b>The Withholder, The Defender</b>	<b>4</b>	<b>161</b>
88	<b>Ad-Darr</b>	<b>The Distressor</b>	<b>3</b>	<b>1001</b>
89	<b>An-Nafi'e</b>	<b>The Propitious, The Benefactor</b>	<b>4</b>	<b>201</b>
90	<b>An-Noor</b>	<b>The Light</b>	<b>3</b>	<b>256</b>
91	<b>Al-Hadi</b>	<b>The Guide</b>	<b>4</b>	<b>20</b>

92	Al-Badi	The Incomparable, The Originator	4	86
93	Al-Baqi	The Ever Enduring and Immutable	4	113
94	Al-Warith	The Heir, The Inheritor of All	4	707
95	Ar-Rasheed	The Guide, Infallible Teacher	4	514
96	As-Saboor	The Patient, The Timeless	4	298
97	Al-Mutee	The One who is followed	4	129
98	Al-Munem	The One who gives rewards	4	200
99	Al - Haqq	The Truth, The Real	2	108
				<b>34,200</b>

**Total Names – 99**

**Total Numeric Value = 34,200**

**Total Numeric Value of 99 Names of Allah = 34,200 = 19 x 1800**

$$34,200 = 19 \times 1800$$

***Numeric Sum of all 99 Names of Allah - 34,200***

The number 99 written in Hindu-Arabic numeral system is imprinted on human hands. If one looks at his or her palms, thumbs facing upward, the lines in the hands appear as "١٨ ٨١", which are the Hindu-Arabic numerals -commonly used in eastern Arab countries- of **81 and 18**, which sum to 99.



**On Right Palm of every Human Hand**



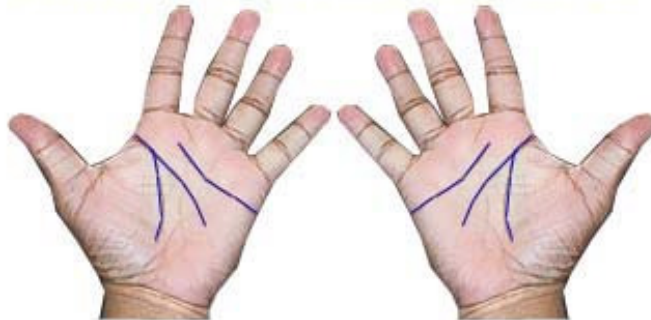
**On Left Palm of every Human Hand**

- If one looks at his or her 'right palm', thumb facing upward, the lines in the hand appear as '1' and '8', which are the Arabic numerals of 1 and 8 or 18.

## Amazing Marks on Your Hands



Look at your hands and identify the outlined marks.



In Arabic, 8 is written as  $\wedge$  and 1 is written as  $|$ . Thus, on your left hand, the marks appear as  $\wedge|$  which can be written as 81 in English. On the right hand, the marks appear as  $| \wedge$ , which can be written as 18. Here is the interesting part, if you were to add 81 and 18, it becomes 99, which is the number of Allah's beautiful names that appear in the Quran. Also, if you subtract 18 from 81, it becomes 63. At the age of 63, Prophet Muhammad (peace be upon him) passed away and the religion of Islam was completed! Amazing, isn't it? It is as if the Kalimah is written on your hands. There is no god but Allah and Muhammad is the messenger of Allah.

$$\text{ﷲ} = 18$$

**On Right Palm of every Human Hand**

$$\text{ﷲ} = 81$$

**On Left Palm of every Human Hand**

‘ﷲ and ﷲ’, which are the Arabic numerals of 1 and 8 or 18

‘ﷲ and ﷲ’, which are the Arabic numerals of 8 and 1 or 81

Adding the numbers – 18 and 81, we would get:

$$\text{ﷲ} + \text{ﷲ} = 99$$

**18 + 81 = 99.....Names of God**

If we place the numbers – 18 and 81 side by side, we get the magical number - 1881:

**18 and 81 ----- 1881**

$$1881 = 19 \times 99$$

**19.....is numerical value of the Arabic name ‘Wahid’ of God**

**99..... Names of God**

**19 x 99 means ‘Wahid’ God has 99 names in the Holy Book - Quran**





**Name of God - ﷲ** - in Arabic language displaying on every Human Hand  
 The numerical value of the Arabic name of God 'Allah' is 66

**Allah's Abjad or Numerical Value = 66**

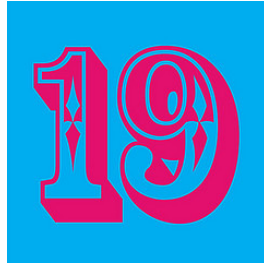
We also know that there are 99 names of Allah. If we upside down the number – 99, we would get:

**99** ----- **66**  
*Names of Allah*

**6619 is a Prime Number:**

*The Number – 6619 is a Prime Number in Mathematics*

## God's Name – Wahid and 19



Allah has 99 names in Quran. One of the names of Allah (God) is called, “Al-Wahid”.

The main message of the Quran is the unity of Allah. The unity of God is expressed by an Arabic word “Wahid” and the mathematical value of the word “**Wahid**” is **19**.

								Alif
Ya	Ta	Ha	Za	Wav	He	Da	Jeem	Ba
Qaf	Sad	Fe	Ayn	Seen	Noon	Meem	Lam	Kaf
Ghayn	Zha	Dwad	Zhal	Kha	Tha	Te	Sheen	Ra

The word “Wahid” is written with the letters ‘wau + alif + he + de’ the total mathematical values of these letters are  $(6 + 1 + 8 + 4) = 19$  as we have mentioned above.

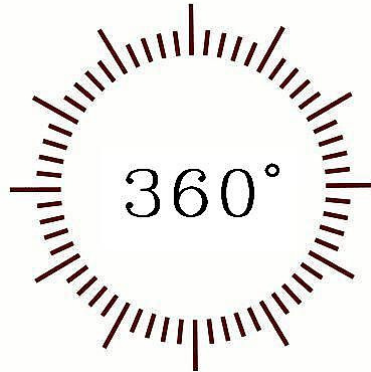
$\begin{aligned} \text{Wav} + \text{Alif} + \text{Ha} + \text{Da} &= \text{total} \\ 6 + 1 + 8 + 4 &= 19 \end{aligned}$
---

The word “Wahid” whose mathematical value is 19 is used 19 times for God in the Quran .The list of these verses is given below in the table.

Serial number	1	2	3	4	5	6	7	8	9	10
Sura and Verse number	<b>2-163</b>	<b>4-171</b>	<b>5-73</b>	<b>6-19</b>	<b>12-39</b>	<b>13-16</b>	<b>14-48</b>	<b>14-52</b>	<b>16-22</b>	<b>16-51</b>
Serial number	11	12	13	14	15	16	17	18	19	
Sura and Verse number	<b>18-110</b>	<b>21-108</b>	<b>22-34</b>	<b>29-46</b>	<b>37-4</b>	<b>38-65</b>	<b>39-4</b>	<b>40-16</b>	<b>41-6</b>	

Other than these verses, the word “Wahid” is used 7 times in the Quran, yet those uses do not refer to the names of God, but other things objects like food and eating materials.

## The Highest Degree and 19



One of the verses of the Quran, points out that God is the possessor of highest degrees. The verse is:

**The Possessor of the highest degrees, and Ruler of the whole dominion. He sends inspiration, bearing His commands, to whomever He chooses from among His Servants to warn about the Day of Gathering.**  
*(The Holy Quran: 40. The Believer, 15)*

“Reify al-daragaat” is translated as “the possessor of the highest degrees”. The word “refii” expresses highness and the word “al-daragaat” expresses the degrees. The mathematical value of “refii”, which states the highest degree, is 360. And this number is the equivalent of the highest degrees in the universe and mathematics. The mathematical values are as follows:

$$\begin{array}{r}
 Re = 200 \\
 Fe = 80 \\
 Ye = 10 \\
 \hline
 Ayn = 70 \\
 \hline
 Sum = 360
 \end{array}$$

The word	The mathematical value of the word
Refii	360
The highest degrees in the universe and mathematics	360

Also only **once in the Quran** did God Almighty choose to call Himself, “**Possessor of the Highest degrees**”.

Is it then a coincident that the numerical or gematrical value of the word “Rafii” in Arabic is 360. This means “**God is the possessor of the highest degrees, the 360 degrees.**” No higher degree than this is possible in mathematics.

## **Relationship between Number 19 and 360 degrees:**

**Number 19 represents 360 degrees and 360 degrees represents Number 19.**

**360 degrees can be expressed and represented in 19 as follows:**

$$360^{\circ} = (19 - 1)^{\circ} \times (19 + 1)$$

<b>Number – 19</b>	<b>represents - 360 degrees</b>
<b>360 Degrees</b>	<b>represents - 19 Number</b>

**So 19 is the representation of 360 degrees and  
360° degrees is the representation of 19.**

Now, one can understand the names that God (Allah) gave Himself in these verses:

**“He (God) is the Alpha and the Omega. He is the Outermost, and the Innermost. He is fully aware of all things.” (Chapter – 57, Verse – 3)**

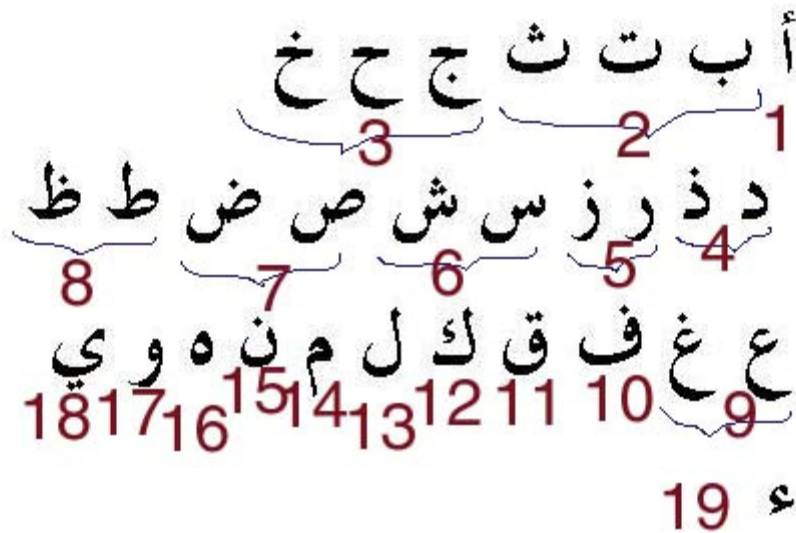
He is surrounding everything i.e. ‘Moheett’ in Arabic. He possesses the Highest degrees i.e. ‘Rafii Al-Daragat’. Glorified, the One God, there is no god besides Him.

## **Conclusion:**

So God is **‘Wahid’**, numerically means **19** and God is also ‘Rafii’, numerically means **360**.



Although the Hamza is considered an ‘alif’, and has the same numeric or gematrical value like an ‘alif’ which is one, it has its unique shape, **the 19th shape**, and can be used in a word independent of the alif. Those who know Arabic know that **Hamza** has its unique shape that is different than the rest of the other alphabets. It can be written **totally separate and independent from the alif** although in many circumstances, it is on top of an alif, a Yaa , a Waw, or under an alif or a Yaa. Using it by itself independent makes it **the 19th shape**. e.g. عَايَاتُ , الْقُرْءَانَ , رُعْيَاكَ , شَيْءٍ , this in addition of using it in the middle of the Quranic words without an alif as an independent alphabet. يَايُسُّ الْخَاطِئِينَ , وَسَّئِلِ الْآئِنَ , أَسْتَيْسُوا



The first writings of the Quran **did not** have the ‘Hamzas’. The ‘Hamzas’ were added later about the **year 786** by **Khalil Ibn Ahmad al-Farahidi**, but they are a major part of the mathematical miracle of the Quran.

The addition of the Hamza is the **same like adding the numbers to the verses of the Quran**, but all their aspects were already calculated and counted by God Almighty, as a part of the miracle of the Quran, which He knows that ‘Hamza’ would be added in the future by the future generations.

**“This is to ascertain that they have delivered their Lord's messages. He is fully aware of what they have. He has counted the numbers of all things.”**

**Quran – (Chapter – 72, Verse – 28)**

If we add the Chapter number and the Verse number, it will become:

**Chapter (Sura) Number + Verse Number = 72 + 28 = 7 + 2 + 2 + 8=19**

The sum or root number of chapter number and verse number = 19

If we note that ‘Hamza’ was added in the **Year – 786**, the number – 786 is again very important in Quran.

786 is the gematrical value of ‘Basmalah’ which contains 19 Arabic letters and is repeated 114 times in The Holy Book of Quran.

**786 – Numeric or Gematric Value of Basmalah = 114 times in Quran = 19 x 6 = 114**

**“We thus revealed it, an ARABIC Quran, and we cited in it all kinds of prophecies, that they may be saved, or it may cause them to take heed.”**

**Quran – (Chapter – 20, Verse – 113)**

**“Before this, the book of Moses provided guidance and mercy. This too is a scripture that confirms, in ARABIC, to warn those who transgressed, and to give good news to the righteous.”**

**Quran – (Chapter – 46, Verse – 12)**

**“In a perfect ARABIC tongue”**

**Quran – (Chapter – 26, Verse – 195)**

In His Final Testament, Almighty God placed the mathematical miracle of the Quran, based on **Number 19** and called it "**One of the great miracles**" 74:35. It would not then be a surprise to find out that God created the Arabic language alphabets, the language of the Quran that will exhibit that 19 based mathematical miracle of the **Quran of 19 different shapes. The Hamza, being the 19th shape.**

***Arabic = Language of the Holy Quran = 19 Different Shapes of Arabic Letters or Alphabets***

## Everything and 19



**361 – 19 x 19 and the Arabic – Word - كُلُّ شَيْءٍ - Every Thing:**

The Almighty God has used this Arabic word – **كُلُّ شَيْءٍ** - meaning ‘Every thing’ – **114 times in The Quran.**

**كُلُّ شَيْءٍ = Every thing = 114 times in Quran = 19 x 6**

Some of the illustrations are as follows:

“We counted EVERYTHING **كُلُّ شَيْءٍ** in a record.”

**Quran – (Chapter – 78, Verse – 29)**

“This is to ascertain that they have delivered their Lord's messages. He is fully aware of what they have. He has counted the numbers of EVERYTHING **كُلُّ شَيْءٍ** (all things.)”

**Quran – (Chapter – 72, Verse – 28)**

“He is the One who created for you EVERYTHING on earth, then turned to the sky and perfected seven universes therein, and He is fully aware of all things.

**Quran – (Chapter – 2, Verse – 29)**

“The One to Whom belongs all sovereignty of the heavens and the earth. He never had a son, nor does He have any partners in sovereignty. He created EVERYTHING in exact



measure; He precisely designed EVERYTHING.”

Quran – (Chapter – 25, Verse – 2)

“EVERYTHING is in accordance with God’s will; He knows what is declared, and what is hidden.”

Quran – (Chapter – 87, Verse – 7)

The Gematrical value of the Arabic words "EVERYTHING" is 361 which is 19 X 19.

$$\text{كُلُّ شَيْءٍ} = \text{Every Thing} = 361 = 19 \times 19$$

The Almighty God insists that EVERYTHING= 19 X 19 and the verses above describe the significance of "EVERYTHING", even when HE counted EVERYTHING, it was 19 X 19. This gives number 19 a great significance in our Universe, life, time, space, sciences and mathematics.

This expression is a reflection of every aspect and of every thing in our Universe, life, time, space, etc that is under control by One and Only Almighty God. A close study of the use of the

expression "everything" كُلُّ شَيْءٍ in the verses in the Quran will clarify its use and its number. The expression EVERYTHING is used in the Arabic Quran in relation to God, His action, and attributes, 114 times, the same number of suras in the Quran.

$$\text{Total Suras (Chapters) in Quran} = 114 = 19 \times 6 = 114$$

Total times the Arabic word كُلُّ شَيْءٍ - Every thing used = 114 (19x6)

“Say, "O followers of the scripture, why do you reject these revelations of GOD, when GOD is witnessing EVERYTHING you do?"

Quran – (Chapter – 3, Verse – 98)

*The Holy Prophet Muhammad (PBUH) said:*

“Everything كُلُّ شَيْءٍ returns to its origin.”

As we know now that the numerical or gematrical value of كُلُّ شَيْءٍ ‘Every thing’ is 361.

If we analyze the sacred encoded saying of Prophet Muhammad (PBUH), we see that in circles every thing started from 0 degrees when returns to its origin, it has to take 360 degrees. In other

words, when we start our journey from 0 degrees in a circle, we have to take 360 degrees to return back at 0 degrees at our origin.

$$\text{Every thing} = 361 = 19 \times 19$$

**In terms of a ‘Circle’ – a perfect shape or a ‘Sphere’ – a perfect solid body, the ‘Returns to its origin’ means travelling from 0 degrees to 360 degrees – a complete round**

Now we write the saying of Prophet Muhammad (PBUH) mathematically, we see:

$$361 \text{ (Everything)} \times 360 \text{ (return to its origin in a circle)} = (360 \times 1) + (360 \times 360)$$

If we write the same mysterious equation in 19 and 6, we see:

$$(19 \times 19) \times (6 \times 6 \times 10) = (1 \times 360) + (360 \times 360) \dots \dots \dots \text{A}$$

$$[(19 \times 19) \times (6 \times 6)] \times 10 = (1 \times 360) + (360 \times 360) \dots \dots \dots \text{B}$$

$$[(19 \times 6) \times (19 \times 6)] \times 10 = (1 \times 360) + (360 \times 360) \dots \dots \dots \text{C}$$

$$[(114) \times (114)] \times 10 = (1 \times 360) + (360 \times 360) \dots \dots \dots \text{D}$$

It is the same equation which I have introduced before as a mathematical proof of formation of new circles.

When **361(Every thing in our Universe)** is multiplied by **Highest degrees – 360 of a circle or a sphere**. Everything would return back to its origin with the **birth of a new circle or sphere** similar to the original one.

So when 361 is multiplied by 360 or when we take 360 rotations around the circle, a new similar new circle is born and the original circle returns back to its origin after taking 360 rotations.

$$361 \text{ degrees} \times 360 \text{ rotations} = (1 \text{ new circle/sphere} \times 360 \text{ degrees}) + (360 \text{ rotations around the same circle/sphere} \times 360 \text{ degrees}) \text{ -----Creation of a new circle/sphere}$$

**Nineteen - 19 encompasses the first numeral - 1 and the last – 9 numeral**

Nineteen (19) numerals look the same in all languages in the world. The numerals One (1) and Nine (9) look very much the same in, for example, Arabic and English.

**One (1) -- Start of every thing, Origin, Unity, Unique, etc**

**Nine (9) -- End of everything, Destination, Final, Last etc**

We can reduce a number or word by a process known as '*digit summing*' in numerology, then reach conclusions based on the single digit that is produced.

**If we add these two numbers:**

$1 + 9 = 10 = 1+0 = 1$  -- Again the beginning or Start or Origin or returns to unity.

**If we multiply these two numbers:**

$1 \times 9 = 9$ -----Again the end or Destination or last of every thing

**The root number of Nineteen (19) is One (1) which is only 1-Perfect Number.**

**Mathematical Rule:**

**Start (01) and End (9) of any thing in the Universe is only written as One – 1 number as Nineteen – 019.**

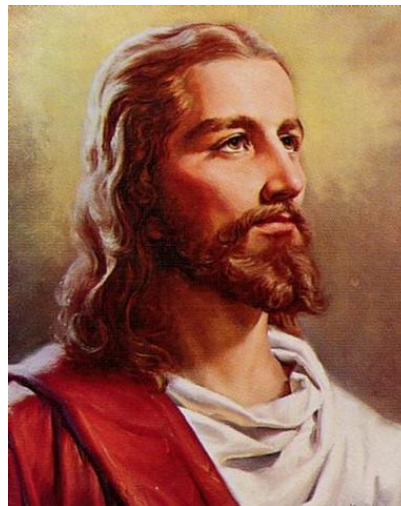
**Start (0 degrees) End (360 degrees) of a complete circle is only written as One – 1 figure as Three Hundred and Sixty degrees – 0360.**

So 19 as one number represent the start and end of any thing in the Universe and 360 degrees as one figure represents complete circle.

## Re-appearance of Jesus Christ and 19



All Christians and Muslims of our World are waiting for the re-appearance of Jesus Christ to save the world and humanity from the Anti-Christ and the injustices of the world. And all the scholars and learned people of both the religions are saying that His re-appearance is very near in the future.



Most of the calculations done in the past indicate the year – 2023 as the expected year of His re-appearance. Number – 7 is considered the lucky number in most faiths of the world especially in the Christian and Islamic faiths. July is the 7<sup>th</sup> Month. Now the dates could be multiples of Number – 7 as: 7<sup>th</sup>, 14<sup>th</sup>, 21<sup>st</sup> and 28<sup>th</sup> – all these four dates can be divided by Number -7, which is considered as the luckiest number. The numbers in the year – 2023 also sum up to 7 as:

$$2023\text{-----} 2 + 0 + 2 + 3 = 7$$

If we take the **expected year of His re-appearance as – 2023**

Expected Month of the year – 2023 – **July – 7<sup>th</sup> Month**

There are only 12 months in a year. If we look for the 19<sup>th</sup> Month, how can we find it? It is simple. The Number – 12 is the 7<sup>th</sup> Even Number. Adding 12 and 7, we would get:

$$12 + 7 = 19$$

The 12<sup>th</sup> Month is December. So adding 7 in the 12<sup>th</sup> Month would be:  
12 + 7 = 19..... December + 7 Months ----- July of the next year

**19<sup>th</sup> Month ----- July**

Expected highest date of the 7<sup>th</sup> Month of the year – 2023 taken as 28..... 7 x 4 = 28<sup>th</sup> July

**2023 7 28..... Year – Month – Date**

If we divide this number by 19, we would get an amazing result:

$$2023\ 7\ 28 = 19 \times 106512$$

**Year of His expected re -appearance– 2023----- 2 + 0 + 2 + 3 = 7**

**Month of His expected re-appearance – 7<sup>th</sup> (July)**

**Date of His expected re-appearance – 28<sup>th</sup> July – 7 x 4 = 28<sup>th</sup> July**

The Number – 23 is also considered as the ‘Cosmic Number’ in Numerology and the most mystic number among the numbers. There is a movie named ‘Number – 23’ and one can see that movie if he or she is looking for the importance of Number – 23.

So the most expected date, month and year of Jesus Christ’s re-appearance which is also divisible by Number – 19 is:

**28<sup>th</sup> July, 2023.....2023 7 28 = 19 x 106512**

### **Conclusion:**

- The year, month and date numbers if written as a single number is divisible by Number – 19
- All the numbers in the year, month and date are linked with Number – 7, which is considered as the luckiest number.
- The year – 2023 -----has Number – 23, which is considered as the ‘Cosmic Number’ in Numerology

$$19 \times 106512 = 2023728$$

## Mathematics and 19



### Mathematical Power of Nineteen - 19 – with 1 and 2:

19 is the sum of the first powers of 9 and 10 and the difference between the second powers of 10 and 9.

- $(9 \text{ power } 1) + (10 \text{ power } 1) = 9 + 10 = 19$
- $(10 \text{ power } 2) - (9 \text{ power } 2) = 100 - 81 = 19$

It is the only number which shows this kind of extra ordinary results.

### The Sum of first 19 Numbers from 1 to 19 is a multiple of 19:

If we add the first 19 numbers from 1 to 19, the result would be Number – 190 which is a multiple of 19.

$$190 = 19 \times 10 = 1 + 2 + 3 + 4 + 5 + 6 + 7 + 8 + 9 + 10 + 11 + 12 + 13 + 14 + 15 + 16 + 17 + 18 + 19 = 190$$

Similarly if we add first 38 numbers ( $38 = 19 \times 2$ ) from 1 to 38, the result would be Number – 741 which is a multiple of 19.

$$741 = 19 \times 39 \text{ ----- the sum of first 38 numbers from 1 to 39.}$$

Then if we add first 57 numbers ( $57 = 19 \times 3$ ) from 1 to 57, the result would be Number – 1653 which is a multiple of 19.

$$1653 = 19 \times 87 \text{ ----- the sum of first 39 numbers from 1 to 57.}$$

Similarly if we add first 76 numbers ( $76 = 19 \times 4$ ) from 1 to 76, the result would be Number – 2926 which is a multiple of 19.

$$2926 = 19 \times 154 \text{ ----- the sum of first 76 numbers from 1 to 76}$$

The results are quite amazing that when we add the numbers from 1 to the Number which is a multiple of 19 for example, 19, 38, 57, 76, etc we get the resulting number which is also a

multiple of 19 like 190, 741, 1653 and 2926 respectively in the above examples.

If we keep on adding in the same pattern of 19, we would get the same results which would be multiples of Number – 19.

19 multiplied by 19 – 19 times:

*When we multiply Number – 19 with Number -19 – 19 times, we get a number:*

$$19 \times 19 \times 19 \times 19 \times 19 \times 19 \times 19 \times 19 \times 19 \times 19 \times 19 \times 19 \times 19 \times 19 \times 19 \times 19 \times 19 \times 19 \times 19 \times 19$$

$$= 19.78419656 \times (10 \text{ power } 23)$$

**The first two numbers of the result is also Number – 19.**

**The sum of the next three numbers – 784 is also 19 as:  $7 + 8 + 4 = 19$ .**

**The next two numbers is Number – 19.**

The Number – 19 is in between the Numbers – 20 and 18. If we write the numbers 20 and 18 side by side, we see:

$$20 \dots 18 \text{-----} 2018$$

$$2018 = 1009 + 1009$$

**Both the twin numbers – 1009 are prime numbers and contain 1 and 9**

**The cube of Number - 19 is:**

$$19 \times 19 \times 19 = 6859$$

- The cube of Number – 16 is:

$$16 \times 16 \times 16 = 4096$$

Adding the numbers of 4096, we see:

$$4096 \dots \dots \dots 4 + 0 + 9 + 6 = 19$$

- The cube of Number – 13 is:

$$13 \times 13 \times 13 = 2197$$

Adding the numbers of 2197, we see:

$$2197 \dots\dots\dots 2 + 1 + 9 + 7 = 19$$

- The cube of Number – 22 is:

$$22 \times 22 \times 22 = 10648$$

Adding the numbers of 10648, we see:

$$10648 \dots\dots\dots 1 + 0 + 6 + 4 + 8 = 19$$

**Rule of Divisibility of 19:**

There is a mathematical formula to determine if a number is divisible by 19. Multiply everything in front of the last digit by nine - 9 and subtract the last digit. If you get zero, nineteen, or a multiple of nineteen, the number will be divisible by 19.

**For example - 57**

Five times nine minus seven equals 38. Since 19 divides evenly into 38, it divides evenly into 57.

**Next example - 114**

Eleven times nine minus four equals 95. Since 19 divides evenly into 95, it divides evenly into 114.

**Another Rule of Divisibility of 19:**

**To test a number (example 660364) for divisibility by 19:**

- Remove the last digit, and then add 2 times that digit to the remaining number:  
66036+ 2×4 = 66044. (Each time you are adding  $19d = (20 - 1)d$  and dividing by 10, where  $d$  is that removed digit.)
- Repeat until it gets down to 20 or less: 6604+2×4 = 6612; 661+2×2 = 665; 66+2×5 = 76; 7+2×6 = 19.
- If this process results in 0 or 19 the original number is a multiple of 19; otherwise it isn't.

*(Reference: <http://mrob.com/pub/math/numbers-4.html>)*



## Mathematical properties of 19



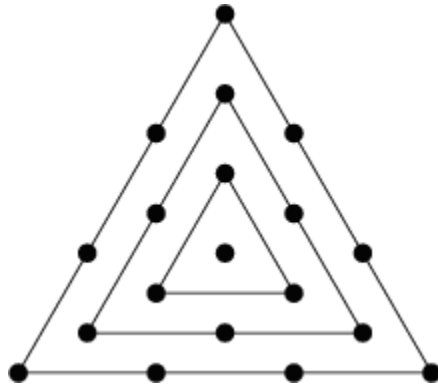
-19 is considered as the highest compound number ever achieved because it contains both the starting number One (1) and ending number Nine (9).

- Halley's Comet passes through the solar system once every 76 years, which is a multiple of 19.

$$19 \times 4 = 76$$

- The Sun, Moon and Earth lineup in the same relative positions **once every 19 years**.

- Nineteen (19) is the 4<sup>th</sup> centered triangular number.



- Nineteen (19) is a centered hexagonal number

- Nineteen (19) is an octahedral number.

- The cube of Nineteen (19) is the sum of the following 19 consecutive odd numbers as:

$$19 \times 19 \times 19 = 6859$$

$$19 \times 19 \times 19 = 343 + 345 + 347 + 349 + 351 + 353 + 355 + 357 + 359 + 361 + 363 + 365 + 367 + 369 + 371 + 373 + 375 + 377 + 379 = 6859$$

-Nineteen (19) is the natural number following 18 and preceding 20. It is an 8<sup>th</sup> prime number.

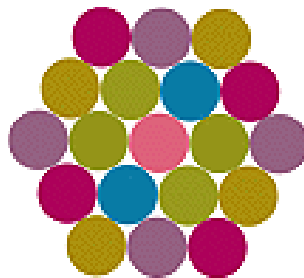
Cardinal	19 nineteen
Ordinal	19 <sup>th</sup> nineteenth
Factorization	prime
Divisors	1, 19
Roman numeral	XIX
Roman numeral (Unicode)	XIX, xix
Binary	10011
Octal	23
Duodecimal	17
Hexadecimal	13

- Nineteen (19) is the 8th smallest prime number, devisable only by itself and one. The sequence continues 23, 29, 31, 37 ..... 19 is the 7th Mersenne prime exponent.

- With respect to divisibility, nineteen (19) has a very simple test. 19 divides  $100a + b$  if and only if it divides  $a + 4b$ .

- Nineteen (19) is Heegner number and a strictly non-palindromic number.

- The decimal expansion of  $1/19$  has a period of maximum length of 18 digits.



This pattern of 19 circles is easy to make with coins. It shows that 19 is a 'centered hexagonal number'.

- Nineteen (19) is also a Keith number because it recurs in a Fibonacci - like sequence started from its base 10 digits: 1, 9, 10, 19.

- Nineteen (19) is the fourth alternating factorial, as it is equal to

$$-(1!) + (2!) + -(3!) + (4!)$$

- The total of the first nineteen (19) *figures* in the Pascal triangle is 38, which is a multiple of 19.

$$19 \times 2 = 38$$

- The total of the first nineteen (19) *numbers* in the Pascal triangle is 57, which is again a multiple of 19.

$$19 \times 3 = 57$$

- Of the 81 permutations exactly 19 cancel out to neutral or tao.

- Of the 27 permutations exactly 19 contain at least one – 1 tao line.

- **The sum of all the points, lines and faces of the 5 platonic solids totals –  $190 = 19 \times 10$ .**

$$190 = 19 \times 10$$

**There are 5 Platonic Solids:**

Solid	v	e	f
Cube	8	12	6
Dodecahedron	20	30	12
Icosahedron	12	30	20
Octahedron	6	12	8
Tetrahedron	4	6	4

- The five – 5 platonic solids + the 13 Archimedean Solids + the surrounding Sphere = **19**.

- The total number of corners of all the platonic and Archimedean Solids =  $608 = 19 \times 32$ .

$$608 = 19 \times 32$$

- The total number of edges + the total number of faces of all the platonic and Archimedean Solids =  $1482 = 19 \times 78$ .

$$1482 = 19 \times 78$$

- 19 is the centered decagonal number

- 19 is the member of the Mian Chawla Sequence, also the **square of 19**.

-  $1111 \times 111^{11} + 111111111 + 1$  (19 ones) is a prime number

-  $2^1 + 3^2 + 5^3 + 7^4 + 11^5 + 13^6 + 17^7 + 19^8$  is a prime number.

-  $19 = 8 + 2 + 8 + 1$ , and its reversal equals the square root of 8281.

**The Square root of (8281) = 91.....Reversal of Number - 19**

-  $(19^{19} - 2^{19}) / (19 - 2)$  is a prime number.

- **String of the first ten odd integers, from 1 up to 19, is a prime (135791113151719) number.**

- An unstable polyhedron is stable on only one face. The simplest such polyhedron known requires 19 faces and was discovered by Richard Guy. None with fewer faces have been found.

## **Unstable polyhedron is stable on only 1 face – with 19 faces**

$$\sqrt{19} \approx 4.3588989435\ 4067355223\ 6981983859\ 6156591370\ 0392523244\ 493689034$$

- The word – “nineteen” contains 8 letters and 19 is the 8<sup>th</sup> Prime Number.

**19 is also:**

- 19----- 19<sup>th</sup> Natural Number (1, 2,.....18,19)
- 18----- 19<sup>th</sup> Integer (0, 1, 2,.....,17, 18)
- 36 ----- 19<sup>th</sup> Even Number (0, 2, 4, 6, 8, .....34,36)
- 37 ----- 19<sup>th</sup> Odd Number (1, 3, 5,.....35, 37)
- 67 ----- 19<sup>th</sup> Prime Number (2, 3, 5,.....61, 67)
- 30 ----- 19<sup>th</sup> Composite Number (4,6,8,.....28,30)
- 144 ----- 19<sup>th</sup> Powerful Number

- The square root of number -19 has the continued fraction expansion...

$$\text{Square root of } 19 = 4 + \frac{1}{2} + \frac{1}{1} + \frac{1}{3} + \frac{1}{1} + \frac{1}{2} + \frac{1}{8} + \frac{1}{2} + \frac{1}{1} + \frac{1}{3} + \frac{1}{1} + \frac{1}{2} + \frac{1}{8} + \frac{1}{2} + \frac{1}{1} + \frac{1}{3} + \frac{1}{1} + \dots$$

And it recurs with length – Six - 6.

The Convergent immediately before the point from which it repeats is 170/39 and Lagrange’s theorem will be the smallest solution to Pell’s equation.

**X= 39 and Y = 170**

**Pell's equation:  $19(x * x) + 1 = (y * y)$  .....[where \* = multiply]**

### **1/19 and the Cyclic Number:**

A Cyclic number – C is an integer that – when multiplied by any number from 1 to the number of digits of ‘C’ – always contains the same digits as ‘C’. Also, these digits will appear in the same order but begin at a different point.

$$1/19 = 0.052631578947368421$$

produces a

**Cyclic Number – 52,631,578,947,368,421**

### **360 degrees and 19:**

$$360^\circ = (19 - 1)^\circ \times (19 + 1)^\circ = 360^\circ$$

### **Warring's Problem and 19:**

Warring conjectured in 1770 that every positive integer can be expressed as a sum of 19 biquadrates (fourth powers). This was later proven by Bal Subramanian, Deshouillers, and Dress

**Every positive integer is the sum of at most 19 fourth powers.**

### **Below the Number – 19:**

- Below the Number – 19, there are **9** positive odd numbers – 1, 3, 5, 7, 9, 11, 13, 15, 17.....

- Below the Number – 19, there are **10** positive even numbers from - 0, 2, 4, 6, 8, 10, 12, 14, 16, 18.....

**So below the Number – 19, there are 19 (odd + even) Numbers as:**

**0, 1, 2, 3.....16, 17, 18, 19**

**0 to 18 (19 Numbers below 19)**

## Prime Numbers and 19



### *19 is the Prime of the Prime Numbers*

Prime number is defined as an integer greater than 1 is called a prime number if its only positive divisors are 1 and itself. For example, the prime divisors of 10 are 2 and 5 and the first eight primes are 2, 3, 5, 7, 11, 13, 17 and 19. The fundamental theorem of arithmetic tells us that all positive integers factor uniquely into a product of primes.

In the integers we can prove:

1. A positive integer  $p$ , not one, is prime if whenever it divides the product of integers  $ab$ , then it divides  $a$  or  $b$ .
2. A positive integer  $p$ , not one, is prime if it can not be decomposed into factors  $p=ab$ , neither of which is 1 or -1.

When we analyze other number systems, these properties may not hold. So in these systems of integers, we often make the following definitions:

1. Any element which divides one is a **unit**.
2. An element  $p$ , not a unit, is **prime** if whenever it divides the product of integers  $ab$ , then it divides  $a$  or  $b$ .
3. An element  $p$ , nonzero and not a unit, is called **irreducible** if it can not be decomposed into factors  $p=ab$ , neither of which is a unit.

### **19 - The 8<sup>th</sup> Prime Wonder:**

**19 ----- |1 - 9|th prime number**

**19 ----- |9 - 1|th prime number**

19 is the 8<sup>th</sup> amazing prime number, which shows so many magical properties and wonders not seen in any other prime number. Here are few examples and illustrations of the role of 19 as a prime number in mathematics.

**- (19 - 1) divides (19<sup>19</sup> - 1) a prime number of times.**

## 19 – The Smallest Prime number:



1. 19 is the smallest prime  $p$  such that  $10 \cdot p \{+ 1, 3, 7, \text{ and } 9\}$  are all primes.
2. 19 is the smallest prime such that  $p$  and  $p^2$  have the same digit sum.
3. The smallest prime that is equal to the product of its digits plus the sum of its digits.
4. 19 is the smallest prime which is the sum of three discrete primes ( $3 + 5 + 11$ ).
5. 19 is the smallest prime whose reversal is composite.
6. The smallest prime using/ending in a composite digit.
7. The smallest number (coincidentally prime) with an additive persistence of 2.
8. The only prime which is equal to the difference of two prime cubes.
9. The smallest invertible prime.
10. The only number or prime for which there is no palindrome with a digit sum  $n$  and beginning with  $n$ .

**1 3 5 7**

**9 11 13**

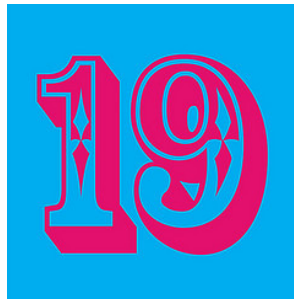
**15 17 19**

11. 19 is the smallest two-digit number such that  $19^{19} + 19 - 1$  is prime.
12. The smallest two-digit prime with a prime ASCII code:  $3139$  (in base 16) = 12601.
13. The smallest prime  $p$  such that  $p^p$  is pan digital.
14. 19 is the smallest super-2 number (curiously prime), i.e., an integer  $n$  such that  $2n^2$  contains 2 consecutive 2s in its decimal representation.
15. 19 is the smallest prime equal to the product of Twin primes plus their arithmetic mean
16.  $(3 \times 5) + 4 = 19$
17. 19 is only number  $m$  such that  $\text{length}(m^{\text{prime}(m)}) = m + \text{prime}(m)$ .
18. 19 is the smallest prime of the form  $3p + 2q$ , where  $p$  and  $q$  are Twin primes.
19. 19 is the smallest prime with a digital root of 1.
20. 19 is the only prime  $p$  less than 30 that does not divide 30, where  $p + 30$  is composite.
21. 19 is the smallest prime mentioned a prime number of times in the *Bible* (KJV).
22. The smallest multi-digit number (coincidentally prime) that does not form a palindrome when added to its reversal.

23. The only two-digit prime  $n$  such that  $n!/\text{reversal}(n)+1$  and  $n!/\text{reversal}(n)-1$  are both prime.
24. The first prime  $p$  such that  $p^2$  is the reversal of a prime (163).
25. 19 is the only known number for which both  $(10^{n-1})/9$  and  $(10^{n+1})/11$  are primes.

## Other Mathematical Properties of 19:

- The recurring decimal cycles for  $1/19$  to  $(19 - 1)/19$  form a true magic square.
- The R-value of standard attic ceiling is 19.
- Blaise Pascal deduced 19 theorems related to his famous triangle.
- $1111 \times 111^{11} + 111111111 + 1$  (19 ones) is a prime.
- The first prime Keith number. A Keith number is an  $n$ -digit integer  $N$  with the following property: If a Fibonacci-like sequence (in which each term in the sequence is the sum of the  $n$  previous terms) is formed, with the first  $n$  terms being the decimal digits of the number  $N$ , then  $N$  itself occurs as a term in the sequence. E.g., if the digits of 19 start a Fibonacci-like sequence, then 19 appears as a term (1, 9, 10, 19). Originally called rep- digit (repetitive Fibonacci-like digit) numbers.
- $2^1 + 3^2 + 5^3 + 7^4 + 11^5 + 13^6 + 17^7 + 19^8$  is a prime.



- The Rhind Papyrus contained a problem to find  $x$  so that  $x$  plus one seventh of it will equal the prime number 19.
- The smallest prime that is equal to the product of its digits plus the sum of its digits.
- $19 = 8 + 2 + 8 + 1$ , and its reversal equals the square root of 8281.
- $19 = 4! - 3! + 2! - 1!$ .
- $19^5 + 19^2 + 19^1 + 19^3 + 19^5 + 19^6 + 19^4 + 19^0 = 52135640$ .



- For  $k = 1, 2, 3, \dots, 19$  at least one of the integers of the form  $6k + 1$  or  $6k - 1$  is prime.
- **The half-life of oxygen-19 is only 19 seconds.**
- 19 divide its following consecutive concatenated composite numbers (202122).
- 19 is the largest prime that can be expressed pan digitally in some base  $b > 1$  ( $19 = 201$  in base 3).
- **$(19^{19} - 2^{19}) / (19 - 2)$  is prime.**
- Waring conjectured in 1770 that every positive integer can be expressed as a sum of 19 biquadrates (fourth powers). This was later proven by Bal Subramanian, Deshouillers, and Dress.
- 19 times its reversal is the famous Hardy-Ramanujan number.
- **19 is the smallest prime which is the sum of three discrete primes (3 + 5 + 11).**
- **19 is the first prime resulting from the sum of cubes of distinct fractions using only primes, i.e.,  $19 = (5/2)^3 + (3/2)^3$ .**
- Inserting seventeen zeros between the two digits of 19 makes another prime of exactly 19 digits. Note that seventeen and 19 are twin primes.
- 1000000000000000009.....Prime Number with 17- Zero's in between 1 and 9.**
- String of the first ten odd integers, from 1 up to 19, is a prime (135791113151719).
- **19 is the smallest prime whose reversal is composite.**
- The smallest prime using/ending in a composite digit.
- The smallest number, coincidentally prime with an additive persistence of 2.
- **The only prime which is equal to the difference of two prime cubes.**
- The decimal expansion of  $19^{19}$  begins with the digits 19. This is not true for  $p^p$ , where  $p$  is any other prime less than 10000019.
- **The smallest invertible prime.**
- **$(2^{19}-1) / (2-1)$  and  $(2^{19}+1) / (2+1)$  are both primes.**
- **The first prime number presenting & meaning the same value within the "Western" world and the "Arabic" is the number 19. All other recognizable prime numbers are with the combination of a 1 and a 9.**

- The 19th Fibonacci number is the smallest  $F(P)$  which is composite where  $P$  is itself prime.
- The only number or prime for which there is no palindrome with a digit sum  $n$  and beginning with  $n$ .
- **19 is the 11 - 9th prime number.**
- **19 is the smallest two-digit number such that  $19^{19}+19-1$  is prime.**
- The sum of 19 consecutive Fibonacci numbers starting from the 19th Fibonacci number is a prime.
- There are exactly 19 primes beginning with the digit 2 among primes smaller than one thousand.
- $19^{19} - 2$  is prime. It starts with the digits 19.
- **$19^2 = 361$  and  $(3 \times 6) + 1 = 19$ .**
- 19 is the largest prime factor of 1444 - the smallest perfect square to end in three 4's. Note that 4 is the only non-zero digit that can repeat at the end of a perfect square, and the most consecutive 4's that can appear in such a place is three.
- The smallest two-digit prime with a prime ASCII code: 3139 (in base 16) = 12601.
- $19^{19} + 19 - 1$  is prime (with prime digital sum). It starts with the digits 19.
- 19 divide the concatenation of the integers from 19 down to 1.
- **$2^{19} - 19$  is prime.**
- The smallest prime  $p$  such that  $p^p$  is pan digital.
- 19 is the smallest super-2 number (curiously prime), i.e., an integer  $n$  such that  $2n^2$  contains 2 consecutive 2s in its decimal representation.
- The largest value of  $n$  less than a thousand, such that  **$2^n+3^n+5^n+7^n$  is prime.**
- 19 is the smallest prime equal to the product of Twin primes plus their arithmetic mean ( $3 \times 5 + 4 = 19$ ).
- 19 is only number  $m$  such that length  $(m^{\text{prime}(m)}) = m + \text{prime}(m)$ .
- 19 is the smallest prime of the form  $3p + 2q$ , where  $p$  and  $q$  are Twin primes.
- **19 is the smallest prime with a digital root of 1.**

- Any number that is divisible by 19 will have this property: multiply the last digit by 2, then add that number to the remaining digits and the resulting number will be divisible by 19. E.g., 625632 is divisible by 19 because all of following results are divisible by 19:  $(62563 + 4 = 62567)$ ;  $(6256 + 14 = 6270)$ ;  $(627 + 0 = 627)$ ;  $(62 + 14 = 76)$ ;  $(7 + 12 = 19)$ ;  $(1 + 18 = 19)$ .

- 19 is the only prime  $p$  less than 30 that does not divide 30, where  $p + 30$  is composite.

-  **$19^{(9+1)} - (9-1)$  is a prime with prime digits.**

-  $19 + 18 + \dots + 1 + 0 = 190$ .

-  **$\phi(19) - \pi(19) = 1 + 9$ . 19 is the only prime with this property.**

- Consider a square made of four rigid rods, hinged at the ends. How many rods of the same type must be added to make the square rigid in the plane? The answer is 19, which makes a total of 23 rods which is also a prime.

- Here is the mathematical code to determine if a number is divisible by 19. Multiply everything in front of the last digit by Nine - 9 and subtract the last digit. If you get zero, nineteen, or a multiple of nineteen, the number will be divisible by 19. For example 57. Five times nine minus seven equals 38. Since 19 divides evenly into 38, it divides evenly into 57. Next example 114. Eleven times nine minus four equals 95. Since 19 divides evenly into 95, it divides evenly into 114.

- 19 is the smallest prime mentioned 6 times in the *Bible* (KJV).

- A gene on Chromosome 19 has been linked to Alzheimer's disease.

- The smallest multi-digit number, coincidentally prime that does not form a palindrome when added to its reversal.

- The only two-digit prime  $n$  such that  $n!/\text{reversal}(n)+1$  and  $n!/\text{reversal}(n)-1$  are both prime.

- Not counting Panno's resignation (1. c4 resigns), Bobby Fischer won 19 consecutive games at the World Championship Inter-zonal tournament and Candidates matches in 1970-71.

- The Fractran algorithm (Conway's prime-producing machine) is an interesting but terribly inefficient way to generate prime numbers. It requires 19 steps to compute the first prime.

- D. H. Lehmer's electromechanical number sieve used 19 bicycle chains.

- **The following are primes: 19, 109, 1009, 10009. No other digit can replace the 9 and yield four primes. [Source: *NUMBERS: Fun & Facts* by J. Newton Friend; Charles Scribner's Sons, New York (1954); Library of Congress Catalog No. 54-8690, p. 45]**

- Farideh Firoozbakht improved the Papadimitriou's conjecture and proposed that every prime number  $p$  greater than or equal to 19 can be written as  $p = 2q + 3r$ , where  $q$  and  $r$  are odd primes.
- An unstable polyhedron is stable on only one face. The simplest such polyhedron known requires 19 faces and was discovered by Richard Guy. None with fewer faces have been found.
- Number – 67 is the 19<sup>th</sup> Prime number.
- The first prime  $p$  such that  $p^2$  is the reversal of a prime (163).
- **19 is the only known number for which both  $(10^n - 1)/9$  and  $(10^n + 1)/11$  are primes.**
- Professor Barabasi and his team have found that the World Wide Web on average has 19 clicks of separation between web pages.

(Source:<http://primes.utm.edu/curios/page.php/19.html>)

## First 1000 prime numbers and 19:

2 3 5 7 11 13 17 **19** 23 29 31 37 41 43 47 53 59 61 67 71 73 79 83 89 97 101 103 107 109 113  
 127 131 137 139 149 151 157 163 167 173 179 181 191 193 197 199 211 223 227 229 233 239  
 241 251 257 263 269 271 277 281 283 293 307 311 313 317 331 337 347 349 353 359 367 373  
 379 383 389 397 401 409 **419** 421 431 433 439 443 449 457 461 463 467 479 487 491 499 503  
 509 521 523 541 547 557 563 569 571 577 587 593 599 601 607 613 617 **619** 631 641 643  
 647 653 659 661 673 677 683 691 701 709 **719** 727 733 739 743 751 757 761 769 773 787 797  
 809 811 821 823 827 829 839 853 857 859 863 877 881 883 887 907 911 **919** 929 937 941 947  
 953 967 971 977 983 991 997 1009 1013 **1019** 1021 1031 1033 1039 1049 1051 1061 1063  
 1069 1087 1091 1093 1097 1103 1109 1117 1123 1129 1151 1153 1163 1171 1181 1187 1193  
 1201 1213 1217 1223 1229 1231 1237 1249 1259 1277 1279 1283 1289 1291 1297 1301 1303  
 1307 **1319** 1321 1327 1361 1367 1373 1381 1399 1409 1423 1427 1429 1433 1439 1447 1451  
 1453 1459 1471 1481 1483 1487 1489 1493 1499 1511 1523 1531 1543 1549 1553 1559 1567  
 1571 1579 1583 1597 1601 1607 1609 1613 **1619** 1621 1627 1637 1657 1663 1667 1669 1693  
 1697 1699 1709 1721 1723 1733 1741 1747 1753 1759 1777 1783 1787 1789 1801 1811 1823  
 1831 1847 1861 1867 1871 1873 1877 1879 1889 1901 1907 1913 1931 1933 1949 1951 1973  
 1979 1987 1993 1997 1999 2003 2011 2017 2027 2029 2039 2053 2063 2069 2081 2083 2087  
 2089 2099 2111 2113 2129 2131 2137 2141 2143 2153 2161 2179 2203 2207 2213 2221 2237  
 2239 2243 2251 2267 2269 2273 2281 2287 2293 2297 2309 2311 2333 2339 2341 2347 2351  
 2357 2371 2377 2381 2383 2389 2393 2399 2411 2417 2423 2437 2441 2447 2459 2467 2473  
 2477 2503 2521 2531 2539 2543 2549 2551 2557 2579 2591 2593 2609 2617 2621 2633 2647  
 2657 2659 2663 2671 2677 2683 2687 2689 2693 2699 2707 2711 2713 **2719** 2729 2731 2741  
 2749 2753 2767 2777 2789 2791 2797 2801 2803 **2819** 2833 2837 2843 2851 2857 2861 2879  
 2887 2897 2903 2909 2917 2927 2939 2953 2957 2963 2969 2971 2999 3001 3011 **3019** 3023

3037 3041 3049 3061 3067 3079 3083 3089 3109 **3119** 3121 3137 3163 3167 3169 3181 3187  
 3191 3203 3209 3217 3221 3229 3251 3253 3257 3259 3271 3299 3301 3307 3313 **3319** 3323  
 3329 3331 3343 3347 3359 3361 3371 3373 3389 3391 3407 3413 3433 3449 3457 3461 3463  
 3467 3469 3491 3499 3511 3517 3527 3529 3533 3539 3541 3547 3557 3559 3571 3581 3583  
 3593 3607 3613 3617 3623 3631 3637 3643 3659 3671 3673 3677 3691 3697 3701 3709 **3719**  
 3727 3733 3739 3761 3767 3769 3779 3793 3797 3803 3821 3823 3833 3847 3851 3853 3863  
 3877 3881 3889 3907 3911 3917 **3919** 3923 3929 3931 3943 3947 3967 3989 4001 4003 4007  
 4013 **4019** 4021 4027 4049 4051 4057 4073 4079 4091 4093 4099 4111 4127 4129 4133 4139  
 4153 4157 4159 4177 4201 4211 4217 **4219** 4229 4231 4241 4243 4253 4259 4261 4271 4273  
 4283 4289 4297 4327 4337 4339 4349 4357 4363 4373 4391 4397 4409 4421 4423 4441 4447  
 4451 4457 4463 4481 4483 4493 4507 4513 4517 **4519** 4523 4547 4549 4561 4567 4583 4591  
 4597 4603 4621 4637 4639 4643 4649 4651 4657 4663 4673 4679 4691 4703 4721 4723 4729  
 4733 4751 4759 4783 4787 4789 4793 4799 4801 4813 4817 4831 4861 4871 4877 4889 4903  
 4909 **4919** 4931 4933 4937 4943 4951 4957 4967 4969 4973 4987 4993 4999 5003 5009 5011  
 5021 5023 5039 5051 5059 5077 5081 5087 5099 5101 5107 5113 **5119** 5147 5153 5167 5171  
 5179 5189 5197 5209 5227 5231 5233 5237 5261 5273 5279 5281 5297 5303 5309 5323 5333  
 5347 5351 5381 5387 5393 5399 5407 5413 5417 **5419** 5431 5437 5441 5443 5449 5471 5477  
 5479 5483 5501 5503 5507 **5519** 5521 5527 5531 5557 5563 5569 5573 5581 5591 5623 5639  
 5641 5647 5651 5653 5657 5659 5669 5683 5689 5693 5701 5711 5717 5737 5741 5743 5749  
 5779 5783 5791 5801 5807 5813 5821 5827 5839 5843 5849 5851 5857 5861 5867 5869 5879  
 5881 5897 5903 5923 5927 5939 5953 5981 5987 6007 6011 6029 6037 6043 6047 6053 6067  
 6073 6079 6089 6091 6101 6113 6121 6131 6133 6143 6151 6163 6173 6197 6199 6203 6211  
 6217 6221 6229 6247 6257 6263 6269 6271 6277 6287 6299 6301 6311 6317 6323 6329 6337  
 6343 6353 6359 6361 6367 6373 6379 6389 6397 6421 6427 6449 6451 6469 6473 6481 6491  
 6521 6529 6547 6551 6553 6563 6569 6571 6577 6581 6599 6607 **6619** 6637 6653 6659 6661  
 6673 6679 6689 6691 6701 6703 6709 **6719** 6733 6737 6761 6763 6779 6781 6791 6793 6803  
 6823 6827 6829 6833 6841 6857 6863 6869 6871 6883 6899 6907 6911 6917 6947 6949 6959  
 6961 6967 6971 6977 6983 6991 6997 7001 7013 **7019** 7027 7039 7043 7057 7069 7079 7103  
 7109 7121 7127 7129 7151 7159 7177 7187 7193 7207 7211 7213 **7219** 7229 7237 7243 7247  
 7253 7283 7297 7307 7309 7321 7331 7333 7349 7351 7369 7393 7411 7417 7433 7451 7457  
 7459 7477 7481 7487 7489 7499 7507 7517 7523 7529 7537 7541 7547 7549 7559 7561 7573  
 7577 7583 7589 7591 7603 7607 7621 7639 7643 7649 7669 7673 7681 7687 7691 7699 7703  
 7717 7723 7727 7741 7753 7757 7759 7789 7793 7817 7823 7829 7841 7853 7867 7873 7877  
 7879 7883 7901 7907 **7919**.

**There are only 27 Numbers in first 1000 prime numbers which end in Number – 19.**

**Number – 19 is the 8<sup>th</sup> Prime Number**

**19 + 8 = 27..... 27 Prime Numbers end in Number – 19,**

**First 19 Prime Numbers and 19:**

The first 19 Prime Numbers are:

**2 3 5 7 11 13 17 19 23 29 31 37 41 43 47 53 59 61 67**

If we add the first 19 Prime Numbers, we would get:

**2 + 3 + 5 + 7 + 11 + 13 + 17 + 19 + 23 + 29 + 31 + 37 + 41 + 43 + 47 + 53 + 59 + 61 + 67 = 568**

**568..... 5 + 6 + 8 = 19**

The Number – 568 is the 285<sup>th</sup> Even Number

**285 = 19 x 15**

**Also 285..... 2 + 8 + 5 = 15**

- The Number – 67 is the 19<sup>th</sup> Prime Number.

**6719.....also a Prime Number**

**6719.....67.....19<sup>th</sup> Prime Number**

## Perfect Numbers and 19



### Perfect Numbers in Mathematics:

A Perfect Number in mathematics is defined as an integer which is the sum of its proper positive divisors, that is, the sum of the positive divisors not including the number itself. A perfect number is a number that is half the sum of all of its positive divisors.

*The number  $n$  is perfect if the sum of all its positive divisors except itself is equal to  $n$ .*

1. The first perfect number accepted in mathematics is Number – 6, because 1, 2 and 3 are its proper positive divisors and  $1 + 2 + 3 = 6$ .

**Number – 6.....First Perfect Number in Mathematics**

2. The next perfect number is Number – 28, because  $28 = 1 + 2 + 4 + 7 + 14$ .

Number – 28 .....Second Perfect Number in Mathematics.

3. The third perfect number is **496**.

Number – 496 .....Third Perfect Number in Mathematics.

4. The fourth perfect number is 8128.

**Number – 8128 .....Fourth Perfect Number in Mathematics**

These first four perfect numbers were the only ones known to the ancient Greeks.

5. The fifth perfect number is 33550336.

**Number – 33550336.....Fifth Perfect Number in Mathematics**

6. The sixth perfect number is 8589869056

Number – 8589869056.....Sixth Perfect Number in Mathematics

The next perfect numbers are:

7. 137438691328.

8. 2305843008139952128.

9. 2658455991569831744654692615953842176.

10. 191561942608236107294793378084303638130997321548169216.

11. 13164036458569648337239753460458722910223472318386943117783728128.

12. 144740111546645244279463731260859884815736774914748358  
89066354349131199152128.

13. 2356272345726734706578954899670990498847754785839260071014302  
7597506337283178622239730365539602600561360255566462503270175  
0528925780432155433824984287771524270103944969186640286445341  
2803383143979023683862403317143592235664321970310172071316352  
7487298747400647801939587165936401087419375649057918549492160  
555646976.

14. 1410537837067120690632079580860631898814867435147156678388386  
7599995486774265238011410419332903769025156195056870982932716  
4087724366370087116731268159313652487450652439805877296207297  
4467232951666582288469268077866528701889208678794514783645693  
1392206037069506473607357237869517647305526682625328488638371  
5072974324463835300053138429460296575143368065570759537328128.

15. 5416252628436584741265446537439131614085649053903169578460392  
0818387206994158534859198999921056719921919057390080263646159  
2800138276054397462627889030573034455058270283951394752077690  
4492443149486172943511312628083790493046274068171796046586734  
8720992572190569465545299629919823431031092624244463547789635  
4414813917198164416055867880921478866773213987566616247145517  
2696430221755428178425481731961195165985555357393778892340514  
6222324506715979193757372820860878214322052227584537552897476  
2561793951766244263144803134469350852036575847982475360211728  
8040378304860287362125931378999490033667394150374722496698402  
8240806042108690077670395259231894666273615212775603535764707  
9522501738583051710286030212348966478513639499289049732921451



## Interesting Points to note in Perfect Numbers:

1. The perfect numbers would alternately end in 6 or 8.
2. Any even perfect number except the first one is the sum of the first  $2^{(n-1)/2}$  odd cubes:

$$\begin{aligned}
 6 &= 2^1(2^2 - 1) = 1 + 2 + 3, \\
 28 &= 2^2(2^3 - 1) = 1 + 2 + 3 + 4 + 5 + 6 + 7 = 1^3 + 3^3, \\
 496 &= 2^4(2^5 - 1) = 1 + 2 + 3 + \dots + 29 + 30 + 31 = 1^3 + 3^3 + 5^3 + 7^3, \\
 8128 &= 2^6(2^7 - 1) = 1 + 2 + 3 + \dots + 125 + 126 + 127 = 1^3 + 3^3 + 5^3 + 7^3 + 9^3 + 11^3 + 13^3 + 15^3.
 \end{aligned}$$

## Relation between the Perfect Numbers and Number – 19:

Now we know that Number- 6 is the first accepted Perfect Number in Mathematics.

We now see other perfect numbers in mathematics and see their relation with Number – 19.

1) For instance, the 3<sup>rd</sup> Perfect Number is 496.

The root number of perfect number 496 is Number – 19 as:

$$496 = 4 + 9 + 6 = 19$$

$$19 = 1 + 9 = 10 = 1 + 0 = 1.$$

2) The 4<sup>th</sup> Perfect Number is 8128.

The root number of perfect number 8128 is also Number – 19 as:

$$8128 = 8 + 1 + 2 + 8 = 19$$

$$19 = 1 + 9 = 10 = 1 + 0 = 1.$$

Also the reversal of Number – 19 is Number – 91 and if we change the arrangement of Numbers in the 4<sup>th</sup> Perfect Number from 8128 to Number – 8281, the square root of 8281 would give the Number – 91, which is the reversal of Number – 19.

**Square root of (8281) = 91.....reversal of Number - 19**

3) The 5<sup>th</sup> Perfect Number is 33550336

The root number of perfect number 33550336 is also Number – 19 as:

$$33550336 = 33 + 55 + 03 + 36 = 127 = 12 + 7 = 19$$

$$19 = 1 + 9 = 10 = 1 + 0 = 1.$$

4) The 6<sup>th</sup> Perfect Number is 8589869056

The root number of perfect number 8589869056 is Number – 19 as:

$$8589869056 = 858 + 986 + 90 + 56 = 1990 = 19 + 90 = 28 \dots \dots \dots 2^{\text{nd}} \text{ Perfect Number}$$

Now the root number of 2<sup>nd</sup> Perfect Number and the root number of 6<sup>th</sup> Perfect Number is the same as the root number of Number – 19

$$\text{The root number of } 2^{\text{nd}} \text{ Perfect Number} - 28 \text{ is: } 28 = 2 + 8 = 10 = 1 + 0 = 1$$

$$\text{The root number of } 6^{\text{th}} \text{ Perfect Number is } 28 = 2 + 8 = 10 = 1 + 0 = 1$$

$$\text{The Number} - 19 \text{ has a root number} - 19 = 1 + 9 = 10 = 1 + 0 = 1$$

We see that either the root number of perfect numbers is Number – 19 as in the case of 3<sup>rd</sup>, 4<sup>th</sup> and 5<sup>th</sup> perfect numbers and the root number of perfect numbers are the same as the root number of Number – 19 as Number – 1 as in the case of 2<sup>nd</sup>, 6<sup>th</sup> perfect number.

***Number – 19 is representation of all Perfect Numbers except Number – 6***

As we have noticed that all Perfect Numbers in Mathematics end either with Number – 6 or Number -8.

All Perfect Numbers in Mathematics end with-----6 or 8

$$\text{Adding 6 and 8, we get ----- } 6 + 8 = 14$$

$$14 \times 14 = 196 \dots \dots \dots \text{Two distinct numbers - 19 and 6}$$

So the sum of the ending numbers in Perfect Numbers when add together gives a number – 14. Multiplying 14 with number – 14, we would get two numbers – 19 and 6. So 19 and 6 are the encoded and encrypted numbers hidden in Perfect Numbers.

**19 = 01.....root number of all Perfect numbers except Number - 6**

## Powerful Numbers and 19



In mathematics, a **perfect number** is defined as an integer which is the sum of its proper positive divisors, that is, the sum of the positive divisors not including the number. Equivalently, a perfect number is a number that is half the sum of all of its positive divisors, or  $\sigma(n) = 2n$ .

A **powerful number** is a positive integer  $m$  that for every prime number  $p$  dividing  $m$ ,  $p^2$  also divides  $m$ . Equivalently, a powerful number is the product of a square and a cube, that is, a number  $m$  of the form  $m = a^2b^3$ . Powerful numbers are also known as **square-full**, or **2-full**.

The following is a list of all powerful numbers between 1 and 1000:

1, 4, 8, 9, 16, 25, 27, 32, 36, 49, 64, 72, 81, 100, 108, 121, 125, 128, **144**, 169, 196, 200, 216, 225, 243, 256, 288, 289, 324, 343, 361, 392, 400, 432, 441, 484, 500, 512, 529, 576, 625, 648, 675, 676, 729, 784, 800, 841, 864, 900, 961, 968, 972, 1000.

The 19<sup>th</sup> Powerful Number in mathematics is Number – 144.

### 144 – 19<sup>th</sup> Powerful Number

144 = 12 x 12.....A

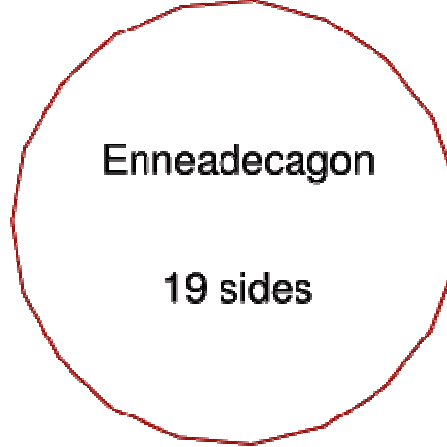
144 = (3 x 3) x (4 x 4)

The root number of Number – 144 is Nine – 9:

144 = 1 + 4 + 4 = 9.....B

**144 is the 19<sup>th</sup> Powerful Number in mathematics.**

## Enneadecagon and 19



In geometry, an **Enneadecagon** is a polygon with **19 sides** and angles. It is also known as an **enneakaidecagon** or a **Nona decagon**. The internal angles of a regular Enneadecagon each measure approximately 161.052 degrees and the area with side length of  $a$  is given by:

$$A = \frac{19}{4}a^2 \cot \frac{\pi}{19} \simeq 28.4652a^2.$$

The radius of the circum-circle of the regular Enneadecagon with side length  $a$  is

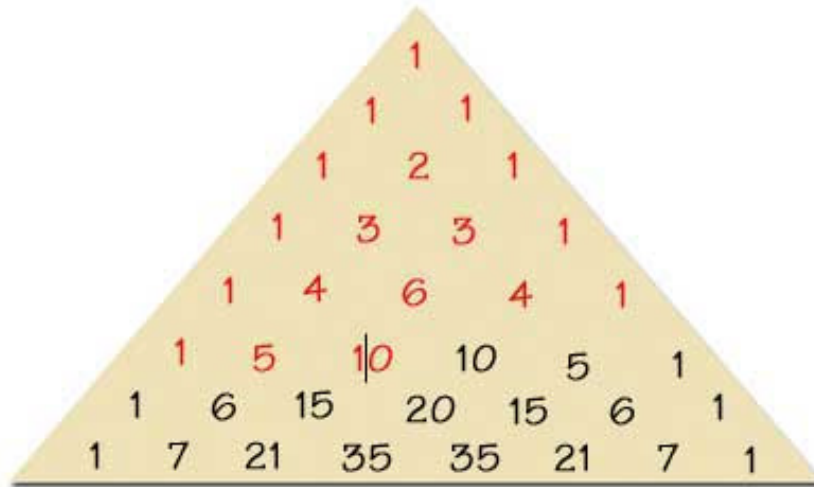
$$R = \frac{a}{2} \csc \frac{180}{19} \text{ (angle measure in degrees)}$$

## Pascal's Triangle and 19



The total of the **first nineteen (19) figures** in the Pascal triangle is 38, which is a multiple of Number - 19.

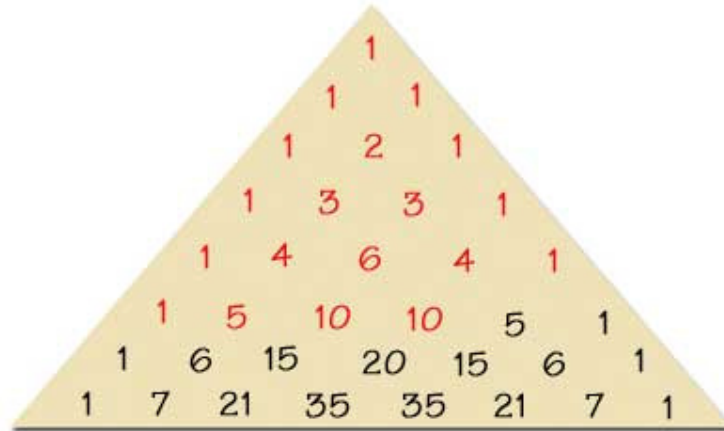
$$19 \times 2 = 38$$



**Figure 1: Pascal's triangle is an arithmetical one used in algebra and probability calculations.**

- The total of **the first nineteen (19) numbers** in the Pascal triangle is 57, which is again a multiple of Number - 19.

$$19 \times 3 = 57$$



**Figure 2: The first 19 figures**

### **Magic Square of Number – 19:**

<b>4</b>	<b>8</b>	<b>1</b>	<b>6</b>
<b>1</b>	<b>6</b>	<b>4</b>	<b>8</b>
<b>6</b>	<b>1</b>	<b>8</b>	<b>4</b>
<b>8</b>	<b>4</b>	<b>6</b>	<b>1</b>

All the rows, columns and the diagonals add to Number - 19

*Pascal was born on June **19**, 1623 and died on August **19**, 1662.*

**“There is no science that teaches the harmonies of nature more clearly than mathematics, and the magic squares are like a mirror which reflects the symmetry of the divine norm immanent in all things, in the immeasurable immensity of the cosmos and in the construction of the atom not less than in the mysterious depths of the human mind”**

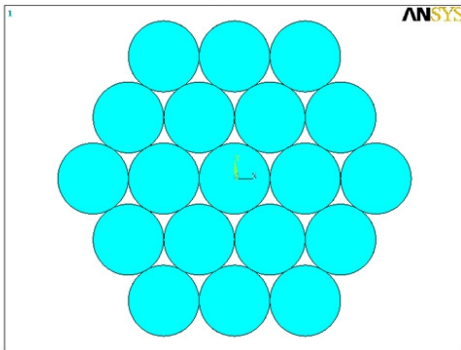
*(Reference: Paul Carus, in W.S. Andrews’s Magic Squares and Cubes)*

# Geometry and 19

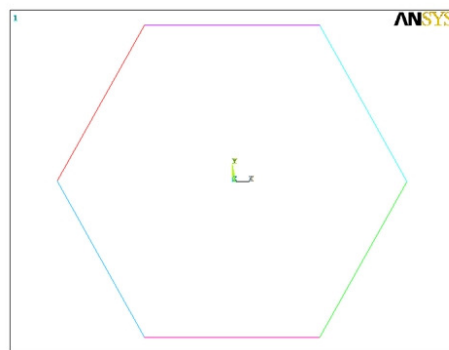
## Number (19) from A Mathematical and Geometrical Perspectives

The Number of 19:

If the number 19 is represented by nineteen spheres then the resulting stable configuration would be a hexagonal one as shown in figure 1 and 2.

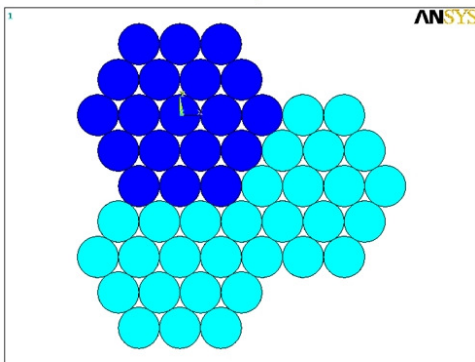


**Figure 1:** The representation of the number 19 by nineteen spheres.

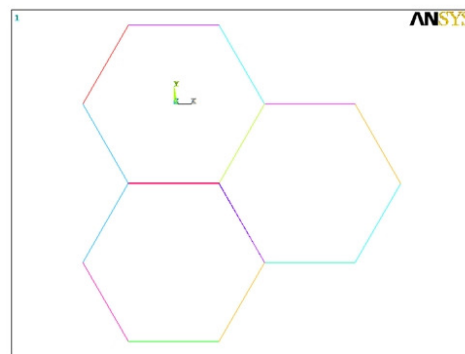


**Figure 2:** The hexagonal geometry resulting from the number 19.

If a number of number 19 units were assembled then the resulting geometrical shape is as shown in figures 3 and 4.



**Figure 3:** Hexagonal shapes resulting from the assembly of 19s.



**Figure 4:** Hexagonal cells resulting from the assembly of the geometry made by the number 19 when represented from a mathematical point of view.

(Reference: Dr. Zaid Kasim Ghazzawi – [www.quran-miracle.com](http://www.quran-miracle.com))

## Number – 01 and 19



$$19 = 1 + 9 = 10 = 1 + 0 = 01$$

$$19 = 01$$

### Comparison between Tables of Number – 1 and Number – 19:

If we compare between the tables of Number- 1 and Number – 19, we can clearly see that both the tables show the same results i.e. in both the tables, the numbers increase by Number - 1.

Now we would compare the tables of Number – 1 and Number – 19:

#### Table of Number- 1:

$$1 \times 1 = 1 \dots \text{Start}$$

$$1 \times 2 = 2$$

$$1 \times 3 = 3$$

$$1 \times 4 = 4$$

$$1 \times 5 = 5$$

$$1 \times 6 = 6$$

$$1 \times 7 = 7$$

$$1 \times 8 = 8$$

$$1 \times 9 = 9$$

$$1 \times 10 = 10 \dots 1 + 0 = 1 \dots \text{End}$$

#### Table of Number – 19:

$$19 \times 1 = 19 \dots 1 + 9 = 10 = 1 + 0 = 1 \dots \text{Start}$$

$$19 \times 2 = 38 \dots 3 + 8 = 11 = 1 + 1 = 2$$

$$19 \times 3 = 57 \dots 5 + 7 = 12 = 1 + 2 = 3$$

$$19 \times 4 = 76 \dots 7 + 6 = 13 = 1 + 3 = 4$$

$$19 \times 5 = 95 \dots 9 + 5 = 14 = 1 + 4 = 5$$

$$19 \times 6 = 114 \dots 1 + 1 + 4 = 6$$

$$19 \times 7 = 133 \dots 1 + 3 + 3 = 7$$

$$19 \times 8 = 152 \dots 1 + 5 + 2 = 8$$

$$19 \times 9 = 171 \dots 1 + 7 + 1 = 9$$

$$19 \times 10 = 190 \dots 1 + 9 + 0 = 10 = 1 + 0 = 1 \dots \text{End}$$



So it is quite clear from both the tables of Number – 1 and Number – 19 that they are showing the same results. Both the tables start from Number – 1 and end on Number – 1

## **Start = 1 = End**

**Start (1) is equal to End (1) in both the tables of Number – 1 and Number – 19**

We can say that mathematically Number -1 and Number – 19 are showing the same results in multiplication. The results are the same.

$$01 = 19..... 19 = 1 + 9 = 10 = 1 + 0 = 01$$

$$19 = 01..... \text{Proved}$$

*“There is no God (01), except One (1) God”*

*One and Only Almighty God – Allah is ‘Wahid’ (01)*

&

*The Abjad or Numerical value of Allah’s name ‘Wahid’ (01) is 19*

الْوَّاحِدُ

**“Over it is Nineteen (19)”**

(Holy Quran, Sura – 74, Verse – 30)

## Number – 8 and 19

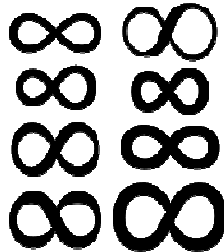


**Number – 19 is the 8<sup>th</sup> Prime number.**

### Infinity and number – 8

A fallen or lying down 8 is used to represent infinity in mathematics. This interpretation of 8 may be related to the representation of the caduceus – where two snakes form several figure eights as stability or balance of opposing forces.

**8 is the only number in mathematics which is used to represent Infinity.**



**The infinity symbol ∞**

The Number 8 is the 3<sup>rd</sup> number in mathematics, which when written upside down does not change its shape. Number – 8 remains 8 if written upside down. 0, 1 and 8 are the only 3 digits in the first 10 digits in mathematics which shows this amazing property.

### Magical Table of Eight - 8

$$1 \times 8 + 1 = 9$$

$$12 \times 8 + 2 = 98$$

$$123 \times 8 + 3 = 987$$

$$1\ 234 \times 8 + 4 = 9\ 876$$

$$12\ 345 \times 8 + 5 = 98\ 765$$

$$123\ 456 \times 8 + 6 = 987\ 654$$

$$1\ 234\ 567 \times 8 + 7 = 9\ 876\ 543$$

$$12\ 345\ 678 \times 8 + 8 = 98\ 765\ 432$$

$$123\ 456\ 789 \times 8 + 9 = 987\ 654\ 321 \text{ (containing all numbers 1 – 9)}$$

## Number – 16 and 19



When written upside down, the Number - 19 becomes Number - 16

**16 --- 19**

There are numbers which don't change when they are written upside down.  
For example,

**0, 1, 8, 11, etc**

When the Number – 19 is written upside down, it will become Number – 16, because 1 in number – 19 would remain 1 and Number – 9 in 19 would become 6.

- $16 = 8 + 8$  .....Where Number – 8 is the only number in Mathematics which represents infinity symbol. A fallen or lying down 8 is used to represent infinity in mathematics.

**8 is a symbol of Infinity in Mathematics when written as lying down 8**

**19.....8<sup>th</sup> Prime Number**

- If we add the first 31 numbers from 1 to 31, we would get a number – 496 which is a multiple of 16 and 31.

$$496 = 31 \times 16 = 1 + 2 + 3 + \dots + 29 + 30 + 31 = 496$$

$$496 = 31 \times 16$$

**496 is also the 4<sup>th</sup> Perfect Number in Mathematics**

**And the root Number of 496 is also Number – 19**

$$496 = 4 + 9 + 6 = 19$$

- 16 is the upside down number of Number – 19 and the reversal of 19 is 91  
If we write both the numbers – 16 and 91 as:

**1691..... 19 x 89**

- 1619 is the Prime Number.....**619** ..... **a Prime Number**

## Number – 57 and 19



$$19 \times 3 = 57$$

- Kevin Brown made a 3 x 3 magic square of 57 x 57

$4^2$	$23^2$	$52^2$
$32^2$	$44^2$	$17^2$
$47^2$	$28^2$	$16^2$

Remarkably, each row and column of this magic square sums to a square number – 3249  
 $57 \times 57 = 57^2 = (19 \times 3)^2 = 3249$

This 3 x 3 magic square of square numbers satisfy the 6 – orthogonal sums so that each row and column sums are equal to 3249-----  $57 \times 57$

$$(19 \times 3) \times (19 \times 3) = 3249$$

- Round numbers are numbers that, when factored, contain a large number of primes. The greater the number of prime factors, the rounder the number.

$$19 - 57$$

1957 – Round Number =  $19 \times 103$

$$1957 = 19 \times 103$$

19 ----- 8<sup>th</sup> Prime Number

103 ----- 27<sup>th</sup> Prime Number

1957 ----- 19 x 103 ----- Product of (8<sup>th</sup> x 27<sup>th</sup>) Prime Numbers

$$8 \times 27 = 216 \text{ ----- } 6 \times 6 \times 6 \text{ ---- Perfect Cube}$$

- There are 57 Even and 57 Odd numbers below the Number 114 and Number – 57 is also the half of the Number – 114.

$$57 \text{ Even} + 57 \text{ Odd} = 114 = 19 \times 6$$

$$(19 \times 3) \text{ Even Numbers} + (19 \times 3) \text{ Odd Numbers} = 114$$

9	20	22	6
15	13	11	18
10	17	16	14
23	7	8	19

**4 x 4 Magic Square of 57**

**(All rows, columns and diagonals add to 57)**

## Number – 81 and 19



### Magic Square of 19 and 81:

The Number – 19 is such an amazing prime number in mathematics that even its decimal periods form a magic square.

The decimal periods of **1/19, 2/19, ..... ,17/19, 18/19** form a true magic square. The row, column, and diagonal sums are all **81**.

### Magic Square of 19 ..... yielding **81** in all directions:

<b>1/19</b>	=	0	5	2	6	3	1	5	7	8	9	4	7	3	6	8	4	2	1
<b>2/19</b>	=	1	0	5	2	6	3	1	5	7	8	9	4	7	3	6	8	4	2
<b>3/19</b>	=	1	5	7	8	9	4	7	3	6	8	4	2	1	0	5	2	6	3
<b>4/19</b>	=	2	1	0	5	2	6	3	1	5	7	8	9	4	7	3	6	8	4
<b>5/19</b>	=	2	6	3	1	5	7	8	9	4	7	3	6	8	4	2	1	0	5
<b>6/19</b>	=	3	1	5	7	8	9	4	7	3	6	8	4	2	1	0	5	2	6
<b>7/19</b>	=	3	6	8	4	2	1	0	5	2	6	3	1	5	7	8	9	4	7
<b>8/19</b>	=	4	2	1	0	5	2	6	3	1	5	7	8	9	4	7	3	6	8
<b>9/19</b>	=	4	7	3	6	8	4	2	1	0	5	2	6	3	1	5	7	8	9
<b>10/19</b>	=	5	2	6	3	1	5	7	8	9	4	7	3	6	8	4	2	1	0
<b>11/19</b>	=	5	7	8	9	4	7	3	6	8	4	2	1	0	5	2	6	3	1
<b>12/19</b>	=	6	3	1	5	7	8	9	4	7	3	6	8	4	2	1	0	5	2
<b>13/19</b>	=	6	8	4	2	1	0	5	2	6	3	1	5	7	8	9	4	7	3
<b>14/19</b>	=	7	3	6	8	4	2	1	0	5	2	6	3	1	5	7	8	9	4
<b>15/19</b>	=	7	8	9	4	7	3	6	8	4	2	1	0	5	2	6	3	1	5
<b>16/19</b>	=	8	4	2	1	0	5	2	6	3	1	5	7	8	9	4	7	3	6
<b>17/19</b>	=	8	9	4	7	3	6	8	4	2	1	0	5	2	6	3	1	5	7
<b>18/19</b>	=	9	4	7	3	6	8	4	2	1	0	5	2	6	3	1	5	7	8

There is a special link between the Number – 19 and Numbers – 18 and 81

If we notice, we see that there are 18 rows and 18 columns and all are yielding the Number – 81 from adding any row or column or any diagonal. The Number 81 is the reversal of 18.

**100 ----- The number which represents ‘Perfection and Completeness’ is:**

$$100 = 81 + 19$$

$$19 = 100 - 81$$

**Also the reversal of 81 is 18. If we write the two numbers – 18 and 81 side by side, we see another magical number:**

$$18...81.....1881 = 19 \times 99$$

$$18 \times 81 = 19 \times 99$$

**Now we will go through an interesting extract from <http://www.answering-christianity.com/fakir60/81.htm> explaining the mysterious relationship between 19 and 81.**

“A man alone, without research assignment and professorship, without any subventions, had discovered everywhere in the Nature the most mysterious number of the Universe. Whether Dr. Peter Plichta examined the depths structure of the biology, the physics or chemistry, he came always across the number of the numbers, the majestic number 19. Like Yin and Yang, which are eternally inseparable and belong to each other, he always found nearby its complementary number 81.

Although the brilliant German, (who one must place with the well known mathematicians like Pythagoras, Leibniz, Euler and Gauss), revealed the complex structure of the numbers 19 and 81 (read chapter "Holy Quran and chemistry"), a question remained unsolved: what is the peculiarity with this both numbers, which follow absolutely the Spirit (Mind) and the Nature?

The question should not remain unanswered.

### **The reciprocal value of 81 is the sequence of the natural numbers**

The unit of this world was nearly to be grasped. Everywhere, could the German thinker see the networked panorama of a World which various fragments have been produced through a few factors. The most exciting in the researches of the lonely thinker was however undoubtedly the interaction between the numbers 81 and 19. It was apparent to him, that all other formulas and numbers are linked to these both poles of the mathematical Universe. Like a watermark, these numbers transfer the phenomena of the Nature with a sealed character - only if we held them on the light of their mathematical common properties.

I remembered a saying from Ibn al-'Arabi: " **In the (material) appearance is somewhat "Translucent" from its concealed background in the observed foreground if one had the right view,(if sufficiently practiced)– that is the view of the Mind.**

After the Plichta's discoveries, it seems to me that some phenomena, give the impression to be re-born - in any case it seems to be till now an unknown wholeness of the Universe construction through them.

The German scientist had the thought, that a purely abstract law, independent of chemistry and physics, determines the course of this Universe. Only the abstract science of the mathematics could bring him to the origin of his discoveries, if really the numbers 81 and 19 , on a level of the pure number theory, are the key for the Universe.

The doctor **Maximus** already knew, that the Nature is co-ruled, by two numbers: 19 and 81. The chemical periods system gave him proofs of that.

**In addition to 19 (19+81=100), the number 81 had also something specific.**

Note: the total sum of their digits is 19:

$$1 + 9 + 8 + 1 = 19$$

Dr. Plichta began to analyze the ratio of the two numbers. If he could find a mathematical law from their ratio, perhaps even a mathematical axiom from this ratio, it would be sensational. Plichta has yet a better idea. He wants to deduce from 81 the natural sequence of the numbers. With this great genius, he would surpass the best mathematicians.

He wanted to know the exact reciprocal value of 19. What he discovered, was spectacular: the numbers 81 and 19 are by the reciprocal value of the 19 together connected! The reciprocal value of the number 19 is:

$$1: 19 = 0.0526315789473684210526....$$

A periodical number, repeating himself after exactly 19 digits after the comma, and its sum

$$(0 + 0 + 5 + 2 + 6 + 3 + 1 + 5 + 7 + 8 + 9 + 4 + 7 + 3 + 6 + 8 + 4 + 2 + 1) = 81$$

Wonderfully 81! The pulse of the researcher speeded.

Because Dr. Plichta always used to calculate automatically the reciprocal value of each number, he decided to use the same principle: he calculated the reciprocal value of 81:

$$1: 81 = 0.012345679.....$$

The numbers 012345679 repeat themselves periodically whereby the number seems to be 8 missing. The number sequence 12345679 interested the **German** mathematician because it looks like to the sequence of the natural numbers. Yet he didn't like the missing 8. Nevertheless he was very near to his objective. After short reflexion, Dr. Peter Plichta writes the result of his calculation in another mathematical possible way:

$$1: 81 = 1 / 9 \times 1 / 9 = 0.111.... \times 0.111.... = 0.0(1)(1+1)(1+1+1)(1+1+1+1)....etc$$



## **1: 81 = 0.123456789(10)(11)(12)(13)...( Cauchy product)**

Here suddenly emerges the missing number 8! And that is really sensational: The reciprocal value of the number 81 (1:81) is the number sequence of the natural numbers - 1,2,3,4,5,6,7,8,9,10,11,12,13... The missing 8 was only an illusion! From the reciprocal value of the number 81 results mathematically the order of the numbers, in which are designed the mathematics and the Nature. With this Dr. Plichta has proved that the decimal system is contained in the Nature and is not at all an human invention. Or, like Plichta says: "if the Room is actually decimal designed, it is not impossible to assume, that the structure of the matter, namely the elements system and their arrangement in Isotopes, are also put in a calculation system."(Read "Prime number Cross" band 2-page 9)

The need of research leads further the discoverer of the "Computing- Nature". He writes the magic number 81 as a reversal fraction of the number 1 and the sequence of natural numbers that begin with two zeros. A zero that indicates the fraction and a second zero, which marks the start of the sequence of natural numbers:

$$\mathbf{1 / 81 = 0.012345678.....}$$

With this shining formula, has Dr. Peter Plichta set up an eternal monument of the code-number 81.

## **The Fifth dimension of the Physics**

Nevertheless his mind was not satisfied. He had to search further, and he found what he sought. The actual highlight is not that from 1/81 are resulting the sequences of the natural numbers, but rather that 81 is the reciprocal value of the sequence of the natural numbers:

$$\mathbf{1 / 0.123456789.... = 81}$$

81 is the "back" of the natural numbers sequence. By multiplying the sequence of natural numbers with 81, the result is

$$\mathbf{1:0.0123456789 \times 81 = 1}$$

"I felt like, as after a long operation the bandages would remove from my eyes". Like Darkness and Light, like Sky and Earth, the sequence of the whole numbers with 81 forms a "Dyad function". Both of them are the Couple of the couples, from where all the calculations-art comes. For all formulas of this world, they are like Adam and Eva. They form together the Tao of the mathematics! Only one number carries the endless progression of the entire natural numbers up to the Infinity...!

It became to me suddenly clear, what a powerful weight possesses the number 81, to be able to balance the counterweight of the sequence of all entire numbers. That it respectively 1 larger becoming sequence of natural numbers deriving of their reciprocal value, makes the number - 81 to a singular number of the mathematics

Therewith is strictly proved that the number 81 is the numeric connection link, which combines to a Unity the mass, energy, room and time. Who now believes that he can bring a more brilliant World construction than his Creator, should better remain silent. The power of the Lord of this World places everything in the shadow, whose creature, the Man, brings into light.”

**(Reference: <http://www.answering-christianity.com/fakir60/81.htm>)**

## Number – 91 and 19



The reversal of Number – 19 is Number – 91.

If we multiply these two numbers, we would get:

**19 x 91 = 1729..... A famous mathematical Ramunujan Hardy Number**

Adding the numbers of 1729, we would again get Number – 19 as:

$$1729..... 1 + 7 + 2 + 9 = 19$$

- **The reversal of 19 is 91 which is also the square root of 8281**

$$91 = \sqrt{8281}$$

$$19 = 8 + 2 + 8 + 1$$

**8128 ----- 4<sup>th</sup> Perfect Number**

Now if we analyze the numbers – 19 and 91, we see that there are two 1's and two 9's in these two numbers.

If we write these two 1's and two 9's in Numbers 19 and 91 in different forms, we see the amazing results:

1. In first case, if we write the numbers in 19 and 91 together, we see:

**1991**

$$1991 = 11 \times 181$$

11 --- 5<sup>th</sup> Prime Number

181 --- 42<sup>nd</sup> Prime Number

2. In Second case, if we take only three numbers from the number - 19 and 91, we see:

**191**

**191 --- 43<sup>rd</sup> Prime Number**

3. In third case, if we write the numbers of 19 and 91 in this order as:

**9191**

$$\mathbf{9191 = 7 \times 13 \times 101}$$

7 --- 4<sup>th</sup> Prime number

13 --- 6<sup>th</sup> Prime Number

101 --- 26<sup>th</sup> Prime Number

4. In fourth case, if we write the numbers of 19 and 91 as:

**9119**

$$\mathbf{9119 = 11 \times 829}$$

11 ---- 5<sup>th</sup> Prime Number

829 --- 145<sup>th</sup> Prime Number

5. In fifth case, if we write the numbers of 19 and 91 as:

**1919**

$$\mathbf{1919 = 19 \times 101}$$

19 – 8<sup>th</sup> Prime Number

101 – 26<sup>th</sup> Prime Number

6. In sixth case, if we write the numbers of 19 and 91 as:

**9911**

$$9911 = 11 \times 17 \times 53$$

11 --- 5<sup>th</sup> Prime Number  
17 --- 7<sup>th</sup> Prime Number  
53 --- 16<sup>th</sup> Prime Number

7. In seventh case, if we write the numbers of 19 and 91 as:

$$1199$$

$$1199 = 11 \times 109$$

11 --- 5<sup>th</sup> Prime Number  
109 --- 29<sup>th</sup> Prime Number

8. In eighth case, if we write the numbers of 19 and 91 by taking only 3 numbers from them as:

$$119$$

$$119 = 7 \times 17$$

7 --- 4<sup>th</sup> Prime Number  
17 --- 7<sup>th</sup> Prime Number

9. In ninth case, if we write the numbers of 19 and 91 by taking only 3 numbers from them as:

$$911$$

$$911 = 156^{\text{th}} \text{ Prime Number}$$

**911 ----- Emergency Number in USA and in some other countries**

## Number – 110 and 19



The reversal of the Number – 19 is Number – 91. If we add these two numbers, we would get an amazing number – 110

$$19 + 91 = 110$$

### Magic Square of 110

36	41	33
34	37	39
40	33	38

All rows, columns, and diagonals add to 110.

### Magical Formula of Number – 110 (19 + 91) with all numbers:

We would get the resulting Number – 110 from all the numbers, if we apply the given formula:

Take any number and multiply by number – 12. For example, take the number – 19 and now multiply with number – 12, we would get:

$$19 \times 12 = 228$$

Now Add Number – 1 to the resulting number. So,

$$228 + 1 = 229$$

Now Multiply Number – 5 to the resulting number. We would get:

$$229 \times 5 = 1145$$

Now Divide the resulting number with Number – 20 and we would get a remainder of 5

$$1145 \div 20 = \text{Remainder} - \text{Number} - 5$$

Now Multiply the remainder Number – 5 with Number – 22 and we would get again Number – 110

$$5 \times 22 = \mathbf{110}$$

This is a constant formula with all the natural numbers in mathematics.

### **Magical Formula of Number – 110 (19 + 91)**



$$\text{Any number} \times 12 = M$$

$$M + 1 = N$$

$$N \times 5 = P$$

$P \div 20 = Q$  and the Remainder would always be Number - 5

$$5 \times 22 = \mathbf{110}$$

**Take another example by taking Number – 92:**

$$92 \times 12 = 1104$$

$$1104 + 1 = 1105$$

$$1105 \times 5 = 5525$$

$5525 \div 20$  ----- and the remainder number is again – Number – 5

$$5 \times 22 = 110$$

And  $110 = 19 + 91 = \text{Sum of number} - 19 \text{ and its reversal number} - 91$

- **110 is also the sum of the squares of three consecutive numbers, i.e.**

$$110 = 19 + 91 = (5 \times 5) + (6 \times 6) + (7 \times 7)$$

The Number – 110 (19 + 91) can also be written as:

$$110 = 19 + 91$$

$$110 = 28 + 82 \text{ (The reversal of Number} - 28 \text{ is Number} - 82)$$

$$110 = 37 + 73 \text{ (The reversal of Number} - 37 \text{ is Number} - 73)$$

$$110 = 46 + 64 \text{ (The reversal of Number} - 46 \text{ is Number} - 64)$$

$$110 = 55 + 55 \text{ (The reversal of Number} - 55 \text{ is Number} - 55)$$



## Number - 114 and 19



$$19 \times 6 = 114$$

- 3 x 3 Magic Square of 114 x 114

$8^2$	$46^2$	$104^2$
$64^2$	$88^2$	$34^2$
$94^2$	$56^2$	$32^2$

Remarkably, each row and column of this magic square sums to a square number – 12996

$$114 \times 114 = 114^2 = (19 \times 6)^2 \dots\dots\dots 12996$$

This 3 x 3 magic square of square numbers satisfy the 6 – orthogonal sums so that each row and column sums are equal to 12996----  $114 \times 114 = (19 \times 6) \times (19 \times 6)$

- 114<sup>th</sup> Prime Number is 619. The Number contains two numbers: 6 and 19

**6 – 19..... 619 is the 114<sup>th</sup> Prime Number**

$$6 \times 19 = 114$$

24	34	35	21
29	27	26	32
25	31	30	28
36	22	23	33

**4 x 4 Magic Square of 114 (19 x 6)**  
**(All rows, columns, and diagonals add to 114 = 19 x 6)**

- There are 30 prime numbers below the Number – 114. The Number 30 is the 19<sup>th</sup> Composite Number in mathematics.

**30 is the 19<sup>th</sup> Composite Number in mathematics**

- **3019 is a Prime Number**

**Prime Number -----3019-----30 is a 19<sup>th</sup> Composite Number**

## Magical Table of Number – 19:



The magical table of Number – 19 is as follows:

$$\begin{aligned}19 \times 1 &= 19 = 9 + 10 \\19 \times 2 &= 38 = 8 + 9 + 10 + 11 \\19 \times 3 &= 57 = 7 + 8 + 9 + 10 + 11 + 12 \\19 \times 4 &= 76 = 6 + 7 + 8 + 9 + 10 + 11 + 12 + 13 \\19 \times 5 &= 95 = 5 + 6 + 7 + 8 + 9 + 10 + 11 + 12 + 13 + 14 \\19 \times 6 &= 114 = 4 + 5 + 6 + 7 + 8 + 9 + 10 + 11 + 12 + 13 + 14 + 15 \\19 \times 7 &= 133 = 3 + 4 + 5 + 6 + 7 + 8 + 9 + 10 + 11 + 12 + 13 + 14 + 15 + 16 \\19 \times 8 &= 152 = 2 + 3 + 4 + 5 + 6 + 7 + 8 + 9 + 10 + 11 + 12 + 13 + 14 + 15 + 16 + 17 \\19 \times 9 &= 171 = 1 + 2 + 3 + 4 + 5 + 6 + 7 + 8 + 9 + 10 + 11 + 12 + 13 + 14 + 15 + 16 + 17 + 18 \\19 \times 10 &= 190 = 0+1+2+3+4+5+6+7+8+9+10+11+12+13+14+15+16+17+18+19 \\19 \times 11 &= 209 = -1 + 0+1+2+3+4+5+6+7+8+9+10+11+12+13+14+15+16+17+18+19+20 \\19 \times 12 &= 228 = (-2) + (-1) + 0+1+2+3+4+5+6+7+8+9+10+11+12+13+14+15+16+17+18+19+20+21 \\19 \times 13 &= 247 = (-3)+(-2)+(-1) + 0+1+2+3+4+5+6+7+8+9+10+11+12+13+14+15+16+17+18+19+20+21+22 \\19 \times 14 &= 266 = (-4)+(-3)+(-2)+(-1) + 0+1+2+3+4+5+6+7+8+9+10+11+12+13+14+15+16+17+18+19+20+21+22+23\end{aligned}$$

If we analyze this amazing magical table of Number – 19, we conclude the following results:

- The sum of first and the last numbers in the series are always Number – 19. For example, the sum of Numbers – 9 and 10 is 19, the sum of numbers – 8 and 11 is again 19, the sum of numbers – 7 and 12 is also number – 19 and so on
- In equation –  $19 \times 10$ , the sum of first number – 0 and the Number – 19 is again Number 19. Similarly in equation –  $19 \times 11$ , the sum of first number (-1) and the last number 20 is again – Number – 19 ( $-1 + 20 = 19$ )
- The numbers in the table are the consecutive numbers, i.e.

9 and 10 in  $19 \times 1$ ,  
8, 9, 10 and 11 in  $19 \times 2$ ,  
7, 8, 9, 10, 11, 12 in  $19 \times 3$  and so on

## Multiples of 19



**19 x 1 = 19**

19 is the maximum number of 4<sup>th</sup> powers needed to sum to any number.

**19 x 2 = 38**

38 is the last Roman numeral when written lexicographically.

**19 x 3 = 57**

57 is 111 in base 7.

**19 x 4 = 76**

76 is an automorphic number.

**19 x 5 = 95**

95 is the number of planar partitions of 10.

**19 x 6 = 114**

114 = 222 in base 7

**19 x 7 = 133**

133 is the smallest number n for which the sum of the proper divisors of n divides  $\phi(n)$ .

**19 x 8 = 152**

152 has a square composed of the digits 0-4.

**19 x 9 = 171**

171 has the same number of digits in Roman numerals as its cube.

**19 x 10 = 190**

190 is the largest number with the property that it and its distinct prime factors are palindromic in Roman numerals.

**19 x 11 = 209**

209 is the smallest quasi-Carmichael number in base 9.

**19 x 12 = 228**

228 is the number of ways, up to rotation and reflection, of dissecting a regular 11-gon into 9 triangles.

**19 x 13 = 247**

247 is the smallest possible difference between two integers that together contain each digit exactly once.

**19 x 14 = 266**

266 is the Sterling number of the second kind S(8,6).

**19 x 15 = 285**

285 is the number of binary rooted trees with 13 vertices.

**19 x 16 = 304**

304 is a primitive semi-perfect number.

**19 x 17 = 323**

323 is the smallest composite number  $n$  that divides the  $(n+1)^{\text{st}}$  Fibonacci number.

**19 x 18 = 342**

342 is the number of inequivalent binary linear codes of length 8.

**19 x 19 = 361**

361 is the number of intersections on a Go board.

**19 x 20 = 380**

380 is the number of necklaces possible with 13 beads, each being one of 2 colors.

**19 x 21 = 399**

399 is a Lucas-Carmichael number.

**19 x 22 = 418**

418 has the property that the sum of its prime factors is equal to the product of its digits.

**19 x 23 = 437**

437 has a cube with the last 3 digits the same as the 3 digits before that.

**19 x 24 = 456**

456 is the number of tournaments with 7 vertices.

**19 x 25 = 475**

475 has a square that is composed of overlapping squares of smaller numbers.

**19 x 26 = 494**

494 is the number of unlabeled distributive lattices with 14 elements.

**19 x 27 = 513**

513 is the number of conjugacy classes of the alternating group  $A_{22}$ .

**19 x 28 = 532**

532 is a hendecagonal pyramidal number.

**19 x 29 = 551**

551 is the number of trees with 12 vertices.

**19 x 30 = 570**

570 is the product of all the prime palindromic Roman numerals.

**19 x 31 = 589**

589 is a centered tetrahedral number.

**19 x 32 = 608**

608 is a number that does not have any digits in common with its cube.

**19 x 33 = 627**

627 is the number of partitions of 20.

**19 x 34 = 646**

646 is the number of connected planar graphs with 7 vertices.

**19 x 35 = 665**

665 is a member of the Fibonacci-type sequence starting with 1 and 4.

**19 x 36 = 684**

684 is the sum of 3 consecutive cubes.

**19 x 37 = 703**

703 is a Kaprekar number.

**19 x 38 = 722**

722 is the sum of the 4<sup>th</sup> powers of the first 3 primes.

**19 x 39 = 741**

741 is the number of multigraphs with 6 vertices and 8 edges.

**19 x 40 = 760**

769 is the number of partitions of 37 into distinct parts.

$$19 \times 41 = 779$$

779 is the product of 8<sup>th</sup> Prime Number and 13<sup>th</sup> Prime Number i.e. 19 and 41.

$$19 \times 42 = 798$$

798 is the number of ternary square-free words of length 16.

$$19 \times 43 = 817$$

817 is the product of 8<sup>th</sup> Prime Number and 14<sup>th</sup> Prime Number i.e. 19 and 43.

$$19 \times 44 = 836$$

836 is a non-palindrome with a palindromic square.

$$19 \times 45 = 855$$

855 is the smallest number which is the sum of 5 consecutive squares or 2 consecutive cubes.

$$19 \times 46 = 874$$

874 is the number of positive integer solutions to  $(1 + 1/a)(1 + 1/b)(1 + 1/c)(1 + 1/d)(1 + 1/e) = 2$ .

$$19 \times 47 = 893$$

893 has a square whose digits each occur twice.

$$19 \times 48 = 912$$

912 is a Pentanacci number.

$$19 \times 49 = 931$$

931 is the product of 10<sup>th</sup> Odd Number and 25<sup>th</sup> Odd Number, i.e. 19 and 49

$$19 \times 50 = 950$$

950 is the generalized Catalan number  $C(17,3)$ .

$$19 \times 51 = 969$$

969 is a tetrahedral palindrome.

$$19 \times 52 = 988$$

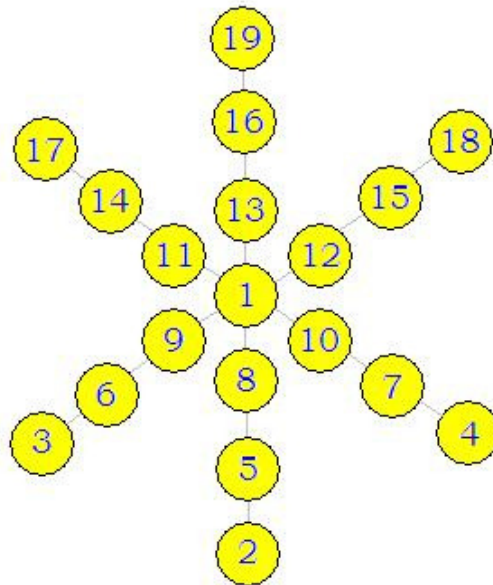
988 is the maximum number of regions a cube can be cut into with 18 cuts.

$$19 \times 53 = 1007$$

1007 is the product of 10<sup>th</sup> Odd Number and 27<sup>th</sup> Odd Number, i.e. 19 and 53.

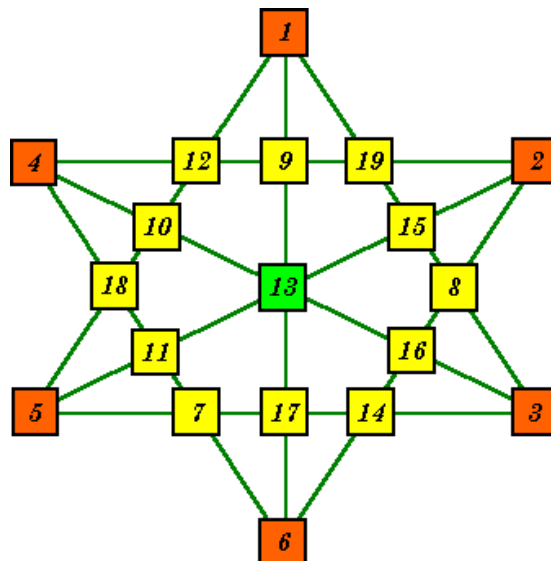
*(Reference: <http://www2.stetson.edu/~efriedma/numbers.html>)*

## Magic Stars and 19



This magic star is composed of the numbers 1 to 19. It adds to 64 along every line. Each circle+ the center also= 64.

*Another Magic Star and 19:*

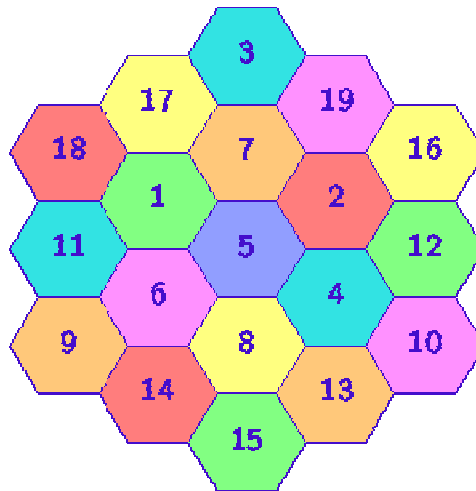


**This magic star is composed of the numbers 1 to 19. It adds to 46 along every line.**

## **19 and Magic Hexagon:**

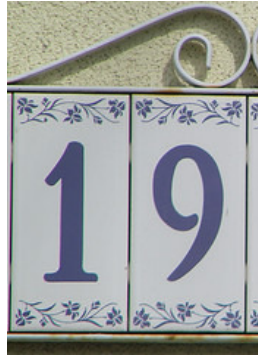
There is only one numerically linear magic hexagon. It consists of the numbers 1- 19 so arranged that they add to 38 i.e.  $19 \times 2 = 38$  in every direction.

$$38 = 19 \times 2$$

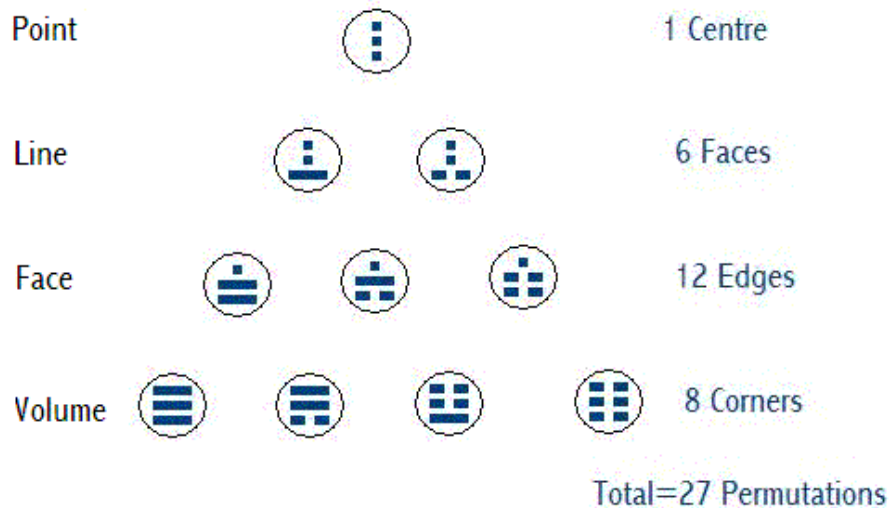




## Magic Hexagon of the 19 Tao Imbued Permutations



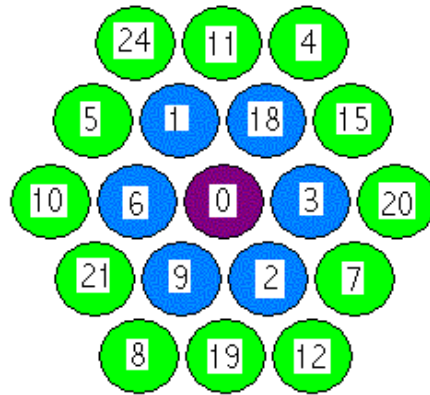
The 27 Permutations consist of 10 groups of equal ratio. As you can see, the 10 ratios correspond exactly to the 10 parts of the Pythagorean Tetraktis as well as the 10 sephir of the Tree of Life.



Note that only the top 3 levels of the Tetraktis contain at least one tao bindu. These levels contain 19 (i.e. 1 + 6 + 12) trinary permutations.

The 19 Tao imbued permutations can be arranged into a magic hexagon thus:

Magic Hexagon of the 19 Tao Imbued Permutations  
(Translated from Base 3)



Adds to 39 in every direction

Note that as with the traditional magic hexagon this diagram may be shown in any one of 12 reflections/alignments. The alignment above was chosen arbitrarily as the significance of the positional variations is not yet known. Also the colors chosen do not indicate a specific frequency etc but are meant only to be suggestive and for reasons of clarity.

### The Inner Circle:

The inner circle corresponds with the apex of the Tetraktis, the point and the centre of the cube of space. It also corresponds with one of the 7 Hebrew double letters.

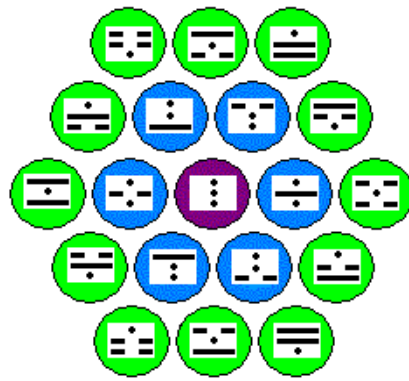
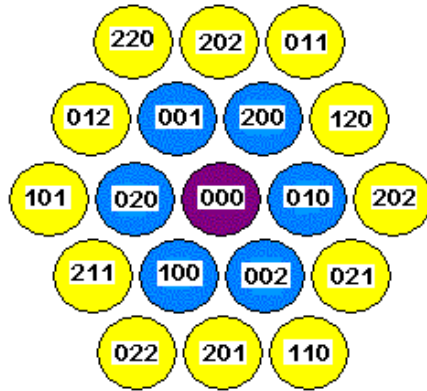
### The 6 Middle Circles:

The 6 middle circles correspond with the 2nd level of the Tetraktis and the 6 faces of the Cube of Space. They also correspond with 6 of the seven Hebrew double letters.

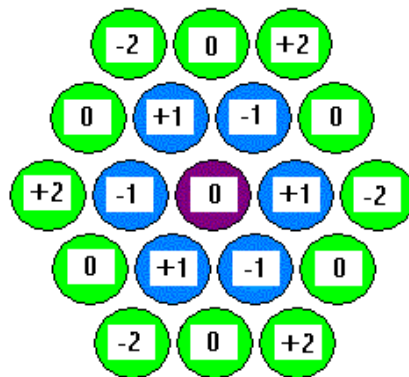
### The Outer 12 Circles:

The 12 outer circles correspond with the 3rd level of the Tetraktis and the 12 edges of the Cube of Space. They also correspond with the 12 Hebrew simple letters and the 12 signs of the zodiac etc.

As you can see the above diagram is numbered in base 10. If you convert the diagram back into base 3 and use the key 0= Tao, 1=yang and 2=yin you will see that the permutations cancel out to Tao in every direction!



This diagram has exactly the same configuration but shows the polarity values.



## Numerology and 19



In terms of numerology, 19 is the number derived from subtracting the Ultimate Answer of Life, the Universe, and everything - 42, and the supposed mystical and cosmic number - 23.

**Everything (42) – Cosmic Number (23) = Answer of Universe**

**19 = 42 – 23 = Answer of Universe**

“Number 19 in numerology is one of the special number, because its so unique from the rest of the numbers. There is one distinct characteristic about this number, a beautiful one, which every person in this world longs to have. Number 19 comes under the family of 1 in numerology. We know that number 1 is ruled by planet sun. Number 19 in numerology is called as ” The Rising Sun” which means that the sun never dusks, and the person with this name as 19 will always rise in their life. Another important name to this number 19 is **Prince of Heaven**.

Number 19 is called as the prince of heaven in many Vedic scriptures as well as **The Ideal Lover**. Number 19 is the ideal lover in numerology; this is the most unique aspect of this number. Person with name as 19 are the greatest lovers of the world. They love their partner more than anything, they are the ideal lovers and the most loyal, trustworthy, caring, and love their partner whatever it may come. They will not stop loving their lover’s till they die, the love is immortal in their life. Woman or Men with name 19 are the luckiest ones to be married or to be loved, as they consider their loved ones as the most important part in their life.

In this world of Infidelities and false love number 19 stands apart with purest love. Person with number 19 in their name will be blessed with beautiful life partner, great wealth, happy family, social status and high post in their job. They will look very young and tends to grow younger as their age goes high.”

(Reference: <http://astronlogia.com/2009/01/25/number-19-the-prince-of-heaven/>)

*Nineteen (19) is symbolized as the Sun in numerology and is called the Prince of Heaven*

## Partitions and 19



**Partition theory** is a fundamental area of number theory. It deals with the number of ways that a whole number can be partitioned into whole number parts.

Number - 5 for example can be partitioned in 7 ways thus,

11111, 2111, 221, 311, 32, 41, 5

**19** can be partitioned in 490 ways.

**19** can be Partitioned 10 times with each term no larger than 2

**19** can be Partitioned 40 times with each term no larger than 3

**19** can be Partitioned 94 times with each term no larger than 4

**19** can be Partitioned 164 times with each term no larger than 5

**19** can be Partitioned 235 times with each term no larger than 6.

**19** can be Partitioned 300 times with each term no larger than 7

**19** can be Partitioned 352 times with each term no larger than 8.

**19** can be Partitioned 393 times with each term no larger than 9.

**19** can be Partitioned 423 times with each term no larger than 10.

**19** can be Partitioned 445 times with each term no larger than 11.

**19** can be Partitioned 460 times with each term no larger than 12.

**19** can be Partitioned 471 times with each term no larger than 13.

**19** can be Partitioned 478 times with each term no larger than 14.

**19** can be Partitioned 483 times with each term no larger than 15.

**19** can be Partitioned 486 times with each term no larger than 16.

**19** can be Partitioned 488 times with each term no larger than 17.

**19** can be Partitioned 489 times with each term no larger than 18.

## The Golden Ratio and 19

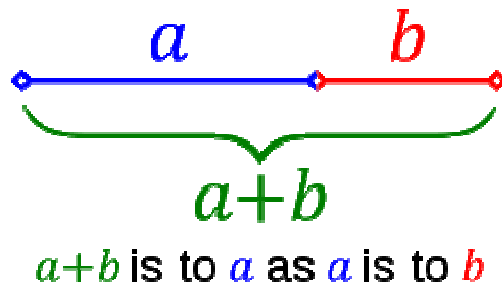


“Some of the greatest mathematical minds of all ages, from Pythagoras and Euclid in ancient Greece, through the medieval Italian mathematician Leonardo of Pisa and the Renaissance astronomer Johannes Kepler, to present-day scientific figures such as Oxford physicist Roger Penrose, have spent endless hours over this simple ratio and its properties. But the fascination with the Golden Ratio is not confined just to mathematicians. Biologists, artists, musicians, historians, architects, psychologists, and even mystics have pondered and debated the basis of its ubiquity and appeal. In fact, it is probably fair to say that the Golden Ratio has inspired thinkers of all disciplines like no other number in the history of mathematics.”

Mario Livio

In mathematics, arts, life and in all the Universe, the two quantities are in the golden ratio if the ratio of the sum of the quantities to the larger quantity is equal to the ratio of the larger quantity to the smaller one.

The golden ratio is a mathematical constant, approximately 1.6180339887. The other names used for the golden ratio are the golden section and golden mean. Other terms encountered include extreme and mean ratio, medial section, divine proportion, divine section, golden proportion, golden cut, golden number, and mean of Phidias. The golden ratio is often denoted by the Greek letter phi, usually lower case ( $\phi$ ).



The figure on the right illustrates the geometric relationship that defines this constant. Expressed algebraically:

$$\frac{a+b}{a} = \frac{a}{b} \equiv \varphi.$$

This equation has one positive solution in the algebraic number

$$\varphi = \frac{1 + \sqrt{5}}{2} \approx 1.6180339887\dots$$

“What do the pyramids in Egypt, Leonardo da Vinci's portrait of the Mona Lisa, sunflowers, the snail, the pine cone and your fingers all have in common?

The answer to this question lies hidden in a sequence of numbers discovered by the Italian mathematician Fibonacci. The characteristic of these numbers, known as the Fibonacci numbers, is that each one consists of the sum of the two numbers before it.”

(Guy Murchie, *The Seven Mysteries of Life*, First Mariner Books, New York, pp. 58-59)

## **Fibonacci numbers**

**0, 1, 1, 2, 3, 5, 8, 13, 21, 34, 55, 89, 144, 233, 377, 610, 987, 1597, 2584, ...**

Fibonacci numbers have an interesting property. When you divide one number in the sequence by the number before it, you obtain numbers very close to one another. In fact, this number is fixed after the 13th in the series. This number is known as the "golden ratio."

## **Golden Ratio = 1.618**

$$233 / 144 = 1.618$$

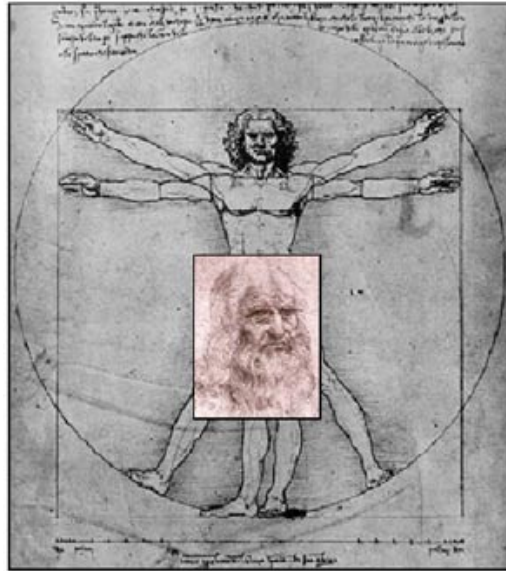
$$377 / 233 = 1.618$$

$$610 / 377 = 1.618$$

$$987 / 610 = 1.618$$

$$1597 / 987 = 1.618$$

$$2584 / 1597 = 1.618$$



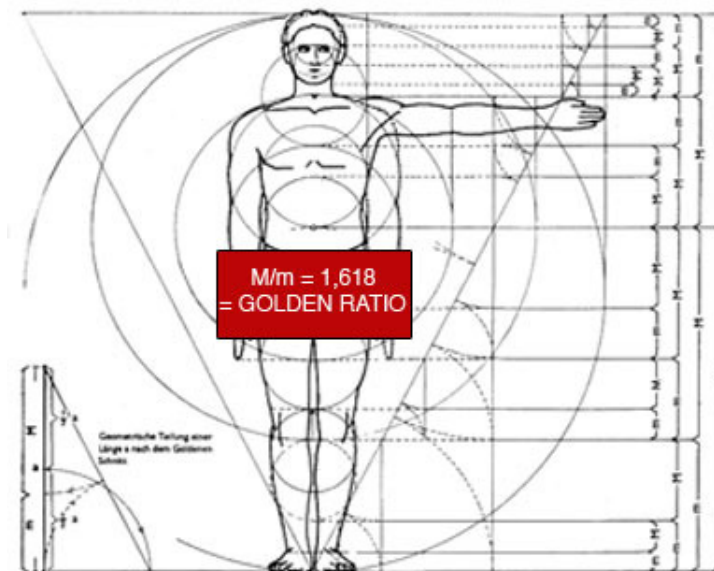
Leonardo da Vinci used the golden ratio in setting out the proportions of the human body.

### Golden Ratio and the Human Body:

“The "ideal" proportional relations that are suggested as existing among various parts of the average human body and that approximately meet the golden ratio values can be set out in a general plan as follows:

The  $M/m$  level in the table below is always equivalent to the golden ratio.  $M/m = 1.618$ ”

(J. Cumming, Nucleus: Architecture and Building Construction, Longman, 1985)





The example of the golden ratio in the average human body is that when the distance between the navel and the foot is taken as 1 unit, the height of a human being is equivalent to 1.618. Some other golden proportions in the average human body are:

- The distance between the finger tip and the elbow / distance between the wrist and the elbow.
- The distance between the shoulder line and the top of the head / head length.
- The distance between the navel and the top of the head / the distance between the shoulder line and the top of the head.
- The distance between the navel and knee / distance between the knee and the end of the foot.

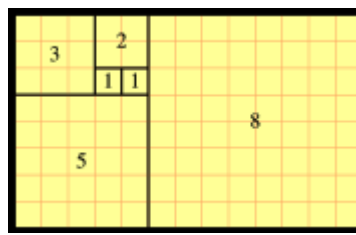
## Golden Ratio – Everywhere in our life and Universe:

In the universe there are many spiral galaxies containing the golden ratio in their structures. The molecule in which all the physical features of living things are stored, too, has been created in a form based on the golden ratio. The golden ratio also manifests itself in crystal structures. You will encounter Fibonacci series and the golden ratio in fields that fall under the sphere of physics. Three-dimensional forms that contain the golden ratio are very widespread in micro-organisms.

**"My Lord encompasses all things in His knowledge so will you not pay heed?"**

(Sura al-An'am, 80)

What is even more interesting is that we can create a Golden Rectangle from Fibonacci Numbers too. Just square each Fibonacci Number



The above illustrated example of how Fibonacci Numbers are directly & intricately related to the Golden Ratio. In this case, the Golden Rectangle.

## Golden Ratio, Fibonacci Numbers and 19:

Is there a common factor in the Fibonacci Sequence? It was discovered in the 1960's that the Periodic Table of Elements - building blocks of everything are numerically structured based on the number "19". The Golden Ratio & Fibonacci Numbers relates to growth and creation of life and physical structures in our universe. In other words, the elements are the building blocks of all things and the Golden Ratio/Fibonacci Numbers is HOW these blocks come together. So, if the Periodic Table of Elements is governed by 19. Why wouldn't the Fibonacci sequence be too.

The 19<sup>th</sup> Number in the Fibonacci series is 2584

### 19<sup>th</sup> Fibonacci Number = 2584

If we add all the numbers in the Number – 2584, the resulting number would be 19.

$$2584----- 2 + 5 + 8 + 4 = 19$$

Also  $19 \times 136 = 2584$

$$19 \times 136 = 2584$$

Also:

*There are 19 different Fibonacci numbers below 10,000.*

The following tables are the research work taken as a courtesy from ([people.hws.edu/ahmed/fibonacci.pdf](http://people.hws.edu/ahmed/fibonacci.pdf)) to show the amazing results of Number - 19

Now we see the amazing relationship between Fibonacci sequence of numbers and Number – 19 in the following tables:

Only these Fibonacci Numbers are completely divided by Number - 19

**Table – 1:**

Order in Fibonacci Series	Fibonacci Numbers	Divide by 19 results
19 <sup>th</sup>	2584	136.00
37 <sup>th</sup>	14930352	785808.00
55 <sup>th</sup>	86267571272	4540398.00
73 <sup>rd</sup>	498454011879264	26234421677856.00

The Number – 19 is not the common denominator of all the Fibonacci series of numbers. However the 19<sup>th</sup>, 37<sup>th</sup>, 55<sup>th</sup> and 73<sup>rd</sup> Fibonacci sequence are divisible by Number – 19

The first Fibonacci number completely divided by 19 is 2584. Now we see the relationship of the Fibonacci numbers with Number – 19 in the given tables:

**Table – 2:**

Order	Fibonacci No.			Result	Divide by 19
1	0	ADD	2584	2584	136.0
2	1	SUBTRACT	1597	- 1596	-84.0
3	1	ADD	987	988	52.0
4	2	SUBTRACT	610	-608	-32.0
5	3	ADD	377	380	20.0
6	5	SUBTRACT	233	-228	-12.0
7	8	ADD	144	152	8.0
8	13	SUBTRACT	89	-76	-4.0
9	21	ADD	55	76	4.0
10	34	SUBTRACT	34	0	0.0
11	55	ADD	21	76	4.0
12	89	SUBTRACT	13	76	4.0
13	144	ADD	8	152	8.0
14	233	SUBTRACT	5	228	12.0
15	377	ADD	3	380	20.0
16	610	SUBTRACT	2	608	32.0
17	987	ADD	1	988	52.0
18	1597	SUBTRACT	1	1596	84.0
19	2584	ADD	0	2584	136.0

The numbers needed to make them divisible by 19, in fact, turned out to be the Fibonacci numbers in **reverse** (or flipped). It is the same phenomena as with the Golden Ratio in living organisms. It had to be flipped. It was only 19 that factored ALL results across the board. If you try this “Fibonacci Flip” formula with the first 16, 18, 17, 20 sequences etc instead of the 19th sequence, they would not divide evenly by 19.

It had to be the **first 19 Fibonacci numbers** flipped for a common denominator (factor) to be found, and it happened to be the number 19. It is remarkable because the Fibonacci Sequence is generated by added each new number in the series to the number before it. They are all sums. They are not multiples of anything, yet we still find a common denominator.

Now we see what would happen if we continued the sequence in Table - 3. Would it still be divisible by 19?

**Table – 3:**

Order	Fibonacci No.		Flipped Fibonacci No.	Result	Divide by 19
1	0	ADD	2584	2584	136.0
2	1	SUBTRACT	1597	- 1596	-84.0
3	1	ADD	987	988	52.0
4	2	SUBTRACT	610	-608	-32.0
5	3	ADD	377	380	20.0
6	5	SUBTRACT	233	-228	-12.0
7	8	ADD	144	152	8.0
8	13	SUBTRACT	89	-76	-4.0
9	21	ADD	55	76	4.0
10	34	SUBTRACT	34	0	0.0
11	55	ADD	21	76	4.0
12	89	SUBTRACT	13	76	4.0
13	144	ADD	8	152	8.0
14	233	SUBTRACT	5	228	12.0
15	377	ADD	3	380	20.0
16	610	SUBTRACT	2	608	32.0
17	987	ADD	1	988	52.0
18	1597	SUBTRACT	1	1596	84.0
19	2584	ADD	0	2584	136.0
20	4181	SUBTRACT	1	4180	220.0
21	6765	SUBTRACT	1	6764	356.0
22	10946	SUBTRACT	2	10944	576.0
23	17711	SUBTRACT	3	17708	932.0

The formula still works. However, it is interesting to note that after the 19th Fibonacci sequence the calculation is always “subtract”. Which makes sense as the sequence started up again on at the 19<sup>th</sup> sequence. Now, let’s see how far these numbers go.....

**Table – 4:**

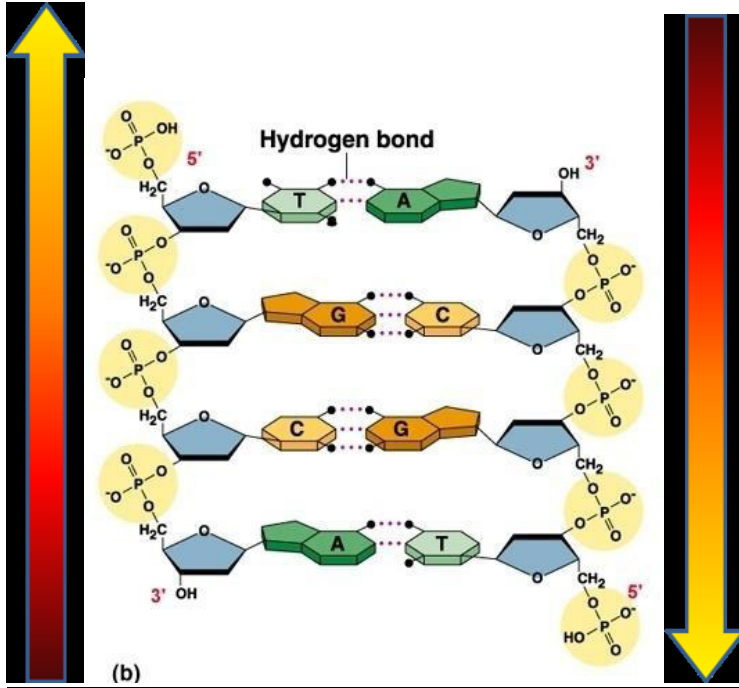
Fibonacci No.		Flipped Fibonacci Numbers	Result	Divide by 19
0	ADD	2584	2584	136.0
1	SUBTRACT	1597	- 1596	-84.0
1	ADD	987	988	52.0
2	SUBTRACT	610	-608	-32.0
3	ADD	377	380	20.0
5	SUBTRACT	233	-228	-12.0
8	ADD	144	152	8.0
13	SUBTRACT	89	-76	-4.0
21	ADD	55	76	4.0

34	SUBTRACT	34	0	0.0
55	ADD	21	76	4.0
89	SUBTRACT	13	76	4.0
144	ADD	8	152	8.0
233	SUBTRACT	5	228	12.0
377	ADD	3	380	20.0
610	SUBTRACT	2	608	32.0
987	ADD	1	988	52.0
1597	SUBTRACT	1	1596	84.0
<b>2584</b>	<b>ADD</b>	<b>0</b>	<b>2584</b>	<b>136.0</b>
4181	SUBTRACT	1	4180	220.0
6765	SUBTRACT	1	6764	356.0
10946	SUBTRACT	2	10944	576.0
17711	SUBTRACT	3	17708	932.0
28657	SUBTRACT	5	28652	1508.0
46368	SUBTRACT	8	46360	2440.0
75025	SUBTRACT	13	75012	3948.0
121393	SUBTRACT	21	121372	6388.0
196418	SUBTRACT	34	196384	10336.0
317811	SUBTRACT	55	317756	16724.0
514229	SUBTRACT	89	514140	27060.0
832040	SUBTRACT	144	831896	43784.0
1346269	SUBTRACT	233	1346036	70844.0
2178309	SUBTRACT	377	2177932	114628.0
3524578	SUBTRACT	610	3523968	185472.0
5702887	SUBTRACT	987	5701900	300100.0
9227465	SUBTRACT	1597	9225868	485572.0
<b>14930352</b>	<b>SUBTRACT</b>	<b>2584</b>	<b>14927768</b>	<b>785672.0</b>
24157817	SUBTRACT	4181	24153636	1271244.0
39088169	SUBTRACT	6765	39081404	2056916.0

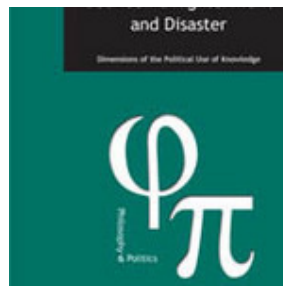
### Conclusion from the above tables:

- As we can see, every single number in the above table is perfectly divisible by 19.
- Fibonacci Numbers & Golden Ratio are directly related to each other and the physical universe and the Fibonacci Numbers are also directly related to Number – 19.
- When Fibonacci “Flip” formula applied **ALL** results divisible across the board specifically by number **19** on the same principle when we have to observe the **Golden ratio in living organisms on opposite sides of their bodies, we have to reverse or “Flip” the Golden Ruler i.e. backside to bellyside.**

The building blocks of life - DNA. A perfect “Copy / Flip” phenomena:



Pi and Phi:



$\phi(19) - \pi(19) = 1 + 9$ . 19 is the only prime with this property

- Golden Ratio = 1.618..... The Numbers in the Golden Ratio can be added as:

$$1.618..... 1 + 618 = 619$$

619.....114<sup>th</sup> Prime Number

$$6 \times 19 = 114$$

## Perfect Sphere and 19



“Nothing has afforded me so convincing a proof of the unity of the Deity as these purely mental conceptions of numerical and mathematical science which have been by slow degrees vouchsafed to man, and are still granted in these latter times by the Differential Calculus, now superseded by the Higher Algebra, all of which must have existed in that sublimely omniscient Mind from eternity.”

**Mary Somerville**

When we observe the universe, we realize that all the heavenly and celestial bodies are spheres. So question raises in our minds why our God has created all His heavenly bodies like Sun, moons, stars, earth, etc only in the shape of spheres and not in any other shape?



*The eight planets and three dwarf planets of the Solar System*

One cannot see pentagons or triangles or rectangles or squares as a heavenly body in our universe. Only sphere is the shape chosen by our creator. So there should be a secret in spheres.

**I call the Universe as: Perfect Spherical Expanding Universe**

When sphere is the only representative of the heavenly creations of God, then its standard or perfection should exist.

When we manufacture or produce anything in our world as humans, we make a certain standard or model or symbol of perfection for that thing and compare the rest of the manufactured and produced things with that standard and that is called '**Standardization**' and '**Certification**' of the manufactured items. We send our manufactured items to the laboratories to gauge and measure them with the standards we accepted as perfect standards for those items.

**“It’s more like exploring underwater. You’re in the mud, and everything looks the same.”**

**Gregory Chudnovsky**

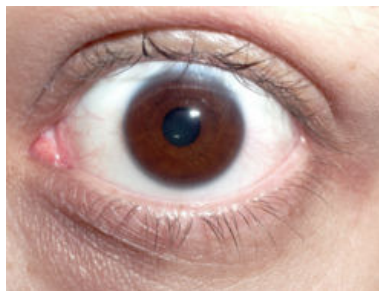


*Spherical Earth – our living planet*

As humans we know standardization and perfection, so do we think that our God is ignorant about 'Standardization' and 'Perfection'. When our Creator created all the heavenly bodies as spheres, so there should a "Perfect Sphere" who would act as a "Standard" and "Perfection" for the other created spheres. That is why the ratio of the circumference and the diameter of that "Perfect Sphere" would be a constant in all the spheres of the universe.

The Perfect Sphere should exist in our universe as a standard for all the other universal spheres and celestial spheres and that's why pi is a god's riddle till today.

The Creator of our Universe also created our human body on the same principle. The representative of 'Sphere and Circle' in our body is the 'Human Eye'.



*This image shows the pupil and iris of the human eye.*



Human eye is spherical in shape and the ‘Pupil and the Iris’ – a circular colored spot visible in front of our eyes, usually black or brown is circle in shape. So God has given us two ‘Spherical Eyes’ with a ‘Pupil and Iris’ encircling in the middle and front of eye to see all the spheres of the universe including all circles and cycles in human life and science.

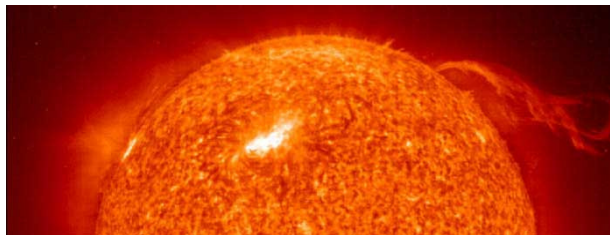
Eyes in the human body are the representatives of ‘spheres’ in our world. Eyes are one of the most important organs of human body. We cannot enjoy our lives without eyes. We cannot ignore eyes in the study of medicine. Eyes also represent the feelings of a person. The creator of our Universe has well placed the ‘spherical eye’ in our human body and we all know the importance of eye in their bodies.

## Perfection and Perfect Attributes

One of the attributes of Perfection, I believe and define is that:

**Perfection can only be calculated or measured with its ‘Perfect Attributes’. Perfect attributes of Perfection can only be discovered or found out if searched correctly. We can judge the ‘Perfect Attributes’ of Perfection by applying their values to other constants and formulae to verify their Perfection.**

We can calculate and measure ‘Perfection’ by putting its ‘Perfect Attributes’ into different formulas, constants, formulae, numbers and into different practical and theoretical examinations and can judge its perfection. We can know and understand ‘Perfection’ by seeing its role in our universe and day to day lives. So if know the ‘Perfect Sphere’ in our universe, we have to know its ‘Perfect and Constant Attributes’ i.e. ‘Perfect and Rational Circumference, Diameter, Radius, Pi, Degrees, Surface Area, and Volume.’



*Spherical Sun*

For example Gold has to be discovered and found first from the Gold mines, then we can calculate and measure the amount and the quality of Gold in that mine. We cannot start measuring Gold first and then discovering it. We have to follow a logical and rational path. First discover it and then found its attributes. But if we make a law that Gold does not exist in the first place, and then we did not even bother to search it in any Gold mine to find the natural Gold. Instead we make artificial and synthetic Gold and sell in the market saying that as natural Gold does not exist and we can make synthetic and artificial Gold which is very near to the Natural Gold, so please buy this Gold.

This is what happened with the concept of “**Perfect Sphere and Perfect Circle**”. We made a law and conviction that as no ‘Perfect Sphere or Perfect Circle’ exists, so we have to make artificial and synthetic circles and then calculate its attributes like Pi and we had to go through all the cumbersome process of calculating, estimating and approximating the value of Pi in the last 4000 years and are seeing the fruits of our efforts as irrational and abnormal Pi instead of finding a rational and normal Pi from the “Perfect Sphere and Perfect Circle”.



*The terrestrial planets: Mercury, Venus, Earth, Mars*

If had concentrated our efforts in finding a ‘Perfect Sphere’ or a ‘Perfect Circle’ in our science or Universe, then we could have saved much effort and time of our scientists and mathematicians in our history of calculating Pi.

So that is the basis of my research of “Perfect Sphere” whose one of the big attributes is a “Rational and Real Pi” whose constant perfect number represents the “Perfection” of our Perfect Spherical Expanding Universe and One and Only Almighty Perfect God.

I never tried to calculate and estimate Pi. I rather searched a ‘Perfect Sphere’ in our Perfect Spherical Universe. Finally I discovered and found it in our universe and nature. When I discovered the ‘Perfect Sphere’, I draw many conclusions and results. The most important of them are:

- There should be One and Only Perfect Almighty God of our universe, as there are only Celestial Spheres in our universe and no other shape of a heavenly body. If two or more Gods ever existed, then they should have created something in the Universe different from the ‘Celestial Spheres’ like Celestial Pentagons, Celestial Squares, Celestial Triangles, etc. to distinguish themselves from one another by creating different shapes of creations especially heavenly bodies. But the presence of only ‘Celestial Spheres’ as heavenly bodies of our Universe is showing the Presence of Only One Perfect Almighty God and no other God.
- Secondly, it shows that our Universe is not the result of an accident. This is not an accidental or incidental Universe because if it is the result of an accident, then some heavenly bodies should be Celestial Triangles, some should be Celestial Rectangles, some should be Celestial Cubes and some should be of other irregular shaped bodies. But

only the presence of ‘Celestial Spheres’ proves that this Universe is a ‘Perfect Universe’ created by One and Only Almighty God in a Perfect shape i.e. ‘Spheres’. So this universe should show perfection of Creator and the Created and show the organized planning and creation of its Planner and Creator

- Thirdly, with the presence of a “Perfect Sphere”, we can calculate its most important attribute, i.e. ‘Perfect and Rational Pi’. So I calculated the value of ‘Rational and Perfect Pi’ and sharing it with the mankind now. All the other attributes and findings like squaring the circle, rectification of the circle, etc are also proved with the discovery of ‘Perfect Sphere’.



*Spherical Saturn*

Once we know the ‘Perfect Sphere’, we can calculate and measure as many Universal constants and formulae based on pi to the degree of ‘Perfection’

That is why the discovery of ‘Perfect Sphere’ is a remarkable discovery of all times and on the basis of the finding of ‘Perfect Sphere’, we can calculate, ‘Perfect and Rational Pi’ – which is the symbol of our universe.

## **Perfection and Modeling:**

**“The circle is one of the noblest representations of Deity, in his noble works of human nature. It bounds, determines, governs and dictates space, bounds latitude and longitude, refers to the sun, moon, and all the planets in direction, brings to the mind thoughts of eternity, and concentrates the mind to imagine for itself the distance and space it comprehends. It reflects all boundaries; it is the key to information of the knowledge of God.”**

*John Davis – The Measure of the Circle, 1854*

We are living in an age of ‘Modeling’ and ‘Perfection.’ We see lot of fashion models setting fashion standards for our young and modern generation – boys and girls on media and shows. We make models for our lives, whether they belong to film or sports or religion or politics, etc. We follow models because we see ‘Perfection’ in them in some areas which we want to excel.

Perfection is the requirement for a Model, who wants to be followed. As humans we are in search of models and perfection. So do we think that our God while making His Spherical Creations – heavenly bodies as Stars, moons, planets did not consider ‘Perfection?’ We cannot imagine assuming that ‘Perfection’ would not be in His mind when our God was creating this Spherical Universe and still more and more Spherical Stars are born every day in our Universe.

In an industrial world, all the industries and factories make some models for their products and the rest of the production of the items or goods are solely based on the ‘Perfect model’ they made for their industrial goods. For instance, the car manufacturers make some models for the production of rest of the cars of that model. Pharmaceutical industry makes model specimens for the medicine to be marketed later on. Construction industry makes architectural models for the construction projects whether it is a building, or a bridge or a highway. So we see that all the industries in our world follow the same rule of making a ‘**Perfect Model**’ of their production and keeping that model as a standard for the rest of their goods, whether the goods would fulfill the requirements of a ‘Perfect Model’ or not, that is a separate issue. But for standardization and perfection, the presence of a ‘Perfect Model’ should have to be there.

So ‘**Perfect Model**’ of a ‘**Perfect Sphere**’ should be the answer to this question. There should be a ‘Perfect Model’ of a ‘Perfect Sphere’ as a standard and reference for all the Spheres in our Universe like Sun, moon, earth, etc. The ‘Perfect Ratio’ of circumference and the diameter of that ‘Perfect Sphere’ is called the ‘Perfect Pi’. ‘Perfect Sphere is a Perfect Model for all the Spheres of our Universe, life, time, space, mathematics and sciences.

We are searching our numbers for the ‘Perfect Sphere’- Diameter and Circumference. So our search should start with the smallest and the Perfect Numbers in Mathematics. So what is the smallest and Perfect Number in Mathematics?

### **Number – 6 is the First and the Smallest Perfect Number in Mathematics:**

The mathematicians know that number – 6 is the first and the smallest ‘Perfect Number’ in mathematics.

The number would be called ‘Perfect Number’ in mathematics if the sum of the divisors of that number is equal to that Number.

The divisors of Number – 6 are: 1, 2 and 3. Their sum is:

$$1 + 2 + 3 = 6$$

Also amazingly, if multiply these 3 numbers, we would get the Number – 6 again:

$$1 \times 2 \times 3 = 6$$

$$1 + 2 + 3 = 6 = 1 \times 2 \times 3$$

## Perfect Cube:

In arithmetic and algebra, the **cube** of a number  $n$  is its third power — the result of the number multiplying by itself three times:

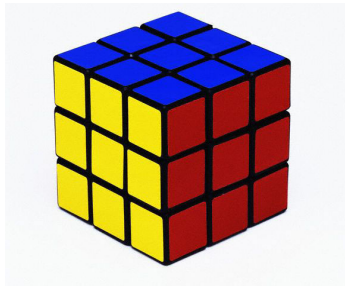
$$n^3 = n \times n \times n$$

In mathematics, a **perfect cube** (also called a **cube number**, or sometimes just a **cube**) is a number which is the cube of an integer.

The sequence of non-negative perfect cubes starts (sequence A000578 in OEIS):

0, 1, 8, 27, 64, 125, 216, 343, 512, 729, 1000, 1331, 1728, 2197, 2744, 3375, 4096, 4913, 5832, 6859, 8000, 9261, 10648, 12167, 13824, 15625, 17576, 19683, 21952, 24389, 27000, 29791, 32768, 35937, 39304, 42875, 46656, 50653, 54872, 59319, 64000, 68921, 74088, 79507, 85184, 91125, 97736, 103823, 110592, 117649, 125000, 132651, 140608, 148877, 157464, 166375, 175616, 185193, 195112, 205379, 216000, 226981, 238328...

(Reference: [http://en.wikipedia.org/wiki/Cube\\_\(algebra\)](http://en.wikipedia.org/wiki/Cube_(algebra)))



As we are discussing the Perfect Number – 6, so we would see the ‘Perfect Cube’ of Number – 6 and its relation with the ‘Perfect Sphere’.

### Relationship between Perfect Cube and Perfect Sphere:

Perfect Attributes of “Perfect Cube” of first and the smallest ‘Perfect Number’ in Mathematics – Number – 6.

**Length of the Perfect Cube = 6**

**Width of the Perfect Cube = 6**

**Height of the Perfect Cube = 6**

**Surface Area of the Perfect Cube = 6 x 6 x 6 = 216**

**Volume of the Perfect Cube = 6 x 6 x 6 = 216**

*The Perfect Cube of Number – 6 is the only ‘Perfect Cube’ whose surface area and the volume shows the same Number – 216 irrespective of their units.*

**Surface Area of the Perfect Cube of 6 = 216 = Volume of the Perfect Cube of 6**

It is the **only ‘Perfect Cube’ of Number – 6**, which shows this amazing result and it becomes a unique model for all other ‘Perfect Cubes’ in Mathematics as this cube has additional mathematical properties in addition to other ‘Perfect Cubes’.

As we are searching the ‘Perfect Attributes and Perfect Numbers’ for the Perfect Sphere, so let us see if any relationship exists between the ‘Perfect Cube’ of Number – 6 and the ‘Perfect Sphere’.

**Symbolic Relationship between Perfect Cube of 216 and Perfect Sphere:**

When all sides of a Perfect cube = 6

**Perfect Cube ----- 216**

**Perfect Cube of 6                      &                      Perfect Sphere of Diameter- ?**

**216 -----? (Searching for the Perfect Dimensions)**

*In Mathematics:*

**2 ----- 1<sup>st</sup> Prime Number ----- 1**

**1 ----- 1<sup>st</sup> Odd Number ----- 1**

**6 ----- 4<sup>th</sup> Even Number ----- 4**

**216 ----- 114**

So the mathematical position of the Numbers – 2, 1 and 6 are 1, 1 and 4. The Number – 216 is giving us a clue and indication of another Number – 114.

*The Number – 114 = 6 x 19*

**114 ---- 1 + 1 + 4 = 6.... First and Smallest Perfect Number in Mathematics**

## Cube of Number– 19 and its relationship with Number - 216

When all sides of the cube = 19

The Surface Area of the Cube of 19 =  $19 \times 6 \times 19 = 114 \times 6 = 2166$

In the above example of ‘Perfect Cube’ of Number – 6, the Surface Area and Volume of the Cube of 6 are 216. The Number 216 is:

**2 – 1- 6 ----- 1 – 1 - 4** (mathematical position of numbers 2, 1 and 6)

**2166..... 114 x 19**

**Surface Area of Cube of 19 .....2166..... 114 x 19**

**2166 ----- 114 x 19**

- Also, the Number – 216 is the 109<sup>th</sup> Even Number

**216.....109<sup>th</sup> Even Number**

**109.....Prime Number containing Numbers 1 and 9**

- If we add the numbers in Number – 216 as:

**216.....21 + 6 = 27**

**19.....8<sup>th</sup> Prime Number.....19 + 8 = 27**

## **Perfect Sphere and its Perfect Dimensions:**

Now we have to see whether we can have a 'Perfect Sphere' with the Numbers – 6 and 19 showing the same amazing results as 'Perfect Cube' of Number – 6 are showing.

Let us assume, the diameter of the 'Sphere' is 6 and the circumference is 19. What is the surface area and the volume of the sphere

$$\text{Diameter of the Sphere} = 6$$

$$\text{Circumference of the Sphere} = 19$$

$$\text{Surface Area of the Sphere} = 6 \times 19 = 114$$

$$\text{Volume of the Sphere} = 6 \times 19 = 114$$

$$\text{Surface Area of the Sphere} = 114 = 6 \times 19 = \text{Area of the Sphere}$$

This sphere is showing the same amazing results as we have seen with one and only 'Perfect Cube' of Number – 6, i.e. the number of the Surface Area is the same as that of Volume of the Sphere irrespective of the units of measurement.

Also:

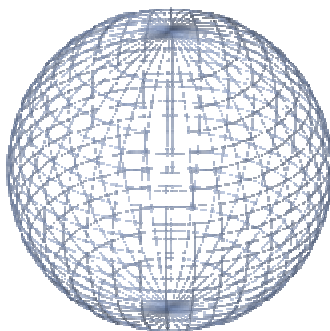
$$619 \dots \dots \dots 114^{\text{th}} \text{ Prime Number in Mathematics}$$

## **Perfect Sphere with Perfect Dimensions:**

On the same mathematical grounds, when we say that a 'Perfect Cube' of Number – 6 is a model for all the other 'Perfect Cubes' with the special and perfect results and numbers, we can say that mathematically we have found out the 'Perfect Sphere' showing the same perfect results and numbers with the following 'Perfect Dimensions'

- **Perfect Circumference of a Perfect sphere = 19**
- **Perfect Diameter of a perfect sphere = 6**





*Perfect Sphere*

**Mathematically, a sphere can be defined as:**

A **sphere** is a *perfectly symmetrical geometrical* object. This term is used in non-mathematical usage to refer either to a round ball or to its two-dimensional surface. In mathematics, a sphere is the set of all points in three-dimensional space ( $r^3$ ) which are at distance  $r$  from a fixed point of that space, where  $r$  is a positive real number called the *radius of the sphere*. The fixed point is called the **centre**, and is not part of the sphere itself. The special case of  $r = 1$  is called a **unit sphere**.

I define the '*Perfect Sphere*' as:

**Definition of a Perfect Sphere:**

*A Perfect Sphere is a solid circular sphere of 360 degrees having a perfect constant diameter of six (6), circumference of nineteen (19), its Surface area and the Volume should be equal to one hundred and fourteen (114) and the Perfect constant ratio of circumference to its diameter is 19/6.*

**Six – 6 - Perfect constant Dimensions and Attributes of a Perfect Sphere:**

1. Circumference = 19
2. Diameter = 6
3. Surface Area =  $19 \times 6 = 114$
4. Volume =  $19 \times 6 = 114$
5. Degrees =  $360^\circ = (19 - 1)^\circ \times (19 + 1)^\circ$
6. Pi ( $\pi$ ) =  $19/6$

## Perfect Sphere and Reflective Symmetry:



### *Perfect Hemisphere – Half of a Perfect Sphere*

The Perfect Sphere also fulfils the requirement of 'reflective symmetry' or line symmetry.

Reflective symmetry is in which a shape can be divided into two parts by a line or plane, such that each part of the shape is a mirror image of the other.

So if we divide a Perfect Sphere (having circumference of 19, diameter of 5, surface area of 114, volume of 114) into two (2) equal parts, the mathematical attributes of a Perfect Hemisphere would be:

**Surface Area of 1<sup>st</sup> Part = 57 = 19 x 3 = Surface Area of a Hemisphere**  
**Surface Area of 2<sup>nd</sup> part = 57 = 19 x 3 = Surface Area of a Hemisphere**

**Volume of 1<sup>st</sup> part = 57 = 19 x 3 = Volume of a Hemisphere**  
**Volume of 2<sup>nd</sup> part = 57 = 19 x 3 = Volume of a Hemisphere**

$$(19 \times 6) / 2 \quad \text{for 1st part} = 57$$
$$(19 \times 6) / 2 \quad \text{for 2nd part} = 57$$

All figures are showing symmetry in all dimensions.

**Area of 1<sup>st</sup> part = Volume of 1<sup>st</sup> part**

$$57 = 57 = 57 = 19 \times 3$$

Similarly for 2<sup>nd</sup> part, the same value for surface area and volume.

**Area of 2<sup>nd</sup> part = Volume of 2<sup>nd</sup> part**

$$57 = 57 = 57 = 19 \times 3$$

*Sphere is a Perfect Solid shape in all the geometrical solid shapes.*

## Super Cycle and 19



### Cycles in our World:

We observe different cycles in different fields of life in our world. The few examples of different cycles in different fields of life are:

- History Cycles
- Sports Cycles
- Arts Cycles
- Culture and Literature Cycles
- Science Cycles
- Astronomy Cycles
- Biology and Medical cycles
- Agriculture cycle
- Chemistry cycles
- Physics cycles
- Geology cycles
- Meteorology cycles
- Engineering cycles
- Mathematics cycles
- Computer science cycles
- Political science cycle
- Business Cycles
- Economics cycle
- Social Cycles
- Crime cycles
- Poverty cycle
- War Cycle

The cycles are circular in nature and everything comes to start, when it completes and finishes the cycle. So **0 degrees** is the start in the circle or cycle and **360 degrees** is the end of the cycle or circle.

## 19 x 19 = Super cycle

- $19 \times 19 = 361 = (360 + 1)$
- **360 degrees** = Total degrees in a complete circle =  $360^\circ = (19 - 1)^\circ \times (19 + 1)^\circ$

$$360^\circ = (19 - 1)^\circ \times (19 + 1)^\circ$$

If we add all the numbers in 361 and 360, we see:

$$361 - 360 \text{-----} 3 + 6 + 1 + 3 + 6 + 0 = 19$$

### Analysis of 360 and 361

$$360 = 6 \times 6 \times 10 = (19 - 1) \times (19 + 1)$$

$$361 = 19 \times 19 \times 01 = (6 + 6 + 6 + 1) \times (6 + 6 + 6 + 1)$$

If we look closely at the Numbers **360 (6 x 6 x10)** and **361 (19 x 19 x 01)**, we notice that the first two numbers – 3 and 6 are the same in both the Numbers. The only difference is 0 and 1.

$$360 \text{-----} 36 \mathbf{0}$$

$$361 \text{-----} 36 \mathbf{1}$$

**0 and 1 are the two different Numbers in 360 and 361.**

Where:

**0** – Zero is basically ‘Circle’ in shape and represents the ‘Circumference’ of a Circle.

**1** – One is basically ‘Line’ in shape and represents the ‘Diameter’ of a Circle.

If we analyze further, we see that Zero – 0 degrees in a complete circle is at the same position as 360 degrees. So the position of 0 degrees and 360 degrees is the same.

So we can say that:

**0 Degrees = 360 degrees ----- according to their position in the complete circle**

**Now the position of 360 degrees = is at 0 degrees .....A**

And 361 degrees = 360 degrees + 1 degree

361 degrees = 0 degrees (as per equation- A) + 1 degree

**361 degrees = (0 + 1) degree, as 0 degrees is at the position of 360 degrees.....B**

$$360 = 0 \text{ degree}$$

$$361 = 0 + 1 \text{ degree}$$

### **Another way to look at 361 and 360:**

There are so many ways to look and analyze these two magical numbers. Now if we add both the numbers separately and take their root numerical value and then put the root numbers in order to see what would be the resulting number.

$$361 = 3 + 6 + 1 = 10 = 1 + 0 = 1$$

$$360 = 3 + 6 = 9$$

Now **361 = 1** and **360 = 9**

$$361 - 360 \text{ ----- } 1 - 9 \text{ or } 19$$

$$\text{Also } 19 \times 19 = 361 = [(3 \times 6) + 1] \times [(3 \times 6) + 1]$$

If we put 361 and 360 as a single number, we may write:

$$361 - 360 \text{ as } 361360 \text{ or } 19 \text{..... } 3 + 6 + 1 + 3 + 6 + 0 = 19$$

So the resulting number would be **19**, which is the 'Constant Circumference of a Perfect Sphere or a Perfect Circle'.

## **Formation of All New Cycles by Nineteen – 19 and Six – 6:**

**19 x 19 is the Super Cycle**, which not only completes the cycle but also generates or creates another cycle of the same nature and characteristics. How?

*Number – Nineteen – 19 is the ‘Mother of all new perfect cycles’.*

### **Mathematical Proof:**

Multiply 19 with 19 degrees, we get (360 +1) degrees. If we start rotating around the cycle with (19 x 19 degrees) at 0 degrees and take 1 rotation, we would finish at (360 + 1) degrees, i.e., one complete cycle of 360 degrees plus 1 degree. Now take another rotation starting from 1<sup>st</sup> degree, we will complete the rotation of (19 x 19) at 2<sup>nd</sup> degree and now keep on rotating like that way.

When we complete 360 rotations, a new cycle would generate and the super cycle of (19 x 19 degrees) would finish at 360 degrees after completing 360 rotations or you can say at 0 degrees, because it will complete the cycle of 360 rotations and come to an end from where it has started the cycle.

#### **1<sup>st</sup> Rotation of (19 x 19 degrees) ---- Super Cycle**

19 x 19 degrees = 360 + 1 degree

2<sup>nd</sup> Rotation starting at 1<sup>st</sup> degree, where the 1<sup>st</sup> rotation ends

2<sup>nd</sup> Rotation of (19 x 19 degrees) = 361 would finish at 2<sup>nd</sup> degree.

So keep on rotating in this manner and take 360 rotations with the Super cycle of 19 x 19 = 361 degrees, we would complete the circle at 360<sup>th</sup> rotation and a new circle would born of 360 degrees at the last 360<sup>th</sup> rotation.

#### **360 Rotations of (19 x 19 degrees) Super Cycle ----- New Cycle would create**

*A New Cycle of 360 degrees would generate or create from 360 rotations of Super Cycle i.e. 19 x 19*

$$\text{Super Cycle} = 19 \times 19 = 361 = (360 + 1) \text{ Degrees}$$

$$(361 - \text{Super Cycle}) \times (360 - \text{Rotations}) = (1 \text{ New Cycle} \times 360 \text{ Degrees}) + (360 \text{ Cycles} \times 360 \text{ Degrees}) \dots \dots \dots ?$$

$$[(19 \times 19 \times 01)] \times [6 \times 6 \times 10] = (1 \text{ new cycle} \times 360 \text{ Degrees}) + (360 \text{ cycles} \times 360 \text{ Degrees})$$

$$[(19 \times 19) \times (6 \times 6)] \times (01 \times 10) = (1 \text{ new cycle} \times 360 \text{ Degrees}) + (360 \text{ cycles} \times 360 \text{ Degrees})$$

$$[(19 \times 6) \times (19 \times 6)] \times (01 \times 10) = (1 \text{ new cycle} \times 360 \text{ Degrees}) + (360 \text{ cycles} \times 360 \text{ Degrees})$$

$$(114 \times 114) \times (01 \times 10) = (1 \text{ new cycle} \times 360 \text{ Degrees}) + (360 \text{ cycles} \times 360 \text{ Degrees})$$

*1 new cycle of 360° is created by 360 rotations of the Super Cycle – 19 x 19*

*19 x 19 is considered as the super cycle and ‘Mother of all New Perfect Circles’.*

**Conclusion:**

So a new cycle of 360 degrees is created and the original cycle completes its rotation at 360 degrees after 360 rotations of the Super Cycle i.e. 19 x 19. So without any change in the original cycle of 360 degrees, a new and complete cycle of 360 degrees is created

## Perfect Pi ( $\pi$ ) and 19



### Most Famous and Mysterious Mathematical Constant - Pi – $\pi$ A God's riddle:

$\pi$

- Most Famous Ratio in the History of Mankind

**“Probably no symbol in mathematics has evoked as much mystery, romanticism, misconception and human interest as the number pi.”**

*William L. Schaaf – Nature and History of Pi*

Pi is the most famous and the most mysterious ratio in mathematics and most renowned mathematical unsolved number in our world. It is also one of the most ancient numbers known to humanity.

By definition, **Pi is the ratio of the circumference of a circle to its diameter.** That means ‘how much bigger is the circumference as compared to the diameter of a circle.’ Pi is always the same number, no matter which circle you use to compute it.

“Pi –3.1415926535897932384626433832795028841971...1.24 trillion dps.”

In the book, ‘Introduction to Pi’, L.Berggren, J.Borwein and P.Borwein describe pi as:

“The story of pi reflects the most seminal, the most serious and sometimes the silliest aspects of mathematics. A surprising amount of the most important mathematicians and a significant number of the most important mathematicians have contributed to its unfolding – directly or otherwise.



Pi is one of the few concepts in mathematics whose mention evokes a response of recognition and interest in those not concerned professionally with the subject. It has been a part of human culture and the educated imagination for more than twenty five hundred years.”

Chris Witcombe from Sweet Briar College writes in his article on Pi as:

“Pi, which is denoted by the Greek letter  $\pi$ , is the most famous ratio in mathematics, and is one of the most ancient numbers known to humanity. Pi has had various names through the ages, and all of them are either words or abstract symbols, since pi is a number that can’t be shown completely and exactly in any finite form of representation. Pi is a transcendental number. A transcendental number is a number but can’t be expressed in any finite form of either arithmetical or algebraic operations. Pi slips away from all rational methods to locate it. It is indescribable and can’t be found. Ferdinand Lindermann, a German mathematician, proved the transcendence of pi in 1882. Pi possibly first entered human consciousness in Egypt.”

We know that the Egyptians and the Babylonians knew about the existence of the constant ratio pi, although they approximated and estimated its value as we do today. They had figured out that it was a little bigger than 3. The constant is named pi because it is the first letter of the Greek words, “Peripherea or periphery in English.

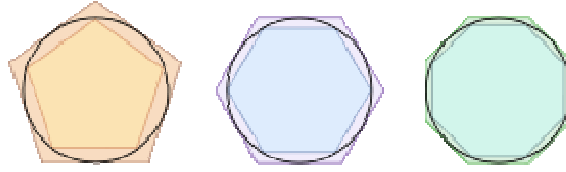
One of the oldest surviving mathematical writing is the Rhind Papyrus, named after the Scottish Egyptologist A Henry Rhind who purchased it in Luxor in 1858. It is a scroll nearly about 6 meters long and 1/3 of a meter wide and was written around 1650 BC by the scribe Ahmes who copied a document which is 200 years older. This gives date for the original papyrus of about 1850 BC but some experts believe that Rhind Papyrus is based on the work going back to 3400 BC. So the earliest known reference to pi occurs in a Middle Kingdom papyrus scroll.

Chris Witcombe described the history of pi as:

“Ahmes began scroll with the words: *“The Entrance into the Knowledge of All Existing Things”* and remarks in passing that he composed the scroll ‘in likeness to writings made of old.’ Towards the end of the scroll, which is composed of various mathematical problems and their solutions, the area of a circle is found using a rough sort of pi.”

In the Rhind Papyrus, Ahmes gives a rule to construct a square of area nearly equal to that of a circle. The rule is to cut 1/9 off the circle’s diameter and to construct a square on the remainder. It shows that the problem of constructing a square of area equal to that of a circle goes back to the beginning of the mathematics. This is quite a good approximation, corresponding to a value of 3.1605, rather than 3.14159 for pi.

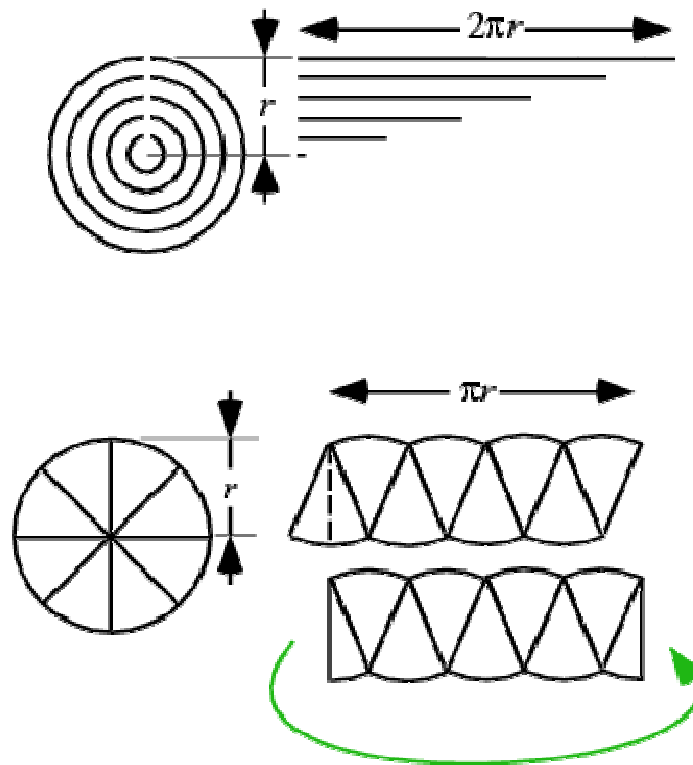
The Babylonians had an approximation of 3.125 and the Egyptians had an estimation of 3.160484. Around 200 BCE, Archimedes of Syracuse, one of the greatest mathematicians of the ancient world, approximated that pi is somewhere about 3.14 in fractions because Greeks did not have decimals. Archimedes was the first to give a scientific method for calculating pi to arbitrary accuracy.



## Principle of Archimedes' method to approximate $\pi$ :

Archimedes of Syracuse discovered, by considering the perimeters of 96-sided polygons inscribing a circle. When a circle's diameter is 1, its circumference is  $\pi$ .

He estimated the area of a circle by using the Pythagorean Theorem to find the areas of two regular polygons: the polygon inscribed within the circle and the polygon within which the circle was circumscribed. Since the actual area of the circle lies between the areas of the inscribed and circumscribed polygons, the areas of the polygons gave upper and lower bounds for the area of the circle. Archimedes knew that he had not found the value of pi but only an approximation within those limits.



A little known verse of the Bible reads and mentions about Pi:

**“And he made a molten sea, ten cubits from the one brim to the other: it was round all about and his height was five cubits: and a line of thirty cubits did compass it about.” (I Kings 7, 23)**

And it gives the value of Pi equal to 3. Rabbi Nehemiah explained this in his '**Mishnat ha - Middot**' (the earliest known Hebrew text on geometry, 150 AD) by saying that the diameter was measured from the outside of the brim while the circumference was measured along the inner rim. The stated dimensions would be exact if measured this way on a brim about four inches wide.

This is disputed, however, and other explanations have been offered, including that the measurements are given in round numbers (as the Hebrews tended to round off measurements to whole numbers), or that the basin may not have been exactly circular or that the brim was wider than the bowl itself. Many reconstructions of the basin, in fact, show a wider brim extending outward from the brim itself by several inches, which might account for the discrepancy.

**According to Galileo – a famous scientist once said:**

**'Mathematics is the language with which God created the universe'.**

Knowledge of pi then bogged down until the 17<sup>th</sup> century. Pi was then called the Ludolphian number, after Ludolph van Ceulen, a German Mathematician. The first Person to use the Greek letter Pi for the number was William Jones, a Welsh mathematician, who coined it in 1706.



Early science, particularly geometry and astronomy/astrology, was connected to the divine for



*seven, disclosing the fourth important fact, that the ratio of the diameter and circumference is as five-fourths to four ...*

which comes close to an explicit claim that  $\pi = 4/1.25 = 3.2$ , as well as  $\sqrt{2} = 10/7 \approx 1.429$ .

This quote is often read as three mutually incompatible assertions, but they fit together well if the statement about  $\sqrt{2}$  is taken to be about the inscribed square (with the circle's diameter as diagonal) rather than the square on the radius (with the chord of  $90^\circ$  as diagonal). Together they describe the circle shown in the figure, whose diameter is 10 and circumference is 32; the chord of  $90^\circ$  is taken to be 7. Both of the values 7 and 32 are within a few percent of the true lengths for a diameter-10 circle which, of course, does not justify Goodwin's presentation of them as exact.

***Squaring the circle*** was the dream of all Greek mathematicians for more than 4000 years but as the great mathematicians proved and showed that pi is an irrational number, a transcendental number so the effort to square the circle was stopped and discouraged by almost all mathematicians of the world till today. The quest to prove whether circle can be squared was stopped by the scientists and mathematicians 120 years ago because of the irrationality and transcendental properties of Pi.

**Pi is approximately 3.1415926.....** the number of times that a circle's diameter will fit around the circle. Pi goes on forever. The exact value of Pi has an infinite decimal expansion of various numbers: its decimal expansion never ends and does not repeat, since Pi is accepted and proved as an irrational and transcendental number.

This infinite sequence of digits has fascinated mathematicians and laymen alike, and much effort over the last few centuries has been put into computing more digits and investigating the number's properties.

**“To ask for the system in pi is like asking, “Is there life after death?” When you die, you'll find out.”**

*---Richard Preston, The Mountains of Pi*

The Pi was also calculated by taking the square root of Number – 10 as:

$$\mathbf{Pi = \sqrt{10} = 3.16227766.....}$$

In the book, 'Introduction to Pi', L.Berggren, J.Borwein and P.Borwein write about the calculation of Pi as:

“The computation of Pi is virtually the only topic from the most ancient stratum of mathematics that is still of serious interest to modern mathematical research. And to pursue this topic as it

developed throughout the millennia is to follow a thread through the history of mathematics that winds through geometry, analysis and special functions, numerical analysis, algebra and number theory. It offers a subject which provides mathematicians with examples of many current mathematical techniques as well as a palpable sense of their historic development.”

**'God exists since mathematics is consistent, and the devil exists since we cannot prove it.'**

*Andre' Weil, French Mathematician*



*(Reference: <http://en.wikipedia.org/wiki/User:Piledhigheranddeeper>)*

## **Famous Mathematicians Who Tried to Calculate Pi in the History:**

Many famous mathematicians and scientists worked to calculate the exact value of Pi. Some famous mathematicians and scientists who worked on Pi are:

1. Egyptian Rhind
2. Babylonians
3. Archimedes
4. Chang Hong
5. Zu Chongzhi
6. Brahmagupta
7. Al – Khwarizmi
8. Fibonacci - **“Pi from now on calculated in decimal places.”**
9. Madhava of Sangamagrama – discovered the infinite power series expansion of pi
10. Jamshid Masud Al Kashi
11. Ludolph Van Ceulen
12. Isaac Newton
13. Kamata
14. Leonhard Euler – used letter pi in his book and pointed that pi may be transcendental
15. Johann Heinrich Lambert – who proved that pi is irrational
16. Rutherford
17. Lehmann
18. Srinivasa Ramanujan

19. D.F. Ferguson
20. Felton
21. J. Guillord
22. Yasumasa Kanada – 1.24 trillion places on Hitachi SR8000/MPP (64 nodes), 600 hours

**Pi – 3.14159265358979323846264338327950288419716939937510...1.24 trillion dps**

Despite much analytical work, and supercomputer calculations that have determined over 1 trillion digits of pi, no simple pattern in the digits has ever been found. Digits of pi are available on web pages, and there is software for calculating pi to billions of digits on any personal computer. Recently in Japan, Yasumasa Kanada and team have calculated its value up to 1.24 trillion decimal places.

Pi has had various names through the ages and all of them are either words or abstract symbols, since pi is a number that cannot be shown completely and exactly in any finite form of representation till today.

**“There’s a beauty to pi that keeps us looking at it.....The digits of pi are extremely random. They really have no pattern, and in mathematics that’s really the same as saying they have every pattern.”**

*---Peter Borwein, 1996*

## **Symbol – $\pi$ :**

The symbol ' $\pi$ ' for Archimedes constant was first introduced in 1706 AD by William Jones when he published '*A New Introduction to Mathematics*'. Although, the same symbol had been used earlier to indicate the circumference of a circle.

The notation became standard after it was adopted by Leonhard Euler. In earlier case, 'Pi' is the first letter of 'Periphēria', the Greek word for periphery or 'perimetron', meaning 'measure around' in Greek.

**“Mathematics.....would certainly have not come into existence if one had known from the beginning that there was in nature no exactly straight line, no actual circle, no absolute magnitude.”**

- *Friedrich Nietzsche – Human, All Too Human*

## **Circle – Different Concepts and Myths**

- The circle or circumference was always one of the primary feminine signs, as opposed to the line or diameter representing masculine spirit.
- Early matrifocal villages had round hearths, round houses, round fences and round defensive shapes.

- The circle was associated with the idea of a protected or consecrated space, the space where all participants are equal.
- Worship places like the Hindu Chakra or Arabic Halka were those in which female influence was prevalent. Pagan sacred dances were circular, as are European folk dances to this day.
- Prehistoric stone circles, like Stonehenge ----- known as the Giants' Dance ----- attest to the ancient love of circularity.
- The concept of equality was still connected with the circle in medieval legends.
- The circle invoked by analogy the full face of the moon, the pupil of the All-Seeing Eye, the circle of the visible horizon and a thousand other natural forms.

## Circle and Definition of God in Hinduism

**'God is a circle whose circumference is nowhere and whose center is everywhere'.**

It is a famous cliché cribbed from a Hindu catechism concerning the deity called the One as:

**“An unbroken circle with no circumference, for it is no-where and everywhere.”**

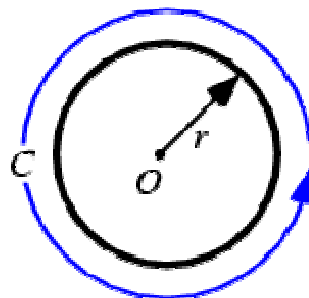
The idea of the 'Cosmos' as an unbroken circle was repeated in the Gnostic image of the world 'Serpent' forming a circle with its tail in its mouth.

## Squaring the Circle – Quadrature:

**“The end of circle-squaring will come only as a consequence of the end of civilization.”**

*--Underwood Dudley, Mathematical Cranks*

In relation with Pi, the most famous problem of all time – squaring the circle is still not solved till today.



Circle



**“No amount of attestation of innumerable and honest witnesses would ever convince anyone versed in mathematical and mechanical science, that a person had squared the circle or discovered perpetual motion.”**

*---Baden Powell, Essays and Reviews, 1860*

An article published on internet about the ‘Squaring the circle’ in 1997 by an anonymous writer mentions that:

“In the mansions of mathematics today, there is no room for one who still thinks about the most popular problem i.e. can circle be squared or squaring the circle. For one hundred and twenty years all mathematicians have been convinced that the nearly 4000 year old problem of squaring the circle is sufficiently understood and it is insoluble or there is no solution to it as we don’t know the rational, real and exact value of pi.

With a prickliness perhaps betraying some lingering anxiety, anyone who wastes further time on this most famous puzzle is regarded as ‘Mathematically incompetent.’

**“God ever geometrizes”**

- **Plato**

Quietly demurring from this starkly intimidating judgment stands ancient Greek civilization itself. They were an extraordinary people, naming whole branches of knowledge we venerate. Hardly the kind to waste their time on a fool’s errand. One can only marvel at the work of Apollonius of Perga – 247-205 BC on conic sections. What impelled this great mind to master such an obscure subject that would no utility for 1800 years? And then we move forward and study Isaac Newton’s – 1642 – 1727 AD, *Principia Mathematica* – 1687 and realize that he could not have made the principles of the ellipse, parabola and hyperbola with which to build on Johannes Kepler’s (1571-1630) interpretation of Tycho Brae’s (1546-1601) naked eye measurements of the motion of the planets. And that Kepler himself first needed Apollonius conics to derive his laws of planetary motion from Brae’s data. From this rich perspective, the instinct that prompted the ancient Greek mathematicians to study conics becomes even more remarkable.

**“It is utterly impossible for one to accomplish the work in a physical way; it must be done metaphysically and geometrically, not mathematically. When approached in this manner the problem is easy of solution. It is stated by occultists that the number 12 squares the circle and it is necessary to take into consideration the process before we can understand this; when correctly understood we know it to be perfectly true.”**

*A. S. Raleigh, Occult Geometry, 1932*

Then when we learn that it was the challenge of squaring the circle which gave birth to the original interest in conics, something warns us to be more careful about dismissing as fruitless any matter the greatest of the Greeks found intellectually most important, but instead strive to reexamine and adjust our own idea of it.

According to historians, leading mathematicians in Greek antiquity would occupy themselves with this geometrical problem known as the ‘quadrature’. What it involves, essentially, is constructing an ideal square with an area equal to that of a given circle, where the radius of the circle is one, an area equal to pi and doing so in a finite number of operations using only a straight edge and a compass.”

**“Let us all give thank, loudly and daily, that we are not cranks devoting all of our energies to convincing the world that Pi is exactly 3.125, 22/7 or  $\sqrt{10}$ . The chance that our lives will be rich, delightful, and full of meaning may be small, but it is greater than the non-zero chance of the circle-squarer.”**

*--Underwood Dudley, Mathematical Cranks*

## **Rectification of the Circle:**

**“The Squaring of the Circle is of great importance to the geometer-cosmologist because for him the circle represents pure, un-manifest spirit-space, while the square represents the manifest and comprehensible world. When a near-equality is drawn between the circle and square, the infinite is able to express its dimensions or qualities through the finite.”**

*--- Robert Lawlor, Sacred Geometry, 1982*

A practically identical problem is the “*rectification of the circle*” i.e. Constructing an ideal straight line equal in length to the circumference of the circle.

This is a modern mathematical and scientific dilemma that scientists and mathematicians themselves stopped even thinking to solve the mystery. Instead they blocked even the efforts of all the people of the world by saying that it is ‘Impossible to square the circle’ till today.

**“The British Association for the Advancement of Science may assume infallibility and authoritatively proclaim that the solution of the problem is impossible; and may consequently decline to permit the consideration of the subject to be introduced into their deliberations.....And yet, *the solution of the problem is extremely simple after all*. It would almost appear as if *its very simplicity had been the grand obstacle which had hitherto stood in the way of its discovery.....I have subjected my theory to every conceivable test, both mathematical and mechanical, with an honest determination to find a flaw if possible; and having failed to do so, I now unhesitatingly propound it, as the true theory on this important question.*”**

*---James Smith, The Quadrature of the Circle, 1861*

Now **what is accepted and believed today** about Pi:

1. Pi is an irrational number.
2. Pi is a transcendental number and non-algebraic.
3. Pi is an approximate and estimated number.
4. Pi is an unending infinite decimal.

5. Is pi normal to base 10? We are not sure about it.
6. Circles cannot be squared – an unaccomplished dream of Greek mathematicians
7. Perfect circle and sphere does'nt exist
8. There is no definite pattern of numbers in pi.
9. Pi cannot be solved or calculated so we have to go with the approximations.

Hundreds of approximations have been done so far to calculate the good approximate value of Pi.

**“This mysterious pi which comes in at every door and window and down every chimney”**

**--Augustus De Morgan, A Budget of Paradoxes**

***But:***

**“The matter of the normalcy or non-normalcy of pi will never, of course, be resolved by electronic computers. We have here an example of a theoretical problem which requires profound mathematical talent and cannot be solved by computations alone. The existence of such problems ought to furnish at least a partial antidote to the disease of computeritis, which seems so rampant today.”**

**--- Howard Eves, *Mathematical Circles Revisited*, 1971**

**Once Goethe quoted:**

**“It has been said that figures rule the world. Maybe, but I am sure that figures show us whether it is being ruled well or badly.”**

We have seen in this book that:

***Perfection and Symmetry is the first rule of God and His Universe and the answer is the same everywhere, i.e. Number – 19.***

## **Perfect Pi and Mathematical Perfection:**

As we have seen that hundreds of famous mathematicians and scientists tried to calculate and prove the value of Pi throughout the history. We take the opposite approach and method to find and reach the exact value of Pi in Mathematics.

Instead of calculating and proving the mathematical value of Pi. Let us assume the values of the Circumference and Diameter of a sphere (Circle in 3 dimensions) with special numbers and after seeing their special and Perfect results with those special numbers, we would reach the

conclusion and prove the value of exact Pi. This approach would be opposite to the conventional approach of calculating and proving the mathematical value of Pi.

*Let us assume:*

$$\begin{aligned} \text{Circumference of the Sphere} &= 19 \\ \text{Diameter of the Sphere} &= 6 \end{aligned}$$

$$\text{Pi} = \text{Circumference/ Diameter of the Sphere} = 19/6$$

$$\text{Pi} = 19/6 = 3.1666666666$$

We are looking for mathematical perfection in all aspects. Let us see whether we can calculate the Perfect mathematical results by these Special and Perfect Numbers, i.e. 6 and 19.

### **Perfect Results with the Perfect Attributes of a Perfect Sphere:**

1. Surface Area of a sphere =  $114 = 6 \times 19$

2. Volume of a sphere =  $114 = 6 \times 19$

3. Diameter x Circumference of a sphere =  $114 = 6 \times 19$

4. 619 -----  $114^{\text{th}}$  Prime Number

5.  $6 \times 19 = 114$

6. Number – 6 is the *first and the smallest ‘Perfect Number’* in Mathematics.

Also  $114 \dots\dots\dots 1 + 1 + 4 = 6 \dots\dots\dots$  Perfect Diameter of a Perfect Sphere

7. Perfect Hemisphere (57) + Perfect Hemisphere (57) =  $114 = 19 \times 6$

8. All Perfect Numbers end either with Number – 6 (first and smallest perfect number) or Number – 8 (Number – 19 is the  $8^{\text{th}}$  Prime Number).

6..... $1^{\text{st}}$  and Smallest Perfect Number.....Perfect Diameter of the Perfect Sphere

19..... $8^{\text{th}}$  Prime Number .....Perfect Circumference of the Perfect Sphere

9.  $19 \times 19 \dots\dots\dots$  Perfect Super Cycle producing new cycles or circles of  $360^\circ$

$$\text{Perfect Super Cycle} = 19 \times 19 = 361$$

10. The surface area of cube of Number – 6 is 216 and the surface area of cube of Number – 19 is 2166. The Number – 216 is the 109<sup>th</sup> Even Number.

**216.....109<sup>th</sup> Even Number**

11. The Number – 19 contains two numbers – 1 and 9. The Pi expressed in these two numbers would be:

$$\mathbf{Pi = \sqrt{(1 + 9) + (1 + 9)^{\circ}}$$

12. The Number 19 .....  $1 + 9 = 10$

Perfect Pi can be expressed in Number – 10 as:

$$\mathbf{Pi = \sqrt{10 + 10^{\circ}} = \sqrt{10.027777777} = 3.166666.....}$$

13. There are 360° in a complete and Perfect Circle. 360° can be expressed as:

$$\mathbf{360^{\circ} = (19 + 1)^{\circ} \times (19 - 1)^{\circ}}$$

14. The Number – 19 is the 8<sup>th</sup> Prime Number in Mathematics.

**19.....8<sup>th</sup> Prime Number**

Adding 19 and 8, we would get -----  $19 + 8 = 27$

$$\mathbf{19 + 8 = 27}$$

The value of 1° in 360° is equal to:

$$\mathbf{1^{\circ} = 1/ 360 = 0.0027.....}$$

The value of 1° contains the Number – 27

15. The Super Cycle –  $19 \times 19 = 361$  may be expressed as:

$$\mathbf{361..... 19 \times 19 \times 01}$$

16. 360° is equal to:

$$\mathbf{360^{\circ} ..... 6 \times 6 \times 10}$$

17. The Super cycle is  $19 \times 19 = 361$ . The number – 361 contains 3 numbers – 3, 6 and 1.

The Perfect Pi also contains 3 numbers, i.e.

$$\mathbf{\text{Pi} = 3.16\dots\dots\dots 3, 1 \text{ and } 6}$$

Same numbers of the Super Cycle – 3, 6 and 1

18. Pi can also be written as a fraction of 3 numbers as:

**Pi = 3 (1/6)**.....contains 3 numbers of 3, 1 and 6. The Super Cycle –  $19 \times 19 = 361$  also have these 3 numbers – 3, 6 and 1.

19. Perfect Pi = 3.1666.....

If we add the 4 numbers of ‘Perfect Pi’ after the decimal, we see:

$$\mathbf{19 = 1 + 6 + 6 + 6}$$

*Why to add 4 Numbers of Perfect Pi after decimal?*

*Number – 6 is the 4<sup>th</sup> Even number in Mathematics.*

(Even Numbers: 0, 2, 4, 6,8,.....)

*There are 4 perfect numbers below 10,000.*

20. Perfect Pi = 3.1666.....

If we round the numbers of Pi, we would see:

$$\mathbf{\text{Perfect Pi} = 3.167\dots\dots\dots}$$

$$\mathbf{67\dots\dots\dots 19^{\text{th}} \text{ Prime Number}}$$

21. Perfect Pi = 3.16..... The Super Cycle =  $19 \times 19 = 361$ . It can be expressed as:

$$\mathbf{19 \times 19 = 361 = [(3 \times 6) + 1] \times [(3 \times 6) + 1]}$$

The result of  $19 \times 19 = 361$  contains 3 Numbers – 3, 6 and 1. If we see the ‘Perfect Pi’, it also contains 3 Numbers, 3, 1 and 6 starting with Number – 3

**Perfect Pi = 3.16.....3, 1 and 6 ----- same as 3, 6 and 1 of 361**

22. Perfect Pi = 3.16.....

If we add the numbers on the left side of the decimal and the number to the right side of the decimal of the Perfect Pi, we see:

$$\text{Perfect Pi} = 3.16\dots\dots\dots 3 + 16 = 19$$

23. Perfect Pi = 3.16..... Pi value contains the number – 16 to the right side of the decimal.

If we upside down the Number – 16 it becomes Number – 19 and vice versa as:

$$\begin{array}{r} 16\dots\dots\dots 19 \\ 19\dots\dots\dots 16 \end{array}$$

**1619.....also a Prime Number**

24.  $19 \times 19 = 361$ . The reversal of the Number – 361 is 163.

There is a special pattern of numbers in the number - 36163 and if we add the numbers of 36163, we see:

$$36163\dots\dots\dots = 3 + 6 + 1 + 6 + 3 = 19$$

If we see the Numbers carefully, we see a clear pattern of numbers that 3 is coming in the start and end, Number – 1 is coming in the middle of the numbers and Number – 6 is the number next to Number – 1 from both sides. The numeric sum of all these numbers in this special pattern is also Number – 19.

25. All the Perfect Numbers in Mathematics end either with Number – 6 or Number – 8.

The Perfect Pi is ending with:

*Perfect Pi = 3.16666..... Number – 6.....Perfect Numbers end with 6 or 8 & Number – 19 is the 8<sup>th</sup> Prime Number.....8.....Perfect Numbers end with 6 or 8*

26. The Perfect Pi =  $19/6$  contains two numbers 19 and 6. Now we see the special effects of the numbers in 19 and 6

There are 3 numbers in 19 and 6 as: 1, 9 and 6. There are 3 perfect squares containing these 3 numbers as:

$$13 \times 13 = 169$$

$$31 \times 31 = 961$$

$$14 \times 14 = 196$$

$$\begin{array}{l} 619 \dots\dots\dots 114^{\text{th}} \text{ Prime Number} \\ 6 \times 19 \dots\dots\dots 114 \end{array}$$

The reversal number of 169 (13 x 13) is 961 (31 x 31). Amazingly, the reversal number of 13 is 31.

27. Perfect Pi = Super Cycle/ 114

$$\text{Perfect Pi} = 361 / 114 = 3.1666 \dots\dots\dots$$

28. Perfect Pi expressed in 114 and 360 as:

$$\text{Perfect Pi} = 114 \times 10 / 360$$

29. The Volume and the Surface Area of the Perfect Sphere is 114.

$$114 \dots\dots\dots 1 + 1 + 4 \dots\dots\dots 6$$

114 \dots\dots\dots 6 \dots\dots\dots Number 6 is the first and the smallest Perfect Number

$$114 \dots\dots\dots 6 \times 19 \dots\dots\dots \text{Number} - 19 \times 6 \text{ times}$$

30. The mathematical value of the Golden Ratio is:

$$\text{Golden Ratio} = 1.618 \dots\dots\dots$$

If we add the numbers on both sides of the decimal, we would get:

$$1.618 \dots\dots\dots 1 + 618 = 619$$

$$619 \dots\dots\dots 114^{\text{th}} \text{ Prime Number in Mathematics}$$

31. The Circumference of the Perfect Sphere is 19. The Number – 19 contains two numbers: 9 and 1

$$9 + 1 = 10 \dots\dots\dots \text{Number 19 is the } 10^{\text{th}} \text{ Odd number in Mathematics}$$

$$9 - 1 = 8 \dots\dots\dots \text{Number 19 is the } 8^{\text{th}} \text{ Odd number in Mathematics}$$

32. The Perfect Pi is the perfect ratio of 19 and 6. Now we see the amazing relationship of 19 and



6 by applying mathematical operations on these numbers:

**6 x 19 = 114..... Surface Area and Volume of the Perfect Sphere**

**619..... 114<sup>th</sup> Prime Number**

**19 - 6 = 13.....6<sup>th</sup> Prime Number----- 13 + 6 = 19.....Perfect Circumference**

**19 + 6 = 25.....13<sup>th</sup> Odd Number-----25 + 13 = 38 = 19 x 2 = 38**

**19/6 = Perfect Ratio of Perfect Circumference to the Perfect Diameter of a Perfect Sphere**

**33.** The Perfect Cube of Number - 6 has a perfect Surface Area 216 and a perfect Volume of 216.

Surface Area of Perfect Cube of Number - 6 = 216 = Volume of Perfect Cube of 6

The mathematical positions of the numbers in 216 are:

**2.....1<sup>st</sup> Prime Number**

**1.....1<sup>st</sup> Odd Number**

**6.....4<sup>th</sup> Even Number**

**The Number - 216 is indicating another number - 114 (19 x 6)**

**34.** The Perfect Pi = 3.166.....

Perfect Pi = 3.**166**.....

If we add the numbers on the right side of the decimal as:

1 + 66 = 67.....19<sup>th</sup> Prime Number

**35.** Hemisphere is half the Sphere. Perfect reflective symmetry is achieved in the Hemisphere with the perfect Pi as:

***Surface Area of the Perfect Hemisphere = 57 = 19 x 3***

***Volume of the Perfect Hemisphere = 57 = 19 x 3***

***Surface Area of the Perfect Hemisphere = 57 = 19 x 3 = Area of the Hemisphere (irrespective of the units of Surface Area and the Volume)***

The Surface Area of 57 of one part of the Sphere is reflecting equally in the other part of the Sphere i.e. 57

**Surface Area of 1<sup>st</sup> equal part of the sphere = 57 = Surface Area of 2<sup>nd</sup> equal part of the Sphere**

**Volume of 1<sup>st</sup> equal part of the sphere = 57 = Volume of 2<sup>nd</sup> equal part of the Sphere**

Hence, the Reflective symmetry is achieved, i.e. the surface area and volume of a hemisphere is 57 of both equal parts of a sphere.

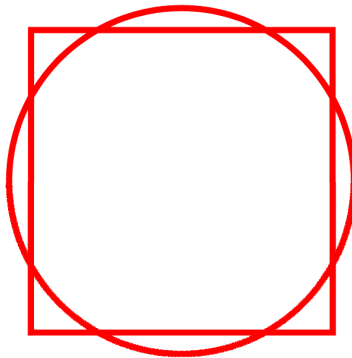
**57 = 3 x 19.....Hemisphere showing reflective symmetry**

**36.** Perfect rotational symmetry is also achieved with the perfect Pi as Pi is real, rational and perfect ratio of two integers i.e. 19 and 6

$$\mathbf{\pi = 19/6}$$

**37. Squaring the Circle** is now possible with the Perfect Pi as we can see in the following example:

**Area of a Square = Area of a Circle**



Now suppose the area of a Square = 15 x 15 = 225

$$\mathbf{\text{Area of a circle} = \pi \times (\text{radius})^2 = 225}$$

If  $\pi = 19/6$ ,

$$\text{Radius}^2 = 225 \times 6/19$$

$$\text{Radius} = \sqrt{(225 \times 6)/19}$$

$$\text{Diameter} = \sqrt{(225 \times 4 \times 6)/19}$$

$$\text{Circumference} = (19/6) \times \sqrt{(225 \times 4 \times 6)/19}$$

$$\text{Area of a Circle} = \pi \times (\text{Radius})^2$$

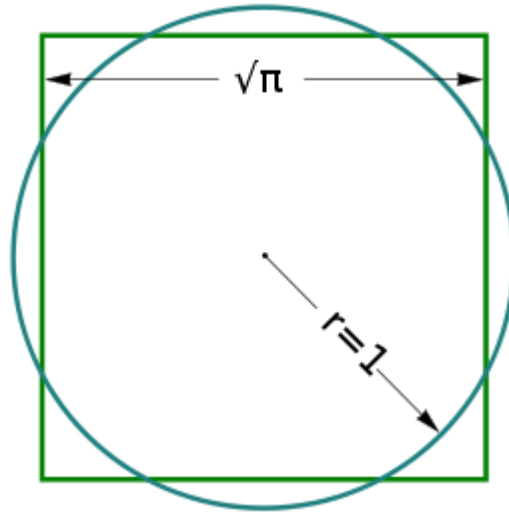
$$\text{Area of a Circle} = (19/6) \times [(225 \times 6)/19]$$

$$\text{Area of a Circle} = 19/6 \times [(225 \times 6)/19]$$

= 225

**Area of a Circle = 225 = Area of a Square**

Squaring of a Circle is possible only with the Perfect value of Pi as 19/6.



If radius = 1

**Area of a Circle =  $\pi r^2 = \pi \times (1)^2 = (19/6) \times 1^2 = 19/6$**

Side of a Square =  $\sqrt{\pi}$

**Area of a Square =  $\sqrt{\pi} \times \sqrt{\pi} = \pi = 19/6$**

**Area of a Circle = 19/6 = Area of a Square**

**38. Rectification of a circle** is another unsolved geometry problem. But it is now possible with Perfect Pi – 3.166666666666.....

Rectification of the circle means constructing an ideal straight line equal in length to the circumference of the circle.

- If the diameter of a circle is 6, then circumference of a circle is 19, we can draw a straight line of 19.
- If the diameter of a circle is 36, then circumference of a circle is 114, we can draw a straight line of 114.
- If the diameter of a circle is 114, then circumference is 361, we can draw a straight line of 361.

- If the diameter of a circle is 60, then circumference is 190, we can draw a straight line of 190.

**39.** Like Squaring the Circle is now possible with the Perfect value of Pi as 19/6. **Cubing the Sphere** is also possible with this Perfect Pi.

Suppose the Surface Area of a sphere = 216.

Radius of a sphere =  $\sqrt{(1296/76)}$   
 Diameter of a sphere =  $2 \times \sqrt{(1296/76)}$   
 Perfect Pi =  $19/6 = 3.166666\dots\dots$

Surface Area of a sphere with radius equal to =  $4 \times \pi \times (r)^2$   
 = 216

**Surface Area of a sphere = Surface Area of a cube**

Surface Area of a cube =  $6 (a \times a)$

And a = one side of a cube, which has 6 equal sides.

Surface Area of a Sphere = Surface Area of a Cube

$$216 = 6 (a \times a)$$

$$(a \times a) = 6 \times 6 = 36$$

Take the square root on both sides to get the value of a

$a = \sqrt{36}$   
 $a = 6$   
 So Area of a Cube =  $6 (6 \times 6)$   
 = 216.

$$216 = 216$$

**Surface Area of a Sphere = Surface Area of a Cube**

**“The science of mathematics presents the most brilliant example of how pure reason may successfully enlarge its domain without the aid of experience.”**

*Emmanuel Kant*

**40.** The Number – 496 is the 3<sup>rd</sup> Perfect Number in mathematics.

$$496 = 31 \times 16$$

If we see the equation closely, we would notice that **31 x 16** are the numbers appearing in the Perfect Pi as:

$$\text{Perfect Pi} = 3.16$$

The Number – 1 is common in both the Numbers 31 and 16, so writing Number – 1 only one time, we would see that 3, 1 and 6 are common numbers in Ali Pi and 31 x 16.

41. The numeric sum or root number of 3<sup>rd</sup> Perfect Number – 496 is:

**496 = 4 + 9 + 6 = 19.....Perfect Circumference of a Perfect Sphere**

42. The 4<sup>th</sup> Perfect Number – 8128 in Mathematics is written as:

**8128 = 8 + 1 + 2 + 8 = 19.....Perfect Circumference of a Perfect Sphere**

43. The 6<sup>th</sup> and 19<sup>th</sup> Powerful numbers in Mathematics are:

**25 ----- 6<sup>th</sup> Powerful Number**

**144 ----- 19<sup>th</sup> Powerful Number**

**(6 x 19) -- Powerful Numbers ----- 25 x 144 = 3600 = 360 x 10**

**(6 x 19) – Powerful Numbers ----- 360 x 10**

**360 = (19 + 1) x (19 – 1)**

**10 = (1 + 9)**

**(6 x 19) – Powerful Numbers----- [(19 + 1) x (19 – 1)] x [(1 + 9)]**

44. The 19<sup>th</sup> and 6<sup>th</sup> Even Numbers in Mathematics are:

**36.....19<sup>th</sup> Even Number**

**10..... 6<sup>th</sup> Even Number**

**(19 x 6) – Even Numbers----- 36 x 10 = 360**

**360 = (19 + 1) x (19 – 1)**

**360.....360° degrees in a ‘Perfect Sphere’**

**45. There are 57 Even Numbers below ----- 114**

**There are 57 Odd Numbers below ----- 114**

**57 Even Numbers + 57 Odd Numbers ----- 114**

**57 ..... Perfect Hemisphere**

**(19 x 3) Even Numbers + (19 x 3) Odd Numbers ..... 114**

**57 (Even Hemisphere) + 57 (Odd Hemisphere) ..... 114**

**46. There are 30 Prime Numbers below ----- 114**

**Number 30 ..... 19<sup>th</sup> Composite Number**

$$30 \times 12 = 360^\circ = (19 + 1) \times (19 - 1)$$

Number - 12 is the 7<sup>th</sup> Even Number. Adding both the number - 12 and number - 7, we see:

12.....7<sup>th</sup> Even Number

12 + 7 = 19.....Perfect Circumference of a Perfect Sphere

**47. We all know that Perfection and Completion means 100%**

$$\text{Perfection and Completion} = 100\%$$

**All Perfect Numbers in Mathematics end either with Number - 6 or Number - 8.**

$$100 = (6 \times 6) + (8 \times 8)$$

6 ----- 6 is the 1<sup>st</sup> Perfect Number -----6 = Perfect Diameter of a Perfect Sphere

8 ----- 19 is the 8<sup>th</sup> Prime Number -----19 = Perfect Circumference of a Perfect Sphere

$$100 = (36) + (64) = (3 + 6) + (6 + 4) = (9) + (10)$$

**100 ----- 19 -----Perfection**

**48. There is a Geometrical link between 114 (19 x 6) and Perfect Pi - 19/6**

We know that:

**1 Circle = 360° degrees**

**1° degree = 1/ 360 = 0.0027777777.....**

$$10^\circ \text{ degrees} = 10/360 = 0.02777777\dots\dots$$

$$36^\circ = 36/360 = 0.1$$

$$\text{Pi} = 19/6 = 3.166666$$

If divide the Perfect Pi by 114

$$\text{Pi}/114 = 0.027777777777\dots\dots\dots 10^\circ \text{ degrees}$$

That is the exact value of 10° degrees of a Circle of 360° degrees (36 x 10 equal parts).

$$1 \text{ complete circle} = 360^\circ = 36 \times 10^\circ = 36 \times (\text{Pi}/114) = 36 \times 0.02777777777\dots\dots = 1$$

36 equal parts of 10° degrees in a circle = 0.02777777 x 36 = 1 complete circle of 360° degrees.

49. All the Perfect numbers in mathematics end either with Number – 6 or with Number – 8 as we have seen in the previous chapter.

### Perfect Numbers – 6, 28, 496, 8128,.....

Adding both the numbers – 6 and 8, we would get:

$$6 + 8 = 14$$

Now we multiply the number – 14 with number – 14 or take the square of Number – 14, we would get an amazing result with amazing numbers as:

$$14 \times 14 = 196$$

$$196\dots\dots\dots 19 \text{ and } 6$$

The square of (6 + 8 = 14) yields amazing numbers – 19 and 6. All the perfect numbers have a relationship with numbers 6 and 8 and hidden relationship with 19 and 6.

50. The square root of number -19 has the continued fraction expansion...

$$\text{Square root of } 19 = 4 + \frac{1}{2} + \frac{1}{1} + \frac{1}{3} + \frac{1}{1} + \frac{1}{2} + \frac{1}{8} + \frac{1}{2} + \frac{1}{1} + \frac{1}{3} + \frac{1}{1} + \frac{1}{2} + \frac{1}{8} + \frac{1}{2} + \frac{1}{1} + \frac{1}{3} + \frac{1}{1} + \dots\dots\dots$$

### It recurs with length – Six - 6

The Convergent immediately before the point from which it repeats is 170/39 and Lagrange’s theorem will be the smallest solution to Pell’s equation.





*Infinite Perfection of Perfect Number – 6 in Perfect Pi.....3.166666.....*

**Authentication and Approval from the renowned Mathematicians of all times:**

Leonhard Euler (1773 CE), famous Swiss mathematician developed a famous equation for Pi as:

$$\mathbf{\pi = \lim(n \rightarrow \infty)[ (1/n) + (1/6n^2) + 4n\{(1/n^2+1) + (1/n^2+2^2) + \dots + (1/n^2+n^2)\}]}$$

**For n = 1, the value of Pi = 3.166666666.....**

Perfect Pi = 3.1666666666666666..... as calculated by the famous mathematician of all times – Leonhard Euler

*(Reference: This famous equation is discovered in a correspondence to Christian Goldbach, Castellanos, ‘The Ubiquitous  $\pi$ ’,” Page – 73 – mentioned in ‘A Biography of the World’s Most Mysterious Number by Alfred S. Posamentier & Ingmar Lehmann, Page – 152)*

John Davis, a University Professor and a renowned mathematician of his times, wrote a book, ‘A measure of the Circle’ in 1854 and claimed that he calculated the real value of Pi as:

**Pi = 19/6.....as calculated by John Davis in 1854**

“I have found by the operation of figures that this proportion is as 6 to 19. Now, in order to make a ratio, I divide the 19 by 6, which gives 3.166666.....I am asked what evidence I have to prove that the proportion the diameter of a circle has to its circumference is as 6 to 19? I answer, there is no other way to prove that an apple is sour, and why it is so, than by common consent.”

*John Davis, The Measure of the Circle, 1854*

*(Reference: The Joy of Pi by David Blatner - Pg:100)*

“I have travelled with Mr. John Davis, in England and the United States, for six years; we have visited all the most learned mathematicians that we could hear of, but have never found one that attempted a disapproval of his work. I have examined, to the best of my ability, the works of writers on mathematics since the time of Euclid; and without a doubt, according to mathematics, he has solved the wonderful problem, surprising as it may appear to many.

Weights and measures can now be made perfect, and to the satisfaction of every man, woman, and child. Space and distance, which have never been known, and now found by John Davis.”

*Sabin Smith*

*(Reference: Testimonials - The Measure of the Circle - John Davis)*

All the mathematicians of that era approved the mathematical work and calculation of Pi as 19 divided by 6.

**Pi calculated by John Davis & approved by the mathematicians of his era:**

“I have examined the measure of the circle by John Davis, and beyond all doubt it is perfect measure.”

*Henry R. Savory, Civil and Military Engineer*

“I have examined the measure of the circle by Mr. John Davis, and find it, in my opinion, a most complete, scientific, mathematical measure of the circle.”

*Thomas Guille, Professor of Mathematics  
(Reference: Testimonials – The Measure of the Circle, John Davis)*

***Pi calculated by John Davis = 19/6 = 3.16666.....***

*Hon Han Shu in 130 AD and Brahmagupta in 640 AD* calculated the value of Pi as:

$$\mathbf{Pi = \sqrt{10} = 3.162277.....}$$

Had they added 10° to the number 10, they would have got the exact and real value of Pi.

If we just add 10° to the above formula of Pi, we would get the exact and perfect value of Pi as:

$$\mathbf{Perfect Pi = \sqrt{10 + 10^\circ} = \sqrt{10.027777777} = 3.166666.....}$$



“Amazingly, lack of formal education can be an advantage. We get stuck in our old ways. Sometimes, progress is made when someone from the outside looks at mathematics with new eyes.”

*Doris Schattschneider, Los Angeles Times*

## **Egyptian Scribe Ahmes – First Ever Pi – 3.16049 Known in History:**

The First ever value found by Egyptians 2000 BC - Rhind Papyrus, approximately 4000 years ago was 3.160493827, which is approximately equal to the Final Perfect Value of Pi discovered by me. The Egyptian scribe – Ahmes wrote the oldest known text to give an approximate value for Pi, citing a Middle Kingdom Papyrus, corresponding to the value of 256 divided by 81 or 3.1605

$$\text{Egyptian Scribe – Ahmes Pi } (\pi) = 256/81 = 3.160493827$$

$$\text{Perfect Pi } (\pi) = 3.16666666\dots\dots\dots$$

## **Correction to the First and the Oldest Known Value of Pi:**

The Egyptian scribe Ahmes calculated the oldest known pi, the first pi in the history as 256 divided by 81. Had they calculated the value of pi to be 247 divided by 78, they would have got the correct and rational value of Pi at that time.

$$\text{Egyptian Scribe Ahmes – Pi } (\pi) = 256/81 = 3.1605$$

$$\text{Perfect Pi } (\pi) = 247/78 = (19 \times 13) / (6 \times 13) = 3.166666\dots\dots\dots$$

The difference in circumference of a circle is  $256 - 247 = 9$  and the difference in diameter of that circle is  $81 - 78 = 3$ .

So the corrected value of Egyptian scribe -Ahmes would be:

$$\text{Perfect Pi} = 247/78 = (19 \times 13) / (6 \times 13) = 3.166666\dots\dots\dots$$

$$\text{Perfect Pi } (\pi) = 247/78 = 3.1666\dots\dots\dots\text{corrected value}$$

I define the Perfect Pi as:

*Perfect Pi = Signature of the God on the Universe/ Perfection of God in the Universe*

$$\text{Perfect Pi} = 19/6$$

$$\text{Perfect Pi } (\pi) = \text{Perfect Circumference/Perfect Diameter} = 19/6$$

*Perfect Pi = 3.1666\dots\dots is a constant, rational and real value of Pi (π)*

When all mathematicians and scientists agree that Mathematics is the language of God, then why



## Completion of the World by God and Pi ( $\pi$ ) Day:

It is mentioned in the Holy Bible – Book of Genesis - 2,

“By the **seventh day** God had finished the work he had been doing; so on the seventh day he rested from all his work. Then God blessed the seventh day and made it holy, because on it he rested from all the work of creating that he had done.”

(Reference: Genesis 2, The Holy Bible)

Chapter one of the Book of Genesis in the Holy Bible describes God's creation of the world by divine speech in six days and the designation of the seventh day as **Sabbath**, a divinely ordained day of rest.

**Sabbath ----- Saturday**

It is also written in Exodus 20.19f as:

“Six days shalt thou labor, and do all thy work....For in **Six days** the LORD made heaven and earth, the sea, and all that in them is, and **rested the seventh day**: wherefore the LORD blessed the **Sabbath day**, and hallowed it.”

All Christians and Jews consider ‘**Saturday**’ as the Holy Day and that is why there is an official holiday on Saturday every week in most part of the world.

So according to the Holy Bible, God started the creation of the world on Sunday, He would have finished the work on Friday, i.e. the sixth day and on the Seventh day of Saturday he rested from all his work and that is why God blessed the seventh day i.e. Saturday and made it Holy.

If we assume that God started the creation of the world on 16<sup>th</sup> March, then 16<sup>th</sup> March would have fallen on Sunday and God finished the work on the Seventh day of Sabbath, i.e. Saturday and 21<sup>st</sup> March would be Saturday as per our assumption.

**16<sup>th</sup> March ----- Sunday**

**21<sup>st</sup> March ----- Saturday**

**21<sup>st</sup> March** is also the start of the **first Astrological month of Aries** and many Persian nations like Iran, Azerbaijan, etc celebrate the new year of ‘Naurooz’ on 21<sup>st</sup> March every year.

**Pi ( $\pi$ ) Day ----- 16<sup>th</sup> March ----- Sunday**

**Sunday** is also the official holiday in most countries of the world. So both the Start of the creation of the world by God and Finishing of the work by God are on Sunday and Saturday and both days are the official holidays every week in most countries of the world.

**Pi ( $\pi$ ) Day and Sunday:**

**Pi ( $\pi$ ) Day ----- 16<sup>th</sup> March ----- Sunday**

**Sunday** is the 7<sup>th</sup> day of the week.

There are 12 months in a year and the Number – 12 is the 7<sup>th</sup> Even Number

$$12 + 7 = 19$$

There are 7 days in a week and 52 weeks in a year. The Number – 52 is the 27<sup>th</sup> Even Number. There are also 52 Sundays in a year usually. We also know that 19 is the 8<sup>th</sup> Prime Number.

**52.....27<sup>th</sup> Even Number**

**19.....8<sup>th</sup> Prime Number ..... 19 + 8 = 27**

There are 4 weeks in a month and usually 4 Sundays every month. We also know that March 16<sup>th</sup> is the 76<sup>th</sup> Day in a complete leap year of 366 days.

**4 Sundays ----- Every month (usually)**

**19 x 4 = 76<sup>th</sup> Day ----- 16<sup>th</sup> March in any leap year of 366 days**

## 19 Perfect Results with Perfect Pi ( $\pi$ ):

The Perfect results are showing with the Perfect Numbers of Perfect Pi. So we can say that:

1. Perfect Sphere exists in the universe and mathematics.
2. Perfect Circle exists in science and mathematics.
3. Perfect Circle can be 'Squared – Quadrature' is possible.
4. Perfect Sphere can be 'Cubed.'
5. Rectification of the Perfect Circle is possible i.e. the circumference can be drawn as a straight line.
6. Pi is a rational and real number and ratio of two real perfect integers.
7. Pi is a normal number and shows a regular pattern of decimal expansion of only one number i.e. Number – 6.
8. Pi is normal to base 10 with unique infinite decimal expansion ending with recurring decimal.
9. Pi is a perfect and exact mathematical number.
10. Pi is a symmetrical and flawless number.
11. Pi is a plane solution to a geometry problem.
12. Pi is a unique and independent number.
13. Pi is a natural and definite number.
14. Pi is a universal constant number.
15. Pi is an algebraic number.
16. Pi has perfect dimensions of circumference of 19 and diameter of 6.
17. Pi is a symmetrical number.
18. Pi is a real number.
19. Pi is a perfect ratio of 19 divided by 6.

## 7 - Perfect Formulas of Perfect Pi:

1. Perfect Pi =  $19/6 = 3.16666\dots$
2. Perfect Pi =  $\sqrt{10 + 10^0} = \sqrt{10.0277777\dots} = 3.16666\dots$
3. Perfect Pi =  $114/36 = 3.16666\dots$
4. Perfect Pi =  $361/114 = 3.16666\dots$
5. Perfect Pi =  $3 + 1/6 = 3.1666666\dots$
6. Perfect Pi =  $3 + 60/360 = 3.16666666\dots$
7. Perfect Pi =  $\sqrt{(1 + 9) + (1 + 9)^0} = 3.16666\dots$

*"Knowledge is a point, ignorant people spread it."  
Ali*

## Perfect Circle and 19



Alexander Pope wrote in *His Essay on Man*:

“Order is heaven’s first law.”

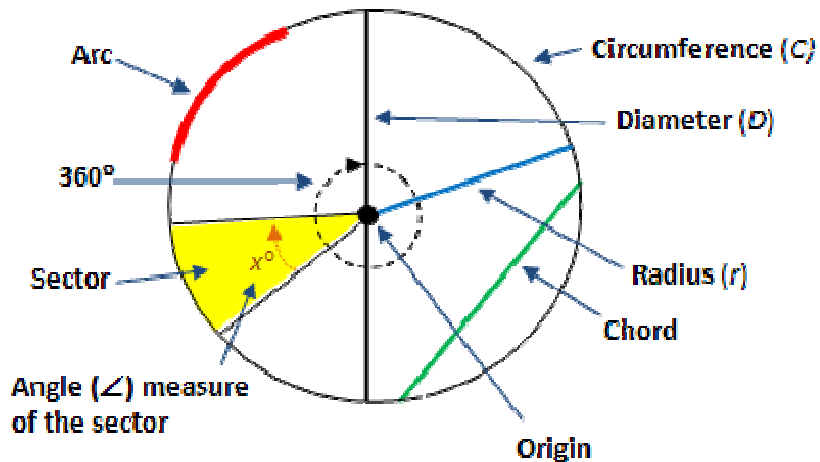
Mathematicians throughout the history of mankind strongly believed that the ‘Perfect Circle’ does not exist because they could not find the perfect circumference, perfect diameter and perfect pi for that perfect circle. However, they tried so many ways to find the exact and perfect value of Pi.

**But:**

*Circle is itself a Perfect and Universal shape in all the geometrical shapes.*

## Circles

### Parts of a Circle



Pi is also described as “How much bigger is the circumference of a circle than the diameter.” In



Euclidean plane geometry, Pi is defined either as the ratio of a circle's circumference to its diameter, or as the ratio of a circle's area to the area of a square whose side is a radius.

Now we would see the model of a "Perfect Circle" by putting the same perfect values of a 'Perfect Sphere'. We don't have to prove the perfect circle because perfect circle attributes are based on 'Perfect Sphere' attributes and they are:

- 1. Circumference of a Perfect Circle = 19**
- 2. Diameter of a Perfect Circle = 6**
- 3. Radius of a Perfect Circle = 3**

Perfect Pi = Circumference of a Perfect Circle/ Diameter of a Perfect Circle

$$\text{Perfect Pi} = 19/6 = 3.1666\text{.....}$$

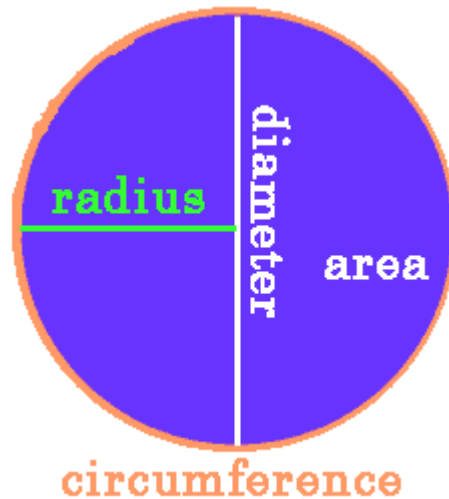
Now we calculate:

So the Area of a Perfect Circle = Pi x (r x r) = 1/4 x Pi x (d x d)

Area of a Perfect Circle = 19/6 x (3 x 3) = 1/4 x 19/6 x (6x 6)

$$\text{Area of a Perfect Circle} = 28.5$$

Now pi is equal to "Ratio of a Perfect's Circle's Area to the area of a square whose side is a radius."



Now the side which is a radius = 3

Area of a Square = 3 x 3 = 9

Perfect Pi = Prefect's Circle's Area / Area of a Square whose side is a radius

Perfect Pi =  $28.5 / 9 = 3.1666666666 \dots\dots\dots$

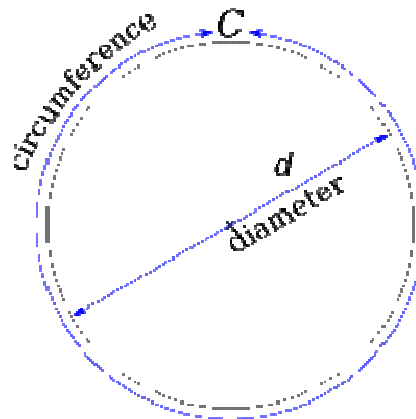
Perfect Pi =  $3.166666\dots\dots\dots$  or  $19/6$  or  $3 + 1/6$

### Perfect 6 -Dimensions of a Perfect Circle:

1. Circumference – 19
2. Diameter – 6
3. Radius – 3
4. Degrees –  $360^\circ$
5. Area = 28.5
6. Pi =  $19/6$

So, the Perfect Circle can be defined as:

### Definition of a Perfect Circle:



A circle of  $360^\circ$  degrees from all sides in 2 dimensions with a perfect constant diameter of six (6), radius of three (3) , circumference of nineteen (19) and the ratio of the area of a Perfect circle to the area of a square whose side is the radius and the ratio of the circumference to the diameter of a Perfect Circle should be same i.e.  $3.1666\dots\dots$  and its area would be 28.5 and all its values of circumference, radius and diameter should be equal to that of a Perfect Sphere is called a Perfect Circle.

## **360° and 19:**

There are 360° degrees in a complete and perfect Circle.

$$360^\circ = 12 \times 30^\circ$$

$$12 \dots \dots \dots 7^{\text{th}} \text{ Even Number and } 12 + 7 = 19$$

$$30 \text{ -----} 19^{\text{th}} \text{ Composite Number}$$

$$360^\circ = (19 - 1)^\circ \times (19 + 1)$$

$$360^\circ = 6 \times 6 \times 10$$

$$360^\circ = 12 \times 30^\circ = (19 - 1)^\circ \times (19 + 1) = 6 \times 6 \times 10$$

## **Area of a Perfect Circle and 19:**

### **1. Two third of the Area of a Perfect Circle:**

Area of a Perfect Circle = 28

$$\text{Two third of the Area of a Perfect Circle} = 28.5 \times (2/3) = 19$$

$$19 = \text{two third of the Area of a Perfect Circle}$$

### **2. One Ninth of the Area of a Perfect Circle:**

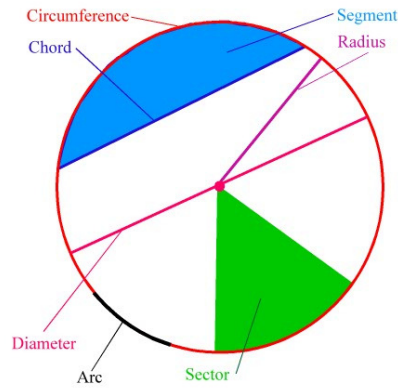
Area of a Perfect Circle = 28

$$\text{One ninth of the Area of a Perfect Circle} = 28.5 \times (1/9) = 3.166666 \dots \dots \dots$$

$$28.5 \times (1/9) = 3.1666666666 \dots \dots \dots = \text{Perfect Pi}$$

$$\text{Perfect Pi} = (1/9) \times \text{Area of a Perfect Circle (28.5)} = 3.16666 \dots \dots \dots$$

$$\text{Perfect Pi} = (1/9) \times (28.5) = 3.1666 \dots \dots \dots$$



So a Perfect Circle with an Area of 28.5, when divided into 9 equal parts gives every part equal to **Perfect Pi = 3.16666..... or 19/6**

**The Area of every 9<sup>th</sup> Part of a Perfect Circle is equal to Ali Pi = 19/6 = 3.16666.....**

If we note the numbers carefully, we see that **ratio 1/9 contains two numbers 1 and 9**, which are the same numbers in Number – 19.

So **both the numbers 1 and 9** are very important in the calculations of the Perfect Circle.

## Number – 9 and 19



- Number – 19 can be written as  $9 + 1 + 9 = 19$
  - Number – 19 is the 8<sup>th</sup> Prime Number and  $19 + 8 = 27 \dots\dots\dots 2 + 7 = 9$
  - $360^\circ = 9^\circ \times [(19 + 1) + (19 + 10)]$
  - $360^\circ \dots\dots\dots 3 + 6 + 0 = 9 \dots\dots\dots 360^\circ = (19 - 1)^\circ \times (19 + 1)$
  - The square of 9 is 81. The difference of 100 and 19 is  $100 - 19 = 81 = 9 \times 9$
  - The difference of 19 and 9 is 10 as:  $19 - 9 = 10 \dots\dots\dots 6^{\text{th}}$  Even Number
  - If we add 19 and 9, we would get:  $19 + 9 = 28 \dots\dots\dots 2^{\text{nd}}$  Perfect Number
  - $19 \times 9 = 171 \dots\dots\dots 1 + 7 + 1 = 9$
  - The root number of all these numbers in a circle of  $360^\circ$  is 9 as:  
 $90^\circ \dots\dots 180^\circ \dots\dots 270^\circ \dots\dots 360^\circ$
- $90 \dots\dots\dots 9 + 0 = 9 \dots\dots\dots 109 - 19 = 90$   
 $180 \dots\dots\dots 1 + 8 = 9 \dots\dots\dots 199 - 19 = 180$   
 $270 \dots\dots\dots 2 + 7 + 0 = 9 \dots\dots\dots 19 \text{ is the } 8^{\text{th}} \text{ Prime Number } \text{----} 19 + 8 = 27 \dots\dots 2 + 7 = 9$   
 $360 \dots\dots\dots 3 + 6 + 0 = 9 \quad \text{and} \quad 360^\circ = (19 - 1)^\circ \times (19 + 1)$
- Perfect Pi =  $19/6 = 3 + (9/54) = 3.1666666 \dots\dots\dots$

## Number – 6 and 19

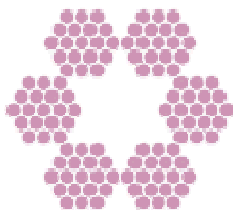


$$6 \times 19 = 114$$

- The total number of Chapters of the Holy Quran are 6 times 19, i.e.  $6 \times 19 = 114$
- The Number – 19 are mentioned 6 times in the Holy Bible.  $6 \times 19 = 114$
- The total number of Sayings of Jesus Christ listed in the Gospel of Thomas is 114.

**Sayings of Jesus Christ in Gospel of Thomas =  $6 \times 19 = 114$**

- 619 is the 114<sup>th</sup> Prime Number
- $6 \times 19 = 114$
- The Volume of the Perfect Sphere is  $6 \times 19 = 114$
- The Surface Area of the Perfect Sphere is  $6 \times 19 = 114$
- The numerical value of the name of Allah, ‘Al-Jami’ meaning the Gatherer is 114, i.e.  $6 \times 19 = 114$ .
- The Arabic word ‘Kul – e – Shai’ meaning Everything is mentioned 114 times in the Holy Quran, i.e.  $6 \times 19 = 114$ .
- There are 6 prime numbers mentioned in the Holy Quran as: 2, 3, 5, 7, 11 and 19. The Number – 19 is the highest prime number mentioned in the Holy Quran.
- The Mandala - 9 of the *Rig-Veda* is comprised of 114 hymns, entirely devoted to Soma Pavamana, the plant of the sacred portion of the Vedic religion, i.e.  $6 \times 19 = 114$ .
- Perfect Pi ( $\pi$ ) = 19 divided by 6 =  $19/6 = 3.1666\dots$
- The Number 13 is the 6<sup>th</sup> Prime Number -----  $13 + 6 = 19$
- The Number – 6 + 6 = 12 is 7<sup>th</sup> Even Number -----  $12 + 7 = 19$
- The square of Number – 14 is:  $14 \times 14 = 196\dots\dots\dots 196\dots\dots\dots 19$  and 6.
- The reversal of Number – 19 is 91. Adding both numbers, we get:  $19 + 91 = 110$  and the Number – 110 is written in Hexadecimal as **6E<sub>16</sub>**.
- The Number 114 is represented by the six fold heart of the sevenfold Logos Star.
- 



$$114 = 6 \times 19$$

## Number – 12 and 19



- Number – 12 is the 7<sup>th</sup> Even Number. Adding 12 and 7, we would get:  $12 + 7 = 19$
- $19 \times 12 = 228$ .....  $2 + 2 + 8 = 12$
- $12 \times 30^\circ = 360^\circ = (19 - 1)^\circ \times (19 + 1)$
- **Perfect Pi** =  $19/6 = 3 + (12/72) = 3.166666$ .....
- $19 + 12 = 31$ .....  $31 \times 31 = 961$  and  $13 \times 13 = 169$ . Both numbers contain same numbers 1, 9 and 6
- $19 - 12 = 7$ ..... 12 is the 7<sup>th</sup> Even Number
- The Arabic name of God is ‘Allah’ and the numeric value of ‘Allah’ is 66. Adding the numbers, we would get ---- **66**..... $6 + 6 = 12$ .....**7<sup>th</sup> Even Number** and  $12 + 7 = 19$ .....the numeric value of name of God ‘Wahid’ meaning One.
- $12 \times 12 = 144$ .....**19<sup>th</sup>** Powerful Number in Mathematics
- $12 \times 3 = 36$ .....**19<sup>th</sup>** Even Number in Mathematics
- 12 Months in a year and 12 is the 7<sup>th</sup> Even Number. So  $12 + 7 = 19$

## Number – 14 and 19



- **19 x 14 = 266..... 2 + 6 + 6 = 14**
- **19 + 14 = 33..... 3 + 3 = 6.....Perfect Diameter of a Perfect Circle or Sphere**
- **19 – 14 = 5.....19 + 6 = 25 = 5 x 5.....square of 5**
- **Number – 14 is the 8<sup>th</sup> Even Number and Number 19 is the 8<sup>th</sup> Prime Number.**
- **Number – 26 is the 14<sup>th</sup> Even Number and 26..... 2 + 6 = 8.....8<sup>th</sup> Prime Number = 19**
- **Number – 27 is the 14<sup>th</sup> Odd Number and 19 is the 8<sup>th</sup> Prime Number. The sum of 19 and 8 is also 27.**
- **Number – 43 is the 14<sup>th</sup> Prime Number. The Number 43..... 4 + 3 = 7 and 7 + 7 = 14. Also Number – 12 is the 7<sup>th</sup> Even Number and 12 + 7 = 19**
- **14 x 14 = 196.....19 and 6.....Perfect Circumference and Perfect Diameter of a Perfect Circle or Sphere**
- **14 + 41 = 55.** The reversal of 55 is also 55. Adding both numbers, we would get – 55 + 55 = 110, which is equal to 110 = 55 + 55 = [(14 + 41) + (41 + 14)] = 19 + 91
- **19 x 6 = 114.....Total Suras in the Holy Quran..... 1 and 14**
- **14 = 2 x 7.... 2 is the 1<sup>st</sup> Prime Number and 7 is the 4<sup>th</sup> Prime Number. So 14 = (1<sup>st</sup> x 4<sup>th</sup>) Prime Numbers**
- **Number – 100 is the 14<sup>th</sup> Powerful Number in mathematics. All Perfect Numbers in mathematics end either with Number – 6 or Number – 8. Adding both the numbers 6 and 8, we would get: 6 + 8 = 14. Now take the squares of the numbers 6 and 8 and then add = (6 x 6) + (8 x 8) = (36) + (64) = 100.....14<sup>th</sup> Powerful Number**
- **36..... 3 + 6 = 9 and 64..... 6 + 4 = 10. Adding 9 and 10, we would get 19**
- **The reversal of the number – 14 is Number 41. The Number – 41 is the 13<sup>th</sup> Prime Number and the Number – 13 is the 6<sup>th</sup> Prime Number----- 13 + 6 = 19**
- **14 + 14 = 28.....2<sup>nd</sup> Perfect Number and 09 + 19 = 28**
- **There are 8 Arabic names of Allah, the sum of the numeric value of those 8 names of Allah is 14 and Number – 19 is the 8<sup>th</sup> Prime Number.**
- **Perfect Pi = 2 + (14/12) = 19/6 = 3.166666.....**



## Gregorian – Hijri Calendars, Real Pi and 19



The year is the period taken by the Earth to complete an orbit around the Sun and, again, there are a number of ways in which this can be measured. But for calculating a calendar that is to remain in step with the seasons, it is most convenient to use the tropical year, since this refers directly to the Sun's apparent annual motion. The tropical year is defined as the interval between successive passages of the Sun through the vernal equinox (i.e., when it crosses the celestial equator late in March) and amounts to 365.242199 mean solar days.

The tropical year and the synodic month (lunar month) are incommensurable, 12 synodic months amounting to 354.36706 days, almost 11 days shorter than the tropical year.

The Muslim Era is computed from the starting point of the year of the emigration (Hijri); that is, from the year in which Muhammad, the Prophet of Islam, emigrated from Mecca to Medina, AD 622. The first day of the month Muharram which is the beginning of the year was set as:

**1<sup>st</sup> Muharram, Hijri = July 16, 622 (Friday)**

The years of the Muslim calendar are lunar and always consist of 12 (lunar) months, each month beginning approximately at the time of the New Moon. The months are alternately 30 and 29 days long except for the 12<sup>th</sup> Islamic month, Dhu al-Hijjah, the length of which is varied in a 30-year cycle intended to keep the calendar in step with the true phases of the Moon. In 11 years of this cycle, Dhu al-Hijjah has 30 days, and in the other **19 years** it has 29. Thus the year has either 354 or 355 days. No months are intercalated, so that the named months do not remain in the same seasons but retrogress through the entire solar, or seasonal, year (of about 365.25 days) every 32.5 solar years.

Now the following equation shows the in time relation between the Islamic year, the Gregorian year and the **perfect rational magical number  $\text{Pi} = 19/6 = 3.166666\dots$** .... It's to say that also history and dates are mathematically linked to each other. The conversion is usually made by special software. Try the below equation to see the accuracy of the results and control the precision with a Hijri/Gregorian converter.

(Reference: <http://www.answering-christianity.com/fakir60/calendar.htm>)

**622 AD is the year of Hijri.**

**If you are in the second half of the year use 622  
Use 622.5 if you are in the first half of the year**

**Perfect Pi = 19/6 = 3.1666666.....**

### **Mysterious Formula – Conversion of Gregorian calendar to Hijri calendar**

**1. For the second half of the Gregorian year**

$$\mathbf{(Gregorian - 622) \times (Pi/100 + 1) = Hijri Year}$$

**2. For the first half of the Gregorian year**

$$\mathbf{(Gregorian - 622.5) \times (Pi/100 + 1) = Hijri Year}$$

**Where Pi = 19/6**

**Illustration:**

*Gregorian Month and Year – October, 2010. Convert to Hijri year*

**For the second half of the Gregorian year**

$$\mathbf{(Gregorian - 622) \times (Pi/100 + 1) = Hijri Year}$$

$$\mathbf{= (2010 - 622) \times [(19/ (6 \times 100)) + (1)]}$$

$$\mathbf{= 1431.95 .....Hijri Year}$$

**1431 Hijri and 0.95....indicate that 1431 Hijri year is at the end because next Hijri year would start on 8<sup>th</sup> December, 2010 (1<sup>st</sup> Muharram, 1432 Hijri).**

## Chemistry and 19



“Both the chemistry as well as the physics are material sciences, even natural sciences, that till now differs from the immaterial sciences or humanities. The chemistry deals more with the elements as well as materials, from which the Earth is made up, whereas the physics deals with energies and (complex) bodies that have been composed from these elements and materials.

While for the chemistry the analysis of the components of substances and the creation of synthetic materials of decisive meaning is, the physics deals with laws, which bodies and energies are subject to.

One of the important differentiation of the chemistry, is the organic and inorganic substances, the two building materials of the Universe. On the other hand, to the important measurement-research of the physics belongs the Time, the Room and the Movement, through which physical objects define themselves in their existence.

For centuries, the scientists had essentially devoted time to the outer behavior of bodies and materials. Only in the course of the last century, increased efforts were undertaken, to explore atomic and subatomic structures of all Earth's material manifestations. From this are the nuclear physics and nuclear chemistry originated.

Within these physical and chemical nuclear-sciences, one has discovered that no more than only three observable particles, which in interplay form the matter: protons, neutrons and electrons. One could determine that protons has a positive electric charge, and the electrons a negative charge. While by neutrons is apparently missing every sort of charge, thus their name.

Neutrons and protons form together the atomic nucleus. Whereas electrons normally whirl around in the atomic cosmos, and only, if they come into the proximity of an atomic nucleus, sit up like "sparrows on wires" (Dr. Peter Plichta) around the atomic shells on the atomic nucleus. If it becomes them too hot, they begin to "jump" and vanish again.

Neutrons can likewise, also leave the atomic nucleus - in which each one is disintegrated into an electron and proton. Until now, differently than the nuclear-scientists and theoretical physicists, Peter Plichta, like Arnold Sommerfeld, supposed that some structural phenomenon of the nuclear construction of the matter have to do with the numbers theory and it could led back on quite simple formulas and knowledge. Had not Albert Einstein predicted that a future physics will born without complicated formulas and

lead to quite simple numbers-relation? Since then, Plichta is tormented, and if it is true then the entire Science will collapse in a day like a house of cards.

In this moment, he just remembered his earlier chemical and biochemical knowledge. Already as chemistry-student, he had noticed that each earthly life is built on 19 left built amino acids and an amino acid without optical center, (therefore neither left-nor right-built).

As Hamlet from Shakespeare is also composed out of only nineteen consonants. Others than these nineteen + one amino acids can be produced only artificially, thus they never appear as natural product. Amino acids are not only vital but also a life-requirement, since they make enzymes and proteins, which are our basis of life. The German chemist wondered quite nervously why God has decided exactly in favor of 19+1 amino acids? How would he be able to know also, that all great traditions transmitted the number 19 as number of the Life?"

(Reference: <http://www.answering-christianity.com/fakir60/chemistry.htm>)

Dr. Peter Plichta, a renowned German chemist, physicist and biologist has run into number 19 frequently during his search for 'God's secret formula.' He asked himself, 'does this remarkable number have a similar outstanding meaning for the Nature, in which we live, and for the material conception of the world?

Dr. Peter Plichta



The response that Dr. Peter Plichta discovered after years of great struggle, is 'Yes'. Dr. Plichta realized through his work that chemistry, physics and biology and their derivatives for e.g. biochemistry are all together connected to the number 19. It is the **SECRET CODE**, which helps the Nature in its organizations and structures.

1 H																	2 He														
3 Li	4 Be											5 B	6 C	7 N	8 O	9 F	10 Ne														
11 Na	12 Mg											13 Al	14 Si	15 P	16 S	17 Cl	18 Ar														
19 K	20 Ca	21 Sc	22 Ti	23 V	24 Cr	25 Mn	26 Fe	27 Co	28 Ni	29 Cu	30 Zn	31 Ga	32 Ge	33 As	34 Se	35 Br	36 Kr														
37 Rb	38 Sr	39 Y	40 Zr	41 Nb	42 Mo	43 Tc	44 Ru	45 Rh	46 Pd	47 Ag	48 Cd	49 In	50 Sn	51 Sb	52 Te	53 I	54 Xe														
55 Cs	56 Ba	57 La	58 Ce	59 Pr	60 Nd	61 Pm	62 Sm	63 Eu	64 Gd	65 Tb	66 Dy	67 Ho	68 Er	69 Tm	70 Yb	71 Lu	72 Hf	73 Ta	74 W	75 Re	76 Os	77 Ir	78 Pt	79 Au	80 Hg	81 Tl	82 Pb	83 Bi	84 Po	85 At	86 Rn
87 Fr	88 Ra	89 Ac	90 Th	91 Pa	92 U	93 Np	94 Pu	95 Am	96 Cm	97 Bk	98 Cf	99 Es	100 Fm	101 Md	102 No	103 Lr	104 Rf	105 Db	106 Sg	107 Bh	108 Hs	109 Mt	110 Uun								

58 Ce	59 Pr	60 Nd	61 Pm	62 Sm	63 Eu	64 Gd	65 Tb	66 Dy	67 Ho	68 Er	69 Tm	70 Yb	71 Lu
90 Th	91 Pa	92 U	93 Np	94 Pu	95 Am	96 Cm	97 Bk	98 Cf	99 Es	100 Fm	101 Md	102 No	103 Lr

### The Chemical Elements

This page describes the mystery of 19 according to the theories of Peter Plichta as set out in his book "God's Secret Formula".

**There are 81 stable Chemical Elements.**

Potassium (19)			
Beryllium (4)	Helium (2)	Carbon (6)	Lithium (3)
<b>Single Isotope</b> <small>(atomic numbers are odd)</small>	<b>Double Isotopes</b> <small>(atomic numbers are odd)</small>	<b>Multiple Isotopes</b> <small>(atomic number divisible by 4)</small>	<b>Multiple Isotopes</b> <small>(atomic number divisible by 2)</small>
Fluorine (9)	Hydrogen (1)	Oxygen (8)	Neon (10)
Phosphorus (15)	Boron (5)	Magnesium (12)	Silicon (14)
Scandium (21)	Nitrogen (7)	Nickel (28)	Argon (18)
Manganese (25)	Chlorine (17)	Germanium (32)	Titanium (22)

Cobalt (27)	Vanadium (23)	Zirconium (40)	Zinc (30)
Arsenic (33)	Copper (29)	Ruthenium (44)	Tungsten (74)
Yttrium (39)	Gallium (31)	Barium (56)	Molybdenum (42)
Rhodium (45)	Rubidium (37)	Neodymium (60)	Samarium (62)
Caesium (55)	Silver (47)	Gadolinium (64)	Dysprosium (66)
Terbium (65)	Lutetium (71)	Osmium (76)	Ytterbium (70)
Thulium (69)	Tantalum (73)	Mercury (80)	Xenon (54)
Sodium (11)	Bromine (35)	Sulfur (16)	Iron (26)
Aluminum (13)	Indium (49)	Chromium (24)	Strontium (38)
Niobium (41)	Antimony (51)	Calcium (20)	Cerium (58)
Iodine (53)	Lanthanum (57)	Krypton (36)	Lead (82)
Praseodymium (59)	Europium (63)	Erbium (68)	Selenium (34)
Holmium (67)	Rhenium (75)	Hafnium (72)	Palladium (46)
Gold (79)	Iridium (77)	Cadmium (48)	Platinum (78)
Bismuth (83)	Thallium (81)	Tellurium (52)	Tin (50)

The table above shows an amazing mathematical order. It divides the building blocks of Nature into 4 x 19 chemical elements, where four elements (Beryllium, Helium, Carbon and Lithium), are set above in a super-order. Over them all, sits outstanding, the key-number of this whole system, **the number 19, which represents Potassium**. The whole system is structured on the **number 19**.

### **Of the 81 stable elements:**

The total number of pure isotopes is exactly 20.

The total number of double isotopes is exactly 20.

The total number of multiple isotopes divisible by 2 is 20.

The total number of multiple isotopes divisible by 4 is 20.

The largest Neutron number for any stable isotope=209=11x **19**.

$$209 = 11 \times 19$$

From unstable element 43 to unstable element 61 inclusively we have **19** elements.

The total neutron number for all the stable isotopes=30704=1616 x **19**.

$$30704 = 19 \times 1616$$

The **total electron number** for all the stable elements=1+2+3...83-(43+61) = 3382 = 178 x **19**.

$$3382 = 19 \times 178$$

Therefore the **total proton number** for all the stable elements also=1+2+3...83-(43+61)=3382.

$$3382 = 19 \times 178$$

The addition of the above 3 totals=37468 = **19** x 1972.

$$37468 = 19 \times 1972$$

He noticed that each earthly life is built on **19 left-built amino acids** and an amino acid without optical center, just as the Hamlet Shakespeare is composed also from only 19 consonants. Amino acids are not only vital but a life requirement, since they form enzymes and proteins, that are our life-bases. The Duesselderfer chemist wondered why God has decided exactly in favor of 19 + 1 amino acids? How would He be able to know also, that all great traditions have passed on the number 19 as the number of life?

Dr. Peter Plichta described that there are actually only 81 natural existing stable elements. From 83 theoretically possible elements, only 81 occur in the Nature. Then the scientist found out that from these 81 natural occurring stable elements of the Chemistry, 19 are pure isotopes. Pure isotopes are chemical elements that exist only in one isotope form, that is to say that occurs with same number of protons and neutrons.

With astonishment, the chemist noticed that all pure isotopes are elements with *odd atomic numbers in the periodic table*. The 19 pure isotopes with odd atomic numbers in the periodic table are:



**9, 11, 13, 15, 21, 25, 27, 33, 39, 41, 45, 53, 59, 65, 67, 69, 79, 83 ----- 19 isotopes**

He also found out that the number of the double isotopes is also 19 with odd atomic number, that is to say that elements with two ‘mass numbers’ or isotopes.

He further noticed that there are **38 multiple isotopes (19 x 2 = 38)** with even atomic numbers.

### *The Stable Isotopes*

Element	1	2	3	4	5	6	7	8	9	10	Total
Hydrogen	1	2	-	-	-	-	-	-	-	-	<b>3</b>
Helium	3	-	-	-	-	-	-	-	-	-	<b>3</b>
Lithium	6	7	-	-	-	-	-	-	-	-	<b>13</b>
Beryllium	9	-	-	-	-	-	-	-	-	-	<b>9</b>
Boron	10	11	-	-	-	-	-	-	-	-	<b>21</b>
Carbon	12	13	-	-	-	-	-	-	-	-	<b>25</b>
Nitrogen	14	15	-	-	-	-	-	-	-	-	<b>29</b>
Oxygen	16	17	18	-	-	-	-	-	-	-	<b>51</b>
Fluorine	19	-	-	-	-	-	-	-	-	-	<b>19</b>
Neon	21	22	-	-	-	-	-	-	-	-	<b>43</b>
Sodium	23	-	-	-	-	-	-	-	-	-	<b>23</b>
Magnesium	24	25	26	-	-	-	-	-	-	-	<b>75</b>
Aluminum	27	-	-	-	-	-	-	-	-	-	<b>27</b>
Silicon	28	29	30	-	-	-	-	-	-	-	<b>87</b>
Phosphorus	31	-	-	-	-	-	-	-	-	-	<b>31</b>
Sulfur	32	33	34	36	-	-	-	-	-	-	<b>135</b>
Chlorine	35	37	-	-	-	-	-	-	-	-	<b>72</b>
Argon	36	38	40	-	-	-	-	-	-	-	<b>114</b>
Potassium	39	40	41	-	-	-	-	-	-	-	<b>120</b>
Calcium	40	42	43	44	46	48	-	-	-	-	<b>263</b>
Scandium	45	-	-	-	-	-	-	-	-	-	<b>45</b>
Titanium	46	47	48	49	50	-	-	-	-	-	<b>240</b>
Vanadium	50	51	-	-	-	-	-	-	-	-	<b>101</b>
Chromium	50	52	53	54	-	-	-	-	-	-	<b>209</b>
Manganese	55	-	-	-	-	-	-	-	-	-	<b>55</b>
Iron	54	56	57	58	-	-	-	-	-	-	<b>225</b>
Cobalt	59	-	-	-	-	-	-	-	-	-	<b>59</b>
Nickel	58	60	61	62	64	-	-	-	-	-	<b>305</b>
Copper	63	65	-	-	-	-	-	-	-	-	<b>128</b>



Zinc	64	66	67	68	70	-	-	-	-	-	<b>335</b>
Gallium	69	71	-	-	-	-	-	-	-	-	<b>140</b>
Germanium	72	73	74	76	-	-	-	-	-	-	<b>295</b>
Arsenic	75	-	-	-	-	-	-	-	-	-	<b>75</b>
Selenium	74	76	77	78	80	82	-	-	-	-	<b>467</b>
Bromine	79	81	-	-	-	-	-	-	-	-	<b>160</b>
Krypton	78	80	82	83	84	86	-	-	-	-	<b>493</b>
Rubidium	85	87	-	-	-	-	-	-	-	-	<b>172</b>
Strontium	84	86	87	88	-	-	-	-	-	-	<b>345</b>
Yttrium	89	-	-	-	-	-	-	-	-	-	<b>89</b>
Zirconium	90	91	92	94	96	-	-	-	-	-	<b>463</b>
Niobium	93	-	-	-	-	-	-	-	-	-	<b>93</b>
Molybdenum	92	94	95	96	97	98	100	-	-	-	<b>672</b>
Ruthenium	96	98	99	100	101	102	104	-	-	-	<b>700</b>
Rhodium	96	-	-	-	-	-	-	-	-	-	<b>96</b>
Palladium	102	104	105	106	108	110	-	-	-	-	<b>635</b>
Silver	107	109	-	-	-	-	-	-	-	-	<b>216</b>
Cadmium	106	108	110	111	112	113	114	116	-	-	<b>790</b>
Indium	113	115	-	-	-	-	-	-	-	-	<b>228</b>
Tin	112	114	115	116	117	118	119	120	122	124	<b>1177</b>
Antimony	121	123	-	-	-	-	-	-	-	-	<b>244</b>
Tellurium	120	122	123	124	126	128	130	-	-	-	<b>873</b>
Iodine	127	-	-	-	-	-	-	-	-	-	<b>127</b>
Xenon	124	126	128	129	130	131	132	134	136	-	<b>1170</b>
Caesium	133	-	-	-	-	-	-	-	-	-	<b>133</b>
Barium	130	132	134	135	136	137	138	-	-	-	<b>942</b>
Lanthanum	138	139	-	-	-	-	-	-	-	-	<b>277</b>
Cerium	136	138	140	142	-	-	-	-	-	-	<b>556</b>
Praseodymium	141	-	-	-	-	-	-	-	-	-	<b>141</b>
Neodymium	142	143	144	145	146	148	150	-	-	-	<b>1018</b>
Samarium	144	147	148	149	150	152	154	-	-	-	<b>1044</b>
Europium	151	153	-	-	-	-	-	-	-	-	<b>304</b>
Gadolinium	152	154	155	156	157	158	160	-	-	-	<b>1092</b>
Terbium	159	-	-	-	-	-	-	-	-	-	<b>159</b>
Dysprosium	156	158	160	161	162	163	164	-	-	-	<b>1124</b>
Holmium	165	-	-	-	-	-	-	-	-	-	<b>165</b>
Erbium	162	164	166	167	168	170	-	-	-	-	<b>997</b>
Thulium	169	-	-	-	-	-	-	-	-	-	<b>169</b>
Ytterbium	168	170	171	172	174	176	-	-	-	-	<b>1031</b>
Lutetium	175	176	-	-	-	-	-	-	-	-	<b>351</b>

Hafnium	174	176	177	178	179	180	-	-	-	-	<b>1064</b>
Tantalum	180	181	-	-	-	-	-	-	-	-	<b>361</b>
Tungsten	180	182	183	184	186	-	-	-	-	-	<b>915</b>
Rhenium	185	187	-	-	-	-	-	-	-	-	<b>372</b>
Osmium	184	186	187	188	189	190	192	-	-	-	<b>1316</b>
Iridium	191	193	-	-	-	-	-	-	-	-	<b>384</b>
Platinum	190	192	194	195	196	198	-	-	-	-	<b>1165</b>
Gold	197	-	-	-	-	-	-	-	-	-	<b>197</b>
Mercury	196	198	199	200	201	202	204	-	-	-	<b>1400</b>
Thallium	203	205	-	-	-	-	-	-	-	-	<b>408</b>
Lead	204	206	207	208	-	-	-	-	-	-	<b>825</b>
Bismuth	209	-	-	-	-	-	-	-	-	-	<b>209</b>
81 Stable	-	-	-	-	-	-	-	-	-	-	<b>30704</b>

30704=**19** x 1616

3382 =**19** x 178

3382 =**19** x 178

37468=**19** x 1972

Dr. Peter Plichta had reached a crucial breakthrough. In his own words,

He says:

**“I understand that nature strictly divided the stable elements according to the type of their divisibility in four nineteenth columns. It assigned a twentieth number to each of the four categories, that stands in the table over this nineteen numbers, without violating the ‘Nineteen rule’ which regulates the divisibility. The coding effect of the number 19 is distinct and clear. The whole system is subject to one 19-Code system.”**

The biochemical components of life, the amino acids are coded by the number 19. The structure of the 81 stable, natural existing chemical elements, the components of the Nature are in many ways subject to the same code.

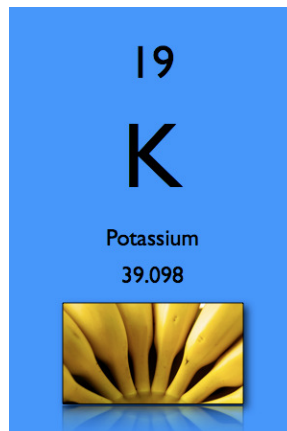
**“A lonely number, the unique number 19, proves to be the King of the Chemistry.”**

## 19 – God’s Secret Formula and Chemistry Facts:



- The largest Neutron number for any stable isotope = **209 = 11 x 19**.
- From unstable element 43 to unstable element 61 inclusively, we have 19 elements.
- The total neutron number for all stable isotopes = 30704 = **19 x 1616**
- The total electron number for all the stable elements = 3382 = **19 x 178**
- The total proton number for all the stable elements also = 3382 = **19 x 178**
- If we add the total neutron numbers, the electron numbers and the proton numbers, we would get: 37468 = **19 x 1972**
- The atomic number of Potassium is 19.

(Reference: <http://www.plichta.de>)



## Computer Science and 19



$$19 = 1 + 9 = 10 = 1 + 0 = 01$$

$$19 = 01$$

We all know that the language of the Computer Sciences is 0 and 1. Whatever we write or draw or take picture or do anything on computer in any language, the computer only understands and interprets into its own language of 0 and 1.

Secondly, all the information in the Computers is stored in bits and bytes. The **byte** is a unit of digital information in computing and telecommunications, that most commonly consists of eight bits. Historically, a byte was the number of bits used to encode a single character of text in a computer and it is for this reason the basic addressable element in many computer architectures.

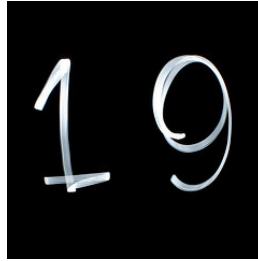
In general, the size of a byte may be hardware dependent, as no definitive standards exist that mandate its size. The modern de facto standard of eight bits is a convenient power of two permitting the values 0 through 255 for one byte.

Each byte consists a combination of 8 bits of 0 and 1.



Now we know that  $19 = 01$  and 19 is the 8<sup>th</sup> Prime Numbers. So whatever data or information we are exchanging on computers today is only 0 and 1 and the root of 0 and 1 is 19. Even the numbers of bits in a 'Byte' are also 8 as 19 is the 8<sup>th</sup> Prime Number. Is it a coincidence that our modern technology of Computers and the language of Computers is also indicating the secret messages of Number – 19 and its mathematical properties.

## Medical Science and 19



### Length of Pregnancy and 19:

'Langman's Medical Embryology' by T.W. Sadler, is used as a textbook in most of the Medical Schools in the USA. On page 88 of the Fifth edition, it is written: "In general the length of pregnancy for a full term fetus is considered to be 280 days or 40 weeks after onset of the last menstruation, or more accurately, 266 days or 38 weeks after fertilization."

The numbers 266 and 38 are both multiples of 19.

$$266 \text{ days} = 19 \times 14 \dots\dots\dots\text{A}$$

$$266 \text{ days} = 38 \text{ weeks} \dots\dots\dots\text{B}$$

$$38 = 19 \times 2 \dots\dots\dots\text{C}$$

$$38 \text{ weeks} = 19 \times 2 \times 7 = 266 \text{ days} \dots\dots\dots\text{D}$$

### Human Bones in a new born baby and 19:

It is medically accepted all over the world that the average number of bones in a new born baby are 209.

**Average Number of Bones in a New Born Baby = 209**

$$209 = 19 \times 11$$

$$209 \text{ Bones in a new born baby} = 19 \times 11$$

## Human Hand and 19:

The Human Hand has 19 bones. We have 14 bones in our 5 fingers and 5 bones in the palm of our hand.



**Human Hand = 19 Bones**

$$19 = 19 \times 1$$

- The median height of the new born babies (boys and girls) is **19 inches** as documented and recorded in medical science.

**Average Height of a New Born Baby = 19 inches**

- Every square inch of the human body has about **19 million** skin cells.

**Every Square Inch of human body = 19 million skin cells**

(Reference: <http://www.kidskonnnect.com/subject-index/31-health/337-human-body.html>)

- It takes about **57 to 76 seconds** for the blood cell to circle the whole body when we are resting as a range because it differs from person to person.

$$57 = 19 \times 3 \text{ and } 76 = 19 \times 4$$

57 and 76 when written as a single number as:

$$5776 \dots \dots \dots 19 \times 304 = 5776 \text{ and } 304 = 19 \times 16$$

$$5776 \dots \dots \dots 19 \times 16 \times 19$$

# Body Systems and 19

There are 12 major Body Systems in the human body:

1. **Circulatory System** (heart, blood, vessels)
2. **Respiratory System** (nose, trachea, lungs)
3. **Immune System** (many types of protein, cells, organs, tissues)
4. **Skeletal System** (bones)
5. **Excretory System** (lungs, large intestine, kidneys)
6. **Urinary System** (bladder, kidneys)
7. **Muscular System** (muscles)
8. **Endocrine System** (glands)
9. **Digestive System** (mouth, esophagus, stomach, intestines)
10. **Nervous System** (brain, spinal cord, nerves)
11. **Reproductive System** (male and female reproductive organs)
12. **Integumentary System** (skin and tissues)

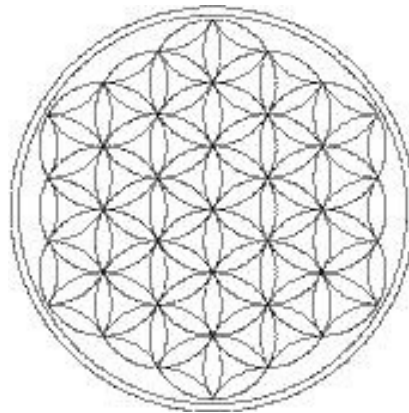
Number – 12 is the 7<sup>th</sup> Even Number. Adding 12 and 7, we would get:

12 Body Systems -----12-----7<sup>th</sup> Even Number-----12 + 7 = 19

$$12 + 7 = 19$$

## Flower of Life Symbol and 19:

**The flower of life symbol consists of 19 interlocking circles.**





# Creation of Humans and 19

Number 19 in The Creation of Humans

We can notice from pondering upon the creation of Allah (God) of the human body that He arranged hairs and muscular filaments in a hexagonal pattern as shown in figures 1 and 2.



Figure 1: Hexagonal arrangement of hairs in skin.

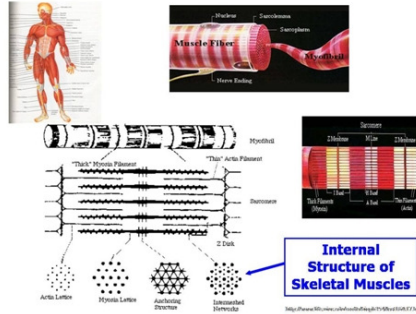


Figure 2: Hexagonal pattern of filaments in muscles.

And we can also notice that the hexagonal arrangement of photons in energy are identical from a design perspective to the number 19 when represented from a mathematical perspective, as shown in figures 2 and 3.

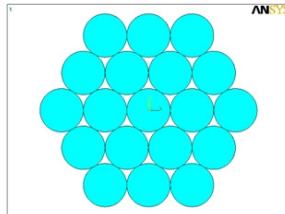


Figure 3: The representation of the number 19 from a mathematical perspective.

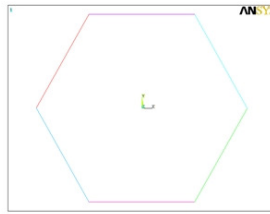


Figure 4: The hexagonal geometry resulting from the number 19 when represented mathematically.

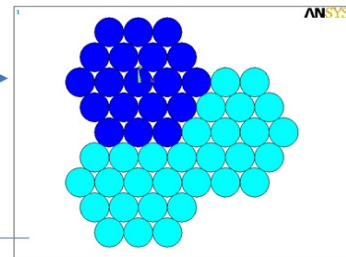
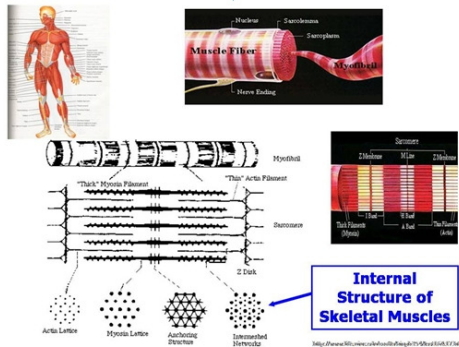
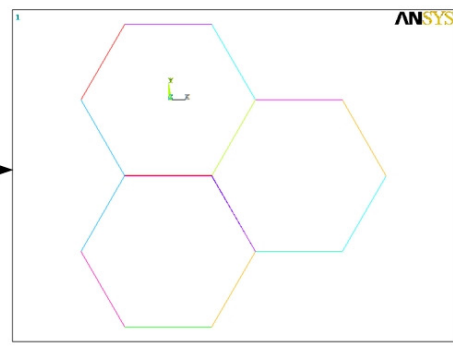


Figure 5: Hexagonal arrangements resulting from the multiplication of the number 19.



The equation of creation = Multiple units of 19 =  $19 * 19 * 19 * \dots = 19 * n$  (where n = number of units of 19)



Hexagonal units resulting from the assembly of number 19 units =  $19 * 19 * 19 * \dots$

(Reference: Dr. Zaid Kasim Ghazzawi – [www.quran-miracle.com](http://www.quran-miracle.com))

## Astral Body and 19



**The 'astral body' is said to be composed of 19 elements:**

1. Intelligence
2. Ego
3. Feeling
4. Mind

**Five Senses:**

1. Sight
2. Hearing
3. Smell
4. Taste
5. Touch

**Five Instruments of Action:**

1. Mental correspondence for the executive abilities to procreate
2. Excrete
3. Talk
4. Walk
5. Exercise manual skill.

**Five Instruments of Life Force:**

1. Empowered to perform the crystallizing
2. Assimilating
3. Eliminating
4. Metabolizing
5. Circulating functions of the body.

This subtle astral encasement of 19 elements survives the death of the physical body.

(Quoted from 'Autobiography of a Yogi' by Paramhansa Yogananda)

## Chakra Levels and 19

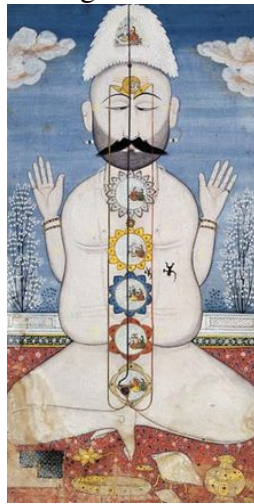


Anodea Judith (1996: p. 5) provides a modern interpretation of the chakras:

“A chakra is believed to be a center of activity that receives, assimilates, and expresses life force energy. The word *chakra* literally translates as *wheel* or *disk* and refers to a spinning sphere of bio-energetic activity emanating from the major nerve ganglia branching forward from the spinal column. Generally, six of these wheels are described, stacked in a column of energy that spans from the base of the spine to the middle of the forehead, the seventh lying beyond the physical world. It is the **six major chakras** that correlate with basic states of consciousness...”

**It is said that there are basically 19 Main Chakra levels**

The **base Chakra** has been the **7<sup>th</sup>** and the **Crown Chakra** being the **13<sup>th</sup>**. So there are **3 sets of 7** which share **Chakras 7 and 13**, so that **7 Chakras x 3 sets = 21 Chakras** are actually 19 Chakras. The 3 levels correspond with the 3 gunas.



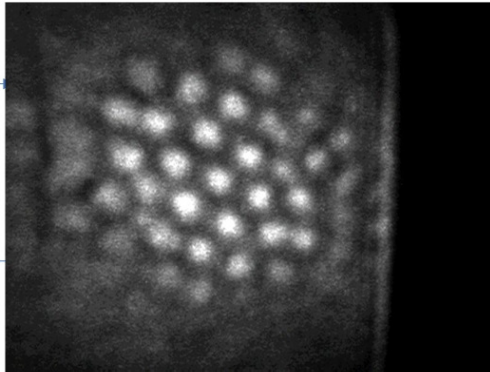
(Reference: <http://en.wikipedia.org/wiki/Chakra>)

**“If God speaks to man, he undoubtedly uses the language of mathematics.”**  
**-Henri Poincare**

# Energy and 19

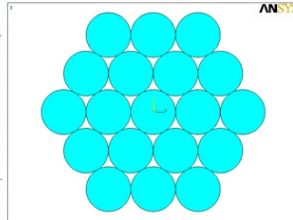
## Number 19 in The Creation of Energy

We can notice from pondering upon the creation of Allah (God) of energy in creation (like light energy for example) that He arranged the units comprising the energy field (i.e. photons) in a hexagonal pattern as shown in figure 1.

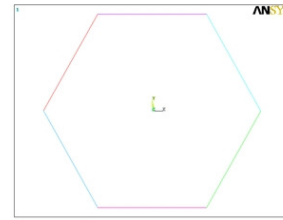


**Figure 1:** Hexagonal arrangement of units comprising light energy (i.e. Photons)

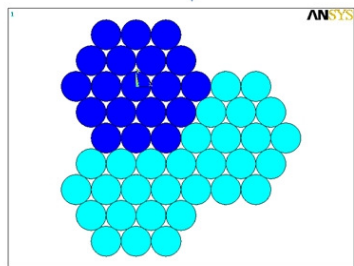
And we can also notice that the hexagonal arrangement of photons in energy are identical from a design perspective to the number 19 when represented from a mathematical perspective, as shown in figures 2 and 3.



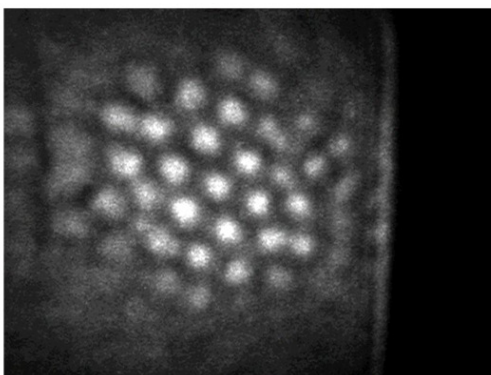
**Figure 2:** The representation of the number 19 from a mathematical perspective.



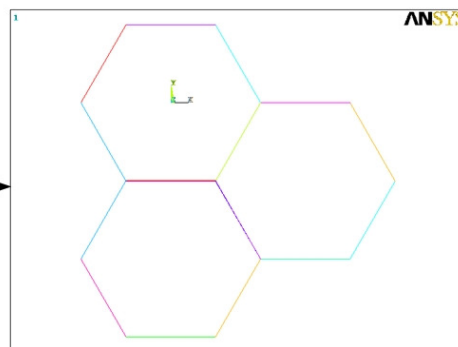
**Figure 3:** The hexagonal geometry resulting from the number 19 when represented mathematically.



**Figure 4:** Hexagonal arrangements resulting from the multiplication of the number 19.



**The equation of creation** = Multiple units of 19 =  $19 * 19 * 19 * \dots = 19 * n$  (where n = number of units of 19)



Hexagonal units resulting from the assembly of number 19 units =  $19 * 19 * 19 * \dots$

(Reference: Dr. Zaid Kasim Ghazzawi – [www.quran-miracle.com](http://www.quran-miracle.com))

# Plants and 19

Number 19 in The Creation of Plants

We can notice from pondering upon the creation of Allah (God) for wood material that wood is composed of hexagonal cells as shown in figure 1.

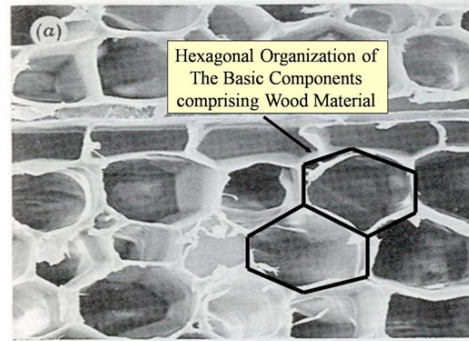


Figure 1: The hexagonal design of wood material.

And we also notice that the hexagonal cells making wood material are identical from a design perspective to the number 19 when represented from a mathematical perspective, as shown in figures 2 and 3.

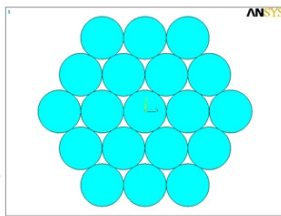


Figure 2: The representation of the number 19 from a mathematical perspective.

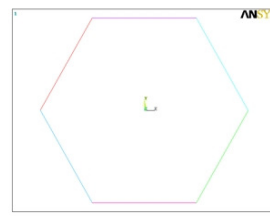


Figure 3: The hexagonal geometry resulting from the number 19 when represented mathematically.

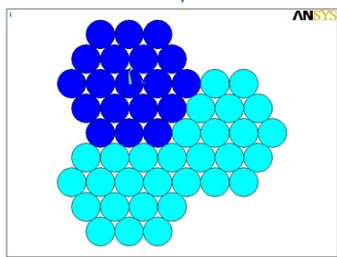
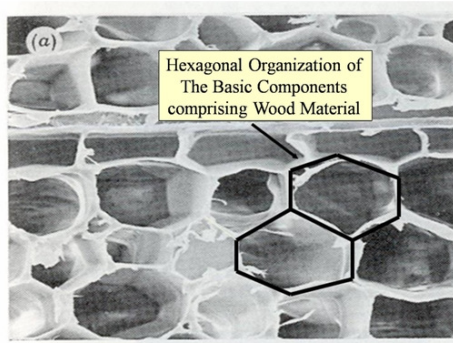
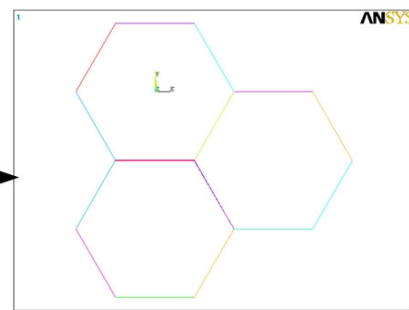


Figure 4: Hexagonal arrangements resulting from the multiplication of the number 19.



The equation of creation = Multiple units of 19 =  $19 * 19 * 19 * \dots = 19 * n$  (where n = number of units of 19)



Hexagonal units resulting from the assembly of number 19 units =  $19 * 19 * 19 * \dots$

(Reference: Dr. Zaid Kasim Ghazzawi – [www.quran-miracle.com](http://www.quran-miracle.com))



# Insects and 19

## Number 19 in The Creation of Insects

We can notice from pondering upon the creation of Allah (God) for the eyes of the insects that Allah (God) designed these eyes with hexagonal cells as shown in figure 1.

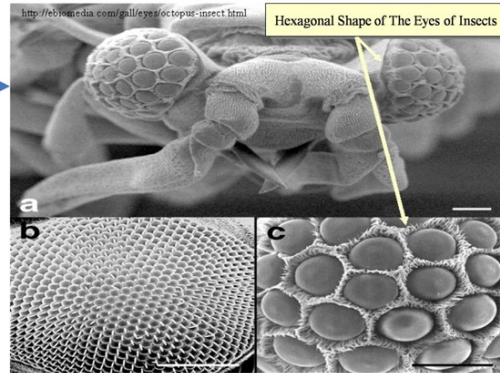


Figure 1: Hexagonal cells comprising the eyes of insects.

And we also notice that the hexagonal cells making the eyes of insects are identical from a design perspective to the number 19 when represented from a mathematical perspective, as shown in figures 2 and 3.

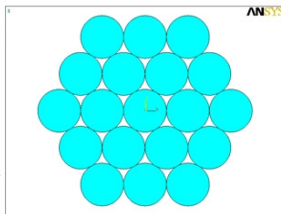


Figure 2: The representation of the number 19 from a mathematical perspective.

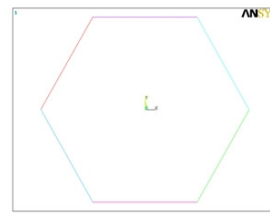


Figure 3: The hexagonal geometry resulting from the number 19 when represented mathematically.

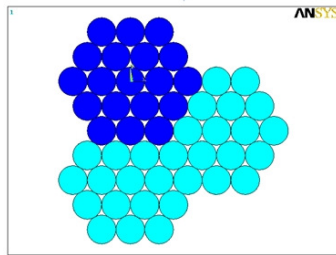
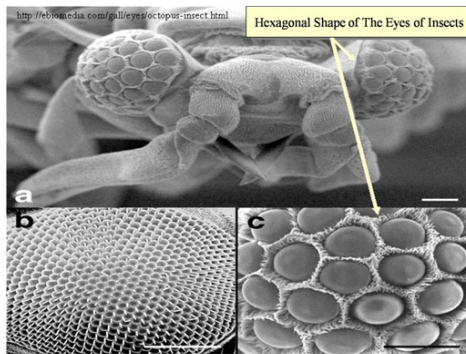
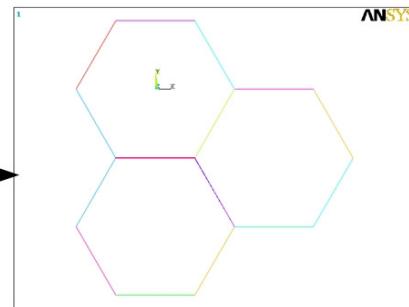


Figure 4: Hexagonal arrangements resulting from the multiplication of the number 19.



The equation of creation = Multiple units of 19 =  $19 * 19 * 19 * \dots = 19 * n$  (where n = number of units of 19)



Hexagonal units resulting from the assembly of number 19 units =  $19 * 19 * 19 * \dots$

(Reference: Dr. Zaid Kasim Ghazzawi – [www.quran-miracle.com](http://www.quran-miracle.com))

# Matter and 19

Number 19 in The Creation of Matter

We can notice from pondering upon the creation of Allah (God) of matter in creation (like Silica for example) that He arrangement the atoms in a hexagonal pattern as shown in figure 1.

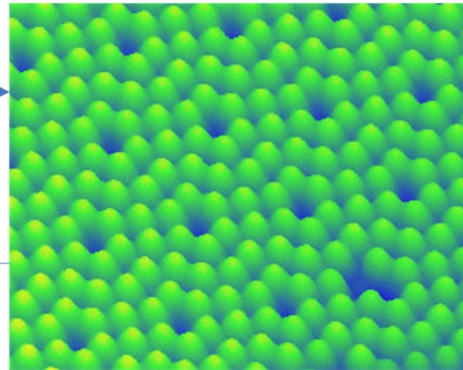


Figure 1: Hexagonal arrangement of Silica atoms.

And we can also notice that the hexagonal arrangement of atoms in matter are identical from a design perspective to the number 19 when represented from a mathematical perspective, as shown in figures 2 and 3.

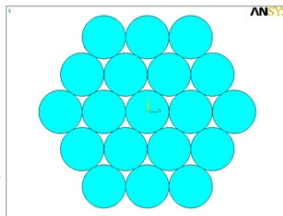


Figure 2: The representation of the number 19 from a mathematical perspective.

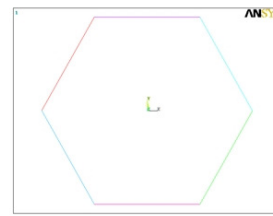


Figure 3: The hexagonal geometry resulting from the number 19 when represented mathematically.

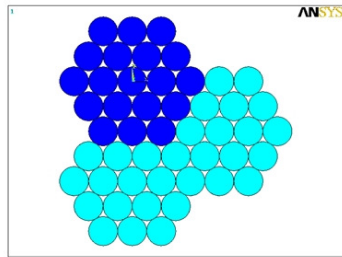
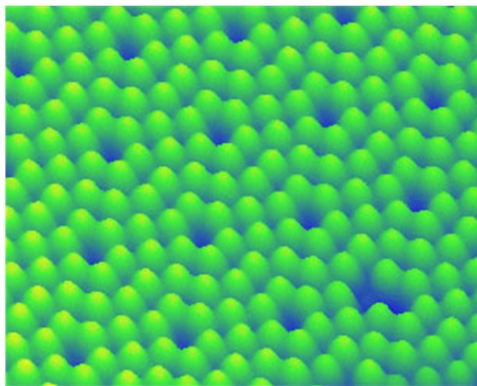
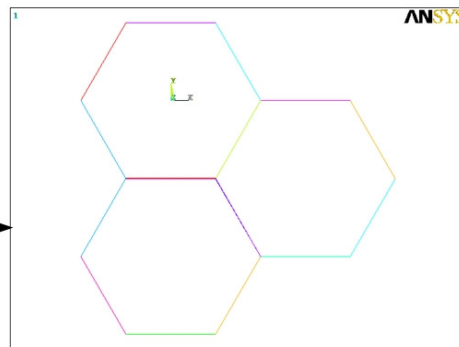


Figure 4: Hexagonal arrangements resulting from the multiplication of the number 19.



The equation of creation = Multiple units of 19 =  $19 * 19 * 19 * \dots = 19 * n$  (where n = number of units of 19)



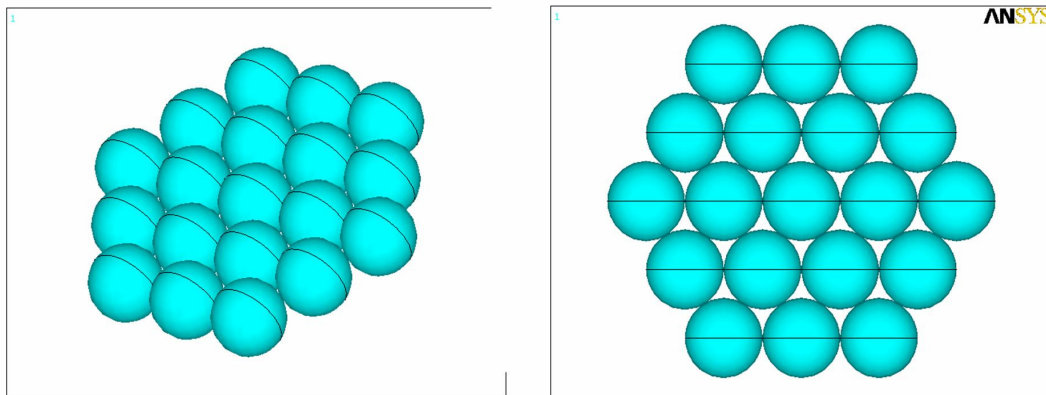
Hexagonal units resulting from the assembly of number 19 units =  $19 * 19 * 19 * \dots$

(Reference: Dr. Zaid Kasim Ghazzawi – [www.quran-miracle.com](http://www.quran-miracle.com))

## Engineering and 19



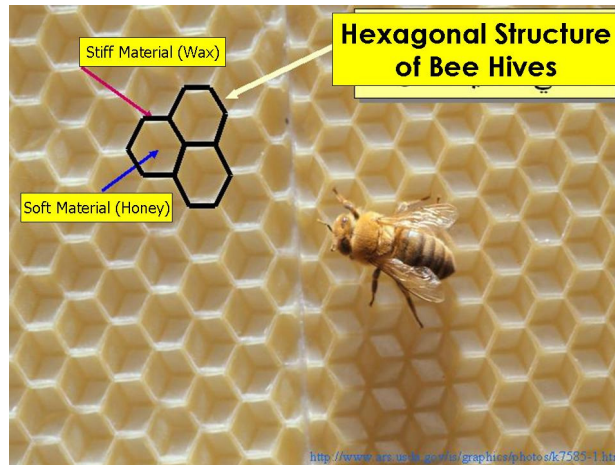
The research work done by Dr. Zaid Kasim Mohammad Ghazzawi shows that 19 again plays a pivotal role in the field of Engineering. He explained that the Number – 19 can be represented by 19 spheres and the most stable configuration for these spheres is a hexagonal pattern as shown in figure – 1



*Figure (1): Number 19 representation from a mathematical point of view*

He explained that if we look at the design of God for the habitation of bees we see the hexagonal shape on which God designed creation upon as shown in figure (2). We also notice a perfect match between the representation of number 19 from a mathematical point of view and the pattern on which God created and designed the hexagonal structure of bee hives.





**Figure (2): Hexagonal design of a bee hive.**

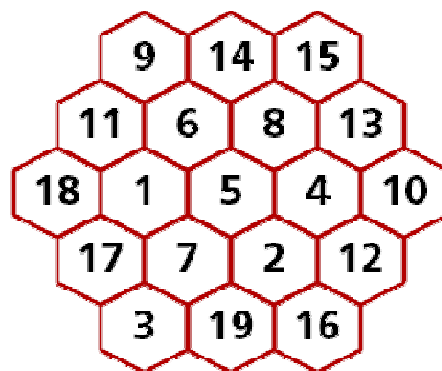
He explained that God teaches us that the best way to build structures is to arrange the basic units comprising it in a hexagonal pattern like the geometrical shape of the number 19.

**“And your Lord taught the honey bee to build its cells in hills, on trees, and in (men’s) habitations”**

*(Sura – 16, Verse – 68, Holy Quran)*

*“Bees have been using the hexagonal structure for the construction of the honeycombs for millions of years. There is a bee fossil is found dating 100 million years. It is a wonder why they have chosen the hexagonal structure rather than octagonal, or pentagonal?”*

*The answer is given by the mathematicians: “hexagonal structure is the most suitable geometric form for maximum use of unit area” If the honeycomb cells were constructed in another form, then there would be areas left out of use; thus less honey would be stored, and less bees would be able to benefit from it.*



***Magic Hexagon – Numbers 1 to 19***

$$\Sigma = 38 = 19 \times 2$$

As long as their depths are the same, a triangle or quadrangle cell would hold the same amount of honey as a hexagonal cell. But, among all these geometric forms, hexagon is the one with the shortest circumference. Whilst they have the same volume, amount of wax required for hexagonal cells is less than that required for a triangular or quadrangular one.

So, the conclusion is: Hexagonal cell requires minimum amount of wax for construction while it stores maximum amount of honey. This result, obtained after many complex geometrical calculations, can surely not have been calculated by bees themselves. These tiny animals use the hexagon form innately, just because they are “taught” and inspired so by their Lord.

The hexagonal design of the cells is practical in many aspects. Cells fit to each other and they share each other’s walls. This, again, ensures maximum storage with minimum wax. Although the walls of the cells are rather thin, they are strong enough to sustain a few times of their own weight.

Besides the side walls, the same principle of maximum saving is considered also while the bottom edges are constructed.

Combs are built as a slice with two lines lying back to back, where the connection point problem occurs. This problem is solved by constructing the bottom surfaces of cells by combining three equilateral quadrangles. When three cells are built on one face of the comb, the bottom surface of one cell on the other face is automatically constructed.

As the bottom surface is composed of equilateral quadrangle wax plaques, the depth increases in these cells, which results in an increase in the volume and thus in the amount of honey to be stored.

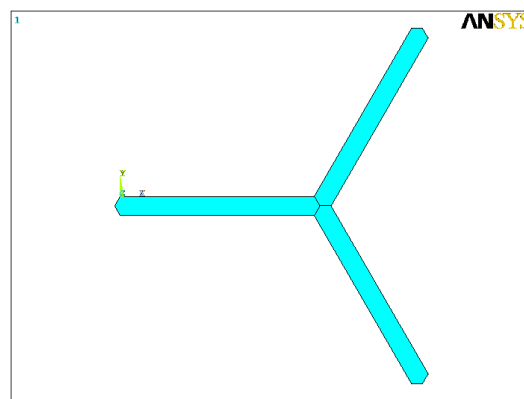
This is a diameter-5 magic hexagon. Each integer from 1 to 19 appears exactly once, and the sum of the numbers along any column or diagonal is the same ( $38 = 19 \times 2$ ). It is easy to prove that 1 and 5 are the only possible magic hexagon diameters, using the numbers from 1 to the hexagon size. The diameter-1 magic hexagon is trivial, and the diameter-5 magic hexagon is essentially unique. There are 12 variations which arise by rotating and reflecting the hexagon under the action of the dihedral group of order 12.”

**(Reference: <http://www.answering-christianity.com/fakir60/bee.htm>)**

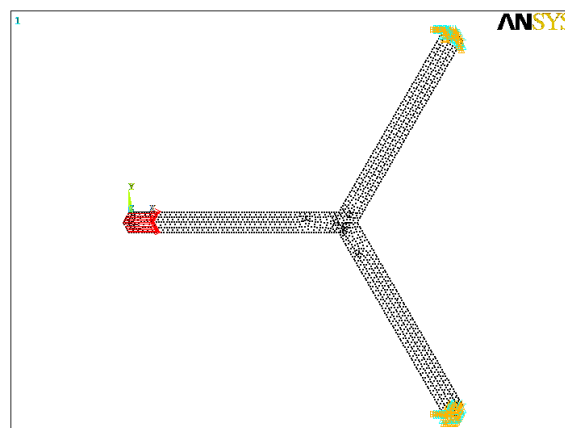
Now if we want to build a house from boards as the ones shown in figure (3) then the design that we learn from the Holy Quran is to build the house by arranging these boards in a hexagonal shape as shown in figure (4).



*Figure (3): Boards comprising a house*

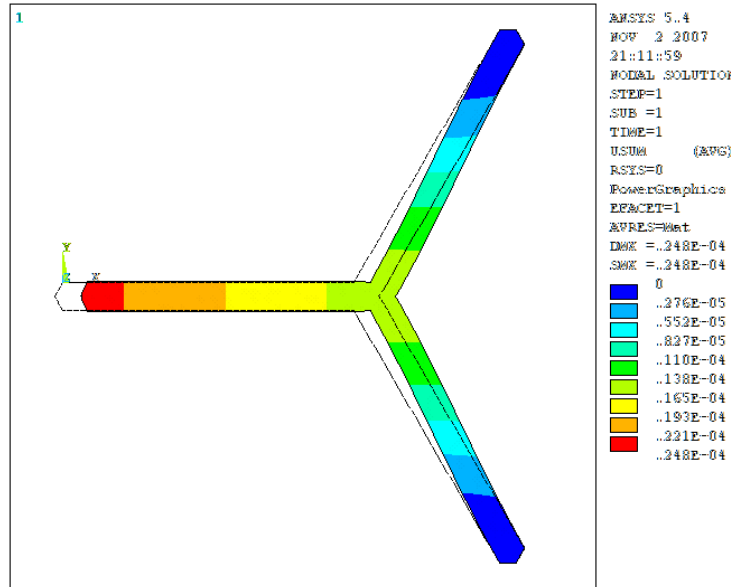


He made a study to investigate the resistance of the design shown in figure (4) to lateral displacements like those generated when an earthquake occurs. He explained that the devastating effect of an earthquake results from lateral displacements on the walls of a structure. The study involved building a model shown in figure (5) where 1000 N force is applied on the horizontal wall to generate a lateral displacement like the one produced in an earthquake.

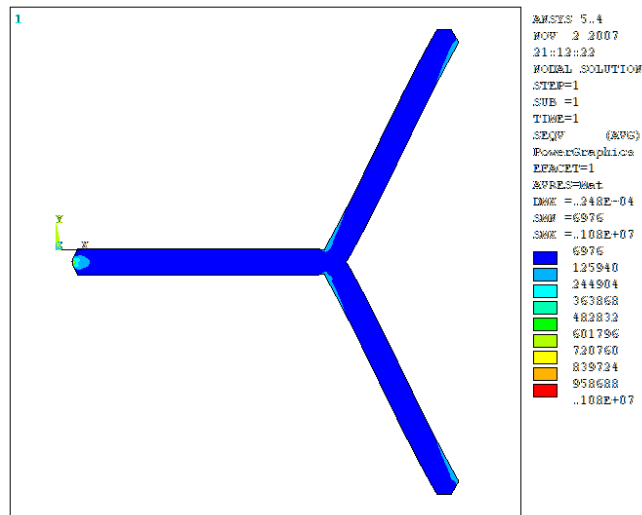


*Figure (5): Placing forces and fixation on the model taken from the number 19*

He mentioned that he concentrated on the results which are the overall displacement and stresses within the model, and the figures (6) and (7) show these results within the model.

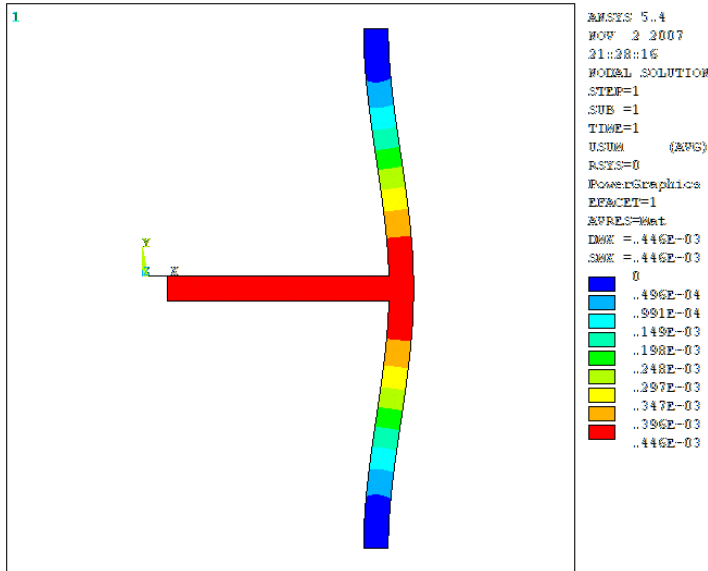


**Figure (6): Overall displacements generated within the model**

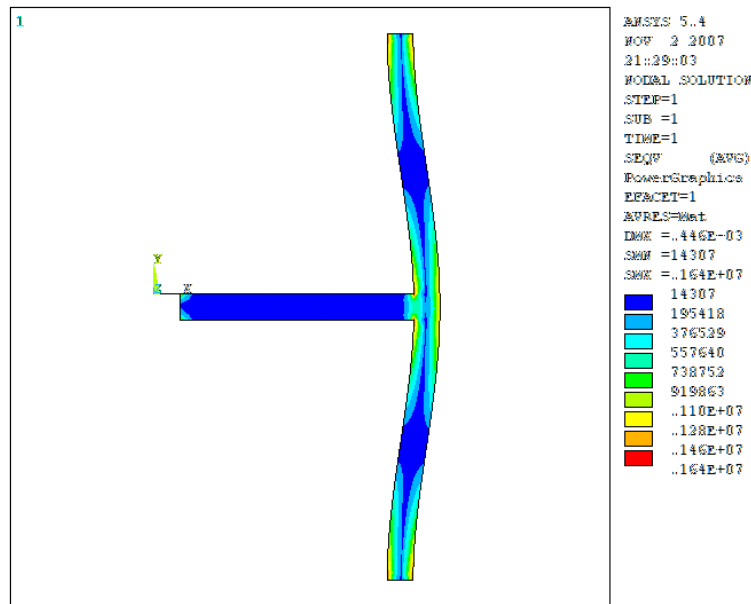


**Figure (7): Overall state of stress within the model.**

If we compare the results shown in figures (6) and (7) with the results obtained from the current design of buildings where T-sections are used to erect rooms in a house shown in figures (8) and (9)



**Figure (8): Overall displacement in a model based on the current design of walls in a building**



**Figure (9): Overall state of stress in a model based on the current design of walls in a building.**

**Table (1) shows a comparison between the results for the current design for buildings and the design based on the number 19.**

	Design based on Number 19	Current Design for Buildings	Percentage increase or decrease
Overall Displacement	$0.24 * 10^{-4} \text{ m}$	$0.446 * 10^{-3} \text{ m}$	94.62% (Decrease)
Overall Stress	$1.08 * 10^6 \text{ Pa}$	$1.64 * 10^6 \text{ Pa}$	34% (Decrease)

**Table (1): Comparison between the overall displacement and stress for two designs**

We clearly find from the above results showed in table (1) that there is a significant reduction in the overall displacement and stress in a design based on the number 19 compared to the current design for buildings. The reduction in displacements means an increased stability for the structure under lateral loading and the reduction in stresses indicates an increased strength in the structure.

*(Reference: [www.quran-miracle.com](http://www.quran-miracle.com))*

### **Conclusion:**

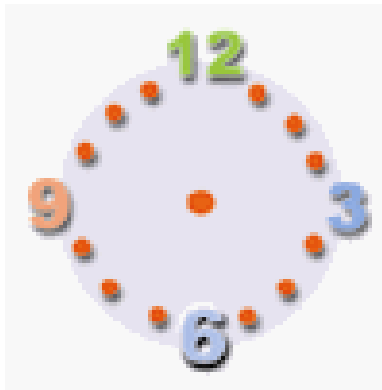
We can conclude that if design structures on Number – 19, they can resist earthquakes more effectively as proven from the results of study. We now also understand now why bee hives remain stable and strong under the effect of large vibrations generated from the bees surrounding the hive.

## Time and 19



We see the relationship between the Time and the Number – 19 in different ways.

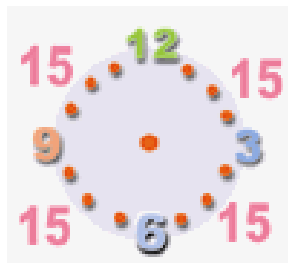
- In first case, if we look at our watch, we would see these numbers:



If we put all these numbers as:

$$12\ 3\ 6\ 9 = 19 \times 651$$

- This circle of time is divided into 4 major parts. Each part represents 15 minutes. From 12, 15 minutes to 3, 15 minutes to 6, 15 minutes to 9, 15 minutes to 12 (12 appear just 1 time)



$$12\ 15\ 3\ 15\ 6\ 15\ 9\ 15 = 19 \times 63963979785$$

- Now from 12, 30 minutes to 6 and from 6, 30 minutes to 12 (12 appear just 1 time)



$$12\ 30\ 6\ 30 = 19 \times 64770$$

- 1 hour = 60 minutes, 1 minute = 60 seconds, 1 day = 24 hours – 3 basics of time & day



$$60\ 60\ 24 = 19 \times 31896$$

- 60 minutes can be divided into 15, 15, 15, and 15 minutes, so replace 60 minutes to those numbers as:

$$15\ 15\ 15\ 15\ 60\ 24 = 19 \times 7974481896$$

- 1 hour = 60 minutes, 1 day = 24 hours. Thus 1 day = 24 x 60 = 1440 minutes. 1440 minutes represent 1 day.

$$1440 + 1440 + 1440 + 1440 + 1440 + 1440 + 1440 = 7\ \text{days (1 week)}$$

Now if we write the numbers representing 7 days of a week as:

$$1440\ 1440\ 1440\ 1440\ 1440\ 1440\ 1440\ 7 = 19 \times 757970533895494812639158653$$





- 1 day = 24 hours = 12 + 12 hours

$$12 + 12 + 12 + 12 + 12 + 12 + 12 + 12 + 12 + 12 + 12 + 12 + 12 + 12 = 7 \text{ days}$$

Now if we write the numbers as:

$$12 \ 12 \ 12 \ 12 \ 12 \ 12 \ 12 \ 12 \ 12 \ 12 \ 12 \ 12 \ 12 \ 12 \ 7 = 19 \times 637958532695374800637958533$$

(Reference: [http://numerical19.tripod.com/time\\_pattern\\_19.htm](http://numerical19.tripod.com/time_pattern_19.htm))

## 12 Months and 19:

There are 12 months in a year. The Number – 12 is the 7<sup>th</sup> Even Number. Adding 12 and 7, we would get:

$$12 \text{ months} \text{ ----- } 1 \text{ year} \text{ ----- } 12 \text{ ----- } 7^{\text{th}} \text{ Even Number}$$

$$12 + 7 = 19$$

## 30 days of a month and 19:

There are months of 30 days in a year. The Number – 30 is the 19<sup>th</sup> Composite Number.

$$30 \text{ days} \text{ ----- } \text{month} \text{ ----- } 30 \text{ ----- } 19^{\text{th}} \text{ Composite Number}$$

$$30 \text{ ..... } 19^{\text{th}} \text{ Composite Number}$$

## Conclusion:

Our time and the Number – 19 are directly linked with each other as illustrated in the above examples and so the Number – 19 is also the secret code of Time.

**"He Who has made everything which He has created most good"**  
**(Holy Quran 32:7)**

## Meton Cycle and 19



The number nineteen is of special significance to the cycles of the moon in their interaction with the solar year. The ancients noted that every nineteen years the full Wolf Moon arose on the first day of the new year, December 23, and it was often eclipsed. In addition to this, the moon also stayed at its northernmost latitude almost constantly at this time, appearing to "stand still" in the north. In fact, each moon repeated itself in a nineteen year cycle and thus became symbolized by Brigit's 19 priestesses. Arienrhod has been associated with this cycle, as has Dôn, Caillech & Brigantia.

The myth description was that Belenos was at the moment of this great northernmost full moon eclipse, visiting the Moon Goddess in her northern temple - or, in an alternate version, the moon god Lugh stays with the Mother in her northern castle as representative of the rite of sovereignty. It is said that at this time our blessed Sun comes among us to dance and play. Brigantia, the northern mother goddess and the lunar Bridget, was the one usually so strongly associated with this cycle that her priestesses became synonymous with it.

The cycle is called, by modern astronomy, the Metonic Cycle, and by the ancients the Lunar Great Year. The megaliths of our people show this same geometry. Nineteen and 30 stone patterns, both indicating the lunar pattern of 19 solar years and  $29\frac{1}{2}$  or 30 days. These are then coordinated with the 8 high days of the solar year by visual sunrise and sunset alignment in the stones.

One of the mysteries of Caer Manon (Stonehenge) is the so-called "heel" stone. Modern archeologists have continually debated its purpose, frequently assuming that it was a winter solstice sunrise marker. This theory, though it has many proponents, is disappointing as, unfortunately, the midwinter sun doesn't rise above the stone. The solstice full moon, however, does. There is another stone placement that has been found slightly to the left of the "heel" stone whose purpose is in this day not known. It may be a solar marker, it may be a lunar marker for the "minor" standstill of the moon approximately  $9\frac{1}{2}$  years, or halfway through the cycle. It is yet to be understood.

This minor standstill does have its own mythic cycle. At the minor standstill which occurs at the summer solstice the full Mead Moon arises, heralding the beginning of a new eclipse season. The bright lord of the sun visits the Lady in her southern temple. At this time the moon is frequently seen to be eclipsed also. This is followed by a time wherein the moon has gained ascendancy - eclipsing the sun as Lugh did eclipse his solar father, Balor, the dark sun. Another aspect of this is the moon's ascendancy or gaining sovereignty by his wedding the Sun Mother in southern

castle. Yes, as the solar year has a bright and a dark half, so does the Lunar Greater Year.

Our moon cycle and our sacred circle have been synthesized into a core of that which our ancestors created the megaliths for. Consider this aspect of the geometry. The megaliths were all constructed with a special set of measurements, now called Megalithic Yards and Megalithic Rods. The Megalithic Yard was 2.72 of our modern measurement of feet. Our current use of multiples of three in measuring our magic circle comes from an approximation of this. But it doesn't stop here. We consider the phases of the moon especially appropriate and herein lies the Megalithic Rod. A Megalithic Rod is 2.5 times the length of the Megalithic Yard, or 6.8 feet - so very close, that we approximate it as 7 modern feet, or the number of days of one of the moon's four phases. Each of the 30 Saracsen stones in the circle of Caer Manon is one Megalithic Yard across, with ½ a Megalithic Rod in between - which makes its circumference 45 Megalithic Rods, a multiple of 9, the other "lunar" number.

A direct relationship between the solar and lunar cycles can be seen again in the 56 so-called "Aubrey Circle" post holes which form the outermost circle inside the embankment around Caer Manon. These represent a more exact reckoning of the lunar great year which is actually not 19 years, precisely, but 18.61 - three cycles of which become 56 years - seen as three cycles consisting of 19, 19 and 18 years. Even so, the difference is so minor that, although eclipses may not be accurately predicted, for the purpose of predicting full moons, the charts that follow will certainly be accurate in my lifetime and in those of my children future grandchildren. It may fail for future generations and I leave it to my successors to provide corrections so that its information may be of use to them.

Each of the 19 solar years of the Lunar Great Years has a goddess patroness whose attributes are often seen throughout the year. Details of an individual year's events can be foreseen and the pattern of potential challenges which may occur understood by a contemplation of the "ruling" goddess and also by being aware of its position in the 9 solar year aspect cycle called the Cycle of the Sun Mother.



## **The 19 Solar Years and Patronesses of the Lunar Greater Year are:**

- 1. Nimuè - the Lady of the Lake who rules the Year of the Sky Father's Spear.**
- 2. Rosemertha - the Cornmother who rules the Year of the Threshing.**
- 3. Dôn - the White Sow who rules the Year of The Sacred Sowing.**
- 4. Etain/Edain - Twin Chained Swans who rules the Year of Fertilization.**
- 5. Elen - Leader of Hosts who rules the Year of the Emerging Goat.**
- 6. Rhiannon - the Queen Mare who rules the Year of the Flying Crane.**
- 7. Arienrhod - the Queen of the Heavens who rules the Year of the Lady.**
- 8. Morrigan - the Queen of the Ravens who rules the Year of the Ram's Head Serpent.**
- 9. Caillech - the Veiled One who rules the Year of the Ancient Oak.**
- 10. Hertha - the Horned Cow who rules the Year of the Golden Bull Reborn.**
- 11. Artio - the She Bear who rules the Year of the Huntress.**
- 12. Bridget - Exalted One of the Perpetual Flame who rules the Year of the Sun.**
- 13. Andraste - the Winged Victory who rules the Year of the Sky.**
- 14. Blodeuedd - the Flower Faced who rules the Year of the Wild Rose.**
- 15. Brigantia - of the Herds who rules the Year of the Harvest Gathering.**
- 16. Vivian - Maiden Queen of the Land of Women who rules the Year of the Rising Moon.**
- 17. Flíodhas - the Doe-eyed who rules the Year of the Stag King of the Forest.**
- 18. D'Anu - Mother of Civilization who rules the Year of Man.**
- 19. Gabba - the Crystalline Faced who rules the Year of the Devouring Earth.**

(Reference: <http://www.answering-christianity.com/fakir60/07.html>)

## Universe and 19



- The Sun, Moon and Earth lineup in the same relative positions once every 19 years. The Metonic cycle used to calculate the date of Easter is 19 years long. Halley's Comet passes through the solar system once every 76 years, which is a multiple of 19.

$$19 \times 4 = 76 \text{ years}$$

- Number – 19 is symbolized as ‘Sun’ in Numerology and Sun has 8 planets.

**Sun has 8 planets**



**Number – 19 is also the 8<sup>th</sup> Prime Number**

### Earth Mass and Volume and 19:

- Earth's mass ( $5.9736 \times 10^{24}$ ) and volume ( $1.083 \times 10^{12}$ ) are both multiples of 19. Earth's volume is in fact a multiple of  $19^2$ .

$$\text{Earth's Mass} = 5.9736 \times 10^{24} - \text{Multiple of 19}$$

$$= 19 \times 3.144 \times (10^{23})$$

$$\text{Earth's Volume} = 1.083 \times 10^{12} - \text{Multiple of } 19^2$$

$$= 19^2 \times 3 \times (10^9)$$

In the issue of 'National Geographic' Magazine of December, 2006, a chart was published on universe, stars, change of planets from nine (9) to eight (8) and also stated:

## "19 Trillion miles to explore in space"

So even the modern scientists and astronomers come to the conclusion that nineteen (19) is playing role in our universe. Then there is a link between 19 and 8, because Number 19 is the 8<sup>th</sup> Prime. So with the Universe with 19 trillion miles to explore, there are 8 planets in our Solar System as per the latest research and findings by NASA scientists.

If we add  $19 + 8 = 27$

$$27 = 3 \times 3 \times 3 \text{ ----- perfect cube of } 3$$

Our Spherical Universe is showing a clear pattern of repeated numbers in all areas of life, time and space.



The following is the extract taken from:

(<http://www.answering-christianity.com/fakir60/plananom.htm>) showing the role of Number – 19 in our planets and their volcanoes

“Our solar system is largely unexplored, with only a small number of probes having been sent out to the major planets and moons. Not all of these probes have functioned as advertised and some have even been "lost" in mysterious circumstances! However, some of them have returned very useful information on the planets like the Viking 1 & 2 Mars spacecraft that have had the honor of being the first to photograph Extra-Terrestrial Structures on our neighboring planet.

From these and other photographs, it now is apparent to several researchers that there seems to be a link that connects every single object in our universe including our Earth, the Sun, and the other planets to a source of energy in a higher dimension. This discovery was the result of decoding a message, an ancient message, left to us by another civilization in the geometrical layout of the structures which they built at Cydonia, Mars!

Below are the planetary anomalies discovered so far that confirm the Cydonia hypothesis. If energy cascades down from a higher dimension (up to 27 have been mathematically proven) as a result of a rotating, spherical, liquid body (a planet), this energy enters our dimension at circa

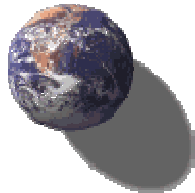
**19.5 degrees N or S latitude** in the form of volcanic upwelling's (as on Earth and Mars) and atmospheric phenomena (Jupiter, Neptune). This has been called Tetrahedral Hyper-dimensional Physics by some researchers. It may be the same type of energy described by others as "free energy" or "zero-point energy"

#### Venus



Alpha & Beta Regio, two active volcanoes on Venus are at **19.5 degrees**

#### Earth



The Hawaiian islands on Earth are located at roughly **19.6 degrees** North latitude. This is also the location of MaunaKea one of the most active volcanoes on Earth

#### Luna (Earth's moon)



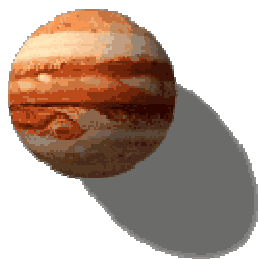
Tsiolkovskii is a unique farside "mare-like" lava extrusion at **19.6 degrees** South.

#### Mars



Olympus Mons, the solar system's largest volcano with a height of 28 kms is 3 times the size of Mount Everest, and just happens to be located at **19.3 degrees** North latitude

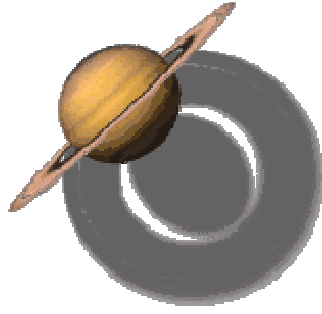
#### Jupiter



The Great Red Spot of Jupiter is located at **~19.5 degrees** South latitude. In January 1996, the spacecraft Galileo successfully launched a probe into Jupiter's atmosphere and found that the atmosphere was different from what had been previously thought. It also found that winds were much stronger and could only be attributed to some heat being generated deep within the planet. This heat is probably caused by

a vorticular upwelling of tetrahedral energy, which in turn causes the Great Red Spot

## Saturn



The spacecraft Voyager took some very interesting time-lapse images of Saturn's North Pole, showing a hexagonal pattern of clouds. This may be the second "signature pattern" for tetrahedral hyper-dimensional energy. At this location, the energy would be "in welling" (entering) from a higher dimension, while "upwelling" at the **19.5 N or S latitude** locations. View Saturn's North Polar Hexagonal Cloud Pattern.

## Neptune



Neptune's Great Dark Spot was found at roughly **19.5 degrees** South latitude by the Hubble Space Telescope. This discovery was predicted months previously by Richard Hoagland just by following the "Cydonia Hypothesis"

These are a few of the anomalies. There are others - for example, the peak latitude of the 11-year sunspot cycle, and the peak latitude of solar temperature emission corresponding to that cyclic sunspot maximum, occurs at roughly **19.5 degrees** North and South! And guess where the massive solar flare erupted on mid-April, 1997 ... ~ 20 degrees S as can be seen from this picture.

Extremely active volcanoes on Io are arrayed on two "rings of fire" each circling the moon at **19.5 degrees** North & South, They are so active that they are literally turning the planet inside out. And more anomalies are out there, just waiting to be discovered when we send spacecraft to photograph Pluto and Charon from close range.

If we can somehow tap into this energy source, we wouldn't need fossil fuels anymore. We would have unlimited energy available for every person on this planet **without pollution**. And we may already have discovered ways of harnessing this energy: the so-called "cold fusion" demonstrated in 1989 by Pons & Fleischmann, and the Patterson Power Cell first demonstrated in January 1996 and presented nationwide on ABC's Good Morning America show of the 11 June 1997, may not be cold fusion at all but may be drawing on hyper-dimensional energy to produce 1300 W from an input of 1.4 W!"

(Reference: <http://www.answering-christianity.com/fakir60/plananom.htm>)



## Music and 19



- 19 is the debut album from English soul and jazz singer Adele.
- 19 is the fourth studio album from Russian pop singer Alsou.
- 19 is Evan Yo's first album, because Yo was nineteen years old when the album was released.
- "**19**" is a 1985 song by Paul Hardcastle, including sampled sound bites taken from a documentary about the Vietnam War in which **19** is claimed to have been the average age of United States soldiers killed in the conflict (an assertion which is widely disputed).<sup>[1]</sup> The song was parodied by British satirist Rory Bremner as N-n-nineteen, Not Out - the title referring to the English cricket team's risible performance against the West Indies in the previous year.
- With a similar name and anti-Vietnam War theme, "**I Was Only Nineteen**" by the Australian group Redgum reached number one on the Australian charts in 1983. In 2005 a hip hop version of the song was produced by The Herd.
- Other songs titled 19:
  - "**Nineteen**" by Bad4good
  - "**Nineteen**" by Buck-O-Nine
  - "**Nineteen**" by Phil Lynott
  - "**Nineteen**" by the Old 97's
  - "**Nineteen**" by Tegan and Sara
- Nineteen has been used as an alternative to twelve for a division of the octave into equal parts. This idea goes back to Salinas in the sixteenth century, and is interesting in part because it gives a system of mean tone tuning, being close to 1/3 comma mean tone.
- Some organs use the 19th harmonic to approximate a minor third.
- The composer Béla Bartók finished his **Opus 19 in 1919**, when he was 38 (19 x 2) years old; the title in his native Hungarian (A csodálatos mandarin) has **19 letters**.
- Steely Dan had a hit song called "**Hey Nineteen.**"
- **19th Nervous Breakdown** was a hit for the Rolling Stones in 1966. It reached No 2 in both the UK and USA charts.

(Reference: [http://en.wikipedia.org/wiki/Number\\_19](http://en.wikipedia.org/wiki/Number_19))

## Games and 19



- In the game of Go, which originated in China more than four thousand years ago, two players alternate in placing black and white stones on a large 19 x 19 line ruled board, with the aim of surrounding territory. The board of the ancient game of 'GO' has 19 vertical and 19 horizontal lines.



19 x 19 Go Board

- 19 is the command in Age of Empires for the laughing emote. This was an easier way to laugh before "LOL" existed.
- Though the maximum score for a hand of cribbage is 29, there is no combination of cards that adds up to 19 points. Many cribbage players, therefore, jokingly refer to a zero-point hand as "19 points."
- In Ecuadorian card game "40", when counting the amount of cards gathered in a hand, the limit is 19, after which the count starts at 6 and represents the points achieved during that hand.
- Checkmate in a King + Opposite Colored Bishops versus King end game requires, at most, 19.
- A hoax chess machine nicknamed "the Turk" once sent Napoleon Bonaparte into a fury by beating him in 19 moves.

(Reference: [http://en.wikipedia.org/wiki/Number\\_19](http://en.wikipedia.org/wiki/Number_19))

## Sports and 19



- In golf the "19th hole" is the clubhouse bar. In miniature golf it is an extra hole on which the winner earns an instant prize.
- 19 is a number retired by several teams in North American sports. (**Except as noted, all players are in the Hall of Fame of their respective sport.**)
  - ✓ **In the NFL:**
    - Lance Alworth, by the San Diego Chargers.
    - Johnny Unitas, by the Baltimore Colts. The team has honored this retirement in its current home of Indianapolis. He used to wear jersey number – 19.
  - ✓ **In Major League Baseball:**
    - Bob Feller, by the Cleveland Indians.
    - Tony Gwynn, by the San Diego Padres.
    - Robin Yount, by the Milwaukee Brewers.
  - ✓ **In the NBA:**
    - Willis Reed, by the New York Knicks.
  - ✓ **In the NHL:**
    - Bill Masterton, by the Minnesota North Stars. The team has honored this retirement in its current home of Dallas. Masterton is not in the Hockey Hall of Fame; his number was retired after he died from an on-ice injury in 1968. He is the only NHL player to have died as a direct result of an injury suffered during an NHL game.
    - Larry Robinson, by the Montreal Canadians.
    - Joe Sakic, by the Colorado Avalanche. Sakic is not yet eligible for the Hall of Fame, as he retired in 2009.
    - Bryan Trottier, by the New York Islanders.
    - Steve Yzerman, by the Detroit Red Wings. Some Red Wings fans collectively refer to themselves as "the 19" in his honor.
  - ✓ **In NASCAR**
    - NASCAR Sprint Cup Series driver Elliott Sadler drives the **#19** Best Buy Ford Fusion for Richard Petty Motorsports.

(Reference: [http://en.wikipedia.org/wiki/Number\\_19](http://en.wikipedia.org/wiki/Number_19))

## Literature and 19



- **Stephen King's** seven book epic *The Dark Tower saga* employs the **number 19** in books *The Dark Tower: The Gunslinger*, *The Dark Tower V: Wolves of the Calla*, and *The Dark Tower VI: Song of Susannah* as a mysterious and important number. They refer to the "ka-tet of 19", many names add up to 19, 19 seems to permeate every aspect of Roland and his traveler's lives. In addition, the number ends up being a powerful key.
- In **Jodi Picoult's** bestseller book *Nineteen Minutes*, the number 19 is referenced multiple times. It is most commonly referenced when referring to the main subject of the book, the school shooting rampage that took place over a span of **19 minutes**.

(Reference: [http://en.wikipedia.org/wiki/Number\\_19](http://en.wikipedia.org/wiki/Number_19))



(Reference: <http://en.wikipedia.org/wiki/Hamlet>)

- The Hamlet from Shakespeare is also composed out of only **nineteen consonants**.
- In his August 1941 Afterward to Thomas Wolfe's book *The Hills Beyond*, NY, Wolfe's editor, Edward C. Aswell, remarks that Thomas Wolfe's second book, never published, was to have been titled K19. When Wolfe died, Aswell watched the train carrying his coffin goes by Train **K19!**
- Hangeul (the Korean alphabet) has 19 consonants.

## Age and 19



- 19 is the minimum age that is legal to buy tobacco products in Alabama, Alaska, New Jersey, Utah, and Nassau, Suffolk, and Onondaga counties in New York.
- 19 is the minimum age at which one can drink and buy alcohol in Canada except for the provinces of Alberta, Manitoba, and Quebec where the drinking and purchase age of alcohol is 18.
- 19 is the minimum age to marry in the state of Nebraska.
- 19 is the command in *Age of Empires* for the laughing emote. This was an easier way to laugh before "LOL" existed.
- The average age of U.S. soldiers serving during the Vietnam War was 19.

## Holidays, Observances and 19



### 19<sup>th</sup> January:

- Birthday of Edgar Allan Poe (commemorated by the Poe Toaster at his grave in Baltimore)
- Christian Feast Day
  - Henry of Uppsala
  - Maris, Martha, Abachum and Audifax
  - Mark of Ephesus
  - Pontianus.
  - Wulfstan, Bishop of Worcester
  - January 19 (Eastern Orthodox liturgics)
- Confederate Heroes Day (Texas)
- Feast of Sultán (Sovereignty), first day of the 17<sup>th</sup> month of the Bahá'í calendar (Bahá'í Faith)
- Founders Day (Kappa Alpha Order Convivium)
- Theophany / Epiphany (Eastern and Oriental Orthodoxy, who follow the Julian Calendar)

### 19<sup>th</sup> February:

- Birthday of Shivaji or Shivaji Jayanti (Maharashtra)
- Chaoflux (Discordianism)
- Christian Feast Day:
  - Barbatus of Benevento
  - Conrad of Piacenza
  - February 19 (Eastern Orthodox liturgics)
- Flag Day, the birthday of the President Saparmurat Niyazov, established in 1997 (Turkmenistan)
- Narconon Day (Church of Scientology)
- The hanging of Bulgaria's Apostle of Freedom Vassil Levski (Bulgaria)

## 19<sup>th</sup> March:

- Christian Feast Day:
  - Joseph (Western Christianity)
  - March 19 (Eastern Orthodox liturgics)
- Earliest day on which Maundy Thursday can fall, while April 22 is the latest; celebrated on Thursday before Easter. (Christianity)
- Mojoday (Discordianism)
- Saint Joseph's Day (Roman Catholicism and Church of England) related observances:
  - Father's Day (Spain, Portugal, Belgium, Italy, Honduras, and Bolivia)
  - Las Fallas, celebrated on the week leading to March 19. (Valencia)
  - "Return of the Swallow", annual observance of the swallows' return to Mission San Juan Capistrano in California.
- The Kashubians' Unity Day.
- The first day of Quinquatria, held in honor of Minerva. (Roman Empire)

## 19<sup>th</sup> April:

- April 19 is the 109<sup>th</sup> Day of the year and 110<sup>th</sup> Day (110 = 19 + 91) in leap year.
- Beginning of the Independence Movement (Venezuela)
- Bicycle Day
- Christian Feast Day:
  - Ælfheah of Canterbury
  - Emma of Lesum
  - Expeditus
  - George of Antioch
  - Pope Leo IX
  - April 19 (Eastern Orthodox liturgics)
- Dutch-American Friendship Day (United States)
- Earliest day on which First Day of Summer or Sumardagurinn fyrsti can fall, while April 25 is the latest; celebrated on the first Thursday after April 18. (Iceland)
- King Mswati III's birthday (Swaziland)
- Landing of the 33 (Uruguay)
- Patriots' Day (Traditional) (Massachusetts, Maine, and Wisconsin, USA)
- Primrose Day (United Kingdom)
- The last day of the Cerealia (Roman Empire)

## 19<sup>th</sup> May:

- Christian Feast Day
  - Calocerus (Eastern Orthodox Church)
  - Dunstan
  - Ivo of Kermartin
  - Joaquina Vedruna de Mas
  - Maria Bernarda Bütler
  - Peter Celestine
  - Pudentiana (Roman Catholic Church)
  - May 19 (Eastern Orthodox liturgics)
- Commemoration of Atatürk, Youth and Sports Day (Turkey, Northern Cyprus)
- Greek Genocide Remembrance Day (Greece)
- Hồ Chí Minh's Birthday (Vietnam)
- World Hepatitis Day (International)

## 19<sup>th</sup> June:

- Ásatrú Alliance Founding Day (Germanic Neopaganism)
- Birthday of José Gervasio Artigas (Uruguay)
- Christian Feast Day
  - Gervasius and Protasius (Roman Catholic Church)
  - Juliana Falconieri
  - Romuald
  - Zosimus
  - June 19 (Eastern Orthodox liturgics)
- Feast of Forest (Palawan)
- Juneteenth (United States, especially African Americans)
- Labour Day (Trinidad and Tobago)
- Laguna Day (Laguna)
- Surigao del Sur Day (Surigao del Sur)

## 19<sup>th</sup> July:

- Burmese Martyrs' Day (Burma)
- Christian Feast Day:
  - Arsenius (Roman Catholic Church)
  - Bernold, Bishop of Utrecht
  - Justa and Rufina
  - Kirdjun
  - Macrina the Younger, Sister of St. Basil the Great
  - Symmachus



- July 19 (Eastern Orthodox liturgics)
- Sandinista Day or Liberation Day (Nicaragua)

## **19<sup>th</sup> August:**

- Christian Feast Day:
  - Jean-Eudes de Mézeray
  - Louis of Toulouse
  - Magnus of Anagni
  - Magnus of Avignon
  - Sebaldus
  - August 19 (Eastern Orthodox liturgics)
- Independence Day, commemorates the Treaty of Rawalpindi in 1919, granting independence from Britain. (Afghanistan)
- Manuel Luis Quezón Day (Quezon City)
- National Aviation Day (United States)
- Saviour's Transfiguration, popularly known as the "Apples Feast". (Russian Orthodox Church and Georgian Orthodox Church), and its related observances:
  - Buhe (Ethiopian Orthodox Church)
- Vinalia Rustica (Roman Empire)
- World Humanitarian Day (International)

## **19<sup>th</sup> September:**

- Armed Forces Day (Chile)
- Christian Feast Day:
  - Goeric of Metz
  - Januarius (Western Christianity)
  - Theodore of Tarsus (Church of England)
  - Trophimus, Sabbatius, and Dorymedon
  - September 19 (Eastern Orthodox liturgics)
- Independence Day, celebrates the independence of Saint Kitts and Nevis from the United Kingdom in 1983.
- International Talk Like a Pirate Day (popular)

## 19<sup>th</sup> October:

- Armilustrium (Roman Empire)
- Christian Feast Day:
  - Aaron (Coptic Church)
  - Frideswide
  - Isaac Jogues, Jean de Brébeuf, and Companions
  - October 19 (Eastern Orthodox liturgics)
- Constitution Day, in honor of the country's independence (self-governing in free association with New Zealand) in 1974. (Niue)
- Mother Teresa Day (Albania)

## 19<sup>th</sup> November:

- Christian Feast Day:
  - Obadiah (Eastern Catholic Church)
  - Raphael Kalinowski
  - Severinus, Exuperius, and Felician
- Discovery of Puerto Rico (Puerto Rico)
- Flag Day (Brazil)
- International Men's Day (Australia, Canada, Ghana, Hungary, India, Ireland, Jamaica, Malta, Singapore, South Africa, Trinidad and Tobago, United Kingdom, United States)
- World Toilet Day (World Toilet Organization)

## 19<sup>th</sup> December:

- Christian Feast Day
  - O Radix
  - Pope Anastasius I
- Liberation day (Goa)
- Opalia (Roman Empire)

(References: <http://en.wikipedia.org/wiki>)

## Websites and 19



The following websites contain the Number – 19 in their domain names:

- <http://www.19entertainment.com/>
- <http://www.19pakasia.com/>
- <http://www.article19.org/>
- <http://www3.yeson19.com/>
- <http://www.noonproposition19.com/>
- <http://www.day19.com/>
- <http://www.192021.org/>
- <http://numerical19.tripod.com/>
- <http://www.ink19.com/>

## World and 19



**An *idiot* is someone with an intelligence quotient (I.Q.) less than 19.**

- Amendment 19 to the United States Constitution gave women the right to vote.
- A Street in Rome named St. John's Lane is only 19 inches wide.
- Renault 19, a car that was produced by French automobile manufacturer Renault.



- 19 European nations who endorsed the first international ban on human cloning.
- Product 19 is a multi-vitamin and mineral cereal of toasted corn, oats, wheat and rice.
- Pont du Gard aqueduct in southern France was built in 19 B.C.
- A gene on Chromosome 19 has been linked to Alzheimer's disease.
- The largest prime on the Ishango Bone. It is currently located on the 19th floor of the Royal Institute for Natural Sciences of Belgium, in Brussels.
- Paul Erdős is said to have lived on coffee, doing mathematics 19 hours a day.
- Scores of people once died from the Anthrax bacterium following an accident at "Compound 19," a Soviet military facility in the city of Sverdlovsk, now called Yekaterinburg.
- Flight 19 disappeared in the Bermuda Triangle.
- The smallest number of neutrons is 19 for which there is no stable isotope.
- The main building of the North Dakota State Capitol is a 19-storey Art Deco skyscraper. It is the tallest building in North Dakota in terms of stories.
- Messier object M19, a magnitude 8.5 globular cluster in the constellation Ophiuchus.
- The Vice-President of the United States rates a 19-gun salute.
- 19 is the term used to describe a worthless hand in the game of cribbage.
- Freud was 19 years older than Jung.
- "The Sun" is numbered with 19 in Tarot cards.

- 19 people had been hanged by the time the Salem witch hysteria died down in 1692.
- The Statue of Liberty's torch shines through leaded glass, illuminated by 19 lamps.



**Statue of Liberty – torch shines and illuminated by 19 lamps**

- The New General Catalogue object NGC 19, a barred spiral galaxy in the constellation Andromeda.
- I-19 is the designation for a US interstate highway in Arizona



- The speed limit (in miles per hour) on the private roads of the Cambourne development near Cambridge, England.
- Professor Barabasi and his team has found that the World Wide Web on average has 19 clicks of separation between web-pages.



- **Article 19** of the Universal Declaration of Human Rights: "Everyone has the right to the freedom of opinion and expression; this right includes freedom to hold opinions without interference and to seek, receive and impart information and ideas through any media and regardless of frontiers."



- The second (and last) trip of the *USS Absaroka* across the Atlantic to European waters ended in New York in February **1919**. On December 24, 1941, the Japanese submarine I-19 fired two torpedoes at that same ship, which was carrying a cargo of lumber, two miles off Pt. Fermin (San Pedro, California). The ship didn't sink but one sailor was killed by falling lumber.



- The prime rate published in the Wall Street Journal was 19.00 for over a month in 1980 and 1981. This remains the highest prime-numbered prime rate ever published.

- The Nineteenth Air Force is a Numbered Air Force of the United States Air Force headquartered at Randolph Air Force Base and belonging to the Air Education and Training Command. It is responsible for managing all flying training in AETC.



- USA Government had alleged 19 terrorists for their involvement in 9 -11 USA - World Trade Center terrorism.
- There is one of the expeditions known as Expedition – 19 of NASA to the International Space Station.  
([http://www.nasa.gov/mission\\_pages/station/expeditions/expedition19/index.html](http://www.nasa.gov/mission_pages/station/expeditions/expedition19/index.html))
- The name of the Chanel perfume - N°19.



- Galaxy 19 – A TV Channel (Reference: <http://www.lyngsat.com/galaxy19.html>)
- The Saros number of the solar eclipse series which began on 2333 BC June 15 and ended on 1035 BC August 1. The duration of Saros series 19 was 1298.1 years, and it contained 73 solar eclipses.
- The Saros number of the lunar eclipse series which began on 2031 BC March 24 and ended on 731 BC May 11. The duration of Saros series 19 was 1298.1 years, and it contained 73 lunar eclipses.
- The *Nineteen Propositions* were demands put to Charles I by Parliament in 1642 intended to limit the power of the Crown. The king's rejection of them led to the English Civil War and his execution.
- To talk '*nineteen to the dozen*' is to talk 'the hind legs off a donkey' or to talk 'a blue streak'.

- Part of the name of a breakfast cereal: Product 19.
- The Soviet submarine K-19 was the first Soviet nuclear ballistic submarine.
- There is a world project of motto: 19 cities in the world with 20 million people in the 21<sup>st</sup> century. (Reference: [www.192021.org](http://www.192021.org))
- October 31<sup>st</sup> is 304<sup>th</sup> day in the normal year of 365 days and  $304 = 19 \times 16$ . Some countries also celebrate Halloween Day on October 31<sup>st</sup> every year.



- 19 years is very close to 235 lunations.



- With a similar name and anti-Vietnam War theme, "I Was Only Nineteen" by the Australian group Redgum reached number one on the Australian charts in 1983. In 2005 a hip hop version of the song was produced by The Herd.
- Nineteen has been used as an alternative to twelve for a division of the octave into equal parts. This idea goes back to Salinas in the sixteenth century, and is interesting in part because it gives a system of mean tone tuning, being close to 1/3 comma mean tone.
- Some organs use the 19th harmonic to approximate a minor third.





## Nineteen - 19 is also:

- In golf the "19th hole" is the clubhouse bar. In miniature golf it is an extra hole on which the winner earns an instant prize.
- The number of Colorado Avalanche center and Captain Joe Sakic.
- It is not possible to earn a score of 19 in a single hand of cribbage.



- June 19th is the birthday of Garfield, the comic strip created by Jim Davis.
- June nineteenth refers to June 19, 1865, the final surrender of the last forces of the Confederate States of America and the formal end of slavery anywhere in the USA.
- The number of brothers Nick and Steve Thiede.
- 19 is The TCP/IP port used for chargen.
- Nineteen has been used as an alternative to twelve for a division of the octave into equal parts. This idea goes back to Salinas in the sixteenth century, and is interesting in part because it gives a system of mean-tone tuning, being close to 1/3 comma mean-tone.



- The statues of Abraham Lincoln and Thomas Jefferson in their respective memorials are 19 feet in height.
- The nineteenth President of the United States was Rutherford B. Hayes.
- The nineteenth state to enter the Union of the United States was Indiana
- Afghanistan gained independence from the United Kingdom on 19<sup>th</sup> August, 1919. August is the 8<sup>th</sup> Month and Number – 19 is the 8<sup>th</sup> Prime Number in mathematics.
- By 2010, the 19<sup>th</sup> tallest high rise building is the Almas Tower in Dubai with height of 363m or 1191ft having 68 floors and completed in 2009.
- The 19<sup>th</sup> largest country in the world is Mangolia with an area of 1,564,100 square kilometers according to the current world statistics in 2010.
- The Democratic Republic of Congo ranks 19<sup>th</sup> country with respect to Population in the world, with a population of 67,827,000 in 2010.
- The 19<sup>th</sup> Marriage Anniversary is known as Bronze Anniversary in Modern USA and known as ‘Aquamarine’ in traditional USA.
- Each individual batch of Maker's Mark Whisky is less than 19 barrels.
- Eugenie Blanchard, a nun who was considered the world's oldest person, died in the French Caribbean island of St. Barts on Thursday, 4<sup>th</sup> November, 2010. She was born on 20<sup>th</sup> July, 1896. Her death leaves Eunice G. Sanborn of Jacksonville, Texas, as the world's oldest person, according to two organizations that monitor that status. She was 114 years old when she died.

**114 years = 19 x 6**

(Reference: [http://en.wikipedia.org/wiki/19\\_\(number\)](http://en.wikipedia.org/wiki/19_(number)))

**“You will not find any flaw in the creation of the All-Merciful. Look again-do you see any gaps? Then look again and again. Your sight will return to you dazzled and exhausted!”**

*(Surat al-Mulk, 3-4)*

## AUTHOR'S CERTIFICATIONS AND 19



1. **High School Certificate (Crescent Model School, Lahore)**
2. **FSc. - Pre Engineering (Government College, Lahore)**
3. **BSc. Civil Engineering (UET – Lahore, Pakistan)**
4. **DCS (PGD in Computer Science – NCCS, Pakistan)**
5. **Web Developer (Nikon, Pakistan)**
6. **MCP (Microsoft Certified Professional, USA)**
7. **MCSE +(Microsoft Certified Systems Engineer, USA)**
8. **MCSD (Microsoft Certified Systems Designer, USA)**
9. **MCDBA (Microsoft Certified Data Base Administrator, USA)**
10. **A+ (USA)**
11. **Network + (USA)**
12. **Internet + (USA)**
13. **CCNA (Cisco Certified Network Analyst, USA)**
14. **Certificate in Auditing (ISO 9000)**
15. **Six Sigma Black Belt (Singapore)**
16. **Lead Auditor – ISO – 9000 - IRQA (UK)**
17. **SQC (Statistical Quality Control, AOTS, Japan)**
18. **Certificate from American Society for Quality, ASQ, USA**
19. **5S (Japan)**

### *19 Certifications*

## AUTHOR'S DATE OF BIRTH AND 19



**Author's Date of Birth ----- 31<sup>st</sup> October, 1968**

**31<sup>st</sup> October ----- 304<sup>th</sup> Day of the Normal Year of 365 Days**

**304..... 19 x 16**

**31<sup>st</sup> October, 1968..... 31 – 10 – 68**

**31 – 10 – 68..... Day – Month -- Year**

**31 10 68 = 19 x 16372**

**311068.....3 + 1 + 1 + 0 + 6 + 8 = 19**

**16372..... 1 + 6 + 3 + 7 + 2 = 19**

**16372.....19**

**311068 = 19 x 16372**

$$311068 = 19 \times 19$$

Now if we multiply the two numbers – 311068 and 16372 and then divide by 19, we see:

$$311068 \times 16372 = 5092805296$$

$$5092805296 = 19 \times 268042384$$

$$268042384 \dots\dots\dots 26 + 80 + 42 + 38 + 4 = 190$$

$$190 = 19 \times 10$$

**Now:**

**31<sup>st</sup> October ----- 304<sup>th</sup> Day of the Year**

**and**

**31 – 10 – 68..... Day – Month -- Year**

If we place 304 before 31 10 68, we would see:

$$304 \ 31 \ 10 \ 68 \text{ ----- } 19 \times 16016372$$

$$16016372 \dots\dots\dots 16 + 01 + 63 + 72 = 152$$

$$152 = 19 \times 8$$

*19 is the 8<sup>th</sup> Prime Number and 31<sup>st</sup> October is the ‘Scorpio’ month and ‘Scorpio’ is the 8<sup>th</sup> Astrological month.*

*31<sup>st</sup> October --- Scorpio ---- 8<sup>th</sup> Astrological Month*

Now if we place 304 after 31 10 68, we would see:

$$31\ 10\ 68\ 304 \text{ ----- } 19 \times 16372016$$

If we multiply the numbers – 304311068 and 311068304, we see:

$$304311068 \times 311068304 = 19 \times 19 \times 16016372 \times 16372016$$

### **Year of Birth – 1968**

The Year of Birth is 1968.....19 and 68

19.....The Perfect Signature of God on His Universe

68.....All Perfect Numbers in Mathematics end either with Number – 6 or 8.

$$6 + 8 = 14$$

$$14 \times 14 = 196.....19 \text{ and } 6$$

$$19 \times 6 = 114 \text{ Chapters of the Holy Quran}$$

$$19/6 = \text{Perfect Pi} = 3.16666.....$$

***“We choose our own Servants”***

*(The Holy Quran)*

## Features of the Book and 19



- **76 Topics = 19 x 4**
- **285 Pages = 19 x 15**
- **63631 Words = 19 x 3349**

$$63631 \dots \dots \dots 6 + 3 + 6 + 3 + 1 = 19$$

- **Book completed on 12<sup>th</sup> October, 2010**

$$2010 - 10 - 12$$

$$2010 \ 10 \ 12 = 19 \times 1057948$$

- **Price = \$ 19 = 19 x 1**

## References and 19



- [http://en.wikipedia.org/wiki/Number\\_19](http://en.wikipedia.org/wiki/Number_19)
- <http://www.qul.org.au/the-holy-quran/mathematical-miracles-in-lexical-concordance>
- <http://www.virtuescience.com/19.html>
- <http://submission.org/miracle/why19.html>
- <http://19.org/>
- <http://primes.utm.edu/curios/page.php/19.html>
- [http://en.wikipedia.org/wiki/Bah%C3%A1%27%C3%AD\\_calendar](http://en.wikipedia.org/wiki/Bah%C3%A1%27%C3%AD_calendar)
- [http://www.miraclesofthequran.com/mathematical\\_03.html](http://www.miraclesofthequran.com/mathematical_03.html)
- <http://www.usn2161.net/19miracle.html>
- <http://www.quranmiracles.com/19/>
- <http://www.quranmiracles.org/>
- <http://numerical19.tripod.com/>
- [http://www.harunyahya.com/miracles\\_of\\_the\\_quran\\_p4\\_01.php](http://www.harunyahya.com/miracles_of_the_quran_p4_01.php)
- <http://www.wattpad.com/70603-quran-miracles-mathematical-miracles-in-lexical>
- <http://www.islam-watch.org/Amarkhan/Miracles-of-Quran-Exposed.htm>
- <http://www.desimuslimchat.com/Islam/documents/19Quran.htm>
- [www.answering-islam.org/Religions/Numerics/](http://www.answering-islam.org/Religions/Numerics/)
- <http://muslimmedianetwork.com/mmn/?p=1328>
- <http://www.quran-miracle.info/>
- <http://www.plichta.de>
- [http://numerical19.tripod.com/114\\_surahs\\_verses.htm](http://numerical19.tripod.com/114_surahs_verses.htm)
- <http://astronlogia.com/2009/01/25/number-19-the-prince-of-heaven/>
- <http://en.wikipedia.org/wiki/Numbers>
- <http://en.wikipedia.org/wiki/Sphere>
- <http://en.wikipedia.org/wiki/Circle>
- <http://en.wikipedia.org/wiki/Pi>
- <http://mrob.com/pub/math/numbers-4.html>
- Studies in Jewish Mysticism, pp. 88-89
- Ramban 1971, Vol.1, p. 10
- <http://www.islamcan.com>



# Highlights of 19



- **19 x 19 is the Super cycle in Bahai's Calendar.**
- **19 lamps shine in the torch of the Statue of Liberty, USA.**
- **19 is the common denominator of the Holy Quran.**
- **The Sun, Moon and Earth lineup in the same relative positions once every 19 years.**
- **19 is the smallest prime mentioned 6 times in the Holy Bible.**
- **There are 19 chapters of the book of the Wisdom of the Ancient Testament.**
- **The Astral body is said to be composed of 19 elements.**
- **19 is the 'God's Secret Formula' applying in Chemistry, Physics, Mathematics and everywhere in the Universe.**
- **Perfect  $\pi$  is equal to 19 divided by 6.**
- **19 is the |1 - 9|th prime number.**
- **The total number of chapters in the Holy Quran is 19 multiplied by 6, i.e.  $19 \times 6 = 114$ .**
- **The numerical value of Allah's name, 'Wahid' is 19.**
- **Number - 19 is symbolized as 'Sun' in Numerology.**
- **Halley's Comet passes through the solar system once every 76 years, which is a multiple of 19, i.e.  $19 \times 4 = 76$ .**
- **Earth's mass and volume are both multiples of 19.**
- **The half-life of oxygen-19 is only 19 seconds.**
- **There are 19 different shapes of Arabic alphabets in Arabic language.**
- **19 is the God's secret Formula according to Dr. Richard Plichta.**
- **19 is the signature of God on the Universe, life, time and space.**
- **19 is the Secret Code of One and Only Almighty God.**