

# Harnessing Cosmic Energy

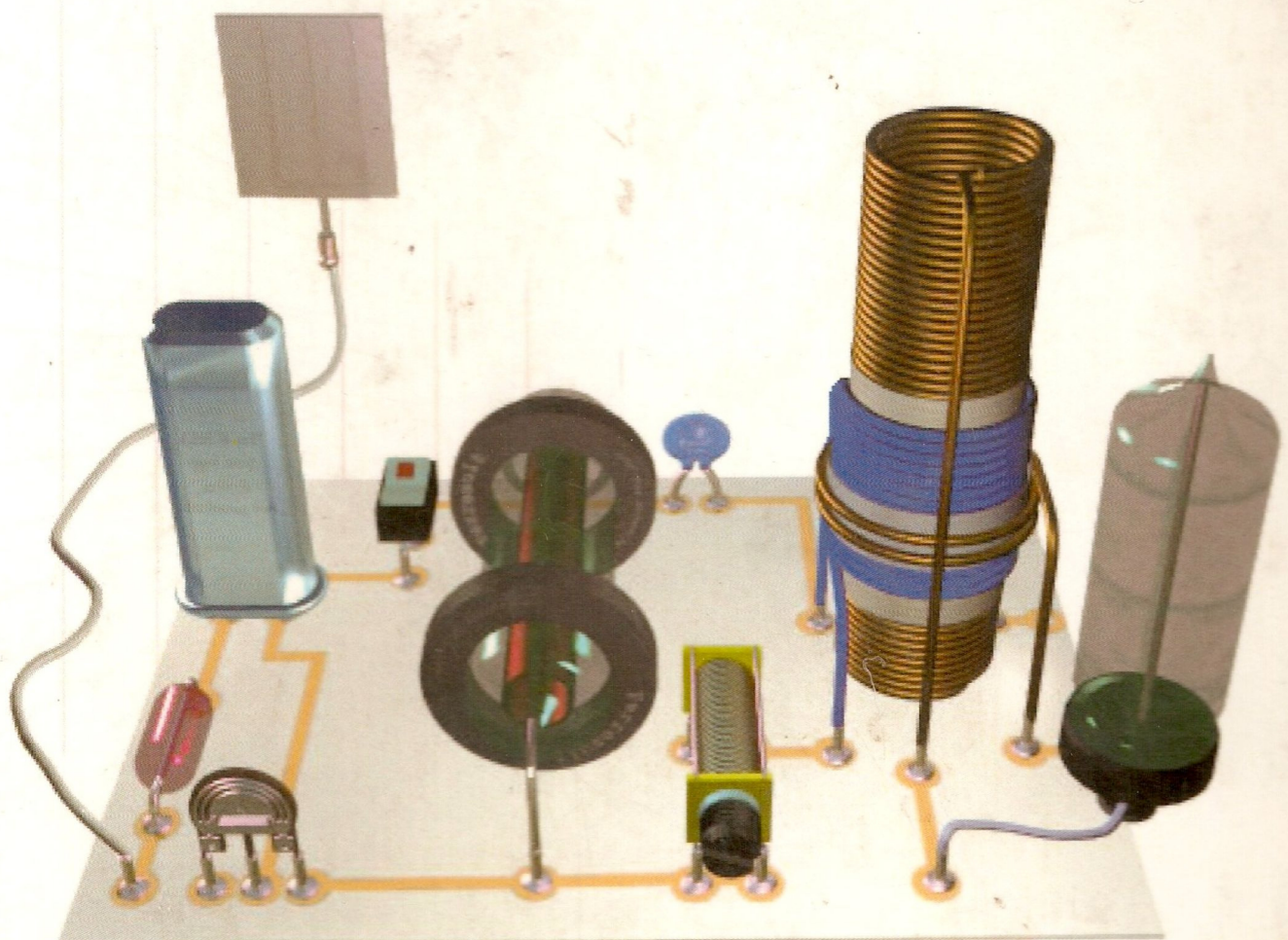



# Dedication

Dr. Thomas Henry Moray, of Salt Lake City, Utah, was probably the first to use radiant energy as a source of power. His tireless effort, to gain recognition for this work, has been an inspiration to me.

The original concepts presented by the late Dr. Thomas Henry Moray, of Salt Lake City, from the year 1909 to 1974, have paved a road to our energy independence. He made history by drawing the attention of the scientific community to certain discoveries of far-reaching importance. His research involved the direct application of radiant energy, to the ultimate electric particles of the atoms and molecules of the universe. Dr. Moray's discoveries, when demonstrated, convinced large numbers of scientific men who had witnessed them in action. However, there were a few scientists in high places who prevented the commercial success of this technology.

If these eminent men, the supposed leaders of the scientific community, had the privilege of studying under Dr. Moray, they would have understood his discoveries and applauded them. But in their ignorance of radiant energy, they refused to believe or even listen politely to the facts that he often demonstrated.

One of his prototypes measured about 42 x 26 x 22 inches and weighed no more than sixty pounds. It generated around four kilowatts of electrical power and was demonstrated in front of too many witnesses to count. Unfortunately, these few people, knowing nothing of the truth, have done incalculable damage to Moray's discoveries over the years.

In its' widest form, radiant energy can be said to be the "Holy Grail of Free Energy". Those who wish to study this exciting subject will do well to give serious attention to Dr. Moray's original discoveries.

It should be as easy to accept the fact that a device can be built to collect and convert ionized particles as it is to accept a radio that receives and converts broadcast waves. The only difference being is that the former is electrostatic while the later is electromagnetic. One device transforms radio energy coming from a man-made transmitter to sound while the other transposes electrical particles from natural transmitters into heat, light, or electrical power.

*or synthetic*

- X



# Table of Contents

<b>BOOK DEDICATION</b>	<b>ii</b>
<b>LIST OF FIGURES</b>	<b>iv</b>
<b>INTRODUCTION</b>	<b>v</b>
<b>SECTION 1</b>	
<b>ATOMOSPHERIC ELECTRICITY</b>	<b>1</b>
<b>SECTION 2</b>	
<b>THE WIRELESS TELEGRAPHIC CONNECTION</b>	<b>3</b>
<b>SECTION 3</b>	
<b>T. H. MORAY'S CIRCUITRY</b>	<b>7</b>
<b>SECTION 4</b>	
<b>EARLY DEMONSTRATIONS</b>	<b>11</b>
<b>SECTION 5</b>	
<b>MY RADIANT ENERGY RESEARCH</b>	<b>31</b>
<b>SECTION 6</b>	
<b>ION VALVE CONVERTER TECHNOLOGY EXPLAINED</b>	<b>35</b>
<b>SECTION 7</b>	
<b>MODERN RADIANT ENERGY CONVERSION SYSTEM</b>	<b>37</b>
<b>SECTION 8</b>	
<b>TREATISE ON MATTER &amp; ENERGY</b>	<b>43</b>
<b>SECTION 9</b>	
<b>ALPHA FUSION</b>	<b>49</b>
<b>SECTION 10</b>	
<b>THE TRUTH ABOUT NUCLEAR SCIENCE</b>	<b>53</b>
<b>REFERENCE PATENT</b>	
<b>HERMANN PLAUSON - JUNE 9, 1925 - 1,540,998</b>	<b>61</b>



# List of figures

Number	Page
<b>Figure 1 – MORAY'S PATENT DRAWING</b>	<b>7</b>
<b>Figure 2 – SOURCES OF RADIANT ENERGY</b>	<b>8</b>
<b>Figure 3 – BASIC RADIANT ENERGY RECEIVER</b>	<b>34</b>
<b>Figure 4 – ION VALVE</b>	<b>35</b>
<b>Figure 5 – PROOF OF CONCEPT</b>	<b>37</b>
<b>Figure 6 – NATURAL RADIOISOTOPE CHART</b>	<b>41</b>



## INTRODUCTION

---

Radiant Energy is emitted as charged particles from all bodies at a constant rate. The mystery surrounding it will unlock untold amounts of energy. Under the proper conditions, it can be rendered susceptible to the most incomprehensible changes caused by the oscillations, pulsation and surging throughout the universe.

It was discovered by the Curie's that all matter is possessed with radioactivity. It can be shown that radium, barium, uranium, thorium, polonium, vanadium, cerium, molybdenum, zinc, aluminum, etc... will imprint radiographs on sensitive photographic paper.

If an oscillating tank circuit has the <sup>ether</sup> correct impedance, reactance and inductance it will absorb energy from an external oscillating electrical source. Energy is captured. The tank oscillations can be kept alive by establishing resonance with the external source. Therefore, energy is not drawn from the transformer that powers the tank circuit. In the case of the radiant energy receiver, it becomes possible to draw energy from **cosmic energy** with the aid of specially constructed electrical plasma tubes. The implications of my findings to be described in this book are far and wide. What will be revealed to you is a device that will release electrical power from the cosmic energy of the universe and a glorified radiant energy receiver, one that is designed to receive and convert the oscillations that is being generated. This device locks onto the very wheelwork of nature. When properly constructed it should last for many years with very little maintenance, no more than is required for a good radio receiver.

It will be understood that the energy that is being harnessed is not perpetual energy. Everything in the universe eventually returns from whence it came. What is claimed is a device that can extract energy that is contained in the atoms of matter, otherwise known as the cosmic energy of the universe. My research has revealed to me that certain substances can be excited into generating **radiant energy**. A receiver has also been built that will allow this energy to be collected and converted into useful electrical power. Unique ion-valves have been manufactured to achieve high efficiency in the prototypes. Demonstrations will be performed when the prototypes reach commercial value.

It must be stressed here that the final development of the generation, production, transformation and utilization of radiant energy from the reserves of cosmic energy is not yet complete, but rather a first attempt at commercialization. This book is being published to insure that the technology does not become lost.

"Electric power is everywhere present in unlimited quantities and can drive the worlds machinery without the need of coal, oil, gas, or any other of the common fuels." – *Nikola Tesla*



# Atmospheric Electricity

*We have succeeded in penetrating many secrets of Nature. Because of this we have an obligation to honor her abundant miracles with care and respect.*

Since the time of Benjamin Franklin and his famous kite experiments not much has been learned about the nature of electrical charge and how to convert it into useful power. Certain people have discussed this to some extent. Some theoretical papers in the so-called "free energy" field have been written. Many of these theorists will even consider that ionizing particles from natural reactions can be utilized to produce usable amounts of electrical power. They are determined to cling to their own wild unproven theories.

Nevertheless, I have taken it upon myself, with great personal conviction to find a solution to converting kinetically ionized matter (radiant energy) into useful electrical currents. The properties of radioactive matter have shown me that large quantities of energy can be collected and converted. I have found with the correct circuits and components, that ionizing particles can be efficiently transformed into useful electrical currents. It is my desire to be able to furnish irrefutable proof of this discovery. To begin this journey, scientists and researchers alike will have to snap out of their state of denial. The utilization of ionizing energy on completely new ground has to take place.

The production and utilization of energy obtained from natural sources for the well being of humankind has been the goal of scholars and researchers for countless years now. However, the implementation of a practical working device has remained a pious desire. This is because well-intentioned researchers turn away from the simple fact that there is free electricity to be obtained from natural ionizing sources. I have come to realize through my investigations and observations that this form of energy can be collected in large enough quantities. It can be converted into useful power.

Many researchers after investigating atmospheric electricity become astonished when they realize that there is nothing new in the world. They find out that this form of energy has been with us for a very long time, even before the knowledge of electricity. The wisdom of the effects and utilization of atmospheric electricity dates back many thousands of years, as we can infer from biblical text. We read in the first book of Moses, that the all-holiest temple of Jehovah housed the Ark of the Covenant. With the exception of the high priests, this Ark would kill anyone getting too close to it. Furthermore, we read that 40 priests dared to approach the Ark, in the absence of Moses and Aaron. Lightning issued out from it, killing all 40 priests.

It is written in the second book of Moses, Chapter 25 verses 10-11:

10. Frame an ark of acacia-wood; the length whereof shall be of two cubits and a half (45 inches): the width, a cubit and a half (27 inches): the height, likewise a cubit and a half (27 inches).
11. And thou shall overlay it with the purest gold within and without (exactly like a capacitor).



The biblical text cited indicates that the Ark was made out of a noble wood that acted as a good electrical insulator, and that gold was to be laid inside and out. Thereby, all conditions were just right for creating a good electrical capacitor. From the description we can tell that Moses and Aaron knew how to collect charged particles from the atmosphere. This Ark of the Covenant could only have been a very large capacitor with a huge electrical capacity. It was charged by atmospheric static electricity from the accounts given. The fact that it remained fully charged with only atmospheric electrostatic energy must be attributed to the dry climate in Palestine. Knowledge of this energy was a coveted secret kept by Moses and the high priests of Egypt. They were the first connoisseurs of static electricity.

When the study of meteorology first began there was a big interest in atmospheric electricity. Many in this field thought to use it. This is revealed through the patents of the time. The first relevant patent was granted to inventor Dr. Heinrich Rudolph of St. Goarshausen, according to the German Patent Office; D.R.P. No. 98180 January 19, 1897.

Benjamin Franklin in America made a few attempts to utilize static electricity obtained from the atmosphere. He once built a motor that implied a commercially significant amount of energy might be derived from the earth's atmosphere. It has been observed that an average potential gradient of 150 volts per meter of height is always available.

There are three major causes of atmospheric ionization shown in **Figure 2**. The first one is due to the cosmic rays and the second cause is due to the solar winds. The solar winds consist of 96% protons and the remaining percentage contains atoms of tritium. There are other particles but they are relatively unimportant. Almost all of these high-energy particles are absorbed by the earth's upper atmosphere causing it to become ionized. This is why the upper atmosphere is called the ionosphere. However, the area where the reaction between the solar wind and the magnetosphere takes place is far outside of the earth's atmosphere. The charged solar wind particles rattle our planet's magnetic cage long before its gas envelope neutralizes them. The third cause of atmospheric ionization is due to the content of radioactive gas contained in the air that we breathe. In the ground radioactive substances such as radium, thorium and actinium are spread throughout the soil. These elements generate gaseous radioactive emanations that spread in the air and ionize its molecules. The actinium-emanation generated from the decay of U235 plays a major role because of its brief radioactive half-life of only 3.9 seconds.

## **Radio Ionics**

There are not enough charged ions in the air to be converted into electrical power. This on the surface appears to be a correct calculation and assumption. There simply are not enough of them. However, these ions are in a state of constant surging motion. By studying this particular sea of energy we can gather clues to obtaining power from its charged particles. The ions in our atmosphere are in constant motion. To obtain electrical current from a generator the magnets must also be in constant motion. Do you see the correlation here? What we learn is that charge in motion **induces** electrical current. By means of a properly tuned radio-ionic-circuit a solution to harnessing this seemingly static charge presents itself. Hermann Plauson was successful in converting atmospheric energy into useful electrical currents. He was granted a patent titled "Conversion of Atmospheric Electric Energy" – U.S. Patent No. 1,540,998. In his patent he states, "St. Elmo's fire and the northern lights can be more or less absorbed in the same way as a receiver in wireless telegraphy absorbs waves coming from a far distance". His patent has been added to the end of this book. This patent begins on **page 61**. Study it carefully. It contains the foundation to building a powerful radiant energy power-receiving device.



## The Wireless Telegraphic Connection

Radio in the early years was called "wireless telegraphy". Beginning around the year 1913, amateur wireless telegraph stations were set up in trees and on housetops. Aerials and masts dotted the countryside. It is estimated that there was almost "a quarter of a million stations". They were used to send and receive wireless telegraph signals, not voice. Vacuum tubes were not yet widely known. These stations had to rely on spark gaps.

It was the energy spikes, or surges that the spark gap transmitters generated that first caught T. H. Moray's attention back in 1903. In 1909 Moray devised a circuit that would draw electricity from the surges of energy that were thought to travel through the ground. By the fall of 1910 he obtained enough electrical energy from the ground to power a miniature arc lamp. During the Christmas holidays of 1911 he was able to power an old type 16-candle carbon arc lamp at about half of its normal brightness.

In 1912 while Henry Moray was on mission with the Mormon Church in Uppsala, Sweden, his passion for crystal radios got him started in his research in the science of radiant energy. Every spare moment he searched for a mineral that could work as a good radio detector. Moray had found two specimens that worked well as radio detectors. The material that he found in the hillside could have very well been a type of **argenti-zinciferrous-galena**. This type of galena is highly sensitive to radio waves that would have allowed his receiver to function without a battery. My finding here is based on the fact that Moray describes a synthetic galena type formula in his Electrotherapeutic Apparatus – U.S. Patent No. 2,460,707. This material could have used only the power transmitted from a local wireless station to drive a small horn speaker as he has reported.

The other detector material was a white, powdery, stone-like material that he found in a railway car, located in Abisko, Sweden. Military Contract No. F42600-75-2212, Hill Airforce Base, Ogden, Utah, Final Report dated April 15, 1977, page 4, 2.6.2, indicates that it contained a small amount of crystallized silicate but consisted mostly of "**fused silicate**". Silica is the chemical name for the simple oxide of silicon, silicon dioxide ( $\text{SiO}_2$ ). Mineralogists call this compound **quartz**. This is normally found in nature in its crystalline form. What Moray could have found is quartz in a **metamict** state. Metamict minerals are formed when a crystalline mineral loses its crystalline structure due to radioactive destruction. It must contain at least impurity amounts of uranium and/or thorium. In its metamict state, quartz is in a more or less amorphous state, owing to radiation damage from  $\alpha$ -decay. "Over the course of hundreds of millions of years,  $\alpha$ -decay doses as high as  $10^{19}$  decays/g can occur, which may lead to the complete amorphization" <sup>(1)</sup> of the quartz structure. It is also a strong possibility that what he found was an artificial **willemite**. Artificial willemite is a white lumpy substance. Chemically, it is an anhydrous silicate of zinc, having the composition  $\text{ZnO}:\text{SiO}_2$ . When willemite is exposed to a preparation of radium it fluoresces with a fine green glow. The luminosity produced by the proximity of even a small quantity of radium, such as one-thirteenth of a grain, is quite sufficient to enable the time to be read on a watch in total darkness. The luminosity of the artificial substance is, in some cases,



superior to the natural mineral. No matter what the source was we still know that the mineral Moray found was a fused silicate.

Moray's mineral find became known as the "Swedish Stone". He was able to light a standard 100-watt General Electric light bulb in June of 1925 using this material in his circuitry. By August 1925 he was able power an electric flat iron along with a 100-watt bulb. Therefore, bringing the total power consumed to 655 watts. People would quite often demand that he would draw too much power from his device and the white, stone-like material would overheat and burn up.

The Federal Radio Commission on Nov. 11, 1928 limited the amount that could be transmitted from telegraph stations. Because of this Moray's energy device could no longer generate high wattage. His device depended on these stations to excite the Swedish Stone into giving up its energy. Scores of spark gap driven telegraph stations had to be dismantled and in effect had been given death sentences. This spelled disaster for Moray. His device would still generate power but the amount of power that it generated was restrained. Originally, Moray's device had relied on the telegraph stations to excite it into generating electrical power. This forced him to find another way to excite his circuitry. Moray could utilize the natural radio energy generated by the cosmos but unfortunately the end result was only very low power at the time. This forced Moray to develop a more sensitive detector material. It was not too long before he got the inspiration to add ionizing radioactive substances to his active circuit components. This new material was also put into quartz tubes in a controlled environment so that it would not oxidize and burn out. This line of research occurred shortly after the Radio Allocation Act of 1928 when Moray's detectors were no longer able to generate steady power. His Radiant Energy circuitry could still produce power but it only did so in pulses. The power was not constant. The addition of radioactive impurities allowed the production a steady flow of energy.

### **Radiant Energy Early Definition**

Professor Langley showed that out of the total amount of radiation coming from the sun, that the visible portion represents only 19% of the spectrum. He presented the theory that there is only one kind of energy radiated from sunlight. That, heat, and chemical effects depend entirely upon the state or condition which radiant energy may happen to fall on matter.

Professor Langley wrote that up until 1872 it was almost universally believed that there were three different kinds of **entities** – actinic, luminous, and thermal. These are what make up the spectrum. He reasoned that there is only one radiant energy that appears to us in the form of "actinic", "luminous", or "thermal" radiation, according to the way we observe it. Heat and light, therefore, can not be things in themselves, but separate sensations to our bodily sensors. They are merely effects of this mysterious thing called "radiant energy".

The Italian physicist Melloni stated that, "light is merely a series of caloric indications sensible to the organs of sight, or vice versa, the radiation of obscure heat are veritable invisible radiation of light". Melloni wrote this in 1843, but it was not adopted until Langley by his elaborate researches, more refined and complex, that proved it. The great physicists of society then adopted the doctrine of one radiant energy.

Only a few researchers know that the immediate effect of radiant energy is electromagnetic. The results of two centuries of observation all point to this conclusion. When a mighty tongue of white-hot matter darts across the abyss of a large spot or cavern on the sun, the equilibrium of the earth's magnetic field is disturbed and the effect is a magnetic storm. The needle of any magnetograph throughout the world will quiver and oscillate. These vibrations pass from the sun



to the surface of our planet that is closest to it. These impulses then pass to the most distant side, whether through or around the planet's surface.

After centuries of investigation from Gilbert to Tesla, this most wonderful research still holds admiration and mystery for all that study this vast science; electrodynamics. Power is cut out of the seemingly emptiness of space, and the hurrying waves are caught and chained to servitude in artificial light and electric appliances. The sun, being electromagnetic, emits waves that carry power, which beat and surge against the earth. A magnetic field is space that surrounds a magnet. This space might be filled with air, wood, stone, glass, or might be a vacuum. Nevertheless, the waves are not quenched. They flow through all of these things. A freely suspended magnet in a magnetic field will move, and the earth's surface is surrounded by a magnetic field, that is acted upon by the sun's magnetic field. Suspend a sewing needle by a silk fiber in the earth's magnetic field and it will come to rest parallel to the field's north and south poles. Now, if this field becomes disturbed, that is, if it becomes stronger or weaker, the needle will move. This is a magnetic storm. When a gas jet is hurled across a spot on the sun the disturbance reaches the earth in the same time that light does. Therefore, the radiance travels at 186,000 miles per second reaching the earth in eight minutes and nineteen seconds.

The most memorable magnetic storm occurred on November 17, 1882. This was one of the most violent recorded. The daily press was burdened with accounts of widespread magnetic disturbance. In some places telegraphic communication was suspended. The turbulence stretched from New York to Yankton, Nashville, and Winnipeg. In Milwaukee, the carbons in the electric lamps were lighted, rendered incandescent by currents of electricity flowing on the wires. At other locations, switchboards in telegraph offices were set on fire and sending keys were melted, while electric balls were seen hovering on the telegraph lines in Nebraska.

The earth's aurora holds the key to harnessing the sun's daily pulsation. An aurora is the visible effect of obscure undulations from the sun, as they come dashing on the earth with a speed of 186,000 miles per second. In a six-month winter, say at the North Pole of the earth, where the sun is far south of the equator, and none of its rays can shine on the earth's northern pole, the aurora is very bright. It displays many colors, and these flash and glow with rapid variations. The light, although caused by the sun, does not come direct. It is caused by the turbulence set up in the earth's magnetic field by electromagnetic upheaval on the sun. The field of the earth is "tuned" with the sun's field, as was the coherer in the days of wireless telegraphy and telephony. The aurora is known to be electrical, for magnets and compass needles on ships are always affected. Could the coherer of the days of old teach us something new?

No magnet can be placed near a "current" of electricity, or a static charge without making an oscillation. Every oscillation sends out a wave, like a stone falling in water. An electromagnetic wave from the sun disturbs the earth's magnetic field in the same way that an induction coil used in wireless telegraphy does. The earth and coherer are both doing the same thing with the same kind of electromagnetic waves. The coherer in a distant receiving station will react to natural electromagnetic wave fronts from the sun. It will likewise react to the artificial wave fronts coming from the induction coil. The electromagnetic wave makes the loose particles of metal between the knobs in the glass tube coherer generate dots and dashes.

Finding a really efficient component to detect natural radio waves is no easy task. Today's state of the art crystal diodes are still not where they could be. In my opinion, T. H. Moray's synthetic semiconductor that was housed in a controlled environment was the perfect detector.



Moray found that certain semiconductive materials that he doped with radioactive impurities displayed an increased sensitivity. One such satisfactory formula included a triboluminescent zinc mixture consisting of pure zinc sulfide, radioactive impurities and pure germanium metal. He also found that "artificial radiation" could be used in place of the radioactive impurities. For example, by exposing bismuth to radon gas and charging it with a negative charge of a thousand volts or better "active bismuth" is created, today known as Polonium-210. When added to the zinc sulfide it would glow a bluish-green. When this glowing material was then doped into ultra-pure germanium it made an excellent emitter of secondary electrons. This synthetic substance was called "fission material" by Moray.

"The Moray germanium mixture gives certain unique results in functioning as in a valve and or booster (amplifier). Made in form of rounded stones or pellets compressed under high pressure and fused. Combination contains **radium chloride, thorium, uranium, and pure germanium metal-triboluminescent zinc**. Some pellets fastened to envelop with pure tin in place of solder. Bismuth pellets fused to side. Germanium mixture pellets float between other pellets but making firm, needlepoint-like contact. Have used silicon too, which has some of the properties of germanium. Germanium works best when impurities are introduced. Care must be taken when alloyed with other substances, as too much other mixture added worsens conductivity and germanium loses its properties." \* T.H. Moray, fifth edition, *The Sea of Energy in Which the Earth Floats* (1978), p. 71.

I had often asked myself, what ever became of Moray's radiant energy tubes? Wouldn't it be nice to run some tests on them? Well, as fate would have it I have had the opportunity to test some of his tubes. I now possess several of Moray's tubes that he used in his research. Many years ago a man named Stan Mahurin obtained a steel case loaded with Moray's experimental vacuum tubes and a notebook from his widow. This man knew T. H. Moray and his wife quite well.

Mr. Mahurin passed the tubes onto Dr. William A. Rhodes, "a close friend for many years", because he had no clue as to their function but did insist on keeping the notebook. The tubes were a big mystery to Rhodes and he had them stored away for over twenty-five years. I was contacted because of my passion for radiant energy research and was given the opportunity to purchase these tubes. I promptly replied and have had the honor to inspect them first-hand.

Upon inspection of the tubes there is no outward sign of radioactivity. None of the tubes indicate the presence of radioactivity when approached with any of my radiation sensing meters. Several of the tubes contain a cylindrical anode and wire filament. I concluded that these tubes were used to rectify the received radiant energy waves. They had to have been the tubes that Moray used when he ran out of his Swedish Stone mineral. None of the tubes that I bought from Dr. Rhodes turned out to be of any real importance to my research. However, they do hold historical value.

I am now attempting to rebuild a radiant energy device that will demonstrate a few hundred watts of excess power above what the circuits require to be self-sustaining. My next goal will be to develop a 1000-watt device and then I will proceed to build a commercial unit.

1) Miami University, **Herbert Jaeger** Physics



## T. H. Moray's Circuitry

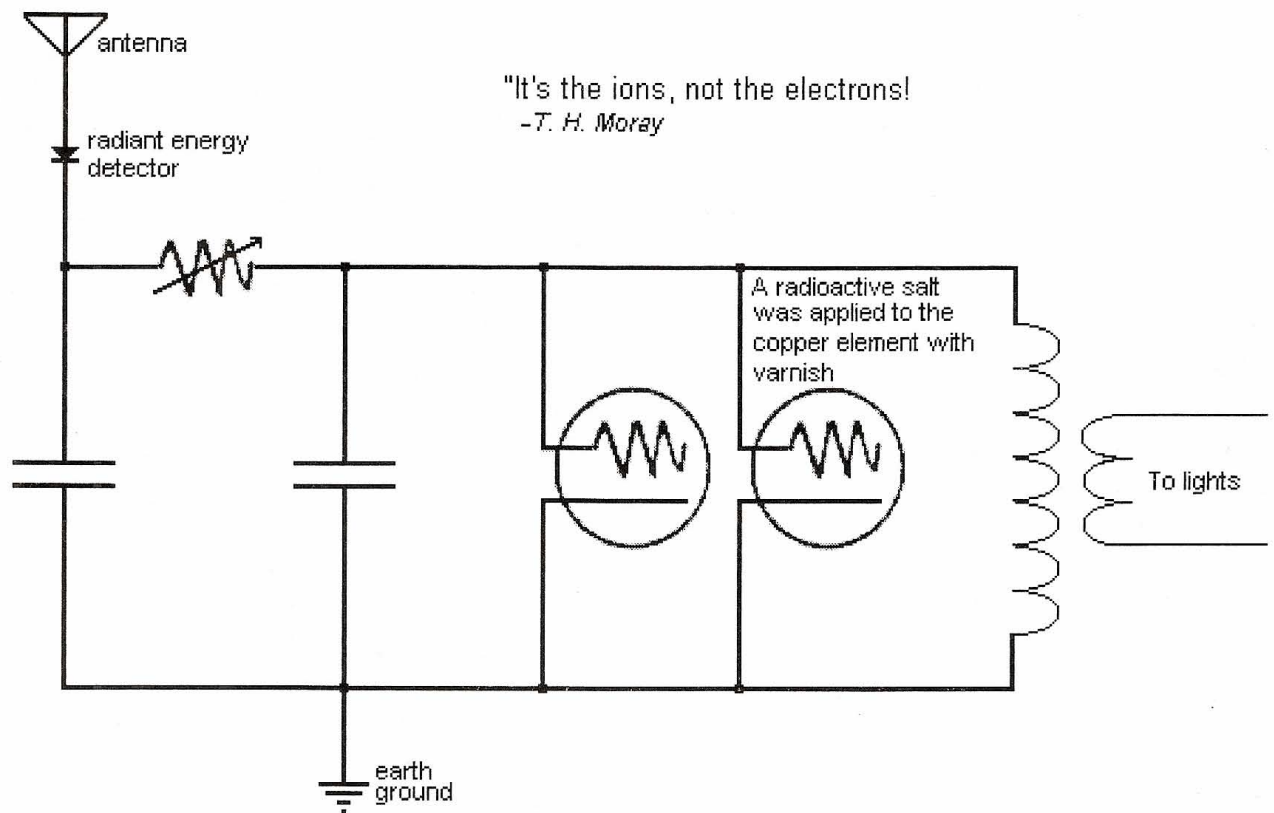

**Moray's Patent Drawing - Figure 1**

On January 1st, 1954 Carl Betz drew this circuit from memory after visiting Moray's lab and seeing patent drawings that were never filed.

It is assumed that the average reader of this publication is familiar with the elementary principles of radio transmission. Granting this, it is of course reasonable to believe that such readers will understand how an oscillating current is set up in a circuit comprising an inductance or coil of wire, a capacitor and a spark gap. The capacitor is charged with a high tension current from any convenient source such as a transformer or induction coil. When the potential stored in the capacitor reaches a critical value, the air in the gap between the spark gap electrodes can no longer stand the strain. The capacitor discharges across the gap in a succession of crashing sparks. As the current from the capacitor crosses the gap in one direction, it literally over-reaches itself just as a pendulum will swing past the neutral point when given a push by the hand. After the first rush of current passes in one direction, a reversal of the cycle occurs and a second rush in the opposite direction occurs. This operation is repeated many thousands of times per second. The discharge gradually dies down as all the energy is either completely radiated or used up in heat or in performing work. These oscillations cease once the potential across the capacitor has been lowered until the spark can no longer jump the air gap. The capacitor immediately takes a fresh charge from the transformer and the entire cycle of operations is repeated. It will be understood

that all of this passes in an infinitesimal fraction of a second. The charge and discharge of the capacitor takes place so rapidly that the observer can detect no change in the solid spark that appears continuously to fill the gap. It should also be understood that if this oscillating tank circuit has the correct impedance, reactance and inductance, it could absorb energy from an external oscillating electrical source with the correct conditions met. Energy would therefore be captured. The tank oscillations can be kept alive by establishing resonance with the external source. In the case of the radiant energy device the external source is drawn from a field of radiant energy that the ion-valve power tube generates.

What is being explained within this publication in my opinion is the "Holy Grail of Energy". The implications of this discovery are far and wide. Is humankind ready for such a revolutionary discovery? The radiant energy circuitry locks into the very wheelwork of Nature. This device should last for many years with very little maintenance, no more than is required for a good radio.

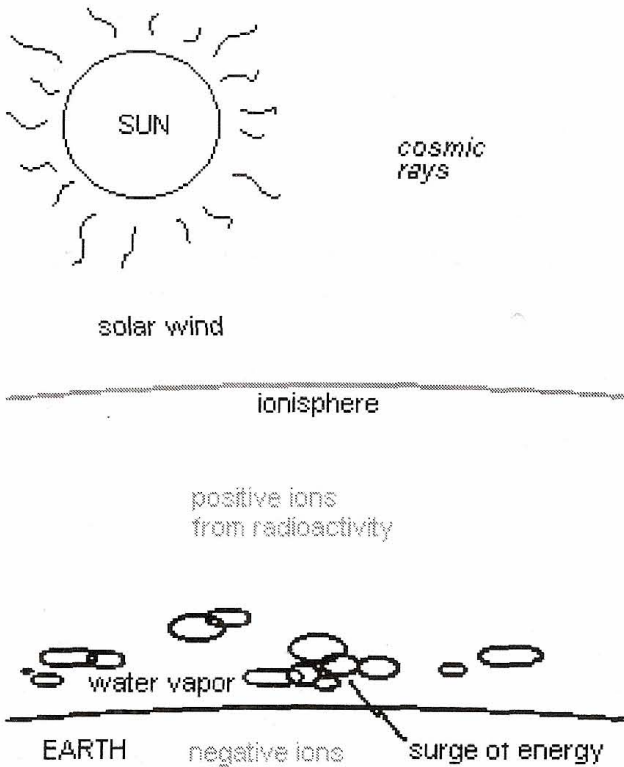

### SOME FACTS TO THINK ABOUT

1. Cosmic particles are hurled at the earth from outer space.
2. The sun emits ionized **protons** and **tritium** atoms that are carried to the earth by the solar winds 24 hours each and every day.
3. The earth's upper atmosphere absorbs the charge carried by the particles in the solar winds causing it to become ionized.
4. The earth's ionized atmospheric region is called the "ionosphere". It is sort of a half gas and half plasma.
5. Water vapor (clouds) become charged by induction as they travel parallel to the ionosphere.

### Sources of Radiant Energy - Figure 2

6. When clouds become sufficiently charged they will discharge according to Pupin's theory of capacitive discharge. The energy is released in the form of light and electrical oscillations.
7. There is a cloud discharge about one hundred times each second that is randomly located somewhere on the planet, generating a tremendous amount of natural oscillating electrical energy. The total energy per discharge is documented to be approximately "**two million-million watts**". <sup>(2)</sup> Now multiply this figure by one hundred lightning strikes every minute and unbelievable amount of unleashed energy presents itself.

2) Exploring Light, Radio & Sound Energy by Calvin R. Graf, p. 74



## Moray's Radiant Energy Detector Tube

T.H. Moray invented a very unique energy-generating component. He called this discovery, the "radiant energy detector valve" (R.E. valve). It was excited by radio frequency energy. It contained solid-state semiconductors "mounted under ideal conditions".

This Radiant Energy valve contained Moray's fission material. It replaced the original Swedish Stone. Its anode acted as a collector made with a molybdenum disulfide rod. The metal case served as a parabolic reflector to concentrate and focus the secondary ions that were expelled from the fission material.

The radioactive elements within Moray's fission material emitted waves of separate and distinct units called photons. There were definite relationships between the energies of these particles and the zinc sulfide (triboluminescent zinc) germanium mixture, contained in Moray's formula. The zinc sulfide in the mixture was highly sensitive to the photons generated from the fission material.

\* - The sulfide transformed the high frequency photons into lower frequency photons. These photons then **impinged** upon the germanium. The germanium being sensitive to these lower frequency photons emitted secondary photo ions. The hemisphere that contained the active materials was filled with a low-pressure water vapor and was comparatively simple in construction.

R.A. Tube

- \*

R.A. + zinc + chlorine = elect.

Thomas Henry Moray successfully demonstrated his electrical device that **weighed less than sixty pounds**. It extracted enormous amounts of energy, **four thousand watts** to be more exact. This unconventional source of energy is abundant day or night throughout the year. To understand how this device generated energy, you must carefully read the material contained in this book. I have compiled this information to assist you in understanding radiant energy power generation without giving away the entire contents of the discoveries.

On the introduction page in the "The Sea of Energy in Which the Earth Floats", 4<sup>th</sup> edition, Moray explains that radiant energy is kinetic in nature. He states that it is rendered sensible by the conversion of its energy. He then states that "this is the phenomenon of the transducer fueled by a fission reaction. In the final analysis, radiant energy is a means of using the energy released by the fissionable reactions taking place in the stellar crucibles of the universe". Moray in his second edition, on **page 61**, describes the "universe" as being both stellar and atomic. The final clue to the inter-most secret of Moray's energy device is found on **page 33** in this same edition: "It is an accepted fact that when various substances are bombarded with alpha particles they are found to give off **electrons**". How much clearer can this be? He goes on to state; "just as sodium, potassium, cesium, rubidium, barium and strontium react to visible light or wavelengths within a certain range, might not certain other substances react to oscillations from the Cosmos or artificially produced radiation"? We now know that that **silicon** and **germanium** will emit electrons when alpha or beta particles impinge upon these semiconductors. Moray knew this back in the 1920's! He also states that "the universe is analogous to a radio transmitting station. It is continually emitting energy, only of a greater range of wavelengths".

What is revealed within this publication should clear a path to the understanding of Moray's radiant energy device for you the reader. It will be shown that energy emitted from the artificial transformation of matter (cosmic energy) can be directed to produce intense surges of radiant energy. More clearly, the radiant energy (radio noise) that is artificially generated from the transformation of matter is converted from its ionic state into electromagnetic energy. The conversion from ionic to electromagnetic energy can then be transformed into useful electrical power through tuned radio circuitry.

- \*

## Electronics vs. Ionics

The earth's electric field that exists between the surface and the ionosphere is charged to about 360,000 volts. It is estimated that the stored energy ranges from about one million to a billion kilowatts. This field provides a low current at a high voltage and will not power today's appliances because they use high current, low voltage electromagnetic power.

In 1748, Benjamin Franklin was the first to invent an electrostatic motor that could run on the earth's energy field. Did this scientist of yesteryear point us in the right direction?

Thomas Edison's 1880 discovery of thermionic emission, the current of electron flow in a vacuum tube, created the first electronic device. Sir William H. Preece called this the "Edison Effect". Edison had discovered the fundamentals of the electron tube and was granted US Patent No. 307,031. Its' basic principle was to be used in radio communication for many years to follow.

At the Paris Electrical Exhibition of 1881, Professor Amos Dolbear successfully demonstrated his electrostatic transducer for the telephone. He obtained US Patents No. 239,742 and No. 240,578 for this invention.

In 1887 Dolbear was forced to go to court against Alexander Graham Bell to establish that he was the inventor of the telephone. Dolbear lost this infringement case. The judge consequently ruled that Bell was the inventor of the telephone. This decision was the pivotal point of our electrical development. Because of this one decision by a court, inventors moved in the direction of electromagnetic driven components.

Conventional radio tubes to this day are based on electron emission. Electron flow through a vacuum tube is where we get the word "electronic". If science had gone the way of ionic emission instead of electron emission in radio tubes I believe that our technology would be drastically different today.

\* — I have designed radio tubes that carry ion current instead of electron current. Vacuum tubes that carry electrons are called "electron valves". My tubes carry ions and therefore are called "ion-valves". This changes everything about inductance and capacitance. Capacitance then becomes the essential element in electron transfer through the associated elements. It may be of interest to you that "ohm's law" only applies to conventional electron tubes. In a conventional electron tube the mean velocity of an electron is about 1 cm per second. In my (ion tube charge transfer) is much faster. When using the ion tube as a rectifier or oscillator this changes the whole mathematical equation on its electrodynamics.

\* — T. H. Moray's tube oscillators were actually ion-valves. (This is what allowed them to run cold.) There are many foreign seas of energy that we might venture to sail. There are indeed more seas yet to be discovered. Sailing another uncharted course in the modern world is not just a wild dream. This publication is proof positive that a new technology is just on the horizon.

There can be no doubt now that I have opened the door to a revived energy revolution. I now ask that you shout from your rooftops the information that you have gleaned from this book. This will give me the credit and recognition that my work deserves. This in turn will lead to the commercialization of the technology. It is my ultimate goal to offer self sufficient energy systems to a network of communities throughout the world. It is my hope that these systems will better the quality of life here on our planet.



## Early Demonstrations

What follows are accounts given by observers of the T. H. Moray radiant energy device that utilizes the vast stores of energy in the matter without mechanical force, but through **ionic oscillations**. The statements have been edited for clarity without changing the meaning being conveyed.

### A brief description of the device

A brief description of what the device has done will be given. Successful demonstrations will also be described like those that have been made in the presence of hundreds of reliable witnesses, many of whom were highly trained and held degrees in physics and electrical engineering. There will be a brief description of why the device worked based on the oscillations of condensers. I do not believe in perpetual motion. I have no quarrel with those who do. The operation of the Moray device is **not** perpetual motion. It utilizes energy that exists in matter and transforms it into useful forms. The electrical generator is not really a generator, as it creates nothing. The generator does not make electricity. It merely pumps it. From that standpoint, an electric generator might be referred to as an ion or electron pump. The Moray energy device might be called an **electric siphon**, or high speed-oscillating turbine.

T. H. Moray's device was enclosed in a box 10 x 10.5 x 26 inches, one wire leading from the device to a special balanced antenna. Another wire was connected to a balanced ground connection.

In my own device, a special ion-valve is used to excite an electron emitter into giving up its energy. The device is adjusted so that a synchronized resonance is established. Once it is operating, the device "siphons" energy. A radio frequency transformer is used to control the circuitry. Any desired voltage may be obtained.

On **page 17** of the "Nature of the World and of Men" (compiled by the technical staff, Chicago Institute of Technology), we learn that our planet is receiving energy from the sun continuously at the rate of 160,000 horsepower per inhabitant.

In the "Physical Review", Dr. Gunn of the U. S. Navy Research Laboratories states that the earth itself is a huge dynamo, producing 200,000,000 amperes of electrical current. For more detail, read **pages 334 - 344**, "Physical Review", July 15, 1939.

The Aurora Borealis definitely is considered an electrical phenomenon produced by the passage of electric charges through the rarefied gases of the upper atmosphere.

The conversion of matter to energy in the stars is now generally accepted as fact. During radioactive disintegration energy waves are radiated. Thus, we may conclude that energy waves of very high frequency are sent out from the stars, one of which is our sun.

Similar to the reception of radio waves, a radiant energy power receiver can be tuned into resonance by the right arrangement of inductance and capacities. The components respond to the particular wave

frequency "oscillations" of energy from the Cosmos. Moray used a unique diode that prevented the return of power to the outer circuit and forced it to go through the R.E. valve.

All that is necessary to put the device in operation is to start electric oscillations in the circuit due to a surge of high potential between the antenna and ground connections of the device.

The frequency of the current is extremely high, as is shown by the brush discharge when either the antenna lead or the ground wire is disconnected from the machine. Certain difficulties of insulation that is inherent with high frequency currents are avoided by the ingenious operations of the oscillator tubes that reduce the frequency on the output side.

Standard electric light globes become exceedingly hot on one spot that is about the size of a dime when operated on this current. This is due to the fact that the gases in the globes become incandescent under the influence of the very high frequency current. The luminosity of the incandescent gas is also much higher and whiter than with ordinary current. A variation of the Tesla, high frequency, button type globe would be ideal for use with this device.

Ordinarily, when a potential is applied to the terminals of a condenser, a full charge is acquired almost instantly. The filling up of Moray's oscillator tubes is similar to water being poured into a bucket. That is, the longer the voltage is applied the greater the charge that is taken, up to the maximum capacity for a given potential and frequency.

R.E. experiments have been made at different places, many miles from all power lines. One experiment occurred more than 50 miles from any power line and 26 miles from even a farmer's telephone. The locations for these experiments were selected by those making the test and not by the inventor. These locations were not prearranged but selected as they drove along in their own car, not the automobile of the inventor.

In an endurance test, the device was operated under seals for a total of 157 hours and 55 minutes. Then the seals were broken and the device was put under severe strain and tests for about another hour and then shut off.

Close examination of the device, showed that all parts were in perfect shape and could have been run indefinitely. During the entire test the light burned evenly and brightly without flickering. There was no change in the brightness from day to day.

The quantity of current passing through the secondary of the transformer, experts have asserted, is sufficient to burn up similar wire if ordinary current was used. Yet, there is no heating of the transformer, even though cooling air was not present, as it is completely enclosed. All parts of the machine run absolutely cool regardless of the length of time operated.

It makes no difference whether one 50-watt lamp is used or whether fifty of them are connected to the machine; the current is adapted to the load.

This current has another physical characteristic as seen in the photographs of light bulbs operated by the radiant energy (R.E.) device. The photographic images of such bulbs are extremely bright. So, the emulsion density in the area of the bulb image is extremely low, virtually zero. If one takes a photograph of the original print the resulting film has the same characteristics. Prints made from this second film have these same characteristics as well. The light bulb images have such extreme low density that one has to reduce the exposure of other parts of the image in order to get a satisfactory



picture. Yet the light from the R.E. device is whiter and less harsh, even to stressed eyes. Here is further evidence that this current is different from any coming from conventional sources in use today.

There is no sound coming from the machine when it is in operation, there being no moving parts, electrical oscillations or prime mover operations.

The current cannot be derived from batteries, as it can be shown. Doctors of Physics have pronounced this current to be high frequency. Only an alternating current has these properties. Batteries provide only direct current.

It cannot be induction from adjacent power lines, as an induced current is always the same frequency as the inducing current. There is no power line on earth carrying current of these frequencies. This current cannot be caused by radio signals alone; these are much too weak. To operate a loud speaker, it is necessary to amplify a radio signal many times, to say nothing of lighting a lamp or heating a flat iron.

Moray stated that when the oscillators are connected to the circuit the condensers fill slowly. The longer the current is applied the greater the charge they take, up to their maximum for the applied voltage. This is similar to filling a bucket by pouring the water into it. The condensers do not take the charge instantly, as is ordinarily the case.

Moray has also stated that the size of wire in the transformer could not carry the amperage passing through it without burning up if ordinary current were used. Yet the wires remained absolutely cool no matter how long the machine operated.

The above points show these currents to be entirely out of the ordinary. They cannot be accounted for by induction from existing power lines or current from batteries.

### **Another short account follows**

Today Mr. Judd, Mr. Adams and attorney Nebeker visited the inventor's laboratory. After the "radiant energy" device was packed into the attorneys' auto, we drove away. The three above-mentioned gentlemen began to discuss where they should go to make the test experiment. The inventor did not want to have any say in where the test was made. He wanted the test to be made at a place selected by them. At last, the three men decided to go up Emigration Canyon, as there are no power lines there. After driving about four miles up the canyon they selected a place. Then they changed their minds, selecting another place a few hundred feet further up the canyon.

Mr. Judd stayed in the car because of an injured foot, while Mr. Nebeker and Mr. Adams put up the antenna and ground. The inventor then took the device out of the car and connected it to the "antenna and ground". The switch on the device was opened and closed many times as in all former experiments, but no light appeared. The device was then "tuned in" as Mr. Judd had witnessed in previous tests. Then the switch was closed and the lights came on. The "antenna wire" was momentarily disconnected. The lights went out but came back on when the "antenna" was again connected to the device. The same thing happened when the "ground wire" was disconnected and then reconnected. All this with Mr. Judd hopping around on one foot, he having gotten out of the car when the tuning process was started. All three gentlemen were very well satisfied and pleased with what they saw. It was dusk when they left the canyon.

## **The following is a letter describing a similar test performed at a different location**

Dear Mr. Cooley,

This letter is being written for your information. It is a record of the electrical demonstration made on October 29th, 1926, by inventor T. H. Moray for Attorney Judd, Mr. Knight and myself.

As prearranged, I met Moray and Judd at the Moray laboratory at about 7:10 a.m. on October 29th, 1926. We carried the electrical equipment in my car and left Mr. Judd's car in the Moray parking lot.

I remember that the odometer registered 19 miles at Charleston and 26 miles as we left the last electric power line near the mouth of Daniel's Canyon. It registered 52 miles when we stopped to do the demonstration. Thus, we were 26 miles from the nearest power line and we were 26 miles from the nearest one wire rural telephone line.

Moray requested that we select a place near a stream of water so that the ground pipe could be sunk in its bed to be more effective. The ground in the mountains, at this time of year, was frozen. We stopped at a place about 10 miles southeast of the Daniel's Strawberry summit and about 200 yards west of the main road to Duchesne. This location was almost due east from what Mr. Knight called Haystack Mountain. It was perhaps  $\frac{3}{4}$ 's of a mile east of Strawberry Lake on a little stream that made a zigzag course through a gently sloping grassy flat.

The antenna wire was put up without any aid or instructions whatever from Moray, as it had been "balanced". Moray did suggest that the wire be stretched tighter to prevent so much sag at its' center. This was done and the wire then appeared to clear the ground by 7 or 8 feet at its lowest point.

### **Operation of the R.E. device**

The balanced ground rod was pointed at the end to make it easier to drive into the ground.

The antenna wire was insulated from the poles with two quartz glass insulators that were about six inches long. A piece of wire about two feet long connected each insulator to the poles. The lead-in wire was fastened to the antenna at a point about 10 or 15 feet from the east pole. I helped Moray solder the connection where the lead-in wire was fastened onto the antenna wire. I also helped him solder the ground wire to the rod. I stepped the distance between the two antenna poles and estimated it to be 87 feet as I took 29 steps that were intended to be three feet each.

Moray took his electrical equipment out of the automobile and placed it on the running board of the car. Two dry boards were laid on the ground and a rubber mat from my office was placed on the boards for Moray to stand on. This was as a precaution against electric shocks. The running board was hardly large enough for the equipment so we took the seat cushion out of the front seat and placed it on the mat. Moray transferred the equipment to the seat cushion and connected it up there.

Very light snowflakes fell occasionally and a tarpaulin was hung over the top of the car doors to protect the equipment from getting wet. Then all of the wire connections were made and the device was synchronized in resonance by Moray. It was just 1:05 PM by my watch. Before "tuning in" he closed the switch but no light appeared. After "tuning in" for slightly more than 10 minutes the switch was closed and the light appeared immediately. It was slightly after 1:15 PM by my watch. Moray closed the switch two or three times before and during the tuning operation but no light appeared until perfect "balance" was established.



While the lights were burning the antenna lead-in wire was disconnected from the apparatus. The lights went out. When reconnected again, the lights reappeared. Moray disconnected the "ground wire" and the lights went out. He then reconnected it and the lights appeared again.

E. C. Johnson of Salt Lake City, Utah signed the above letter.

**Mr. Nelton Welling wrote this letter, describing yet another test**

Your interest in the Moray invention to take electrical energy from the "air" and make it usable for light, heat and power purposes is the reason for this letter. It describes a demonstration that I saw of his device on Saturday, February 21.

A dozen people were present, including Paul Harsh, Mark Yuri and Mr. Ferguson.

I first witnessed a demonstration of this device three months ago. Since then, the cabinet containing the machine has been simplified and improved. It was quite apparent that there was no possible faking of the power produced.

The tuning device was improved. The time required to bring in the energy was shortened from five minutes to less than a minute.

The operation was as simple as tuning in a well-equipped radio set. A lady who witnessed the demonstration for the first time also performed this tuning. She operated the device as easily as Dr. Moray himself did. This was after she had seen him "tune in" the energy.

A pilot light on the cabinet first became illuminated. The switch was then closed, connecting a light rack with the current. Instantly thirty 50-watt lamps and five 100-watt lamps were brilliantly lit.

A regular, Hot Point flat iron was then connected without dimming the lights in the least. The inventor stated that the result would have been the same had one hundred lamps been used in place of the 35 on the light rack.

The lights and iron together were consuming more than four-horse power of electric energy.

On account of the brilliancy of the lights it was apparent that much more than ordinary voltage was going into them. The excessive heat, which developed on one spot, made me feel that they would soon burn out, but they did not.

I confidently believe that Dr. Moray is on the threshold of perfecting one of the most amazing fundamental inventions of history.

Very sincerely yours,

Nilton H. Welling

**The following is a lengthy report that was written by T. J. Yates to the Secretary of Utah**

Dear Secretary of the State of Utah,

Many men of science have come from foreign countries and from the East and the West and have been shown demonstrations. Not one of them has been able to find any fault with what they have seen or heard. Names of these men will be furnished upon request. These men have had the device opened for their inspection. They have pronounced the experiments to be wonderful, that the current is high frequency, the color of the light different, that the device carries many times as much current without even getting slightly warm. Any other electrical device of like construction, known to man, would burst into flame if it were carrying that much current. They state that the "tubes used are far more powerful than anything known to science today". The drawings, circuits and theory have been pronounced by leading men of science as scientifically, electrically, mechanically sound and correct.

It is generally accepted now by science. Moray's device proves there is energy coming from somewhere, that such a field of energy surrounds the earth.

As Moray explains it, the oscillator tubes pick up electrical oscillations through the circuit of the device itself. As stated, the Moray device picks up these surgings or oscillations of energy coming and returning to the universe. It is tuned to oscillate in harmony (sympathetically) with the oscillations of the universe just as musical instruments can be made to vibrate together. Every oscillation, whether large or small, is completed during the same interval of time, the heartbeats of life. The oscillations of the universe are governed by the same eyelet of time and are completed during the same interval of time. As Moray stated years ago, these waves of energy have a regular beat note of time, coming and going like the waves of the sea. They are in a very definite mathematical order of time, coming to the earth from every direction. They are stronger in the day time than at night, but always coming with a regular beat note that might be referred to as the Father of Time; the Sire of Gravitation.

This energy has a definite elastic rigidity and density, which is subject to displacement and strains. When the strain is removed, this medium will spring back to its old position and beyond, surging back and forth as the waves of the sea. It will continue to oscillate until the original pressure is used up. If the internal impedance is too great, there will be no oscillations. It will merely slide back in a dead beat to its unrestrained state. By cutting down the resistance to the minimum and by synchronous resonance (sympathy) of the device with that of the universe, recovery will be quicker and quicker. Finally inertia will assert itself and lengthen the time of final recovery by carrying the recoil beyond the natural oscillation. Thus, the vibrations are prolonged by oscillation. When the recovery is distinctly oscillatory, resonance sets in. The oscillations will go on forever because they come from the universe. These electric oscillations are not simple ones, but surges with a definite beat note.

One will ask, how can you get steady energy from such surging? Since there is a great amount of energy at such a terrific potential could not a steady flow of water be obtained from the surging of the sea?

The operation of the condensers need not be repeated here as they have been fully explained in the enclosed account.

It is not claimed that all of Moray's theory is proven. But it is claimed that the device works. The results are certain. In the absence of better explanations, Moray's theories are as good as any. Moray explained his theory to a well-known and noted American scientist, who said, "You go into your theory that goes back to the law of gravitation".



In this day and age, anything is possible. What was done with radiant energy has been called "radical". Nevertheless, of the great number of learned men who have seen and heard of Moray's work, not one has been able to disprove his claims, theories or discoveries. Some of these men are amongst America's foremost in science. They have spent from five hours to many days on the theory and claims and made test experiments. Hence, these further explanations of the Moray theory, on which he has spent his time from boyhood.

Fully realizing that whatever the difficulties in discovering new truths, there are still greater obstacles in getting them recognized. As Mark Twain once said, "It takes many years to get a new idea fixed in the human mind". One should not be long surprised at the attacks of some or at the exasperation of a certain number of worthy people. Not surprising is the silence of a greater number of the scholars who have heard of these experiments. It is hard for the average human mind to rid itself of inherited ideas, which so completely and unconsciously control our line of thought. Franklin, Faraday, Cavendish and others were unable to always express themselves so that their peers understood their inner meaning. They gave to the World their ideas in a form unintelligible to others of their day. Yet their ideas have since become known facts.

The theory described here is not new in the main, nor is it contrary to ideas that science has accepted today. It is however original with Moray in application. When Moray first advanced them years ago they were "killed" by those who heard of them before they got very far. Be that as it may, Moray has studied "radiant energy" and found a means of using it. Heat, light, power and energy are not things in themselves. They are sensations, or effects produced by this "cosmic power", directly or indirectly.

**"ASTRONOMY" by Robert H. Baker, P.H. D. Professor of Astronomy, University of Illinois**

**Page 303:**

Another problem relates to the apparent lavish expenditure of this radiation. Of all the energy that pours forth from the sun, the planets and their satellites intercept less than one part in 200 million. The remainder spreads through interstellar space with little chance, so far as we know, of being recovered. The suggestion that the sun shines only in the direction of material that can intercept it may appeal from the point of view of economy, but appears to have little else to recommend it. It would seem that Nature is squandering its resources of energy so prodigally that it must end in bankruptcy. But we doubtless have at present, an imperfect account of the situation.

**"FOUNDATIONS OF THE UNIVERSE" by M. Luckiesh, D. SS. Director of Lighting Research Laboratory, General Electric Company printed in 1925**

**Page 5:**

In the far-off stellar crucibles, we see the same laws being obeyed as in our laboratories. Tracing down, to the almost infinitesimal constituents of the extremely minute atom, we find that apparently it does not exist at all. It is not even as the realistic matter that we have supposed it to be. There at its very foundation, it seems to consist of electric charges that probably simulate the motions of celestial bodies. It is becoming more and more certain that the apparent complexity of Nature is due to our lack of knowledge. As the picture unfolds, it promises a marvelous simplicity.

### **Pages 41-43:**

The great success of the atomistic principle relating to the kinetic theory of matter, is one of the wonders of the modern scientific age. As expected, it has found other applications equally fascinating and promising. It is now being pressed further into the service of explaining the structure of matter.

### **Maxwell's Theory**

When Maxwell (1873) propounded the electromagnetic theory of light (radiation), his achievement was epochal. The exact manner in which the radiant energy traversed space was not known. The next epochal event was the founding by Planck (1900) of the quantum theory. Here we have the atomistic principle applied to energy instead of being confined to the material of the universe as it had been. In other words, in the quantum theory, we have the atomistic idea applied to physical processes. We now have the atom of matter, the atom (electron) of electricity and the atom (quantum) of action (a product of energy and time). Planck assumed the emission of radiation (from the sun, a lamp filament, etc.), to occur discontinuously. He conceived elements of energy of equal magnitude; analogous to the equality of electrons, or atoms of a given element. Radiant energy is emitted at various wavelengths or frequencies that must be taken into account in the laws of radiation. Now, the physicist uses quanta as commonly as he does electrons and atoms and molecules. Bodies are built of molecules, the molecules of atoms, and the atoms of electrons (and protons). Here we see the atomistic principle applied to "material" (matter) and then to electricity (what shall we call it)? Finally, a physical process, the radiation emitted by the electrons, is divided into quanta. With such pictures of the universe being constructed, we may cease to be surprised at anything, but our interest and admiration will grow.

One of the most marvelous relationships that have ever been revealed in the entire science of physics is that between light and electricity. Knowing how to view the structure of atoms, this relationship is not quite so surprising. Half a century ago, there was a total absence of knowledge, pertaining to the existence of electrons in atoms of matter. So, the sudden revelation, that light (and radiation in general) is an electrical phenomenon, was very startling and revolutionary. Even today those persons, who are unfamiliar with fundamental physics, find it difficult to believe that energy traveling from yonder star to the eyes, is electromagnetic in nature. But that has been amply proved. It is the atoms in those distant stellar crucibles that possess moving electrons that are emitting electromagnetic waves of many wavelengths or frequencies. Here on earth, we have many "receiving stations" that are tuned to certain ranges of wavelengths.

### **"RADIANT ENERGY" by Edgar Lucien Larkin (1903)**

#### **Pages 17-18:**

Radiant here means proceeding from a center in straight lines in every direction. Energy is internal and inherent.

Professor Barker, "Physics", **page 4**, states, "Energy is defined as a condition of matter in which any definite portion may effect changes in any other definite portion". This was written in 1892 and discoveries since confirm it. Energy then, is a state of matter. Or rather, is it the result of a particular state in which matter may be when any observed phase of energy appears?

These two notions, matter and energy, or, possibly one, is the sum total of all that has been found during three centuries of incessant research. This search has been in that portion of the universe visible in a forty-inch telescope, armed with the most powerful spectroscope ever made.



*ether*

It is the belief of the writer that all this space is saturated with inconceivably minute corpuscles. J. J. Thomson recently discovered these. These are doubtless either electricity in its ultimate refinement, or very closely allied to it, or its immediate carriers. The smallest particle of hydrogen has long been thought to be the smallest mass of any known particle of matter. But the corpuscles detected by Thomson have only one-thousandth the mass of the hydrogen atom. The earth and sun, all suns and dark bodies in space, all granular matter, moves through the primordial cosmic mass of electrical corpuscles as would a wire screen through water. The wide spaces in diamond, glass, steel, flint, or anything else, allow these "bodies smaller than atoms", as Thomson calls them, to pass through.

### **Larkin's Theory on the Transmission of Energy**

From the definition of energy, it is the potential of the universe. When matter is in a phase allowing it to be active, it affects other quantities of matter at a distance. The method of transfer is known to be by means of wave motion. Each impulse moves from the emitting to the receiving mass on a rigorously straight line. One continuous set of oscillations in this straight line is called a ray. Each negative or Thomsonian corpuscle makes a double vibration to and fro like a pendulum straight across the direction of the ray – i.e., at right angles to it. The corpuscle moves over and returns to the original position it had before the excursion. The corpuscles are negative and can be drawn out of their original straight path by the action of magnetism. So, the entire wave motion of the universe is electromagnetic. This is what Maxwell prophesied forty years ago. Thomson fulfilled the prophecy.

After one corpuscle makes an oscillation across the direction of the ray and returns, the next does likewise and the next and so on. After the first corpuscle makes a swing, another distant from it 186,000 miles in the same straight line, will also make a vibration at the end of the first second of time.

**"ATOMS AND RAYS" by Sir Oliver Lodge, Fellow of the Royal Society of Science and holder of five or six Doctors degrees from colleges, with honors from a score more. He has held offices of President in a dozen or more Scientific Societies. Printed in 1924**

The term "light" strictly speaking, means that kind of ethereal radiation which is able to affect the eye. But it is common knowledge that there are many other wavelengths of radiation besides those that effects the eye. It is not clearly known why the eye is sensitive to some kinds of ethereal radiation and not to others. That, no doubt, is a question for physicists and physiologists in collaboration. But the eyes of animals, insects and man, all appear to be sensitive to a limited range of ethereal radiation, which is therefore called light. Some kinds of radiation can affect a photographic plate. Other kinds can stimulate the chemical actions going on in the leaves of plants and thereby supply the energy needed for vegetable growth. Another kind, a rather deeper harmony as it were, supplies everything on earth with warmth and by evaporating water contributes to most of the phenomena of weather. Other kinds, again, are omitted when individual electrons, traveling at a high speed in a vacuum, encounter the obstruction of a target. These kinds of invisible radiation are called x-rays. And, at the opposite end of the scale, great antennas emit another kind of radiation. These are the Hertzian waves employed in radio.

If describing these kinds of radiation as different, we are not speaking quite accurately. They differ only as treble notes differ from bass notes. They differ in rapidity or rate, or vibration or wavelength. They do not differ in any other particular essential. The longest waves are the telegraphic ones, which may be a mile long. Much, much shorter are the x-rays, whose wavelength is actually smaller than atoms, and only expressible in billionths of an inch. This whole range of waves, travel at precisely the same speed. This is the only speed at which the ether is able to transmit energy. They are all of the same electromagnetic character. They are all subject to the same optical laws of interference, of reflection and polarization, which have long been studied in departments of physics.



## **Moray qualifies these statements by saying that there are speeds greater than the speed of light**

Whatever an electric charge is, or is not, it certainly is a focus of energy. Imagine an ether vortex, containing the known mass of the electron and circulating with the velocity of light. The energy of this vortex would be equal to that of the electric field in the space surrounding the electron. This coincidence, if it were a coincidence, can hardly fail to have some meaning. Some thinkers are beginning to view the whole material universe as being built up of ether in various states of self contained or intrinsic motion. These adjectives are intended to discriminate between rotary motion, like that of a top or a whirlpool and ordinary locomotion, or whiffing from place to place. Locomotion has not been attributed to the ether, which is the most stationary thing we know. It is perhaps the only stationary thing that exists, but it may be full of what is sometimes called "stationary motion". This is a paradoxical term, appropriate to the condition of a sleeping top.

Those who hold this view of the universe are strengthened in their position by Einstein's expression of energy in general. It is well known that all ordinary energy, such as the motion of railway trains, or croquet balls, etc, is merely relative to the earth, or to some other piece of matter. There is nothing absolute about it. But Einstein gives an expression for what could be called absolute energy, in which the only relevant velocity is that of light. All the phenomena of Nature, at any rate, inorganic. Nature may be due to this great ethereal velocity. It must appear in a form that enables it to appear to our animal derived senses. For the spinning motion itself is impalpable and beyond the ken of our instruments. It can be detected only when it partially exhibits itself as transmitted waves in the form of radiation.

All the light that we experience can be resolved into vibrations or tremors in the ether. That is how we first knew about the ether. But all electric and magnetic phenomena and therefore, all chemical activity are likewise known to be modes of manifestation of the ether of space. The complete manner and meaning of which have still to be worked out.

So the question arises, What is matter? Is that too a manifestation of some peculiar properties in the ether? We know now that matter is built up of protons and electrons. But analyzing these into their fundamentals, we find far more than a hint that they are but special modifications in the all-pervading ether. They are essentially resolvable into ethereal energy of a specific kind. Hence, we are beginning to think that matter itself is a form of energy.

Energy is one thing in the physical universe that directly appeals to us. We apprehend it under a great variety of forms. And it is becoming provable that what we call matter is one of those forms. Most of the known forms of energy are convertible one into another. The energy of motion turns into heat, as does the energy of electric currents, unless it is converted into the energy of chemical separation or electric charge. Conversion from one form to another, without loss, is the natural-sign of energy. The proof that matter is a form of energy will not be clinched until it can be demonstrated that matter too is convertible into other forms of energy.

Such a process has not yet been performed in our laboratories, or has it? Though it is believed to be occurring in the giant stars. The interior of stars is at an altogether exceptional temperature and pressure. This constitutes a laboratory where results can be beyond the scope of our present manipulation. In the light from those stars we see some small residual outcomes of this production of energy at the expense of matter. In their motions, we probably see the same thing. That, which we ordinarily recognize as the locomotive energy of bodies, seems now to be overflow or surplus of the violent constitutional energy within. This energy, at present seems inaccessible to us, but is possessed in enormous amount by the very constitution of the atoms of matter. Fortunately, a few of those atoms have given us the hint. They have spontaneously emitted their energy. We call it radioactivity. It is only



the heavy atoms of fission material and other substances at that end of the series, which still retain the property of spontaneous disintegration. The other more familiar atoms seem to have lost that power, and settled down into apparent stability and quiescence. These atoms show no obvious sign of possessing any such power. But to the eye of science, it is there.

The combination of atoms into molecules and the interaction of molecules generally have long been known to give rise to various forms of energy. Witness ordinary combustion and the power of explosives. **Simple atoms like those of hydrogen, can be packed together so as to form the more complex atoms of higher elements. This process will liberate vast stores of energy, much greater than could be obtained from ordinary kinds of chemical combination.** It is highly unlikely that this will go on spontaneously or uncontrollably or dangerously, under such conditions, as we are familiar with on earth. They may be violent enough under the conditions in the interior of stars, including perhaps our sun. But here, on earth, they are traceable, guided and controllable. They will not run rampant and do damage, except by reason of bad or malevolent arrangements and then only on a relative small scale.

How soon energy of this kind may become commercial, no one can say with certainty. The practical way is by using energy from the cosmos; i.e., not by so-called fission material.

### **Another Testimonial**

TO WHOM IT MAY CONCERN,

This is to certify that on the evening of March 16, 1929, along with Dr. Wilkinson, of Cedar City, I witnessed a demonstration at the laboratory of T. Henry Moray, Salt Lake City, Utah.

Dr. Moray claims to have invented an apparatus that will produce electrical energy without the use of a prime mover. This apparatus was demonstrated on this occasion.

#### **1. Description of the Apparatus**

The apparatus uses an antenna specially balanced or an aerial capacitor and a special ground wire. These were connected to the terminals of a switch. Two wooden boxes were placed on a table. On one of these boxes was a high-frequency transformer. In the other box were two sets of condensers, ten large ones in one set and ten small ones in the other set. There were two composition cylinders, each about 1-1/8 inches in diameter and four inches long. Each of these cylinders weighed about three or four ounces. In addition, there was another box approximately hemispherical in shape, about two inches in diameter and weighing about two ounces. There were also coils of wires and other equipment. These pieces of apparatus were connected by a number of wires.

Two of these wires were led out to the switch. One was attached to the blade of the switch and the other its' jaw. When the switch was closed, the antenna, lead-in, apparatus in the boxes and ground wire were all in series.

The other wires leading out of the box were connected to six 100-watt lamps connected in multiple during part of the demonstration. A flat iron was connected during part of the demonstration, as well.

## 2. Demonstration

During the demonstration the apparatus was connected in series as above described, except that a small switch connected in series with the coil was left open.

Dr. Moray energized and synchronized the device in three or four minutes. The lamps were lighted and remained bright as long as the switch was left closed, which was about 60 minutes. He then connected an electric flat iron. In a short time, the iron was hot. When the "ground wire" was disconnected and then the lead-in was disconnected, the lights went out.

## 3. Objections people have made

- I. That there is a hidden wire from the electric lighting current that obtains the power.
- II. That the power is obtained from batteries.

## 4. Tests

Before and after the demonstration I closed the big switch that connects or shorts the antenna and ground. I also made other tests. If the antenna or lead-in were connected to the lighting circuit this would have produced a short circuit. I further tested the device by closing and opening the switch several times to see if any sparks appeared. But there were no sparks. I placed my wet finger between the blade and the jaws of the switch and could not feel any electricity. I touched my hand to both sides of the switch and the wall to check for ground but could not feel anything. We turned the table over and examined it carefully for hidden wires but found none. With the apparatus all connected and operating the lights, the contacts with the switch were moved but did not produce arcing. This indicates that the circuit was dead.

While the demonstration was being conducted and the lamps were receiving energy through the apparatus, the main switch, that controls the lights in the building, was opened. All lights on the house circuit went out but the lights on the Radiant Energy circuit were not altered. They were neither brighter nor dimmer at that time. Thus the lights could not have received their power from that source.

The condensers were thoroughly tested. The terminals were shorted, the positive to the negative. If they had been batteries they would have showed a spark. But no sign of spark appeared. I connected them to the electric terminals then tested them. After being charged, the large condensers gave a vigorous discharge, showing a brilliant strong arc and a loud sound. They showed a sudden discharge as condensers are supposed to do and batteries never do.

The small condensers were less vigorous in discharging. They displayed the same snappy discharge of a condenser and not how a battery discharges. These tests proved positively that condensers and not batteries were in the cases. Besides no batteries of such size, could produce such power. The boxes were completely emptied thus leaving no possible place for batteries to be stored. Besides the boxes were not large enough in order to hide batteries.

During the time that the lights were burning the connections with the big switch were moved along the switch and vigorous arcing occurred. Thus, proving that electrical energy was passing through this apparatus.



## 5. Conclusions

The electric lamps received energy from some source. During the demonstration, which lasted for more than an hour, the lights were brilliant at all times, just as bright at the end as at the beginning of the demonstration.

The lights were of a different color, brighter and whiter than those on the house circuit were. The electric energy that lighted the lamps and heated the flat iron was not received from the house circuit.

One is therefore forced to the conclusion that the electric energy was received from some other source. As difficult as it is to understand, with our present knowledge, the only conclusion that can be drawn from the demonstration is that the energy was received by and through the apparatus as claimed by Dr. Moray.

T. J. YATES, KE N.E.

### **This next letter is from Murray O. Hayes Ph.D.**

To all whom it may concern,

It is now more than two years since I first became acquainted with Dr. T. H. Moray and the work he is carrying on. In that time he has demonstrated inventive ability of an exceptional order.

Perhaps the most wonderful of his inventions is a device whereby he is able to draw electric power from the Cosmos. This energy is not derived by induction from power lines, as has been suggested by some, nor is it derived from radio stations. This has been demonstrated by taking the apparatus more than 50 miles from the nearest power line and over a hundred miles from the nearest radio station. At this location it operated just as well as anywhere else. This device was subjected to an endurance test in which it was operated continuously for a week. During this test a 100-watt lamp was lighted simultaneously along with the heating of a 575-watt standard Hot Point flat iron, making a total of 675-watts. It is very evident that no batteries could sustain such a current drain as this. Besides the current is high frequency.

He has also invented a very sensitive sound detector whereby it is possible to hear conversations carried on in an ordinary tone of voice, at a distance of several blocks.

He has also worked out numerous radio designs that eliminate many of the parts now considered necessary for good reception. Yet, there was no apparent diminution in quality or volume. In fact, there was a notable elimination of interference from static when some of these designs were used.

He has devised a means for measuring with some degree of accuracy the energy evolved during mental activity. His device shows variable deflections of a sensitive galvanometer needle that appeared to be related to the rigor of mental activity.

There are a great many other equally remarkable things that he has done. For example, reducing old rubber from truck tires to the state of a viscous fluid. This fluid is readily vulcanized without the addition of a smoke sheet as is necessary with other processes. He also created a high frequency therapeutic device and numerous other devices, which show great ingenuity.

Murray O. Hayes Ph.D.

**This letter was addressed to Mr. Lovesy and is from Murray O. Hayes, Ph.D.**

Dear Mr. Lovesy,

As promised during our recent discussion, I am writing about my acquaintance with the construction and operating principles of the Moray device for utilizing cosmic energy.

You are already aware that I have seen many demonstrations of what this mechanism will do. Also, I have seen the parts of which it is built. Recently Dr. Moray has shown to me the wiring diagram of the device. I can find no inconsistencies in it, not anything that does not appear to be logical and sound. While this device appears to be very complicated, when looking at the machine, it is in reality very simple in essence. It is based on reorganized laws of electricity, when all is explained. There are many features which appear to be incidental, but they are in reality of basic importance.

He has also shown to me and explained the detector that his device uses. In this he has applied a fundamental principle of electric circuits which, I believe, would not have been noticed unless pointed out by him. This detector also has numerous features which appear incidental but are the heart of the matter and of first importance.

In my own home he connected his detector into a crystal set for receiving radio in place of the crystal. The reception was better than with the Erla crystal, though the antenna was merely one of the bell type. He also took a lump of lead treated according to a process of his own. He used it in place of the crystal and got wonderful reception of radio signals. They were loud enough, in fact, to operate an old fashion horn speaker of the type put out by RCA around or about 1923.

I was recently present when an electrical engineer representing the Russian government was given a demonstration of the energy machine. He at first said that the amplification of radio waves accounted for the output energy. However, it would be a real achievement to amplify such waves sufficiently to light six one hundred-watt lights at one time. This is in addition to heating a flat iron of the standard five hundred seventy-five-watt type. When this engineer saw the inside of the device, he admitted that it could not have been radio waves. He remarked many times, "It is very interesting".

This machine has been operated in my presence so many times, under so many different conditions of weather and of Season that I am positively convinced that it is what its' inventor claims it to be. I also believe that its' commercial adaptation is feasible. I believe that Dr. Moray has explained everything to me without reservation. I am sure that this is a revolutionary and epoch making invention.

Sincerely yours,

Dr. Murray O. Hayes



## Patent Correspondence

Dear Henry,

For your information, I wish to report on the matter of your radiant energy machine since coming here.

We arrived here Friday, July 10. On Monday, July 13, I spent the whole day in the search room of the Patent Office. I examined every patent issued by the U. S. on devices for the reception of radiant energy. Most of them were so obviously dissimilar to your invention that they did not consume much time. Not one is there which shows, on reading, even the remotest resemblance to your radiant energy machine. Not one mentions such an idea.

Neither is there any patent that suggests anything like your oscillator tubes. I feel perfectly safe in saying that there is not one chance in a hundred thousand that the examiner will find any disclosures that will restrict your claims. I have always felt certain that you would obtain broad protection on your radiant energy invention. But now I know it for certain.

You may use this letter in any way that you see fit.

Very truly yours,

Murray O. Hayes

### **Thomas J. Yates, E.E., M.E, wrote this notarized letter**

TO WHOM IT MAY CONCERN,

I witnessed a demonstration of the apparatus invented by Dr. T. H. Moray by which he produces electrical energy. A report of that visit has already been made.

I now have, about two years later, witnessed a second demonstration of the same device; some changes in the apparatus were noted. A great improvement was made in the performance. The condensers, coils and other parts, noted at the previous test, were now in one small box about 10 x 10 x 30 inches. A safer and better means of starting the device has been devised. Once the apparatus is put in operation, it will continue to charge itself.

The lamp rack that formerly held six 100-watt lamps has been replaced. The new rack is larger and holds thirty-two 50-watt lamps, three 100-watt lamps and a receptacle to receive an extension plug and cord. On the other end of this cord a 575-watt electric iron was connected. During this test, all of the electric lamps were lighted at one time. Their light was whiter and more brilliant than other lights in the room, which were supplied from the house circuit. When the lights were on bright, the electric iron was plugged in. There was no noticeable blinking or sudden diminution of the lights as in the usual house lighting systems when an electrical iron is turned on. The lights were as bright as before the iron was plugged in. The iron heated quite rapidly. In about 2½ minutes it was hot enough to be used for ironing.

I made a thorough and careful examination of the entire system to see if electricity could have been introduced from some another source. I inspected every part of the system, all wires were checked; the switch was removed and examined. Leads from the switch to the box containing the condensers and coils were checked. The box itself was lifted and examined. The leads from the box to the lamp rack

were inspected. The lamp rack was lifted and examined, as was the ground wire from the switch to the water pipe on which it was grounded. Not an inch of space was overlooked where there might be any metal that would carry the power. I am prepared to say that no such connection existed from which power could be had from any other system.

A crystal radio set was connected to the lead-in wire from the antenna on one side and to the ground wire on the other. Perfect reception was had. If there had been power from other sources on the antenna or lead-in wire radio reception would not have been possible. Instead a loud humming sound would be produced; this was demonstrated by connecting the radio set to the house lighting system.

When Moray's system was working, the lights were burning bright. The terminal attached to the antenna was disconnected. A vigorous arcing occurred and the sparks jumped over an air gap as long as eighteen inches. This would indicate that the power was high voltage. The nature of the sparks indicated a high frequency current.

I do not understand the principle by which Dr. Moray's device produces the electric energy. The condensers and the coils of wire are common. The cylinders called "oscillators" and the small conical shell called the "detector" are the only things not commonly known, but the system works. It produces electric power in abundance and does all that Dr. Moray claims for it.

I do not own any stock or interest in Moray's work. My only purpose in issuing this statement is in the interest of the advancement of science. I consider this development a great advance in the science of producing electrical energy.

Very truly yours,

In witness to the above I hereunto sign my name.

(Signed) Thomas J. Yates, E.E., M.E.

STATE OF UTAH COUNTY OF SALT LAKE

Thomas J. Yates, being first duly sworn, deposes and says that he has read the foregoing statement and acknowledges that he wrote and signed the same as above set up.

(SEAL)

Thomas J. Yates

Subscribed and sworn to before me this 18th day of December 1930.

My Commission expires R. J. Chapman May 7, 1934 Notary Public

Residing at Salt Lake City, Utah.



**This letter was addressed to Moray from W. H. Lovesy**

Dear Henry,

I have handed you the original letter from Murray O. Hayes, in which he described being shown and having explained to him the wiring diagram of your R.E. device. Also the fundamentals of the detector were explained to him. In that letter he stated plainly these fundamentals would not have been noticed unless pointed out by you. At the same time, he had become familiar with all of the details of the construction of your device for utilizing cosmic energy. He added that you had applied only fundamental principles of electric circuits.

There is attached a second letter containing details of Mr. Hayes educational record.

I made the memorandums on the face of these two original documents at the time I was consulting with Murray O. Hayes in my office. At the time he definitely advised me of being shown every detail of your invention. Mr. Hayes stated that he could make one of the machines himself from the information that had been given him.

Murray O. Hayes made similar statements to me several times. I have made repeated requests that he would make these declarations. Namely that he had been shown every detail of the invention. Perhaps these repeated requests gave him the impression that I had a doubt about the invention.

Personally, I have never had a doubt. But I thought that only you held the real detailed secrets of the invention. I had a conference in New York with Dr. Harvey Fletcher and Dr. Carl Eyring at the Bell laboratories. I agreed with them to ask you to give the details of your invention to Murray O. Hayes. The purpose was to determine if he could duplicate your machine. In every instance his answer was emphatic and to the effect that he could do so.

Yours truly, W. H. Lovesy

**This letter is from Geo. R. Pyper**

To Whom It May Concern,

I have worked in electricity all my life. I was with the Utah Power and Light Company for thirteen years and worked in all departments including sub stations. I have been with the Kearns Corporation for over seventeen years. I have been in charge of all the electrical work for the Tribune and Telegram Publishing Company and in the Kearns and Tribune Buildings.

In last December I witnessed a demonstration at Dr. Moray's laboratory of his electrical marvel box. He let me see inside this box. There was a H. F. transformer, some of his cold tubes and some condensers. Dr. Moray connected this box to a special balanced aerial and ground wire from outside the building. Two of us held a counter poise antenna attached to glass insulators in the room. When he connected the box to this counter poise antenna, I saw the same results as with the external aerial.

During this demonstration and while the lamp and appliances were operating, I shorted the aerial and ground wires. There was no spark; it just turned off the power from the box. I then took hold of both of these wires and felt nothing. They were cold.

He then took a larger box, about 18 x 30 x 15 inches and connected it to the outside aerial and ground wire. From this box he lighted about fifty 100-watt, 120-volt lamps, ran a small motor specially wound at great speed, an original electric iron and a 500-watt glow heater.

Dr. Moray then disconnected the appliances and lamps and attached two long wires to the box. We pulled the main line, Utah Power and Light Company service switch for his building. We attached the wire from the box to the building side of the switch. He lighted his building and heated iron heaters. In fact, he did everything the Utah Power and Light Company service would do except run motors that I understand have to be specially wound.

Standard globes were used. They seemed to give a softer whiter light that was more like daylight.

I am satisfied from my experiences with electricity that there was no fake of any kind such as concealed batteries or wires. Everything was in the open so I could see every operation. I did not see the inside of the larger box.

It was a very remarkable demonstration and one that I will always remember.

Geo. R. Pyper

#### Key Clues Given by T. H. Moray

##### **Radiant Energy by T. H. Moray, second edition 1931**

As far as atomic energy is concerned for heat, light and power, it is and always will be nothing more or less than an expensive, dangerous, glorified steam plant or an equally dangerous thermoelectric device. The process involves breaking into the lines of force of the radiation field that surrounds the reactor to capture energy. Such a plant, no matter how efficient, never is the complete answer to the World's energy problems. Costs and weight will always be a great problem. Any nuclear fuel, even the most "super nuclear pile reactor", or what have you, is, and always will be, just another way to operate an energy plant from any heat, light and power viewpoint. p. 1

The facts involved are the same in both the radio receiving set and this device. The nature of the mechanism, however, in one differs greatly from the other. The radio receiving set receives transmitted energy waves out of the air and transposes them into sound waves. The R.E. device receives oscillations from the universe, and transposes them into electricity. p. 13

Cosmic rays are constantly creating radioactive carbon. The fusion of small atoms together to make larger ones gives off more energy than so-called "splitting" of the larger uranium or plutonium atoms. The uranium energy release ratio is only 1 to 1000 – that is only 1/1000 of the heavy atoms are changed in the uranium "atom splitting" process of the atomic pile. p. 60



## "Radiant Energy" by T. H. Moray, third edition 1945

This account will endeavor to give a brief explanation of the Moray Radiant Energy device whereby it is possible to utilize the vast store of energy of the universe without a prime mover through the splitting (natural decay) of the atom by the action of the universe not man-made splitting of the atom.

The Moray device is not perpetual motion, but it utilizes energy that already exists and transforms it into useful forms. p. 7

This energy, or as Dr. Moray explains it, these oscillations of energy, are picked up by the device through the oscillators, or neutron bombardment. p. 8

As in the reception of radio waves and **radio active waves**, so in this the circuit is tuned by the right arrangements of inductance and capacities and of a special "valve" of our own construction, to prevent the return of the power to the outer circuit and force it to go through the power application circuit. ) - X

In reference to electrons, neutrons, protons and ions, it is my theory, in using these terms, that they are the energy of the universe. p. 17

My device oscillates because of the oscillations of the universe caused by the disintegration of matter. p. 18

## "The Sea of Energy In Which The Earth Floats" by T. H. Moray, fourth Edition 1960

Nikola Tesla was not referring to so-called atomic energy or nuclear energy but to the energy that is continually bombarding the earth from outer space. Call it cosmic, or what one will. p. 1

Enough energy is coming to the earth to light 1,193,600 one hundred-watt lamps for every human being alive today. No fuel of any kind will be taken. Energy can be "picked-up" directly by great ocean liners, railroads, airplanes, automobiles or any form of transportation. In addition, heat, light and power can be available for use in all kinds of buildings. p. 1

(Electrons are spontaneously being emitted from the nuclei found in Nature.) Every new discovery on the subject bears out the claim that all "space" is filled with energy containing millions of amperes at very high voltages. p. 89  
→ ZPR to either to electron to etc. ) - X

Pellets were made of a mixture of the **Moray lead** that withstands heat over 1800°F. Using pure germanium mixed with bismuth, iron sulfide, triboluminescent zinc and certain other impurities including the **Moray fission material**, he obtained a substance that had wonderful properties as a detector or valve for radio signals. p. 128

With this germanium combination alloy used as a detector, it was found that radios would operate without batteries or any source of power other than that obtained from the **radio transmitting station**. p. 128

To make this special R.E. energy valve, he used a lump of lead (Moray lead). It was treated according to the process that he has discovered and got wonderful reception on a radio. p. 129

**This is from a speech that was given by T. H. Moray on Jan. 23, 1962 at the Valley State College Northridge, California**

It is now estimated, because of present advances in dielectrics that a 100-lb. unit can be made to deliver 300KW. That is gross weight, not net weight. p. 11

**"The Sea of Energy In Which The Earth Floats" by T. H. Moray, fifth Edition 1978**

The Eyring Research Institute, before Henry Moray died, was working on "Direct Energy Conversion Systems". This involves using radioactive material in conjunction with the quartz junction. p. 89

In 1942, shortly after World War II began for the United States, Henry Moray attempted to rebuild a radiant energy device. He used the remaining bit of what was known as the "Swedish Stone". This material limited the amount of power that his device could draw. Consequently, in the larger unit, he developed a second detector that forced him into extensive research involving nuclear materials and radioactive reactions. He became deeply involved in the study of (synthetic radioactivity) as described by Gustave LeBon in his book, "The Evolution of Matter". p. 186

\* - (Others may discover Direct Energy Conversion Systems using synthetic radioactive materials.) Bell laboratories have made millions of dollars from semiconductors, though no credit has been given to Henry Moray. p. 190

11 April 1990

**Arthur Glenn Foster  
Principal Engineer**

There are some interesting side details. "We" (a group of us in government and industry, loosely coupled) were pursuing "Project X". We had a contract to process some of the Moray "valve", fine-ground, "Swedish Stone" into pressed "detector" pellets. The pellet material was doped with a tiny amount of unpurified radium reduced from U238 yellow cake.

The pellets were subjected to a huge number of millibars of pressure by a tetrahedral press used for manufacturing artificial diamonds. This technique was developed and patented by Dr. Tracy Hall after he left GE. When a certain critical pressure was reached "something" in the material "flashed". The electric pulse produced was so violent that it burned out the 2000-amp carbon-die heater power supply, blew the main breakers in the building and blew the power line transformer on the outside power pole!

*Interesting how it was attracted to tubes of high reactance + inductance*



## My Radiant Energy Research

Whenever radiation from a radioactive substance ionizes atoms, electrons are emitted. The electrons almost immediately recombine with the positively charged atoms that expelled them in the first place. Charge equilibrium occurs at the exact moment of recombination, along with electromagnetic oscillation. A by-product of this phenomenon is called **ionic oscillation**. Radioactive particles will again separate the newly recombined atom. In fact, any electrically neutral atom will lose electrons when exposed to radioactive matter. The atom that is left behind becomes a positive ion. This process of ionization and recombination is a continuous cycle as long as the atom is exposed to a source of ionizing radiation.

Whenever a fairly large amount of oppositely charged ions coexist within a small volume of space, the accumulative radiation from recombination can add up to an intense, constant wide-band frequency. This phenomenon prevails around many stars in our own galaxy and is concentrated around nebulas and star clusters. Indeed, this is a very old source of energy. All we have to do is attach our machines to this "wheelwork of nature".

By studying radioactive reactions the final secret to harnessing the very wheelwork of nature is revealed to us. (Ionic recombination) of the decay products of radioactive isotopes will produce intense surges of electromagnetic energy. More often the wavelengths created are in the infrared (thermal) range. However, the wavelengths generated can also manifest within the radio frequency range or even far into the **gamma** end of the electromagnetic spectrum. They can even be made to manifest as free electrons. What does the decay of radioactive matter teach us about the true nature of energy?

hydrogen  
→  
helium

In United States Patent 2,728,867, it is stated that each gram of nuclear fuel that is undergoing fission gives off around twenty watts of power. In comparison, one gram of **polonium** will generate about one hundred and forty watts of power. This is **seven times** more energy than what is available from a conventional nuclear reactor! However, being as attractive this appears, polonium emits radiation that is deadly to life. It is the most toxic substance known to us. It is not the answer to our energy needs.

\* — (Under the right conditions, ordinary matter can be made to generate intense surges of radiant energy that can be heard on a radio receiver as static noise. Build a device that can efficiently capture this energy and convert it into useful electrical currents and you will have yourself a powerful source of electrical power. This device will be powered by artificially disintegrating matter as described by Gustave Le Bon in his book "The Evolution of Matter" and in his book "The Evolution of Forces".)

Energy and matter are two distinct entities of the same manifestation. Matter represents a stable condensed form of energy. Heat, light, electricity, etc., are uncondensed vibrations of matter oscillating at differing rates. "Cosmic Energy" is the term that Le Bon used to define matter and energy as being one and the same manifestation. He theorized that when stable matter is disintegrated it is transformed into energy that we recognize as heat, light, electricity, radioactivity, etc.

\* — There are semiconductors that will generate intense surges of electron oscillations that become powerful sources of radiant energy. A simple **ion-valve**, or call it what you will, can be used to generate and convert this form of radiant energy into useful electromagnetic oscillations. A tuned transformer can be used to directly convert these oscillations into to a practical voltage and amperage. This unique valve is shown in **Figure 4**. Before it can function it must be connected to a suitable voltage source. The circuit in **Figure 5** demonstrates the full working concept. Other embodiments are also possible. The proof of concept circuit reveals how radiant energy can be generated and converted into useful electrical currents. Many additional stages can be added for more power. Many other circuit and component configurations can also be used but the fundamental conversion principle remains the same. The circuit and components shown should give you a very clear idea of how the technology works. The actual mechanics and electronics of building and validating a radiant energy prototype are relatively simple. Contrary to what some people might think, dangerous levels of radioactivity are never used in my devices.

If you want to get involved in building prototypes, you must first confront some serious issues before beginning. I will try to enumerate a few pitfalls and make the descriptions as clear as I can. This will fortunately and blessedly push some of you into action, but for others it will be viewed as an impossible challenge.

### **What are the most important assets for beginning my research?**

1. Dedication
2. Motivation
3. Passion
4. Do instead of just theorizing.

### **What is the second most important thing?**

The lone wolf researcher will need a lot of skills if their project is to be successful. Among the most valuable skills are those involving electronic technologies. Plus, some familiarities with machine shop practice and materials. A good sense of organization is important. Being able to stand-back and observe the big picture, along with a lot of plain, good old common sense, are necessary skills to have. The "hands-on-imperative" must be at the very core of your efforts.

### **What if I have few tools and skills but have the dedication?**

Then you will need to have some cash, the green stuff. You will have to buy the skills, knowledge and time of others. You can farm out electronic and machining chores but it will be expensive. The more that you can do for yourself the better off it will be for you in the long run.

A fully equipped, skilled, advanced amateur radiant energy experimenter might slip by for about \$500.00 for everything. If you have only a few tools hanging around then a proof of concept prototype might cost you around \$1,500.00 because of the extra tools and supplies that you will have to purchase. Later you can build a more powerful prototype to replace the proof of concept design. Your basic working design will not have to be replaced. You can add more components as your research progresses. Simple dedication goes a long way. Watching, paying attention to details and doing it right the first time are all very important. With this borne in mind, you could complete a powerful prototype for around \$10,000.00 that could provide power for the average home. However, it is not now my intention to instruct you on how to build a home power unit. This book was written so that you may understand the technology.



## **Are there any dangers involved?**

Yes, of course there are! There are a number of ways to wind up in an early grave! Most of the lethal dangers can be avoided with **skills**. Read first and do second. Reference books and a solid, broad-based scientific library are your true assets. Access to the Internet would also be very helpful. Know the danger zones in the various disciplines that you are going to come across in your research endeavors.

The radiant energy circuitry is connected to an antenna and ground. A lightning strike could fry the device and burn down your house to boot. I take no responsibility for this. You build these circuits at your own risk. Take the time to install lightning protection on the antenna and ground leads. It could save you a lot of grief in the long run.

Some specific dangers...

1. Crushed and mangled hands of the unwary or metal splinters in the eyes or skin.
2. There are burn and eye damage hazards.
3. Imploding glass bell jars and ion-valves can scatter glass splinters at high velocity into your face and body. Always use glass enclosures that can withstand the vacuum that is being applied.

## **Do you have what it takes to go the distance?**

If you have what it takes and you have a burning passion for this research then you are probably ready to begin the journey. This is not a place for a wimpy mentality. If you become frustrated or fail in your experiments, have the courage and good grace to realize how this came about. Make the effort to find out where you made your mistakes.

More than likely, you are going into this research learning from books that have been written to hide certain facts from you. Do not expect results over night. Learn all that you can by careful observation, educate yourself, search out the truth first and let Nature be your guide.

There are political powers in this World that would not like to see us succeed in getting radiant energy power implemented. They know quite well that this energy source will liberate the global community. This mode of power generates not only power, but it will also generate hope for our decaying World.

## **Fundamental Radiant Energy Device**

First of all, let me say, there is no fringe science involved with radiant energy power generation. This is a very old source of energy being extracted and harnessed in a unique way. What I have discovered is practically a limitless source of energy. Radiant energy has existed since the beginning of time. What I hold claim to is an improved method to generate and to convert radiant energy, kinetically active ions, cosmic energy, call it what you will, into useful electrical power. Think of the radiant energy power generator as a type of energy detonator that liberates great quantities of energy with only a small exciting spark. No laws of physics are being violated. No new laws are being implied. They are being expanded. The concept is not that much different than how a lighted matchstick is able to start a bonfire.

## Ion-valve Oscillator

"Standard" scientific principles are not being violated. There is no fringe science involved. This is a very old source of energy being harnessed in a unique way through my discoveries. The discoveries that I have made have for the most part have gone unnoticed. What I claim is a method to generate a source of radiant energy that is converted into useful electrical current.

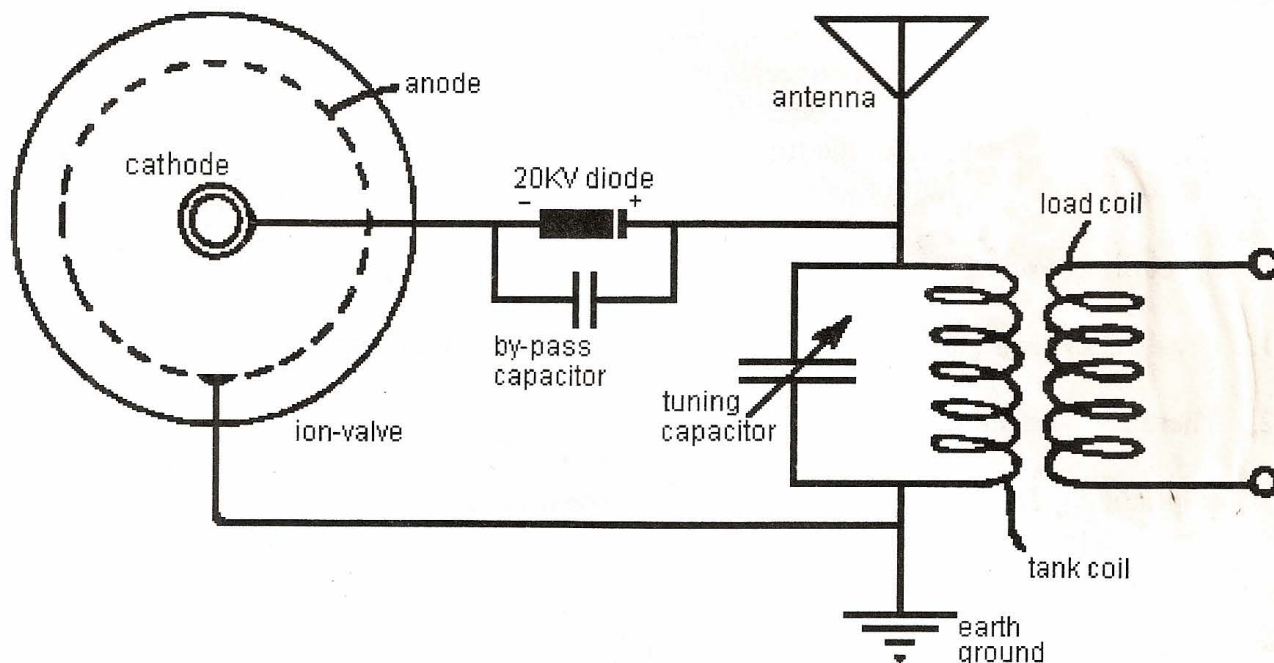

**Basic Radiant Energy Receiver - Figure 3**

The excess energy that is generated from my ion-valves comes from the transformation of matter into radiant electricity. It does not come from the splitting of atoms. To obtain high wattage from a spontaneously radioactive substance would require unsafe amounts of radioactive material.

The ion-valve utilizes catalytic reactions that take place when positively charged ions from the cylinder are accelerated against one another around a negatively charged corona wire. The cylinder consists of a catalyst – platinum, palladium, nickel, etc... from which positive atomic ions are emitted. The reactants stream through the chamber parallel to the length of the wire and attain the polarity of the **negative molecular ions** by the high electric field close to the wire. As the negative molecular ions are accelerated at right angles to the wire in the direction of the electric field toward the **positively charged catalyst** cylinder, they are met with an avalanche of onrushing ions from the cylinder that meet with them. Introducing radon gas will increase the emission from the wire and therefore its efficiency. The radon gas is attracted to the negatively charged cathode wire where it decays and leaves a deposit of electron emitting lead-210. If the valve is properly constructed only a minute amount of radon gas is necessary.

My ion-valve oscillators now function on the principle of the magnetron. They are cold cathode tubes. I use a small amount of Naturally Occurring Radioactive Material (N.O.R.M.) in the tubes. This material is used so that they function without the need to heating the cathodes. Further research might make it possible to completely eliminate the need for the N.O.R.M. altogether.



## Ion-valve Converter

### Technology Explained

The ion-valve converter (ion-valve) shown here has an axial negatively charged tungsten cathode wire that extends the length its cylinder charged and is capable of emitting secondary electrons. The anode cylinder is positively charged and is made from a semiconductive material that readily captures electrons.

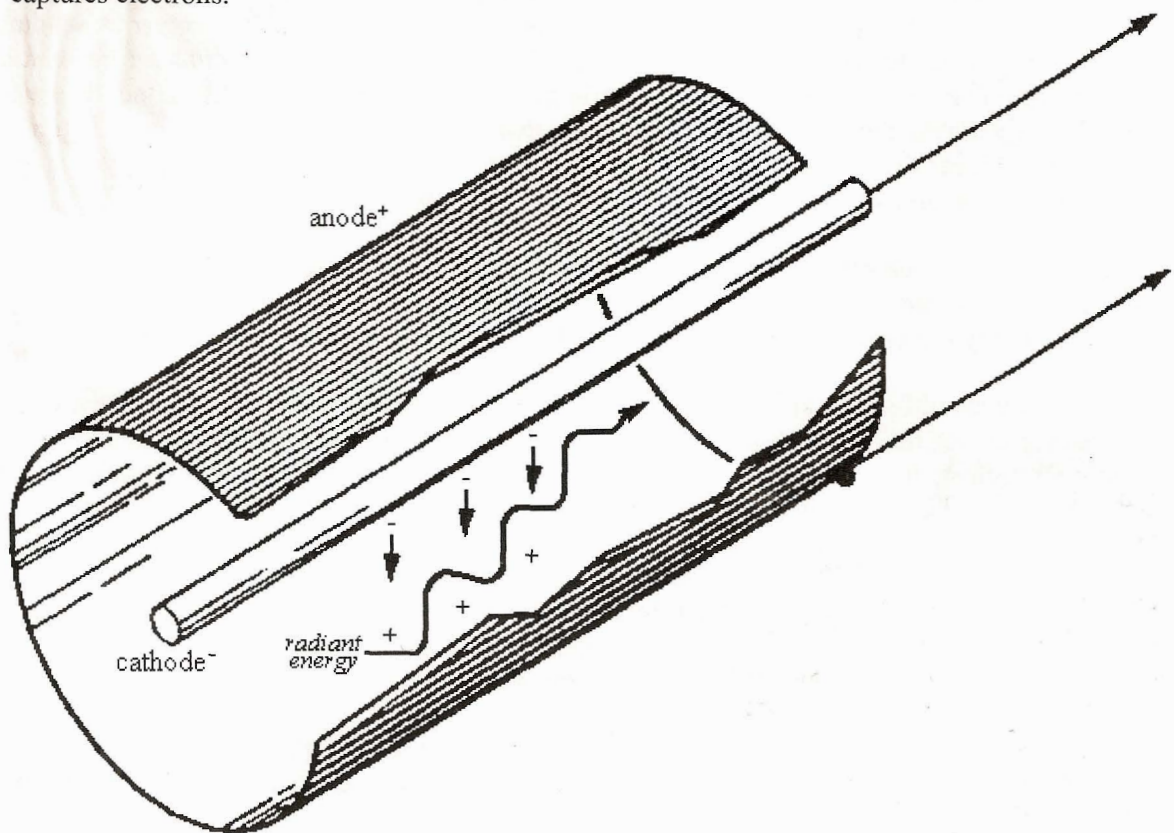

**Ion Valve - Figure 4**

Within a few milliseconds the accumulated negative ions are attracted to the positively charged onrushing ions. When the negative and positive charges collide they neutralize each other generating a surge of radiant energy. Ultraviolet photons cause atoms in the cathode to disintegrate and emit secondary electrons.

There appears to be a common thread shared between several alternative energy devices. It is the pre-glow discharge. The report on the **Hans Coler** device released by the British Government indicates that there is excess energy released when electrical contacts are opened and closed. The **Lester Hendershot** device utilized a buzzer circuit that opened and closed its electrical contacts. In the **Alfred Hubbard** coil pre-glow discharge flowed through electrical contacts, a distributor



cap and radium soaked spark plug. The **Joseph Newman** motor used a sparking commutator. **Thomas Moray** invented a glowing, cold cathode discharge tube that was the heart of his radiant energy generator. **Hermann Plauson** was granted U.S. Patent No. 1,540,998 that used spark gaps to collect and convert atmospheric energy. **Frank Wyatt Prentice** was granted Canadian Patent No. 253,765 that detailed his invention, which lighted 50 sixty-watt carbon lamps with an input of only 500 watts. His invention utilized a spark gap driven high frequency tuned resonant system. **Chancy Britten** used pre-glow ion valves constructed with a central wire that was surround by a coil of wire which is described in his US Patent No. 1,826,727. Britten's valve was said to have lit up his home in the 1930's according to a local newspaper article of that time period. **Alexander Chernetski** experimented with what appears to have been a type of ion-valve that was filled with hydrogen gas. It is said that he got up to five times more energy out of his device than what he put into it. **Edwin Gray** was granted U.S. Patent No. 3,890,548 for his efficient spark gap driven capacitive-discharge motor. He improved on this patent by replacing the spark gap with a (pre-glow discharge switching tube.) His U.S. Patents No. 4,595,975 and No. 4,661,747 describes this tube in detail. Gray's patents claim to conserve battery power by sending unused energy back to the supply batteries. Gray thought that counter-electromotive force was solely responsible for recharging the batteries in his system. When in fact it was the generated radiant energy during the pre-glow discharge cycle that was the main recharging factor. **Paulo N. Correa** and **Alexander N. Correa** also obtained patents to their pre-glow discharge system that demonstrated a small over-unity effect.

hydrogen &  
helium\* -  
ether.  
doorways  
\*

Moray and the Correas were the only inventors that appear to have been aware that excess energy was generated because of the pre-glow discharge effect between their electrodes. However, it appears that they did not know the exact physics that generated this excess energy.

\* - The ion-valve should not to be confused with a current rectifier. The ion-valve provides a stable potential difference that prevents energy from flowing back to the high voltage feed. It allows AC to flow through it. It is an "energy dam" for the lack of a better description. The valve has a charge blocking effect. This is why Moray stated that the valves are not rectifiers in the sense that they operate as radio valves in changing AC or HF to DC. The ion-valve has an actual valve action in stopping the "flow" of potential energy in one direction. Diodes used to change AC or radio frequencies to DC are current rectifiers. The ion-valve is a **charge separator**. Its function may be thought of as an oscillatory action similar to the waves of the sea, without rectification, preventing energy from returning back to the energy source. \* The Sea of Energy, fifth edition, p. 209.

radiant  
eng. tube

According to the "sea electron model" metals are bonded to each other through electron sharing. In the embodiment in **Figure 4** the negative charge on the wire negatively ionizes any gas that contacts it. These ions rush towards the positively charged cylinder. When an ion that carries an excess electron hits head-on with a positively charged metal atom the electron combines with atoms of the metal. The electron that is absorbed by the metal atom passes along its kinetic energy. This causes the metal atom to oscillate generating a photon burst. When ultraviolet photons are generated and impinge upon atoms some of these atoms are dissociated and excess electrons are released. The **sea electron model** helps to explain this effect. The model suggests that metal atoms be bathed in a sea of valence electrons. If this model is taken one step further it can be seen that when metallic atoms are dissociated from each other (excess electrons are released in the form of raw electrical energy.) This occurs because the electrons no longer take part in the inter-atomic binding force that existed before the disintegration took place. It becomes clear that impinging photons break the binding force between the inter-atomic structure. The freed electrons will add amperage to the output circuit to which it is connected. Henceforth, the equation  $I \times E = P$  holds true in this system. Where, "I" represents the electrons (amperage), "E" electromotive force (ionic voltage), and "P" the power generated.

\* -



# Modern Radiant Energy Conversion System

## Obtaining Electrical Energy from the Transformation of Cosmic Energy

Matter is cosmic energy in a condensed state according to Le Bon and Moray. What this means is that matter can be excited and caused to rapidly disintegrate transforming itself into electricity. It has been found that certain semiconductors can be utilized under sealed ideal conditions to achieve optimum results.

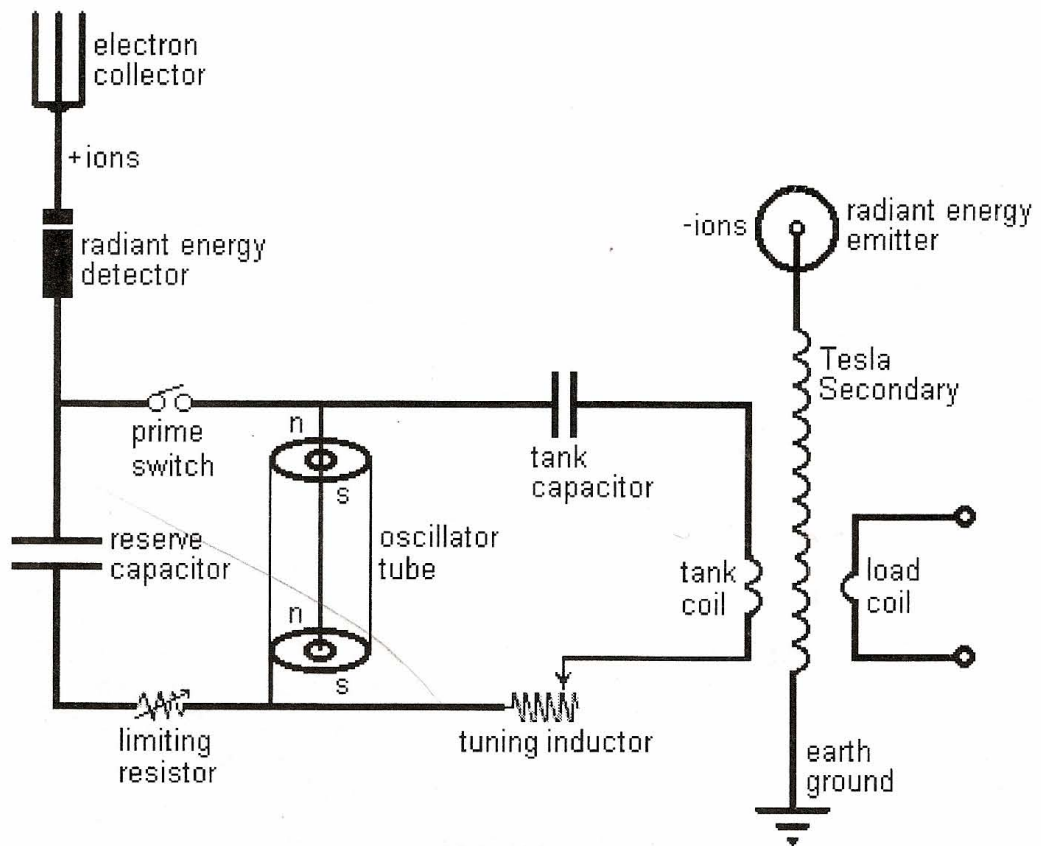

**Proof of Concept - Figure 5**

The proof of concept shown in **Figure 5** above obtains energy from the disintegration of matter bringing the circuit to life. The heart of this power device is its radiant energy emitter tube that contains proprietary semiconductors. It generates a high-density supply of electrons. These electrons charge the surrounding air. The antenna (electron collector) then attracts the charged air, which consists of negatively charged air molecules, and grabs their reserve of electrons. The captured electrons are directed to flow through a charge separator (radiant energy detector). These electrons are stored in a reserve capacitor. The oscillator tube converts the static charge that is held in the reserve capacitor into high frequency oscillations. The tuning inductor synchronizes the tank circuit with the generated radio frequency oscillations for optimum energy absorption. A Tesla step-up high voltage coil is inductively coupled to the tank circuit. This excites the

semiconductor in the radiant energy emitter into a state of artificially induced disintegration of its inter-atomic structure. Excess electrons are generated. A resonant step-down coil is also inductively coupled to the tank coil to provide power to the external load.

According to the law of conservation, when we give to a material body a determined quantity of energy, this energy might be transformed, but the body will never give back a quantity in excess of what it received. This principle is considered to be too self-evident to be disputed. It makes sense that matter can only give up energy that is given to it and is unable to create excess energy. Without violating the law matter can be excited into giving up its stored inter-atomic energy. This can be accomplished by exposing matter to ultraviolet photons of the correct wavelength. The atoms of matter become uncondensed and are transformed into radiant energy.

Radiant Energy in the ultraviolet region acts like a spark on a mass of explosive material. This is to say that the radiant energy emitted when condensed energy (matter) becomes uncondensed (energy) will be far superior to the force that invoked it in the first place. The energy that is condensed in certain elements of matter can be immense. The result is that an enormous amount of energy is released with only a slight loss of matter. Gustave Le Bon demonstrated that the action of solar light on bodies produced electric particles similar to those of uranium. He showed that it caused all bodies to disintegrate to different degrees. His examinations ended up being narrowed down to the ultra-violet region of the electromagnetic spectrum.

### **Obtaining Radon for Cold Cathodes**

My radiant energy conversion system uses unique ion-valve oscillators. These tubes do not require a source of radon gas but if we are going to generate useful wattage in a small, compact unit, then a minute amount of this gas should be used as a catalyst.

On the pages that follow I will give full details that will show you how to isolate a natural substance that will evolve radon gas for experimental purposes. With this information you will be able obtain this gas very cheaply. You will have to go out and find the radioactive rocks yourself. Be forewarned that the United States Government has notified mineral dealers that they are no longer allowed to obtain radioactive rocks from the mines and sell them to the public.

You will need to do some research to find radioactive ore. Your state map department should have a booklet on mineral and mine locations. There are also mineral books that will give you a general idea of what these rocks look like. There are well over 100 different radioactive mineral types throughout the World. Go to a good bookstore and pick up a mineral book that has color photographs so that you can visually identify your samples. After looking over your mineral book you can then go out and locate a radioactive rock source. It is much easier if you are prospecting for fluorescent radioactive rocks. Fluorescent minerals can be spotted at night by exposing them to a source of ultraviolet light. My extraction process is systematically outlined on the following page. Your goal is to extract only the radioactive oxides leaving behind the non-radioactive junk to discard. If you follow my instructions carefully the natural percentages of the radioisotopes will not be altered and the substance produced should be exempt from nuclear regulations.

Otto Hahn had originally discovered that a radium preparation in a state of fine subdivision would evolve large amounts of radon gas. His U.S. Patent No. 1,655,184 – Jan. 3, 1928 describes the principle effect in detail. The value of my process may not be apparent at first glance. My preparation offers an improvement over this prior art because it eliminates the need to isolate radium. Where an inexpensive source of radon gas is required the full value of my preparation will be appreciated.



**Step #1.** Half-fill a one-gallon pickle jar with crushed radioactive rocks. Next cover the rock material with muriatic acid (28% hydrochloric acid). You can get this acid from your hardware store. This is used to clean bricks. Your rock material should be fully emerged in this acid solution. Let this solution stand for about twenty-four hours before proceeding to the next step.

**Step #2.** Pre-screen your extract into a second cleaned one-gallon pickle jar. Use pre-cut plastic door screen obtained from your local hardware store.

**Step #3.** Next, filter your pre-screened solution into another cleaned one-gallon pickle jar using a coffee filter. The color of this extract solution should be canary yellow to dark green. The color will depend on your ore source.

**Step #4.** You will now need to prepare a barium chloride ( $\text{BaCl}_2$ ) solution that precipitates uranium from your extract. You will need to purchase the  $\text{BaCl}_2$  from a chemical supplier. The precipitating solution is prepared by adding  $\text{BaCl}_2$  crystals to a clean one-gallon pickle jar that is  $\frac{1}{4}$  filled with distilled water. You will add the crystals until they no longer dissolve. More crystals will dissolve if the water is slightly heated. Slowly stir the solution with a plastic stirrer and add the crystals until you obtain a super saturated solution. Be sure to wear safety glasses and rubber gloves when working with chemicals. Another safety rule is to always add chemicals to a solution and never add water to the chemical. This is to avoid possible violent reactions.  $\text{BaCl}_2$  and  $\text{H}_2\text{O}$  do not violently react but it is wise to wear rubber gloves and safety glasses to avoid skin and eye contact respectively. Also, work in a well-ventilated area because  $\text{BaCl}_2$  is hazardous to breathe.

**Step #5.** You will now slowly add the super saturated  $\text{BaCl}_2$  solution that you prepared in step #4 to the extracted solution from steps #1 through #3. In a few moments you will begin to see clear crystals forming in the solution. You will keep on adding the agent until the crystals stop forming. Two distinctive layers of crystals will form. My hypothesis is that the lighter top layer is a mixture of U234 and U235. The heavier bottom layer is U238. The uranium in the solution forms a double salt with the barium. Therefore both layers are double uranium/barium salts. Further testing by an outside laboratory will need to be done to confirm this theory. \*See pages 57-58.

**Step #6.** Next, you will need to drain off the clear liquid from the top of the crystals. You can save the clear liquid for future extracts. Do not attempt to separate the lighter crystals from the heavier ones. This would violate nuclear regulations by altering the isotope percentages.

**Step #7.** Finally, you will need to find yourself a cast iron frying pan. Here you will put the crystals into this pan. Now, expose the crystals to intense heat using a propane plumber's torch obtained from your local hardware store. Be sure to perform this step in a well-ventilated area because the crystals bubble and release toxic barium fumes. Do not breathe these fumes! Expose the crystals to the torch flame until there is no more reaction. What you want to end up with is a grayish-brown powdery substance. Let the pan cool before removing the substance. The grayish-brown powdery substance that you have just isolated is only slightly radioactive at this point. It begins to show stronger activity within a few days. It will build up to full activity in about twenty-eight days. The value of my extraction process is that it economically converts low-grade ore into a finely divided high-grade ore that evolves radon gas. The material that we end up with from this process can be found in the natural World. This means that the material is exempt from nuclear regulation. My preparation consists of U235 in a finely divided state that is widely dispersed throughout extremely subdivided U238 and thorium oxides. This gives the material the ability to freely liberate radon gas.



## Going Beyond the Curies

The residues of the uranium extraction process were discarded as valueless for years until the discovery of radium by Madame Curie. In her analysis of the radioactive constituents of pitchblende, the ore was first fused with sodium carbonate and then dissolved in hydrochloric acid. The metals of the lead group in the pitchblende, such as lead, copper, and bismuth, were removed by precipitation with hydrogen sulfide. The remaining metals, such as iron and lead were also removed by precipitation with suitable agents. A radioactive element combined with bismuth was also isolated. It was called "Polonium" in honor of Madame Curie's native country.

A mixture of barium and radium chlorides remained in solution. After the removal of the metals of the first two groups, the last and most tedious process of extraction was to obtain the radium chloride as free as possible from the barium chloride.

The Curie process of extraction of radium chloride from barium chloride is called "fractional crystallization". This method depended upon the fact that radium chloride is less soluble in water than the barium chloride. Therefore, if a mixture of these two chlorides is dissolved in water or alcohol, the first crystals to form are richer in radium than those that remain in the solution. These first crystals are the richest in radium.

The first crystals were collected, again dissolved, allowed to re-crystallize and collected as before. The cycle was repeated many times until the crystals became practically free from the barium. When the purest radium chloride was obtained its intensity was about 1,500,000 times than uranium.<sup>(3)</sup>

3) Excerpts taken from "RADIUM: and other Radio-active Elements" by L. A. Levy and H. G. Willis; Percival Marshall & Co., from pages 17 - 21. This book is undated, but its bookplate suggests it was new in 1908.

Madame Curie's process was very time consuming and the barium was never completely removed. Only small amounts of radium could be obtained, making it a very rare substance. To this day there are very small inventories of this substance, making the cost prohibitive for research and practical applications. The Curie process of extraction, being so long and so difficult, has made radium research impractical to this day. Besides, it is the effects of the radon gas that the radium holds that produces the effects we seek.

### The Perreault Process

The method that I use to extract uranium, thorium, and radium from their parent ores is the opposite of the Curie Process. Instead of evaporating the barium solution, super saturation is used to form double salts. My process takes only a few minutes whereas the Curie process takes a few months. This makes possible a new era of research that requires radon gas. My method also opens a doorway to producing uranium and thorium more economically, without the normally associated hazardous and wasteful by-products.

Due to the expense associated with radium salt no one had thought to expose it to high temperatures. It is the heat treatment that yields the extremely finely divided pure oxide. We now can study the true nature of what has been dubbed "radium". I have made great strides in my research with the discovery of my disclosed preparation.



## Naturally Occurring Radioisotopes

The natural world contains many storehouses of energy as can be seen by the chart below. Here is a listing of all of the naturally occurring radioisotopes that nature has to offer...

Isotope	Decay Mode	Percent found in Nature
C <sup>14</sup>	$\beta$	?
K <sup>40</sup>	$\beta$ EC $\gamma$	0.0118%
V <sup>50</sup>	$\beta$ EC $\gamma$	0.25%
Rb <sup>87</sup>	$\beta$	27.85%
In <sup>115</sup>	$\beta^+$ $\gamma$ $\beta\beta^-$	95.72%
Cd <sup>113</sup>	$\beta$	12.26%
Te <sup>123</sup>	$\gamma$ EC	0.87%
Te <sup>130</sup>	$\beta^-$ $\beta^-$	34.48%
La <sup>138</sup>	EC $\beta$ $\gamma$	0.089%
Nd <sup>144</sup>	$\alpha$	23.85%
Sm <sup>147</sup>	$\alpha$	14.97%
Sm <sup>148</sup>	$\alpha$	11.24%
Sm <sup>149</sup>	$\alpha$	13.8%
Gd <sup>152</sup>	$\alpha$	0.20%
Dy <sup>156</sup>	$\alpha$	0.052%
Hf <sup>174</sup>	$\alpha$	0.18%
Lu <sup>176</sup>	$\beta$ $\gamma$	2.59%
Ta <sup>180</sup>	EC $\beta^+$	0.012%
Re <sup>187</sup>	$\beta$	62.93%
Pt <sup>190</sup>	$\alpha$	0.0127%
Pt <sup>192</sup>	$\alpha$	0.78%
Rn <sup>219</sup>	$\alpha$	?
Th <sup>232</sup>	$\alpha$ $\gamma$ $f$	100%
U <sup>234</sup>	$\alpha$ $\gamma$ $f$	0.0055%
U <sup>235</sup>	$\alpha$ $\gamma$ $f$	0.72%
U <sup>238</sup>	$\alpha$ $\gamma$ $f$	99.27%

**Natural Radioisotope Chart - Figure 6**

Any of the above listed beta particle emitters' can be used to add electrons (amperage) to the voltage that excites my ion-valve. The most practical isotope listed appears to be In<sup>115</sup> because of its abundance and its present cost. These isotopes were created through billions of years of **cosmic ray** bombardment of ordinary matter. Their matrixes are unbalanced. The correct trigger will cause these isotopes to seek their original balanced state. Enormous amounts of electrical energy can be obtained from the transformation of stored cosmic energy. These isotopes contain a very old energy reserve that can be released in a unique way through the use of my discoveries.

## Precautions

My radiant energy power generating system does not involve splitting atoms. Therefore, no toxic radioisotopes are created like there are using conventional nuclear processes. Like with many other potentially dangerous chemicals, there is not an overwhelming degree of safety hazard using some degree of respect.

Treat the outlined steps and procedures with thoughtful consideration. The hazards of radiation in the amount that you will be involved with is far less dangerous than the dozens of toxic, caustic, and corrosive chemicals that are handled in a typical lab setting. Use caution to prevent unwarranted contamination upon yourself or the environment. The following points should be kept in mind.

- Work in a private area that is free from public access.
- Cover the surface of your work counter with a sheet of plastic. Then cover it again with a smaller piece, edges folded upward, where the dissolving procedure is carried out. This will contain any acid spills.
- Wear protective clothing such as lab coat and acid proof gloves that will not be harmed by hydrochloric acid.
- Work in a well-ventilated area.
- Have an audible radiation detector nearby to constantly monitor the background or to check for possible contamination spots.
- Do not allow the powdery radon emissive substance to become airborne contamination that could be inhaled.
- Decontaminate if necessary with toweling and acetone.
- Discard solid contaminated wastes in a sturdy plastic bag or container and personally dispose of it in a designated landfill dump.

## Warning

Radon gas that is attracted and concentrated on the negatively charged wire in the ion-valve will decay to lead-210 within a few days. In a few years the lead-210 decays to **polonium**. Polonium is very dangerous to handle in even milligram or microgram amounts. Damage arises from the complete absorption of the energy of the alpha particle into living tissue. Once an ion-valve tube has been energized do not unseal it. Like anything else it poses little risk if it is respected. It must be noted that if you were to get polonium into your blood stream through an open wound on your body it could be fatal. With this in mind properly dispose of old tubes.

As an illustration of the enormous activity deposit of polonium, Marckwald stated that a precipitate of only 1/100 of a milligram on a copper plate, 4-square-centimeters in area, illuminated a zinc sulfide screen so brightly that an audience of several hundred people could see.

**Please, study all aspects of my research before attempting your own experiments. I take no responsibility for any form of damage or injury caused by misuse of the information contained within the pages of this book. You are experimenting at your own risk. The information herein is sold for educational purposes only!**



## Treatise on Matter & Energy

*Matter and Energy are one and the same...*

### Three Primary Particles

Atomic theory does not predict every reaction created by the various states of matter and of energy. There are principles in Nature yet to be revealed. Something has been missing from the over-all atomic picture of matter and energy. There are three primary particles that bring the elements into existence. Just as the colors red, green and blue combine to give us the entire rainbow, the same holds true of the three primary particles, protons, neutrons and electrons. The combination of these three basic primary particles is what gives physical mass to an element and to its' unique characteristics. Its physical size, its mass, gives it a signature. With this signature comes its "elemental" name.

If a given element is not in a kinetic state then it is said to be at complete rest. It is cold. The external forces acting upon it determine a particle's energy level. When struck by another particle, it becomes kinetic. It is this kinetic activity that we call heat. This heat or kinetic energy level may be raised by particles which impinge upon it that have higher kinetic energy levels. The "heat" of an element may be lowered by other elements that impinge upon it that have lower kinetic energy levels. This will cause the element to lose some of its heat. It is therefore "cooled". However, the elements fundamental make up is not changed. An element may acquire the kinetic energy level of visible light and still retain its fundamental properties. Its' signature is not changed.

### Gamma Radiation

An atom that absorbs or expels neutron particles will ring like a bell. It emits gamma energy. Whenever an atom gains or loses neutron energy it generates gamma energy. Gamma energy is a disturbance phenomenon.

The only difference between natural and artificial gamma energy levels is their origins. Natural gamma rays are emitted from the nucleus of a radioisotope. Artificial gamma energy is generated outside of the atom. Gamma rays and x-rays are often called photons. They have no mass and no charge and may be considered to be energy disturbances in space.

### Wavelength

The kinetic energy level of a radiating element determines its wavelength of energy. A low kinetic level is represented by a long wavelength on the chart. A high kinetic level represents a short wavelength on the chart. The "speed of light" is therefore a relative term. Energy is contingent upon the matter that it impinges upon.

The x-rays begin at about the middle of the ultraviolet portion of the spectrum. These are called soft x-rays. Those that extend into the lower portion of the gamma range are called hard x-rays. Beyond this range, they are called cosmic rays. These energy disturbances are called "photons". They are not particles. They are disturbances caused by the kinetic states of particles in motion. This energy spectrum proceeds in order of decreasing wavelength; sound, thermal, visible light, ultraviolet, gamma, and the cosmic rays.

### Pair Production

If a photon has sufficient energy, its energy may be absorbed by atoms. The photon interacts with electrons. This gives rise to a process called "pair production", in which the energy of the photon is absorbed by the atom.

### Photo Disintegration by Gamma Energy

Atoms can absorb high-energy x-ray photons, those with energies above 10MeV (Million electron Volts). Here, the electrons within atoms are raised to an excited state and instantaneously emit high-energy gamma radiation. This makes the atom receptive to nuclear transformation. This process is called "photo-disintegration".

### 1.02MeV Energy Barrier

It has been calculated that when one electron pairs with another, 0.51MeV of photon energy results. Since two electrons are involved in a pair production event, a photon must have at least 1.02MeV of energy to separate them. A photon with less than 1.02MeV will not produce a pair production event. Any energy in excess of 1.02MeV is distributed equally between the two electrons.

### Electrical Energy – Electron Cloud

An atom is negatively ionized when it gains electrons. The atom is positively ionized when it loses electrons. How can it be then that a (helium particle) expelled from radioactive decay is charged to (millions of volts positive?) This observation can mean only one thing, that the electron shells are really an abstract thought for mathematical calculations, when concretely the atom is a mixture of electrons, neutrons and protons. The electron cloud consists of thousands of actual electrons. It must be noted that an electron is approximately 1,830 times smaller than the mass of a proton. The scientific community has ignored this little fact. As an example it will take around 1,830 electrons to equal the mass of one proton in the hydrogen atom. So, it is said that there is one proton and one electron in the hydrogen atom. What really should be said is that there is one proton and approximately 1,830 electrons. However, it is much easier to state that there is one electron in the hydrogen atom for simplicity. The mathematical electron shell theory need not be modified to fit this reality. It is convenient to use the square root of the actual number of electrons that surround each nucleus, for day to day chemical formulations.

*Helium + hydrogen  
doorways  
for alpha & ZPR*

X → When electrons or negative ions rush towards a positively charged atom in order to reach equilibrium, it is said that an electric current is generated. This current is created by a particular energy state called "voltage". If a metallic conductor has electrical current flowing in one direction then one end of the conductor has an excess of electrons. The opposite end has a deficit of electrons. All "electric oscillations" are a result of this phenomenon. Battery power, direct current generators, alternating current alternators, radio, microwaves, radar, electronic oscillators,



metallic coils and condensers, electron-tubes, ion-tubes and transistors, magnetrons, klystrons, lasers, masers and molecular transitions; all carry these oscillations.

So then, what is electricity? This question has eluded the most able intellects throughout human history. Could this be because science has ignored the fact that the electron in an atom is actually representing more than one thousand electrons, not just one? As observation shows, two states of energy exist, one "negative" and the other "positive". How could it be that there are two states, identical in their properties, opposite in character, both clinging to matter, both attracting and yet completely neutralizing each other? From this analogy, it is safe to say that electron differences create the effects of electricity.

## **Chemical Cohesion**

Atoms are attracted by virtue of their differing kinetic phase relationships. Matter stays together because of this principle. Atoms are continually expanding and contracting in unison with their kinetic frequencies. Expanding particles are attracted to contracting ones and visa-versa. "Gravitation" might turn out to be a grand display of this phenomenon. Atoms will repel atoms only if they are in the state of coherent kinetic vibration. This occurs when atoms are vibrating in phase with each other. Coherence will raise energy levels. Differing elements will form "compounds" when their fundamental frequencies are in accord with each other. They must ring harmoniously.

## **Ultra Chemistry**

The first law of thermodynamics describes the principle of the conservation of energy. It states that "energy is not created or destroyed; it merely changes form". The fact is that the creation or destruction of energy is a result of matter being broken down or built up. They both go hand in hand.

I strongly believe that the three primary particles were created at the beginning of the universe and that they can not be destroyed. However, the good news is that to serve our needs we can artificially alter the combinations of the protons, neutrons and electrons found in matter.

I will dare to further state that neutrons not only reside in the "nucleus", but they also exist throughout the atom as a homogenous mix with the other primary particles. The most simplistic expression of the **Perreault Atom** involves the bold statement that neutrons reside in balance with the protons and electrons within the atoms. This concept applies throughout the entire Periodic Chart of the Elements.

## **Isotopes**

Three hydrogen elements (isotopes) are known to exist that are chemically similar but have different weights. The three weigh differently due only to neutron content. These are all hydrogen atoms. However, it is the neutron count in the atomic shell that determines what isotope it is.

It is clearly established that triple weight hydrogen (tritium) decays to helium-3. In this particular transformation a charged normal weight hydrogen element (protium) carries an excess electron in its shell. It can react with tritium and emit an electron as a by-product of the reaction. At this moment the electron is emitted at an accelerated rate and is seen as beta energy. This model will not alter the way we view chemistry, however, nuclear transformations should be seen differently.

## Gravitation

Each individual atom is at the center of its own universe and has a unique resonant frequency that is representative of its specific mass. Lithium for example has a greater mass than the hydrogen atom and will vibrate at a lower frequency in comparison. Therefore, we may say that it is caught by the earth's gravitational pull more readily and has more weight. This may help to explain how physical objects are attracted to the earth.

## Stored Nuclear Energy

Have you ever wondered about spontaneous radioactive decay? Is it really a super charged state of matter? If an atom can become ionized by either gaining or by losing electrons then why can there not be a nuclear ionization too? I hypothesize that atoms do become ionized on the nuclear level by gaining or losing neutrons. This may appear incidental but could be at the very heart of an ultra-chemistry. I say that it is highly likely that this very phenomenon is behind natural spontaneous radioactive decay and explains many unanswered questions about nuclear science.

Atoms can gain or expel neutron particles, some to a greater or lesser degree. Thorium can readily be transformed into a fissile isotope of uranium by absorbing neutrons. It is a known fact that thorium stores more energy than uranium, coal, oils and all other fuels combined. This represents a tremendous amount of stored energy. Thorium could be our most economic source of energy. It is almost as abundant as the element lead.

\* — It is only by passing from one state of equilibrium to another that matter can lose or gain energy, consequently emitting radiation. The notion that radioactivity originated in a peculiar chemical process was adopted and defended by Rutherford. "Radioactivity", says he, "is due to a succession of chemical changes". My research seems to indicate that this "succession" is due to neutron transformation.

## Nuclear Transformation

Elements that absorb neutrons and become unstable are called "radioisotopes". When an atom absorbs neutrons it is seen as a "fusion" reaction. When an atom loses neutrons, it is seen as a "fission" reaction. All elements can "transform" into a radioisotope and visa-versa. Radioactive isotopes are unstable and will transform into stable elements. A radioactive isotope will eventually revert back to the original element on its own accord. A radioisotope is a natural storehouse of energy. We need not look any farther for our energy needs. Nature holds an inexhaustible supply.

## Induced Radioactivity

When bismuth is exposed to radium, initially it becomes several hundred times more active than the radium. This is due to emanation that clings to the surface of the bismuth. Emanation is widely known as radon gas that will eventually decay to polonium. It releases more energy than any single natural element that has been discovered.

If beryllium is exposed to radium, neutrons are generated. These neutrons will have penetrating power several times that of the most energetic gamma energies. This activity is due, not to an alteration of the inactive matter itself, (but to an admixture) of a very small quantity of intensely active matter. —\* Does the increased activity occur when matter gains or losses neutrons? Could it be that a neutron is actually an inert monatomic gas? This would certainly explain a few gaps in



accepted atomic theory. Could it be that radioactive matter is simply in an atomically charged state? It is recognized that when an atom gains or loses electrons, it becomes "charged". However, I have taken this one step further by suggesting that matter will also become super charged when it gains or loses neutrons.

### **Strange Nuclear Facts**

Primary neutron particles and gamma energy levels are generated in nuclear transformations. This results in the atom becoming super charged.

A "chain-reaction" in radioactive matter is due to the concentration its excess neutrons that it contains. The greater the concentration of excess neutrons, the more accelerated the decay process becomes.

For example, if beryllium metal is added to radium metal, neutrons are generated. These neutrons can be used to cause secondary nuclear reactions in a fissile material. The beryllium becomes the nuclear trigger.

The energy released by the transformation of beryllium is estimated to be at around 50MeV and that of boron nearly as large. The excess neutrons generated can be used to super charge atoms thus transforming them into radioisotopes.

### **Cold Fusion**

Here is a "cold fusion" reaction to consider. Radon gas (a pure alpha emitter) generated from the decay of radium is deposited onto a beryllium wire. The beryllium in reacting with an excited alpha particle will generate a "cold fusion" reaction without the need for excessive heat, as is the case for "hot fusion". The reaction that results is:  ${}_4\text{Be}^9 + {}_2\text{He}^4 \rightarrow {}_6\text{C}^{12} + {}_0\text{n}^1 = \text{cold fusion}$ . The secondary neutron particles generated can now trigger a chain-reaction in nuclear fuels. Atoms need not become fragmented from the above reaction. Therefore, the reaction is "clean". There are other examples but this formula will give you the general idea.

Alpha fusion is actually a cold fusion reaction. The end result generates neutrons from the production of fusion by alpha particle absorption. A simple equation where mass squared by it's speed equates to temperature. This equation can be applied to a kinetically energetic alpha particle in my model. Simply stated, a fusion reaction occurs when there is a temperature differential between the alpha particle and the target that it impinges upon. It must also be noted that if no new neutrons result from the reaction then the reaction is considered to be a clean nuclear reaction.

The over-all alpha fusion reaction is cold. This is in contrast to reactions that produce excess residual heat. For example, a heat pump will absorb hot particles from the cold air of winter. The average temperature is cold. We can apply this to alpha fusion. The average over-all alpha fusion reaction is cold. You may still consider the reaction to be hot. In fact, it is in every real sense of the word. Even so, the term cold fusion is a non-mathematical one. We can use it to denote the difference between reactions that result from a CERN particle reactor and those that are naturally directed by ultra chemical reactions. As you can see, I do not buy into what the textbooks say about what constitutes a nuclear reaction as compared to a chemical reaction. All reactions are chemical in my point of view. The sited alpha reaction is an ultra extension of chemistry. The textbooks have over complicated the "nuclear reaction" in my assessment and in doing so have fogged the truth in many instances.



## Some Ignored Uranium Facts

1. U235 emits ultraviolet light. \* Galen Winsor, "Nuclear Scare Scam" – lecture
2. U238 expels electrons most readily when exposed to a wavelength of 3000 Angstroms in the ultraviolet spectrum. \* Rentschler, A. I. E. E. 1930, p. 49 & p. 576
3. The UV light wavelength of 254 nanometers is a catalyst to oxidation processes.
4. The 254 nanometer frequency of light kills viruses, molds and other pathogens by rendering their DNA inactive. It therefore disinfects drinking water.
5. The human skin is reddened (erythema) and is most sensitive to the wavelength of 3000 Angstroms (254 nanometer range). \* Hauser and Vahle, *Strahlentherapie*, 1921, p. 13 & p. 41

## The Effects of Radon Gas Excitation

When radon gas is electronically excited it generates a healing energy. This particular type of radiant energy possesses great powers of penetration, exceeding, in fact, the penetrating powers of ordinary x-rays. These rays have been proven to be harmless and may be used, if desired, to produce clear radiographs. They are antiseptic, germicidal, and are good tissue builders possessing wonderful healing powers. They will also effect photographic plates, produce phosphorescence in certain substances, render the surrounding air conductive to electricity and can produce heat in some materials. What this means is that ion-valves that are used in the circuitry to generate electrical power could have the side benefit of improving our health. A patent that utilized excited radon for health benefits was granted to L. Winklemann titled "Radioactive Vacuum Tube" U.S. Patent No. 1,466,777 – Sept. 4, 1923.

Many chemical processes and reactions that do not normally take place, or that proceed with difficulty will occur under the action of excited radon gas. Moray stated that he was able to create rubber without the addition of sulfur by exposing his rubber solutions to the rays for a short period of time. He was also able to produce a metal that would not heat when drilled. Treated metal bearings by his process were used in his high rpm, high frequency motors.

## Liberated Energy

With a slight excitement from a thin beam of invisible radiant energy, or even with no excitement at all, as we observe in spontaneously disintegrating radioactive bodies, such as U235, we can obtain large quantities of energy. Clearly, we did not create this liberated energy, since it already exists in matter, but we release it under the right conditions. This is being done without violating the law of energy conservation. The idea that matter could be transformed into energy was absurd before the acknowledgement of nuclear transformations.

A Nu Science is on the horizon. It involves the means of transforming matter into energy without splitting atoms. This science recognizes several isotopes of matter that spontaneously liberate energy as observed in naturally occurring radioisotopes. It is possible to speed up the natural decay process using a minute excitement as from a ray of ultra-violet light, etc... With a very small quantity of energy we will be able to produce a very large quantity of energy without splitting the atoms. My process speeds up the natural decay process without generating harmful by-product nuclear wastes.



## Alpha Fusion

"Alpha fusion" is an amazing natural process. Here is a comparison of the energy released per atom of uranium that undergoes fission versus alpha fusion, via neutron absorption.

$$\begin{aligned} \text{U235 fission} &= 161,000 \text{ kWh/kg } (2 \times 10^8 \text{ BTU/lb.}) \\ &\text{vs.} \\ \text{Alpha fusion} &= 1.68 \times 10^{11} \text{ kWh/kg } (2.6 \times 10^{14} \text{ BTU/lb.}) \end{aligned}$$

The potential implication of this alpha fusion formula staggers the imagination. There is a lot of room for innovation and creativity. Imagine having a device that could safely provide power for several decades without recharging. Sounds almost like science fiction you say? It is a scientific fact! Plutonium-238 is a non-fissile isotope that decays by **alpha particle** emission with essentially zero associated gamma emissions. This type of plutonium spontaneously produces about one kilowatt of energy for two kilograms of mass. This reaction will release alpha particles that can only travel a short distance before they are stopped. This process decreases slowly over time. After ten years the energy production is about 92 percent of the initial value. Even after 87 years the material produces about half as much energy as when it was first started.

When positively charged helium atoms (alpha particles) collide with the **electron cloud** that envelops another atom the positive charge is eventually canceled by these collisions. This is called "absorption". Atoms ring like a bell when impinged upon by alpha particles. This ringing state generates **x-rays**. The wavelength of this generated x-ray depends on the charge of the alpha particle and what type of atom it hits. If the x-ray generated has an energy level that exceeds 10MeV, atoms absorb it. In this case, the neutrons are raised to an excited state. They may be broken loose from the shells of an element or a neutron may be added to a shell. Gaining or losing neutrons via this process can create radioisotopes. We can efficiently do this by exposing atoms to alpha particles. In the process matter and energy is neither created nor is it destroyed.

Generally, the formation of a chemical compound is accompanied by the release of a definite amount of heat per unit mass of the substance formed. The burning of a fuel is a chemical reaction in which oxygen is consumed. The quantity of heat released when a unit of fuel is burned with oxygen is called the "heat of combustion". For the average coal, this value is from 7,000 to 8,000 calories per gram or 12,000 to 14,000 BTUs per pound.

In contrast, **radioisotopic** transformation is accompanied by the release of enormous energy when compared to conventional oxygen – electron oxidation. However, this does not justify the theory advanced that neutrons occupy the center of atoms. It is my hypothesis that neutrons reside in the orbital shells of elements and not within the nucleus. To envision this atomic structure one only has to look at our own solar system to see this on a grand scale. Isotopic oxidation (neutron oxidation) simply involves the neutrons. However, the energy involved is much greater because the neutrons represent neutral charge and therefore the binding energy of the elemental shells is of a greater magnitude altogether.



When the unstable isotope of an element reverts back to its original stable state energy is released in the transformation. Now, consider what will happen if we tune into the resonant frequency of an unstable isotope like naturally occurring U235. By tuning into its resonant frequency we would make it ring like a bell. Assuming its absorption wavelength is correct, according to the resonant frequency of this element, its instability would increase, its stored reserve of energy would be released. This could be done with any isotope. However, U235 will "self-fission" and under the right conditions, will not require any source of energy other than what it emits. Excess energy is released only after enough neutrons are captured to cause the transformation of the U235 atom. This is called the "break even" point, beyond which excess energy is released to effect a "chain-reaction". Therefore, only a minute amount of energy is required to ring this atom like a bell.

We are not limited to the U235 isotope to use as our fuel source. This element is used in a commercial nuclear reactor because it undergoes self-fission and requires no additional catalyst in order to "burn". The public does not generally know that the U238 in a commercial reactor does not undergo fission. The only reason for its presence is to capture neutrons that transform it into weapons grade Pu239.

U238 will "fission" via fast neutrons generated by the alpha fusion process. However, there is one small hitch to the alpha fusion process. A nuclear fusion fuel material is needed along with the U238 alpha emitter. This material generates the required fast neutrons for this type of fission. All that is needed is the right type of spark to speed up the decay rate. Radium, radiothorium, U235 can be used as the alpha source. Beryllium, boron, or carbon can be used as the fusion catalyst. Any of the elements below periodic number fifteen feasibly could be utilized. However, these three elements sited pack the most wallop. The alpha fusion formula that I have described points the way to a simple and economical atomic process. Virtually no excess neutrons would result that would lead to a toxic waste problem. Fully depleted U238 could be used that does not contain U235. Instead of making nuclear bullets, like the ones used in the Gulf War, we could be using our reserves of depleted uranium as a beneficial fuel source.

Plutonium is not feasible at this time, so plain old, natural, untreated uranium will do the job. One pound of "yellow-cake" ( $U_3O_8$ ) is equivalent to 31 barrels of oil or 10 tons of coal. At the time of this writing yellow cake costs less than \$10.00 per pound.

For political reasons' people, organizations and government agencies have strongly opposed the use of all forms of nuclear energy. These people have made the general population paranoid of any and all radioactive materials. Despite this strong opposition and threats against its development, work continues with the dream of harnessing its transformations safely. The atom makes energy available to us. I have proposed a radical atomic theory to explain the nuclear energy process. Conventional atomic theory has many flaws in my assessment. It does not completely explain the energy created by a nuclear reaction. Does this mean that the nuclear reactor does not completely create energy? No matter what theory you wish to use in explaining atomic power, the fact still remains that energy is transformed.

James Chadwick discovered the neutron in February 1932. Later, further studies were made to discover what effects would be produced by bombarding different materials with this new particle. Researchers for the next several years bombarded every known element with neutrons and recorded hundreds of new radioactive isotopes. My own research in this area has revealed many secrets of the vast reservoirs of energy contained within the atoms.



## Electronically Activated Neutron Source

In the winter of 1996, I applied a 90,000-volt negative charge to a carbon rod. This carbon rod was surrounded with radioactive ore in a closed container. Under these conditions, the radon gas emitted from the ore was attracted and absorbed into the charged rod. This marked the beginning of my research into ion assisted atomic transformations.

The initiator for the first plutonium weapon was composed of polonium coated onto beryllium. The polonium came from the Radium Chemical Company.

"It must be first remarked that helium is a gas which accompanies all radioactive minerals. It was from these bodies that it was first obtained – a catalyst with an interesting effect."

"This derivation from radium is a **special helium** since it appears to possess the property of spontaneously vanishing. Its' only resemblance to ordinary helium seems to consist of the momentary presence of some spectral rays." \* The Sea of Energy by T.H. Moray, 1978 fifth edition, pages 229-230.

The results of my life-long research have opened a doorway that could lead to electronically induced nuclear fusion. I originally named this process "alpha fission" to connote this electronically induced atomic reaction. The term was chosen so as to cause the least adverse social reaction to this discovery, due to the fact that the public has been duped into a state of paranoia by its global governments. Later, this term was changed to alpha fusion, as this is a more accurate term than the original chosen term.

Conventional nuclear reactors generate deadly toxic radioactive wastes as by-products. These reactors are even more deadly than anyone realizes. Fuel rods in the reaction process are extremely hot and are subjected to enormous internal pressures. Untold dangerous amounts of radon gas could leak into our environment if the fuel rods become overheated. We must take a close look at clean nuclear processes before it is too late (if it isn't already).

With the advent of electronically triggered neutrons, a self-sustaining chain reaction can be obtained and may be highly controlled. I find this especially true if **thorium ore** were to be used. Thorium emits **thoron** ( $\text{Rn}^{220}$ ). Owing to its extremely short half-life, thoron by itself can not be used as a source of strong radiation. However, in conjunction with its parent substance radiothorium, it can indeed be used as a strong source of radioactivity.

Thoron has a short half-life of 54.5 seconds. On the other hand Radon-222 has a considerably long half-life of 3.5 days making it a hazard. Thoron is safe and convenient to work with because there are no long-lived products in its disintegration chain. Therefore, there is minimal danger of permanent contamination. The parent substance, radiothorium, may be obtained from thorium solutions in the manner described next.

Radiothorium is generally used as a parent source of thoron. Radiothorium has a conveniently long half-life of nearly two years. Extractions of radiothorium can be obtained in a highly emanating state. A small quantity of iron chloride is added to a thorium solution and precipitated as a hydroxide by ammonia or as oxalate by oxalic acid. The precipitate, the hydroxide or oxalate of iron, is washed very carefully and dried at room temperature. This precipitate should have a high activity rate. It will not lose more than 20% of its initial activity rate for many months. This radiothorium preparation may be spread into a thin layer in a shallow brass tray placed at the bottom of a small lead-shielded container. The active deposit of thorium can be collected on a



negatively charged wire, insulated with respect to the container. The emanated **thoron** gas may also be absorbed into various materials.

The atomic ions emitted from radioactive isotopes can be directly converted to electrical power. My conversion method shown in Section 7, **Figure 5** can be used to convert this source of radiant energy. Additional stages can be added for more power. The circuit shown gives a general idea of how such an energy conversion device functions. By no means is this technology limited to this one circuit, configuration, or source of radiant energy.

### **Radon Super Catalyst**

My research has revealed that the energy devices of T. H. Moray, Alfred Hubbard, Reverend Antonio d'Angelo, and Joseph Papp all contained a source of radon gas. We know from the statements made by these inventors that they all used radium compounds in their energy devices. What we don't know for certain is if they were aware of the effects of the radon gas. When radon gas is contained in my ion-valve the applied electric field excites it. In its excited state it appears that it becomes a super catalyst before it decays to lead-210. Its reaction with the semiconductors within the valve release intermolecular electrons through the disintegration of the molecular binding force. The direct result is an increase in electrical conductivity within the valve. Sealed in the valve radon is not a health risk. High concentrations of cosmic rays are quite another issue. These are extremely short wavelength vibrations of high energy uncondensed matter. These are the particles that create radioactive thorium and uranium that we find in the ground. Cosmic particles or rays of atomic nuclei, call them what you will, are essentially minute particles called "neutrons" as Nikola Tesla had discovered. When they react with either thorium or uranium a radioisotope is created. Low concentrations of cosmic rays are consistently bombarding the earth. This is why you see a consistent percentage of U235 all over the planet. This percentage represents an accumulation of cosmic ray bombardment over the lifetime of our planet. High doses of cosmic rays released from splitting U235 atoms in a conventional nuclear reactor are lethal to living tissue. The natural concentration of cosmic rays that we are exposed to from day to day is up for debate.

Nature offers us cosmic energy that manifests itself in many different forms. Electricity is only one of its manifestations. From this knowledge we can obtain electrical power with no moving parts. The natural world contains many storehouses of this cosmic energy. We do not have to split atoms to obtain energy. Energy is all around us just waiting to be transformed.

Sir William Ramsey considered the action of ultra-violet light, moreover, as a kind of detonator, which produces the disintegration of the elements of matter.

Ultra-violet light acts like a spark on a mass of explosive material. This is to say that the energy emitted by the disintegration of matter in the form of electricity will be far superior to the energy that invoked it in the first place. The energy that is condensed in matter is immense. The result is that an enormous amount of energy is released with only a slight loss of matter.

Once enough funds are forthcoming I will build a high wattage cosmic energy converter. Through my writings, lectures and published articles I have attempted to explain my research. Over the years I have made my research available to the public and have asked for little in return. I am asking you at this point in time to help me to secure funding to get this technology implemented. As a former United States President once stated... "Sometimes when we reach for the stars, we fall short but we must press on". – *President Ronald Reagan*



## The Truth about Nuclear Science

Present day alternative energy researchers find hope in that, one day, power will be obtained from the energy that runs the Cosmos. In reality, this dream has only proved to be a lure to its followers, beyond the limits of credibility. A quagmire of unsubstantiated hypotheses exists that are bottomless and lack reality. The facts of many newly conceived energy concepts are wholly inadequate, lacking justification, and is incapable of throwing any light on the promise of inexpensive, abundant sources of energy.

The earth is indeed bathed in a sea of cosmic and solar energies. Can a device be built that can transform these energies into usable power? I believe that T. H. Moray did build such a device. This has inspired me to conduct my own research and to build my own prototypes. How the radiant energy device really worked might shock a few people once the facts become realized.

Nature is my best teacher. Within one of her classrooms there are mineral samples that give out pure electrical energy. They are the radioactive rocks. If radioactive matter from these rocks derives its energy elsewhere, this must be of a type entirely different from any presently known. It is capable of penetrating, without loss, hundreds of feet of solid rock.

Nikola Tesla's investigations brought him to the conclusion that the earth was being showered with "tiny particles, each carrying so small a charge that we are justified in calling them neutrons". He stated that "they move with great velocity, exceeding that of light".

Dr. Thomas Moray realized from Gustave Le Bon's research that matter is cosmic energy itself in condensed form. Le Bon demonstrated that matter is a stable form of atomic energy. Such a view appears to merge perfectly with the continuous and permanent activity of radium. This activity seems to last for an indefinite time. There appears to be no rational reason why radioactivity, however intense and powerful, should decay or diminish with the passage of time. Yet, disintegrating matter does decay. It is not perpetual. The demonstrated "half-life" values have proven that the stored energy within radiant matter will eventually be depleted.

At some point in my own research, I had to ask myself three important questions...

- 1) Is there anything opposed, either to reason or to probability, to the view that the energy evolved from radium is actually derived from an existing previously unsuspected internal process within the atom?
- 2) Within the decay process does the element experience a transformation into other elements?
- 3) How is it that such enormous stores of energy in matter have remained so long unknown?

We have learned that when a specimen of radium chloride is dissolved in water and the liquid is then evaporated and it is brought back to its dry state, as the result of this very simple operation, the radium loses the greater part of its radioactivity. The penetrating beta and gamma rays completely disappear. The remaining non-penetrating alpha rays will be only one quarter as



powerful as they were initially. Then a strange thing happens. Left alone, the radium will spontaneously recover its lost activity. Little by little, day by day, until at the end of a month, it will be no less active than it was before it went into solution. **I have also observed these same results with my own preparations.** These findings appear to be in direct conflict with the zealous statement that "radioactivity of radium cannot be affected by any known process". On studying the experiments carefully, we find that when radium chloride or one of my preparations is dissolved in water something escapes into the air. This "something" is intensely radioactive. It diffuses in the air, but will remain if contained within a gas-tight, closed vessel. In short, this "something" is a gas possessing the property of radioactivity to a very intense degree. This gas was called "emanation" in the days of old. Today it is called "radon gas". Uranium-238 generates **RADON-222**. It has a half-life of around 3.8 days. This radon gas is highly radioactive. Thorium releases **RADON-220** that is intensely radioactive and has a half-life of 55.6 seconds. Uranium-235 emits **RADON-219**, the most intensely radioactive substance, having a half-life of only 3.96 seconds.

Radon that has been separated from its parent source will rapidly decay. It is easy enough to conclude from this experiment that energy is stored within this atom. This accounts for the comparatively rapid decay of the activity of the generated radon gas. This gas is depleting its internal store of energy so rapidly that it is soon exhausted. On the other hand how is the gradual recovery of the radioactivity of its parent source explained? This question is the golden key to unlocking the secret of its power.

If it is true that energy comes from within, as large as the store of energy within the atom must be to explain its radioactivity, yet it cannot be infinite. Therefore, it is expected that the activity will slowly decay with the passing of time. Two radioactive bodies, one much more radioactive than the other, are compared together. It is expected that the activity of the more powerful body will decay faster than that of the other. A time will come for both of these substances, when the internal stores of energy are exhausted, that the radioactivity will come to an end. Therefore, radium, a substance containing the store of energy, can no longer be radium when the energy is lost. Coal is not coal after it is burnt. When energy is obtained from matter, the matter changes. Before it can be restored to its former state, the energy evolved must be put back. In no case, is it possible for matter to part with its store of chemical energy and remain the same, otherwise perpetual motion could be easily realized.

We can safely conclude that, if the energy is stored in the radium, it must be within the atom. Therefore, if radium changes, it must be a change of the atom and of the element itself. This change is due to its ultra-chemical reactions. This is a more fundamental and deep-seated change than the normal chemistry or any known kind of material change. Until the discovery of radioactivity, such changes certainly had never been observed. If the energy of radium comes from within, then it must be subjected to this ultra-chemistry that has eluded the chemist. This process of ultra-chemistry must be understood as a special extension of chemistry. It is not some vaguely possible, transcendental nuclear condition in the sun and stars. Once this is understood, the answers will become crystal clear.

Imagine that a month has passed. The radium chloride is once again dissolved in water and evaporated down to dryness exactly as before. Once more you will find in the process, that the radium has lost the same large proportion of its radioactivity. Again it gains a new amount of radon gas no less than before it went into solution. Repeat this experiment as often as you like. You will find the result always the same. The radon that you separate from the radium is decaying away from day to day. But the radium will also generate a spontaneous fresh new batch of radon. In order to make sense of this, we have to answer these nagging questions; "from where does the energy of



the radium come"? Does it come from nowhere, or is it being newly created out of nothing? This is a view that is not acceptable for a plausible twenty-first-century physical science.

If our doctrines of energy are true, then there are only two possible answers to consider. Either the energy must be derived from within the radium, or it must be supplied from elsewhere. This simple narrowing down of all the possible answers may appear to you somewhat simplistic, but in reality, it carries with it far more than appears on the surface. Being a minute property of the element, radioactivity is therefore a property of the atom. If we say that the energy comes from within, this means that there must exist an enormous and not previously suspected store of energy in matter.

Dr. Moray believed that radium merely retransmits energy that which it receives, that it converts the cosmic rays into electrical particles. He states that it retransmits energy in a form that we recognize. Tesla also entertained this view. There are electrical transformers dotted all over our country receiving transmitted but dangerous high-tension currents from the power stations. These are "transformed" into comparatively safe, low-tension currents for your house. Are the atoms of radium acting as the transformers of a mysterious and unknown source of external energy, first receiving it and then delivering it up again in a form that can be recognized? It may be said that so vague a view, postulating the existence of a limitless and mysterious supply of omnipresent energy, cannot be directly disproved. One thing is for certain: this view provides a way of escape from some of the more distasteful "logical" assertions, namely that all forms of energy are stored within the atoms and molecules. \*

If radium owes its activity to an energy source outside itself, one has only to isolate it. We have seen that to quench radioactivity, or to modify it in any way is one of the things mainstream science cannot do.

An experiment has proven that even in its natural state in the mine, hundreds of feet deep down in the earth, pitchblende exhibits its normal radioactivity. Over 100 years ago, scientists concluded that some sort of radiation must exist in the atmosphere. This conclusion arises because under all circumstances, air is found to have a slight positive concentration of ionized particles. These atoms are minus an electron. This radiation is constantly much stronger at high altitudes than at the earth's surface. This leads us to conclude that such radiation does not originate on this planet but rather from somewhere in the outer regions of space. The fact that the intensity of this radiation does not increase during daylight hours eliminates the sun as its source. Also, the intensity does not decrease during the day or increase by night, therefore it cannot be a result of any particular group of stars.

### **Spontaneous Decay**

Doesn't the "free emanating" state of a salt of radium teach anything about its decay mechanism? Results obtained by Dr. Alois Gaschler and Otto Hahn in the 1920's proved conclusively that when radium becomes finely divided, it most readily emits radon. This teaches us that radioactive change is effected by confinement. How many scientists have paid attention to this all-important lesson? Is it actually the true mechanism behind what is being called "fission"?

It is in my humble opinion that the seat of radioactivity is due to radon gas trapped within the lattice of certain heavy metals. The best comparison that I can think of is coal and the stored hydrogen gas within its lattice. Its stored hydrogen reserve reacts with oxygen transforming these two gasses into H<sub>2</sub>O with the release of heat. The carbon contained in the coal also reacts with oxygen when a high enough heat is generated from the hydrogen reaction and combustion occurs,



transforming the carbon and oxygen into CO<sub>2</sub>. Pretty much the same fundamental principle must occur when radon gas is released from its heavy metal prison. The reactant in this later case is a neutron from a previous radon gas emission. Radon reacts with a metal, losing a neutron to it. When this occurs, the radon becomes highly unstable, emitting alpha particles and rapidly transforming this gas into stable lead. From this reaction it is clear that radon is not as inert as we were lead to believe. In fact, I say that radon is at the very foundation of all nuclear reactions.

Since the discovery of radium by Madame Curie, the fundamental method of its extraction has not changed. The process utilizes the same methods that were instituted by Madame Curie and M. Debiere. Radioactive ores are first treated with a warm solution of hydrochloric acid that dissolves the metals. The addition of sulfuric acid precipitates the insoluble barite's that are always present, carrying along with them all the radium as barium sulfate. It is necessary that barium is present in the process. If the solution does not contain a sufficient quantity, then some barium has to be added. It is said that the barium acts as a "carrier" to the radium. Can there be any other explanation? It never made much sense to me why the radium would not precipitate out without the barium. I simply could not accept the notion that it only served as the carrier. The answer to this problem becomes relatively simple if you let Nature be your teacher. Forget what the textbooks tell you. We know from her lessons that radiation can be induced into non-radioactive elements, do we not? Could it be then, that something in the separated hydrochloric solution is transforming the barium into what we call radium? Ala-ka-zam, low and behold, there sure is, it is called URANIUM-235.

### **Nu Radium Formula**

Radium may be synthetically manufactured by fusing dry uranium nitrate mixed with about 0.5% of dry barium nitrate. This is done in the heat of an electric arc. The mass is then treated with nitric acid, water and sulfuric acid, successively. Radioactive barium sulfate, possessing all the physical properties of the "element" discovered by Madame Curie, is obtained through this formula. This material will emit ultra-violet rays, x-rays, excite phosphor screens and cause air to conduct electricity. The chloride and the carbonate of radium may also be created by using uranium chloride or uranium carbonate respectively and will display the same properties.

Uranium nitrate typically contains about 0.72 per cent **U235**. The barium reacts with the U235 creating pure radium. We now know for certain that the barium is not just a simple carrier as has been believed. Best results are obtained when 0.72 per cent barium is added, making it equal or less than the amount of U235 contained in the nitrate. If sulfuric acid is added after the reaction takes place, then radium sulfate is precipitated. This material can now be filtered for removal from the solution. A seemingly synthetically created radium salt results when barium forms a double salt with the U235 atom. It can not come into being otherwise. **All other radioisotopes might be called into existence in the presence of U235.** There are other processes involved but this will be explored at a future date. Radioisotopes created by ultra-chemical processes could have far reaching ramifications, if and when it is taken under the wing of mainstream science. Radioisotopes could be made to order literally in a jar. My findings appear to indicate that all radioactive substances originate from the U235 atom. Where did the U235 atom originate? I can only speculate at this point that it is created when a cosmic ray hits a stable U238 atom head-on. If my conclusions turn out to be correct, then the energy stored in radiant matter is a product of an external cosmic force and an internal force without contradiction.



## Clean Nuclear Reactors Are Possible

Mother Nature offers us a clean nuclear process to supply us with energy. My reasoning is based upon her process that leaves behind a clean, non-toxic ash. You have seen it in children's balloons at birthday parties. The inert gas that I am referring to here is called "helium". This is the only ash that is left behind by Nature's process. There are no deadly radio toxins like the ones found in the commercial reactor. It makes all the difference in creation how the reaction is carried out and for what purpose.

Spent nuclear plant material is bad stuff. When atoms are "split" like they are in a conventional nuclear reactor the course of nature is diverted and there are detrimental effects. My proposed processes could allow nature to go its own way. We would not be splitting the atoms like is done in conventional nuclear power plants and creating deadly nuclear by-products.

Not too many people now this but Virginia Beach is highly radioactive. Its sand contains monazite. This is a thorium ore. We do not need to worry about the natural stuff. Studies have shown that it is actually a benefit to our health.

The commercial nuclear reactor releases high concentrations of toxic radioisotopes. This is a direct result of the reaction of **URANIUM-235** haphazardly splitting into atomic fragments like glass. It is highly probable that we can design reactors that will release only pure electrical particles instead of the toxic radioisotopes that are created by stray fission fragmentation. Why not build clean reactors that do not generate these stray fragments? Nature accomplishes this everyday! Learning how nature accomplishes this feat will open the doorway to a safe reactor design. My extraction process could be part of the answer. Excess neutron generation could be eliminated. If we study the processes found in the natural world more closely we might obtain the knowledge to build a clean atomic reactor.

### Fundamental Atomic Guideline

1. Alpha bombardment of any element with atomic numbers from **1** through **15** will generate a new and stable element. One excess neutron will result from the reaction.
2. Neutron bombardment of any stable element from **16** and above will generate a new and unstable element through the capture of neutrons. One or more neutrons are released from the reaction. The targeted element will gain the weight of the absorbed neutrons. 
3. Neutron bombardment of an unstable element generates one helium-4 atom from each reaction. The atomic weight of the targeted element loses the weight of one helium-4 atom as a result of the reaction.
4. From these facts, it is not too hard to figure out that it is the beryllium, boron, or carbon control rods in a commercial nuclear reactor that are actually what supplies the initial neutron kick to begin the "fission reaction". The "moderator" provides high-speed protons to boost neutron production where there is not a high enough concentration of U235 to supply the required alpha particles. Scientists of yesteryear had been on the correct path. It was atomic bomb era mentality that took us off the narrow path. This was all in the name of "national security". It will only be when these facts resurface that advances will be made in the way we obtain energy.

## BOOK CONCLUSION

Funding has not permitted me to build a device that can power a home or electric car. However, my prototypes have proven beyond doubt that with the proper funding this can be accomplished. It is my hope, through the publication of my findings, that funding will be forthcoming. At this point in time, it is most important to me that I receive credit for my work and that my research discoveries do not fall on deaf ears.

Public tests are performed as necessary to validate the technologies. These demonstrations are deemed as research and development tests only. No power claims are expressed or implied at this time.

For almost fifteen years now I have carried out many experiments. The fruits of this research are ripening. Many fruits are within grasp but they are not yet quite ripe for the picking. The intent of revealing my progress to the World is to insure that this work is not done in vain. Through my writings I have attempted to explain the many facets of "radiant energy" and how it is possible to draw useable power from it. If radiant energy can be given to the World then humankind will have the potential to reach heights not yet dreamed or conceived. Today, I freely give to you the results of my life's work. Together we can reclaim our independence!

## ADDITIONAL REFERENCES

**The Evolution of Matter**  
by **Gustave Le Bon** 1907

**The Evolution of Forces**  
by **Gustave Le Bon** 1908

**Radiations from Radioactive Substances**  
by **Sir E. Rutherford, J. Chadwick, and C. D. Ellis** 1930, revised 1951

**The Interpretation of Radium and the Structure of the Atom** by **Frederick Soddy, M.A., F.R.S.** 1920

Annual Report of the Smithsonian Institution (1899) – **An Experimental Study of Radio-Active Substances** by **Henry Carrington Bolton** - see postscript **p. 162**

United States Patent No. 1,655,184 **Otto Haun** – Jan 3, 1928

United States Patent No. 1,644,370 **A. Gaschler** – Oct. 3, 1927



The x-rays begin at about the middle of the ultraviolet portion of the spectrum. These are called soft x-rays. Those that extend into the lower portion of the gamma range are called hard x-rays. Beyond this range, they are called cosmic rays. These energy disturbances are called "photons". They are not particles. They are disturbances caused by the kinetic states of particles in motion. This energy spectrum proceeds in order of decreasing wavelength; sound, thermal, visible light, ultraviolet, gamma, and the cosmic rays.

### Pair Production

If a photon has sufficient energy, its energy may be absorbed by atoms. The photon interacts with electrons. This gives rise to a process called "pair production", in which the energy of the photon is absorbed by the atom.

### Photo Disintegration by Gamma Energy

Atoms can absorb high-energy x-ray photons, those with energies above 10MeV (Million electron Volts). Here, the electrons within atoms are raised to an excited state and instantaneously emit high-energy gamma radiation. This makes the atom receptive to nuclear transformation. This process is called "photo-disintegration".

### 1.02MeV Energy Barrier

It has been calculated that when one electron pairs with another, 0.51MeV of photon energy results. Since two electrons are involved in a pair production event, a photon must have at least 1.02MeV of energy to separate them. A photon with less than 1.02MeV will not produce a pair production event. Any energy in excess of 1.02MeV is distributed equally between the two electrons.

### Electrical Energy – Electron Cloud

An atom is negatively ionized when it gains electrons. The atom is positively ionized when it loses electrons. How can it be then that a (helium particle) expelled from radioactive decay is charged to (millions of volts positive?) This observation can mean only one thing, that the electron shells are really an abstract thought for mathematical calculations, when concretely the atom is a mixture of electrons, neutrons and protons. The electron cloud consists of thousands of actual electrons. It must be noted that an electron is approximately 1,830 times smaller than the mass of a proton. The scientific community has ignored this little fact. As an example it will take around 1,830 electrons to equal the mass of one proton in the hydrogen atom. So, it is said that there is one proton and one electron in the hydrogen atom. What really should be said is that there is one proton and approximately 1,830 electrons. However, it is much easier to state that there is one electron in the hydrogen atom for simplicity. The mathematical electron shell theory need not be modified to fit this reality. It is convenient to use the square root of the actual number of electrons that surround each nucleus, for day to day chemical formulations.

\* —  
helium + hydrogen  
doorways  
for ether & ZPR

X — When electrons or negative ions rush towards a positively charged atom in order to reach equilibrium, it is said that an electric current is generated. This current is created by a particular energy state called "voltage". If a metallic conductor has electrical current flowing in one direction then one end of the conductor has an excess of electrons. The opposite end has a deficit of electrons. All "electric oscillations" are a result of this phenomenon. Battery power, direct current generators, alternating current alternators, radio, microwaves, radar, electronic oscillators,

metallic coils and condensers, electron-tubes, ion-tubes and transistors, magnetrons, klystrons, lasers, masers and molecular transitions; all carry these oscillations.

So then, what is electricity? This question has eluded the most able intellects throughout human history. Could this be because science has ignored the fact that the electron in an atom is actually representing more than one thousand electrons, not just one? As observation shows, two states of energy exist, one "negative" and the other "positive". How could it be that there are two states, identical in their properties, opposite in character, both clinging to matter, both attracting and yet completely neutralizing each other? From this analogy, it is safe to say that electron differences create the effects of electricity.

## **Chemical Cohesion**

Atoms are attracted by virtue of their differing kinetic phase relationships. Matter stays together because of this principle. Atoms are continually expanding and contracting in unison with their kinetic frequencies. Expanding particles are attracted to contracting ones and visa-versa. "Gravitation" might turn out to be a grand display of this phenomenon. Atoms will repel atoms only if they are in the state of coherent kinetic vibration. This occurs when atoms are vibrating in phase with each other. Coherence will raise energy levels. Differing elements will form "compounds" when their fundamental frequencies are in accord with each other. They must ring harmoniously.

## **Ultra Chemistry**

The first law of thermodynamics describes the principle of the conservation of energy. It states that "energy is not created or destroyed; it merely changes form". The fact is that the creation or destruction of energy is a result of matter being broken down or built up. They both go hand in hand.

I strongly believe that the three primary particles were created at the beginning of the universe and that they can not be destroyed. However, the good news is that to serve our needs we can artificially alter the combinations of the protons, neutrons and electrons found in matter.

I will dare to further state that neutrons not only reside in the "nucleus", but they also exist throughout the atom as a homogenous mix with the other primary particles. The most simplistic expression of the **Perreault Atom** involves the bold statement that neutrons reside in balance with the protons and electrons within the atoms. This concept applies throughout the entire Periodic Chart of the Elements.

## **Isotopes**

Three hydrogen elements (isotopes) are known to exist that are chemically similar but have different weights. The three weigh differently due only to neutron content. These are all hydrogen atoms. However, it is the neutron count in the atomic shell that determines what isotope it is.

It is clearly established that triple weight hydrogen (tritium) decays to helium-3. In this particular transformation a charged normal weight hydrogen element (protium) carries an excess electron in its shell. It can react with tritium and emit an electron as a by-product of the reaction. At this moment the electron is emitted at an accelerated rate and is seen as beta energy. This model will not alter the way we view chemistry, however, nuclear transformations should be seen differently.



## Gravitation

Each individual atom is at the center of its own universe and has a unique resonant frequency that is representative of its specific mass. Lithium for example has a greater mass than the hydrogen atom and will vibrate at a lower frequency in comparison. Therefore, we may say that it is caught by the earth's gravitational pull more readily and has more weight. This may help to explain how physical objects are attracted to the earth.

## Stored Nuclear Energy

Have you ever wondered about spontaneous radioactive decay? Is it really a super charged state of matter? If an atom can become ionized by either gaining or by losing electrons then why can there not be a nuclear ionization too? I hypothesize that atoms do become ionized on the nuclear level by gaining or losing neutrons. This may appear incidental but could be at the very heart of an ultra-chemistry. I say that it is highly likely that this very phenomenon is behind natural spontaneous radioactive decay and explains many unanswered questions about nuclear science.

Atoms can gain or expel neutron particles, some to a greater or lesser degree. Thorium can readily be transformed into a fissile isotope of uranium by absorbing neutrons. It is a known fact that thorium stores more energy than uranium, coal, oils and all other fuels combined. This represents a tremendous amount of stored energy. Thorium could be our most economic source of energy. It is almost as abundant as the element lead.

\* — It is only by passing from one state of equilibrium to another that matter can lose or gain energy, consequently emitting radiation. The notion that radioactivity originated in a peculiar chemical process was adopted and defended by Rutherford. "Radioactivity", says he, "is due to a succession of chemical changes". My research seems to indicate that this "succession" is due to neutron transformation.

## Nuclear Transformation

Elements that absorb neutrons and become unstable are called "radioisotopes". When an atom absorbs neutrons it is seen as a "fusion" reaction. When an atom loses neutrons, it is seen as a "fission" reaction. All elements can "transform" into a radioisotope and visa-versa. Radioactive isotopes are unstable and will transform into stable elements. A radioactive isotope will eventually revert back to the original element on its own accord. A radioisotope is a natural storehouse of energy. We need not look any farther for our energy needs. Nature holds an inexhaustible supply.

## Induced Radioactivity

When bismuth is exposed to radium, initially it becomes several hundred times more active than the radium. This is due to emanation that clings to the surface of the bismuth. Emanation is widely known as radon gas that will eventually decay to polonium. It releases more energy than any single natural element that has been discovered.

If beryllium is exposed to radium, neutrons are generated. These neutrons will have penetrating power several times that of the most energetic gamma energies. This activity is due, not to an alteration of the inactive matter itself, (but to an admixture) of a very small quantity of intensely active matter. Does the increased activity occur when matter gains or losses neutrons? Could it be that a neutron is actually an inert monatomic gas? This would certainly explain a few gaps in

accepted atomic theory. Could it be that radioactive matter is simply in an atomically charged state? It is recognized that when an atom gains or loses electrons, it becomes "charged". However, I have taken this one step further by suggesting that matter will also become super charged when it gains or loses neutrons.

## Strange Nuclear Facts

Primary neutron particles and gamma energy levels are generated in nuclear transformations. This results in the atom becoming super charged.

A "chain-reaction" in radioactive matter is due to the concentration of its excess neutrons that it contains. The greater the concentration of excess neutrons, the more accelerated the decay process becomes.

For example, if beryllium metal is added to radium metal, neutrons are generated. These neutrons can be used to cause secondary nuclear reactions in a fissile material. The beryllium becomes the nuclear trigger.

The energy released by the transformation of beryllium is estimated to be at around 50MeV and that of boron nearly as large. The excess neutrons generated can be used to super charge atoms thus transforming them into radioisotopes.

## Cold Fusion

Here is a "cold fusion" reaction to consider. Radon gas (a pure alpha emitter) generated from the decay of radium is deposited onto a beryllium wire. The beryllium in reacting with an excited alpha particle will generate a "cold fusion" reaction without the need for excessive heat, as is the case for "hot fusion". The reaction that results is:  ${}_4\text{Be}^9 + {}_2\text{He}^4 \rightarrow {}_6\text{C}^{12} + {}_0\text{n}^1 = \text{cold fusion}$ . The secondary neutron particles generated can now trigger a chain-reaction in nuclear fuels. Atoms need not become fragmented from the above reaction. Therefore, the reaction is "clean". There are other examples but this formula will give you the general idea.

Alpha fusion is actually a cold fusion reaction. The end result generates neutrons from the production of fusion by alpha particle absorption. A simple equation where mass squared by its speed equates to temperature. This equation can be applied to a kinetically energetic alpha particle in my model. Simply stated, a fusion reaction occurs when there is a temperature differential between the alpha particle and the target that it impinges upon. It must also be noted that if no new neutrons result from the reaction then the reaction is considered to be a clean nuclear reaction.

The over-all alpha fusion reaction is cold. This is in contrast to reactions that produce excess residual heat. For example, a heat pump will absorb hot particles from the cold air of winter. The average temperature is cold. We can apply this to alpha fusion. The average over-all alpha fusion reaction is cold. You may still consider the reaction to be hot. In fact, it is in every real sense of the word. Even so, the term cold fusion is a non-mathematical one. We can use it to denote the difference between reactions that result from a CERN particle reactor and those that are naturally directed by ultra chemical reactions. As you can see, I do not buy into what the textbooks say about what constitutes a nuclear reaction as compared to a chemical reaction. All reactions are chemical in my point of view. The sited alpha reaction is an ultra extension of chemistry. The textbooks have over complicated the "nuclear reaction" in my assessment and in doing so have fogged the truth in many instances.



## Some Ignored Uranium Facts

1. U235 emits ultraviolet light. \* Galen Winsor, "Nuclear Scare Scam" – lecture
2. U238 expels electrons most readily when exposed to a wavelength of 3000 Angstroms in the ultraviolet spectrum. \* Rentschler, A. I. E. E. 1930, p. 49 & p. 576
3. The UV light wavelength of 254 nanometers is a catalyst to oxidation processes.
4. The 254 nanometer frequency of light kills viruses, molds and other pathogens by rendering their DNA inactive. It therefore disinfects drinking water.
5. The human skin is reddened (erythema) and is most sensitive to the wavelength of 3000 Angstroms (254 nanometer range). \* Hauser and Vahle, *Strahlentherapie*, 1921, p. 13 & p. 41

## The Effects of Radon Gas Excitation

When radon gas is electronically excited it generates a healing energy. This particular type of radiant energy possesses great powers of penetration, exceeding, in fact, the penetrating powers of ordinary x-rays. These rays have been proven to be harmless and may be used, if desired, to produce clear radiographs. They are antiseptic, germicidal, and are good tissue builders possessing wonderful healing powers. They will also effect photographic plates, produce phosphorescence in certain substances, render the surrounding air conductive to electricity and can produce heat in some materials. What this means is that ion-valves that are used in the circuitry to generate electrical power could have the side benefit of improving our health. A patent that utilized excited radon for health benefits was granted to L. Winklemann titled "Radioactive Vacuum Tube" U.S. Patent No. 1,466,777 – Sept. 4, 1923.

Many chemical processes and reactions that do not normally take place, or that proceed with difficulty will occur under the action of excited radon gas. Moray stated that he was able to create rubber without the addition of sulfur by exposing his rubber solutions to the rays for a short period of time. He was also able to produce a metal that would not heat when drilled. Treated metal bearings by his process were used in his high rpm, high frequency motors.

## Liberated Energy

With a slight excitement from a thin beam of invisible radiant energy, or even with no excitement at all, as we observe in spontaneously disintegrating radioactive bodies, such as U235, we can obtain large quantities of energy. Clearly, we did not create this liberated energy, since it already exists in matter, but we release it under the right conditions. This is being done without violating the law of energy conservation. The idea that matter could be transformed into energy was absurd before the acknowledgement of nuclear transformations.

A Nu Science is on the horizon. It involves the means of transforming matter into energy without splitting atoms. This science recognizes several isotopes of matter that spontaneously liberate energy as observed in naturally occurring radioisotopes. It is possible to speed up the natural decay process using a minute excitement as from a ray of ultra-violet light, etc... With a very small quantity of energy we will be able to produce a very large quantity of energy without splitting the atoms. My process speeds up the natural decay process without generating harmful by-product nuclear wastes.

## Alpha Fusion

"Alpha fusion" is an amazing natural process. Here is a comparison of the energy released per atom of uranium that undergoes fission versus alpha fusion, via neutron absorption.

$$\begin{array}{l} \text{U235 fission}=161,000 \text{ kWh/kg (} 2 \times 10^8 \text{ BTU/lb.)} \\ \text{vs.} \\ \text{Alpha fusion}=1.68 \times 10^{11} \text{ kWh/kg (} 2.6 \times 10^{14} \text{ BTU/lb.)} \end{array}$$

The potential implication of this alpha fusion formula staggers the imagination. There is a lot of room for innovation and creativity. Imagine having a device that could safely provide power for several decades without recharging. Sounds almost like science fiction you say? It is a scientific fact! Plutonium-238 is a non-fissile isotope that decays by **alpha particle** emission with essentially zero associated gamma emissions. This type of plutonium spontaneously produces about one kilowatt of energy for two kilograms of mass. This reaction will release alpha particles that can only travel a short distance before they are stopped. This process decreases slowly over time. After ten years the energy production is about 92 percent of the initial value. Even after 87 years the material produces about half as much energy as when it was first started.

When positively charged helium atoms (alpha particles) collide with the **electron cloud** that envelops another atom the positive charge is eventually canceled by these collisions. This is called "absorption". Atoms ring like a bell when impinged upon by alpha particles. This ringing state generates **x-rays**. The wavelength of this generated x-ray depends on the charge of the alpha particle and what type of atom it hits. If the x-ray generated has an energy level that exceeds 10MeV, atoms absorb it. In this case, the neutrons are raised to an excited state. They may be broken loose from the shells of an element or a neutron may be added to a shell. Gaining or losing neutrons via this process can create radioisotopes. We can efficiently do this by exposing atoms to alpha particles. In the process matter and energy is neither created nor is it destroyed.

Generally, the formation of a chemical compound is accompanied by the release of a definite amount of heat per unit mass of the substance formed. The burning of a fuel is a chemical reaction in which oxygen is consumed. The quantity of heat released when a unit of fuel is burned with oxygen is called the "heat of combustion". For the average coal, this value is from 7,000 to 8,000 calories per gram or 12,000 to 14,000 BTUs per pound.

In contrast, **radioisotopic** transformation is accompanied by the release of enormous energy when compared to conventional oxygen – electron oxidation. However, this does not justify the theory advanced that neutrons occupy the center of atoms. It is my hypothesis that neutrons reside in the orbital shells of elements and not within the nucleus. To envision this atomic structure one only has to look at our own solar system to see this on a grand scale. Isotopic oxidation (neutron oxidation) simply involves the neutrons. However, the energy involved is much greater because the neutrons represent neutral charge and therefore the binding energy of the elemental shells is of a greater magnitude altogether.



When the unstable isotope of an element reverts back to its original stable state energy is released in the transformation. Now, consider what will happen if we tune into the resonant frequency of an unstable isotope like naturally occurring U235. By tuning into its resonant frequency we would make it ring like a bell. Assuming its absorption wavelength is correct, according to the resonant frequency of this element, its instability would increase, its stored reserve of energy would be released. This could be done with any isotope. However, U235 will "self-fission" and under the right conditions, will not require any source of energy other than what it emits. Excess energy is released only after enough neutrons are captured to cause the transformation of the U235 atom. This is called the "break even" point, beyond which excess energy is released to effect a "chain-reaction". Therefore, only a minute amount of energy is required to ring this atom like a bell.

We are not limited to the U235 isotope to use as our fuel source. This element is used in a commercial nuclear reactor because it undergoes self-fission and requires no additional catalyst in order to "burn". The public does not generally know that the U238 in a commercial reactor does not undergo fission. The only reason for its presence is to capture neutrons that transform it into weapons grade Pu239.

U238 will "fission" via fast neutrons generated by the alpha fusion process. However, there is one small hitch to the alpha fusion process. A nuclear fusion fuel material is needed along with the U238 alpha emitter. This material generates the required fast neutrons for this type of fission. All that is needed is the right type of spark to speed up the decay rate. Radium, radiothorium, U235 can be used as the alpha source. Beryllium, boron, or carbon can be used as the fusion catalyst. Any of the elements below periodic number fifteen feasibly could be utilized. However, these three elements sited pack the most wallop. The alpha fusion formula that I have described points the way to a simple and economical atomic process. Virtually no excess neutrons would result that would lead to a toxic waste problem. Fully depleted U238 could be used that does not contain U235. Instead of making nuclear bullets, like the ones used in the Gulf War, we could be using our reserves of depleted uranium as a beneficial fuel source.

Plutonium is not feasible at this time, so plain old, natural, untreated uranium will do the job. One pound of "yellow-cake" ( $U_3O_8$ ) is equivalent to 31 barrels of oil or 10 tons of coal. At the time of this writing yellow cake costs less than \$10.00 per pound.

For political reasons' people, organizations and government agencies have strongly opposed the use of all forms of nuclear energy. These people have made the general population paranoid of any and all radioactive materials. Despite this strong opposition and threats against its development, work continues with the dream of harnessing its transformations safely. The atom makes energy available to us. I have proposed a radical atomic theory to explain the nuclear energy process. Conventional atomic theory has many flaws in my assessment. It does not completely explain the energy created by a nuclear reaction. Does this mean that the nuclear reactor does not completely create energy? No matter what theory you wish to use in explaining atomic power, the fact still remains that energy is transformed.

James Chadwick discovered the neutron in February 1932. Later, further studies were made to discover what effects would be produced by bombarding different materials with this new particle. Researchers for the next several years bombarded every known element with neutrons and recorded hundreds of new radioactive isotopes. My own research in this area has revealed many secrets of the vast reservoirs of energy contained within the atoms.

## Electronically Activated Neutron Source

In the winter of 1996, I applied a 90,000-volt negative charge to a carbon rod. This carbon rod was surrounded with radioactive ore in a closed container. Under these conditions, the radon gas emitted from the ore was attracted and absorbed into the charged rod. This marked the beginning of my research into ion assisted atomic transformations.

The initiator for the first plutonium weapon was composed of polonium coated onto beryllium. The polonium came from the Radium Chemical Company.

"It must be first remarked that helium is a gas which accompanies all radioactive minerals. It was from these bodies that it was first obtained – a catalyst with an interesting effect."

"This derivation from radium is a **special helium** since it appears to possess the property of spontaneously vanishing. Its' only resemblance to ordinary helium seems to consist of the momentary presence of some spectral rays." \* The Sea of Energy by T.H. Moray, 1978 fifth edition, pages 229-230.

The results of my life-long research have opened a doorway that could lead to electronically induced nuclear fusion. I originally named this process "alpha fission" to connote this electronically induced atomic reaction. The term was chosen so as to cause the least adverse social reaction to this discovery, due to the fact that the public has been duped into a state of paranoia by its global governments. Later, this term was changed to alpha fusion, as this is a more accurate term than the original chosen term.

Conventional nuclear reactors generate deadly toxic radioactive wastes as by-products. These reactors are even more deadly than anyone realizes. Fuel rods in the reaction process are extremely hot and are subjected to enormous internal pressures. Untold dangerous amounts of radon gas could leak into our environment if the fuel rods become overheated. We must take a close look at clean nuclear processes before it is too late (if it isn't already).

With the advent of electronically triggered neutrons, a self-sustaining chain reaction can be obtained and may be highly controlled. I find this especially true if **thorium ore** were to be used. Thorium emits **thoron** ( $Rn^{220}$ ). Owing to its extremely short half-life, thoron by itself can not be used as a source of strong radiation. However, in conjunction with its parent substance radiothorium, it can indeed be used as a strong source of radioactivity.

Thoron has a short half-life of 54.5 seconds. On the other hand Radon-222 has a considerably long half-life of 3.5 days making it a hazard. Thoron is safe and convenient to work with because there are no long-lived products in its disintegration chain. Therefore, there is minimal danger of permanent contamination. The parent substance, radiothorium, may be obtained from thorium solutions in the manner described next.

Radiothorium is generally used as a parent source of thoron. Radiothorium has a conveniently long half-life of nearly two years. Extractions of radiothorium can be obtained in a highly emanating state. A small quantity of iron chloride is added to a thorium solution and precipitated as a hydroxide by ammonia or as oxalate by oxalic acid. The precipitate, the hydroxide or oxalate of iron, is washed very carefully and dried at room temperature. This precipitate should have a high activity rate. It will not lose more than 20% of its initial activity rate for many months. This radiothorium preparation may be spread into a thin layer in a shallow brass tray placed at the bottom of a small lead-shielded container. The active deposit of thorium can be collected on a



negatively charged wire, insulated with respect to the container. The emanated **thoron** gas may also be absorbed into various materials.

The atomic ions emitted from radioactive isotopes can be directly converted to electrical power. My conversion method shown in Section 7, **Figure 5** can be used to convert this source of radiant energy. Additional stages can be added for more power. The circuit shown gives a general idea of how such an energy conversion device functions. By no means is this technology limited to this one circuit, configuration, or source of radiant energy.

### **Radon Super Catalyst**

My research has revealed that the energy devices of T. H. Moray, Alfred Hubbard, Reverend Antonio d'Angelo, and Joseph Papp all contained a source of radon gas. We know from the statements made by these inventors that they all used radium compounds in their energy devices. What we don't know for certain is if they were aware of the effects of the radon gas. When radon gas is contained in my ion-valve the applied electric field excites it. In its excited state it appears that it becomes a super catalyst before it decays to lead-210. Its reaction with the semiconductors within the valve release intermolecular electrons through the disintegration of the molecular binding force. The direct result is an increase in electrical conductivity within the valve. Sealed in the valve radon is not a health risk. High concentrations of cosmic rays are quite another issue. These are extremely short wavelength vibrations of high energy uncondensed matter. These are the particles that create radioactive thorium and uranium that we find in the ground. Cosmic particles or rays of atomic nuclei, call them what you will, are essentially minute particles called "neutrons" as Nikola Tesla had discovered. When they react with either thorium or uranium a radioisotope is created. Low concentrations of cosmic rays are consistently bombarding the earth. This is why you see a consistent percentage of U235 all over the planet. This percentage represents an accumulation of cosmic ray bombardment over the lifetime of our planet. High doses of cosmic rays released from splitting U235 atoms in a conventional nuclear reactor are lethal to living tissue. The natural concentration of cosmic rays that we are exposed to from day to day is up for debate.

Nature offers us cosmic energy that manifests itself in many different forms. Electricity is only one of its manifestations. From this knowledge we can obtain electrical power with no moving parts. The natural world contains many storehouses of this cosmic energy. We do not have to split atoms to obtain energy. Energy is all around us just waiting to be transformed.

Sir William Ramsey considered the action of ultra-violet light, moreover, as a kind of detonator, which produces the disintegration of the elements of matter.

Ultra-violet light acts like a spark on a mass of explosive material. This is to say that the energy emitted by the disintegration of matter in the form of electricity will be far superior to the energy that invoked it in the first place. The energy that is condensed in matter is immense. The result is that an enormous amount of energy is released with only a slight loss of matter.

Once enough funds are forthcoming I will build a high wattage cosmic energy converter. Through my writings, lectures and published articles I have attempted to explain my research. Over the years I have made my research available to the public and have asked for little in return. I am asking you at this point in time to help me to secure funding to get this technology implemented. As a former United States President once stated... "Sometimes when we reach for the stars, we fall short but we must press on". – *President Ronald Reagan*

## The Truth about Nuclear Science

Present day alternative energy researchers find hope in that, one day, power will be obtained from the energy that runs the Cosmos. In reality, this dream has only proved to be a lure to its followers, beyond the limits of credibility. A quagmire of unsubstantiated hypotheses exists that are bottomless and lack reality. The facts of many newly conceived energy concepts are wholly inadequate, lacking justification, and is incapable of throwing any light on the promise of inexpensive, abundant sources of energy.

The earth is indeed bathed in a sea of cosmic and solar energies. Can a device be built that can transform these energies into usable power? I believe that T. H. Moray did build such a device. This has inspired me to conduct my own research and to build my own prototypes. How the radiant energy device really worked might shock a few people once the facts become realized.

Nature is my best teacher. Within one of her classrooms there are mineral samples that give out pure electrical energy. They are the radioactive rocks. If radioactive matter from these rocks derives its energy elsewhere, this must be of a type entirely different from any presently known. It is capable of penetrating, without loss, hundreds of feet of solid rock.

Nikola Tesla's investigations brought him to the conclusion that the earth was being showered with "tiny particles, each carrying so small a charge that we are justified in calling them neutrons". He stated that "they move with great velocity, exceeding that of light".

Dr. Thomas Moray realized from Gustave Le Bon's research that matter is cosmic energy itself in condensed form. Le Bon demonstrated that matter is a stable form of atomic energy. Such a view appears to merge perfectly with the continuous and permanent activity of radium. This activity seems to last for an indefinite time. There appears to be no rational reason why radioactivity, however intense and powerful, should decay or diminish with the passage of time. Yet, disintegrating matter does decay. It is not perpetual. The demonstrated "half-life" values have proven that the stored energy within radiant matter will eventually be depleted.

At some point in my own research, I had to ask myself three important questions...

- 1) Is there anything opposed, either to reason or to probability, to the view that the energy evolved from radium is actually derived from an existing previously unsuspected internal process within the atom?
- 2) Within the decay process does the element experience a transformation into other elements?
- 3) How is it that such enormous stores of energy in matter have remained so long unknown?

We have learned that when a specimen of radium chloride is dissolved in water and the liquid is then evaporated and it is brought back to its dry state, as the result of this very simple operation, the radium loses the greater part of its radioactivity. The penetrating beta and gamma rays completely disappear. The remaining non-penetrating alpha rays will be only one quarter as



powerful as they were initially. Then a strange thing happens. Left alone, the radium will spontaneously recover its lost activity. Little by little, day by day, until at the end of a month, it will be no less active than it was before it went into solution. **I have also observed these same results with my own preparations.** These findings appear to be in direct conflict with the zealous statement that "radioactivity of radium cannot be affected by any known process". On studying the experiments carefully, we find that when radium chloride or one of my preparations is dissolved in water something escapes into the air. This "something" is intensely radioactive. It diffuses in the air, but will remain if contained within a gas-tight, closed vessel. In short, this "something" is a gas possessing the property of radioactivity to a very intense degree. This gas was called "emanation" in the days of old. Today it is called "radon gas". Uranium-238 generates **RADON-222**. It has a half-life of around 3.8 days. This radon gas is highly radioactive. Thorium releases **RADON-220** that is intensely radioactive and has a half-life of 55.6 seconds. Uranium-235 emits **RADON-219**, the most intensely radioactive substance, having a half-life of only 3.96 seconds.

Radon that has been separated from its parent source will rapidly decay. It is easy enough to conclude from this experiment that energy is stored within this atom. This accounts for the comparatively rapid decay of the activity of the generated radon gas. This gas is depleting its internal store of energy so rapidly that it is soon exhausted. On the other hand how is the gradual recovery of the radioactivity of its parent source explained? This question is the golden key to unlocking the secret of its power.

If it is true that energy comes from within, as large as the store of energy within the atom must be to explain its radioactivity, yet it cannot be infinite. Therefore, it is expected that the activity will slowly decay with the passing of time. Two radioactive bodies, one much more radioactive than the other, are compared together. It is expected that the activity of the more powerful body will decay faster than that of the other. A time will come for both of these substances, when the internal stores of energy are exhausted, that the radioactivity will come to an end. Therefore, radium, a substance containing the store of energy, can no longer be radium when the energy is lost. Coal is not coal after it is burnt. When energy is obtained from matter, the matter changes. Before it can be restored to its former state, the energy evolved must be put back. In no case, is it possible for matter to part with its store of chemical energy and remain the same, otherwise perpetual motion could be easily realized.

We can safely conclude that, if the energy is stored in the radium, it must be within the atom. Therefore, if radium changes, it must be a change of the atom and of the element itself. This change is due to its ultra-chemical reactions. This is a more fundamental and deep-seated change than the normal chemistry or any known kind of material change. Until the discovery of radioactivity, such changes certainly had never been observed. If the energy of radium comes from within, then it must be subjected to this ultra-chemistry that has eluded the chemist. This process of ultra-chemistry must be understood as a special extension of chemistry. It is not some vaguely possible, transcendental nuclear condition in the sun and stars. Once this is understood, the answers will become crystal clear.

Imagine that a month has passed. The radium chloride is once again dissolved in water and evaporated down to dryness exactly as before. Once more you will find in the process, that the radium has lost the same large proportion of its radioactivity. Again it gains a new amount of radon gas no less than before it went into solution. Repeat this experiment as often as you like. You will find the result always the same. The radon that you separate from the radium is decaying away from day to day. But the radium will also generate a spontaneous fresh new batch of radon. In order to make sense of this, we have to answer these nagging questions; "from where does the energy of



the radium come"? Does it come from nowhere, or is it being newly created out of nothing? This is a view that is not acceptable for a plausible twenty-first-century physical science.

If our doctrines of energy are true, then there are only two possible answers to consider. Either the energy must be derived from within the radium, or it must be supplied from elsewhere. This simple narrowing down of all the possible answers may appear to you somewhat simplistic, but in reality, it carries with it far more than appears on the surface. Being a minute property of the element, radioactivity is therefore a property of the atom. If we say that the energy comes from within, this means that there must exist an enormous and not previously suspected store of energy in matter.

Dr. Moray believed that radium merely retransmits energy that which it receives, that it converts the cosmic rays into electrical particles. He states that it retransmits energy in a form that we recognize. Tesla also entertained this view. There are electrical transformers dotted all over our country receiving transmitted but dangerous high-tension currents from the power stations. These are "transformed" into comparatively safe, low-tension currents for your house. Are the atoms of radium acting as the transformers of a mysterious and unknown source of external energy, first receiving it and then delivering it up again in a form that can be recognized? It may be said that so vague a view, postulating the existence of a limitless and mysterious supply of omnipresent energy, cannot be directly disproved. One thing is for certain: this view provides a way of escape from some of the more distasteful "logical" assertions, namely that all forms of energy are stored within the atoms and molecules. ✖

If radium owes its activity to an energy source outside itself, one has only to isolate it. We have seen that to quench radioactivity, or to modify it in any way is one of the things mainstream science cannot do.

An experiment has proven that even in its natural state in the mine, hundreds of feet deep down in the earth, pitchblende exhibits its normal radioactivity. Over 100 years ago, scientists concluded that some sort of radiation must exist in the atmosphere. This conclusion arises because under all circumstances, air is found to have a slight positive concentration of ionized particles. These atoms are minus an electron. This radiation is constantly much stronger at high altitudes than at the earth's surface. This leads us to conclude that such radiation does not originate on this planet but rather from somewhere in the outer regions of space. The fact that the intensity of this radiation does not increase during daylight hours eliminates the sun as its source. Also, the intensity does not decrease during the day or increase by night, therefore it cannot be a result of any particular group of stars.

### **Spontaneous Decay**

Doesn't the "free emanating" state of a salt of radium teach anything about its decay mechanism? Results obtained by Dr. Alois Gaschler and Otto Hahn in the 1920's proved conclusively that when radium becomes finely divided, it most readily emits radon. This teaches us that radioactive change is effected by confinement. How many scientists have paid attention to this all-important lesson? Is it actually the true mechanism behind what is being called "fission"?

It is in my humble opinion that the seat of radioactivity is due to radon gas trapped within the lattice of certain heavy metals. The best comparison that I can think of is coal and the stored hydrogen gas within its lattice. Its stored hydrogen reserve reacts with oxygen transforming these two gasses into H<sub>2</sub>O with the release of heat. The carbon contained in the coal also reacts with oxygen when a high enough heat is generated from the hydrogen reaction and combustion occurs,



## Polonium Chemistry

Polonium-210 is a low-melting, fairly volatile metal, 50% of which is vaporized in air in 45 hours at 131°F. It is an alpha emitter with a half-life of 138.39 days. A milligram emits as many alpha particles as five grams of radium. This represents a whopping five curies per 1/1000<sup>th</sup> of a gram, making Polonium 5,000 times more powerful than radium. The energy released by its decay is so large (140W/g) that an insulated capsule containing about half a gram reaches a temperature above 932°F. A few curies of polonium exhibits a blue glow, caused by excitation of the surrounding gas. Almost all its alpha radiation is stopped within the container that it is stored, where it gives up its energy.

The maximum permissible body burden for ingested polonium is only 0.03 micro-curies, which represents a particle weighing only  $6.8 \times 10^{-12}$  12g. Weight for weight it is about  $2.5 \times 10^{11}$  times as toxic as hydrocyanic acid. The maximum allowable concentration for soluble polonium compounds in air is about  $2 \times 10^{-11}$  microcuries/cm<sup>3</sup>.

It is said that polonium is very dangerous to handle in even milligram or microgram amounts. This is stated due to the damage that arises from the complete absorption of the energy of the alpha particle into living tissue. Like anything else, there are little risks if it is respected. From the above data that we have on polonium we are told that if we get polonium into our blood stream through an open wound on the body it could be fatal. With this said, if an ion-valve contains radon gas that has decayed to polonium over several years I strongly advise that you do not unseal it – for safety sake. With this in mind you should properly dispose of old tubes. It is better to be safe.

On another note, the concern about radiation poisoning is fully justified under certain conditions. A meltdown of a conventional nuclear reactor can release deadly strontium-90 and radioactive iodine into the air. Atomic bombs also release deadly radioisotopes. This is an atomic ash that is called "fallout". Military shells using depleted uranium will release particles less than 5 microns in size on impact with the target. When uranium becomes finely divided and enters the body it becomes a deadly toxin. My system of radiant energy conversion poses zero health risk. One reason being is that no deadly isotopes are generated as is in the case of conventional reactors.

On the other hand, radon gas enhanced ion-valves used to generate electrical power will have no harmful side effects because the amount used is minute. This is provided that you do not unseal the tubes. In fact, the excited radon gas has been observed to have actual health benefits as I have already discussed.

### Is Radium a Real Element?

It was Madame Curie who determined the weight of radium. She determined its weight by observing the weight of silver chloride by precipitation with the purest radium sample that she had. The radium chloride weighed nearly one centigram in each determination. It was then added to some silver nitrate solution that formed a deposit of silver chloride. The resulting deposit was accurately weighed. The mean atomic weight of the radium was found to be 225 by this method.

As radium chloride is hygroscopic (i.e., absorbs moisture), therefore, the weighing had to be rapidly performed. The hydrated chloride obtained by crystallization was heated to drive off any water that was present. When the weight was found to be constant, it was raised to double the temperature. The weight still remaining the same proved it to be absolutely free of water. The precipitated silver chloride was radioactive and luminous, but there was no appreciable quantity



of radium in it. The resulting silver was found to weigh exactly what it should were the chloride pure. Runge and Precht determined the atomic weight of radium from considerations based upon the spectrum of radium, and found it to be 257.8. Neither of these determinations agreed with what was expected from the periodic law of the elements. The law states that elements of the same general properties have their atomic weight so related that, if any three elements of a group are taken in regular ascending order, the atomic weight of the middle one is half the sum of the other two. Thus, as radium is believed to belong to the barium group, its atomic weight should be around 234. <sup>(5)</sup>

5) Radium: and other Radio-active Elements by **Leonard A. Levey & Herbert G. Willis**, 1907, p. 75 - 76.

The above-sited reference is what leads me to believe that "radium" does not exist. What is being called radium could very well be in reality a double salt of U234/U235 and barium. The more "radium salt" is fractionalized the greater the concentrated the U234 and U235 becomes! Therefore, the material becomes more and more active! This makes sense because the half-lives of U234 and U235 are much shorter than its associated U238. The activity increases as the amount of barium decreases. Fractionalize the radium salt still further and it is reasonable to deduce that we will end up with a high concentration of U234 and U235. This U234 and U235 generates radon gas in their decay chains. The misinterpretation of the nature of the substance called radium, in my opinion, has occurred because of the method that was used to weigh it. It is a fact that radium can not be completely separated from its associated barium. If "radium" can not be separated from the barium then how can we accurately determine its weight? Why hasn't anyone today taken notice that what is being isolated along side barium could in fact be U234, U235 or a combination of the two? Or have they?

### **Over-unity in Nature**

Madame Curie-Joliot and M. Joliot made the very striking observation that the radiation from beryllium and from boron was able to eject protons with considerable velocities from matter containing hydrogen. In their experiments the radiation from beryllium was passed through a thin window into an ionization vessel containing air at room pressure. When paraffin wax, or other matter containing hydrogen, was placed in front of the window, the ionization in the vessel was increased, in some cases as much as doubled. The effect appeared to be due to the ejection of protons, and from further experiment they showed that the protons had ranges in air up to about 26 cm., corresponding to a velocity of nearly  $3 \times 10^9$  cm per sec. They suggested that energy was transferred from the beryllium radiation to the proton by a process similar to the Compton effect with electrons, and they estimated that the beryllium radiation had quantum energy of about  $50 \times 10^6$  electron volts (50MeV). The range of the protons ejected by the boron radiation was estimated to be about 8 cm. in air, giving – on a Compton process of energy – of about  $35 \times 10^6$  electron volts (35MeV) for the effective quantum.

It is difficult to account for the production of a quantum of 50 MeV from the interaction of a beryllium nucleus and  $\alpha$ -particle of kinetic energy of  $5 \times 10^6$  electron volts (5MeV). <sup>(6)</sup>

6) "The Existence of a Neutron" by **J. Chadwick, F.R.S. Proc. Roy. Soc., A**, 136, p. 693 (Received May 10, 1932)

The above observations prove that there are at least two over-unity reactions in the natural World. There is clearly up to ten times more energy coming out than what is going into the beryllium/alpha reaction. I suspect that there are many more combinations that are yet to be discovered. Le Bon and Moray were pioneers in this line of research. With the equipment that we have today and with the knowledge of the various isotopes I predict that their discovery is near.



## Clean Nuclear Reactors Are Possible

Mother Nature offers us a clean nuclear process to supply us with energy. My reasoning is based upon her process that leaves behind a clean, non-toxic ash. You have seen it in children's balloons at birthday parties. The inert gas that I am referring to here is called "helium". This is the only ash that is left behind by Nature's process. There are no deadly radio toxins like the ones found in the commercial reactor. It makes all the difference in creation how the reaction is carried out and for what purpose.

Spent nuclear plant material is bad stuff. When atoms are "split" like they are in a conventional nuclear reactor the course of nature is diverted and there are detrimental effects. My proposed processes could allow nature to go its own way. We would not be splitting the atoms like is done in conventional nuclear power plants and creating deadly nuclear by-products.

Not too many people now this but Virginia Beach is highly radioactive. Its sand contains monazite. This is a thorium ore. We do not need to worry about the natural stuff. Studies have shown that it is actually a benefit to our health.

The commercial nuclear reactor releases high concentrations of toxic radioisotopes. This is a direct result of the reaction of **URANIUM-235** haphazardly splitting into atomic fragments like glass. It is highly probable that we can design reactors that will release only pure electrical particles instead of the toxic radioisotopes that are created by stray fission fragmentation. Why not build clean reactors that do not generate these stray fragments? Nature accomplishes this everyday! Learning how nature accomplishes this feat will open the doorway to a safe reactor design. My extraction process could be part of the answer. Excess neutron generation could be eliminated. If we study the processes found in the natural world more closely we might obtain the knowledge to build a clean atomic reactor.

### Fundamental Atomic Guideline

1. Alpha bombardment of any element with atomic numbers from **1** through **15** will generate a new and stable element. One excess neutron will result from the reaction.
2. Neutron bombardment of any stable element from **16** and above will generate a new and unstable element through the capture of neutrons. One or more neutrons are released from the reaction. The targeted element will gain the weight of the absorbed neutrons. 
3. Neutron bombardment of an unstable element generates one helium-4 atom from each reaction. The atomic weight of the targeted element loses the weight of one helium-4 atom as a result of the reaction.
4. From these facts, it is not too hard to figure out that it is the beryllium, boron, or carbon control rods in a commercial nuclear reactor that are actually what supplies the initial neutron kick to begin the "fission reaction". The "moderator" provides high-speed protons to boost neutron production where there is not a high enough concentration of U235 to supply the required alpha particles. Scientists of yesteryear had been on the correct path. It was atomic bomb era mentality that took us off the narrow path. This was all in the name of "national security". It will only be when these facts resurface that advances will be made in the way we obtain energy.

## BOOK CONCLUSION

Funding has not permitted me to build a device that can power a home or electric car. However, my prototypes have proven beyond doubt that with the proper funding this can be accomplished. It is my hope, through the publication of my findings, that funding will be forthcoming. At this point in time, it is most important to me that I receive credit for my work and that my research discoveries do not fall on deaf ears.

Public tests are performed as necessary to validate the technologies. These demonstrations are deemed as research and development tests only. No power claims are expressed or implied at this time.

For almost fifteen years now I have carried out many experiments. The fruits of this research are ripening. Many fruits are within grasp but they are not yet quite ripe for the picking. The intent of revealing my progress to the World is to insure that this work is not done in vain. Through my writings I have attempted to explain the many facets of "radiant energy" and how it is possible to draw useable power from it. If radiant energy can be given to the World then humankind will have the potential to reach heights not yet dreamed or conceived. Today, I freely give to you the results of my life's work. Together we can reclaim our independence!

## ADDITIONAL REFERENCES

**The Evolution of Matter**  
by **Gustave Le Bon** 1907

**The Evolution of Forces**  
by **Gustave Le Bon** 1908

**Radiations from Radioactive Substances**  
by **Sir E. Rutherford, J. Chadwick, and C. D. Ellis** 1930, revised 1951

**The Interpretation of Radium and the Structure of the Atom** by **Frederick Soddy, M.A., F.R.S.** 1920

Annual Report of the Smithsonian Institution (1899) – **An Experimental Study of Radio-Active Substances** by **Henry Carrington Bolton** - see postscript **p. 162**

United States Patent No. 1,655,184 **Otto Haun** – Jan 3, 1928

United States Patent No. 1,644,370 **A. Gaschler** – Oct. 3, 1927



Fig. 1.

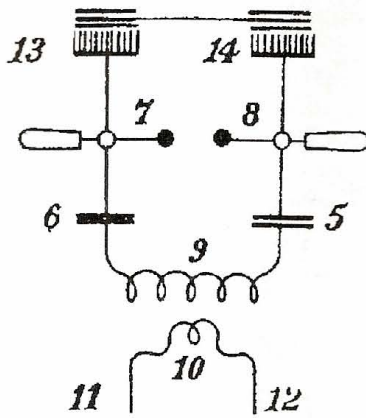

Fig. 2.

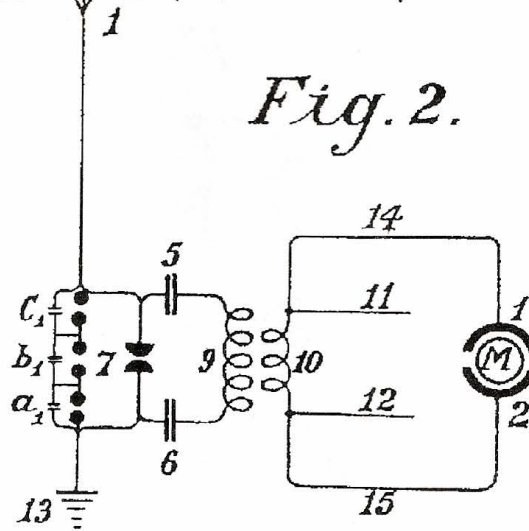

Fig. 3.

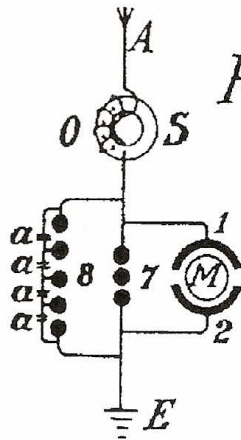

Fig. 4.

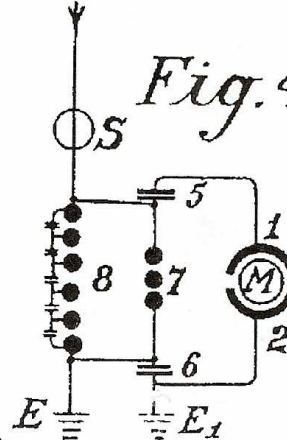

Fig. 5.

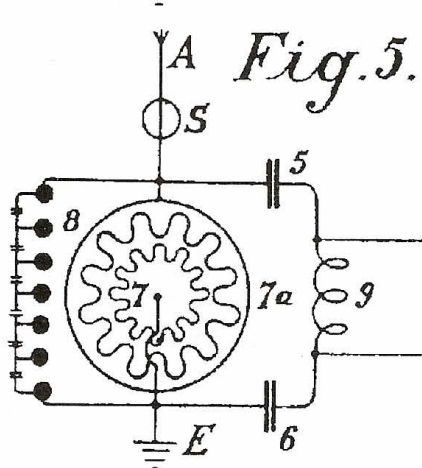
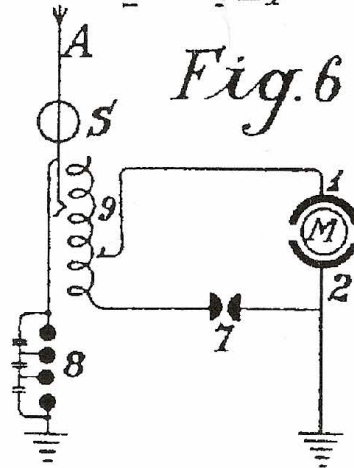

Fig. 6.



I g v e g l o r

Hermann Plauson

by Knight Bros  
attorneys

CONVERSION OF ATMOSPHERIC ELECTRIC ENERGY

Filed Jan. 13, 1921

12 Sheets-Sheet 3

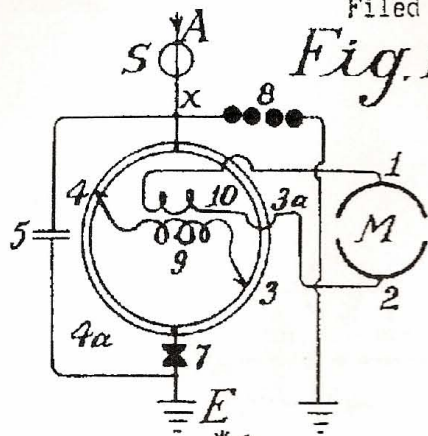

Fig. 14.

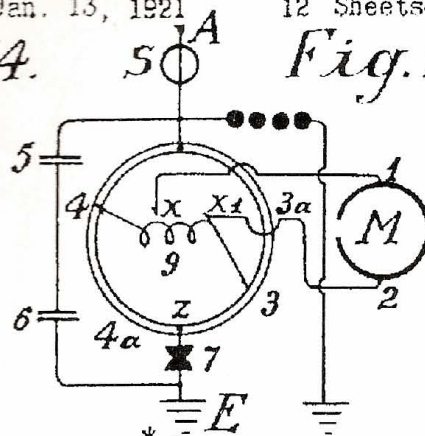

Fig. 15.

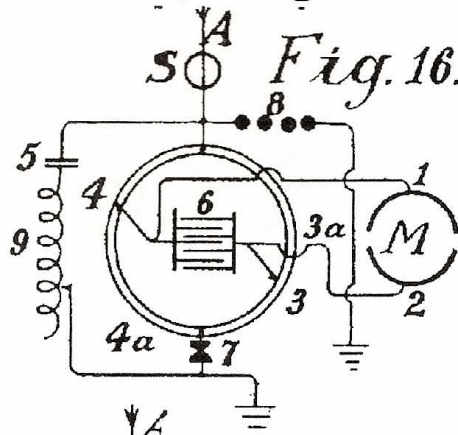

Fig. 16.

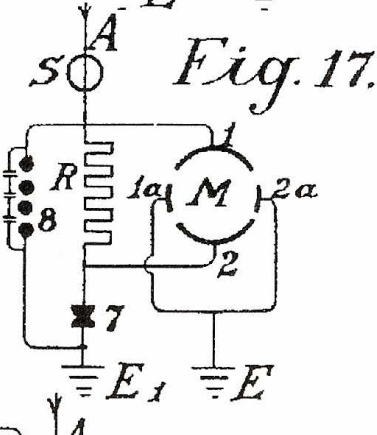

Fig. 17.

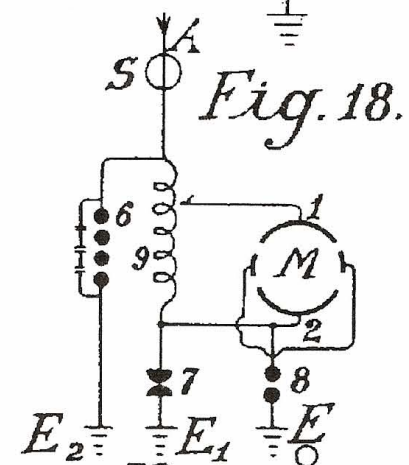

Fig. 18.

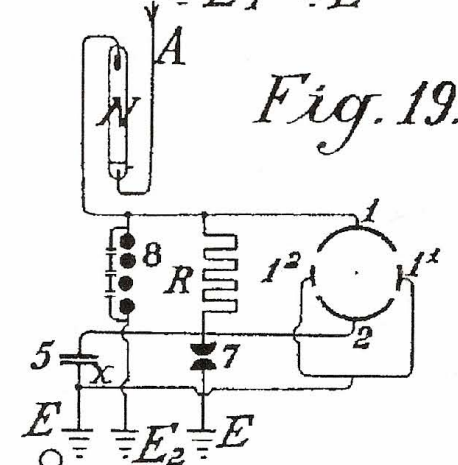

Fig. 19.

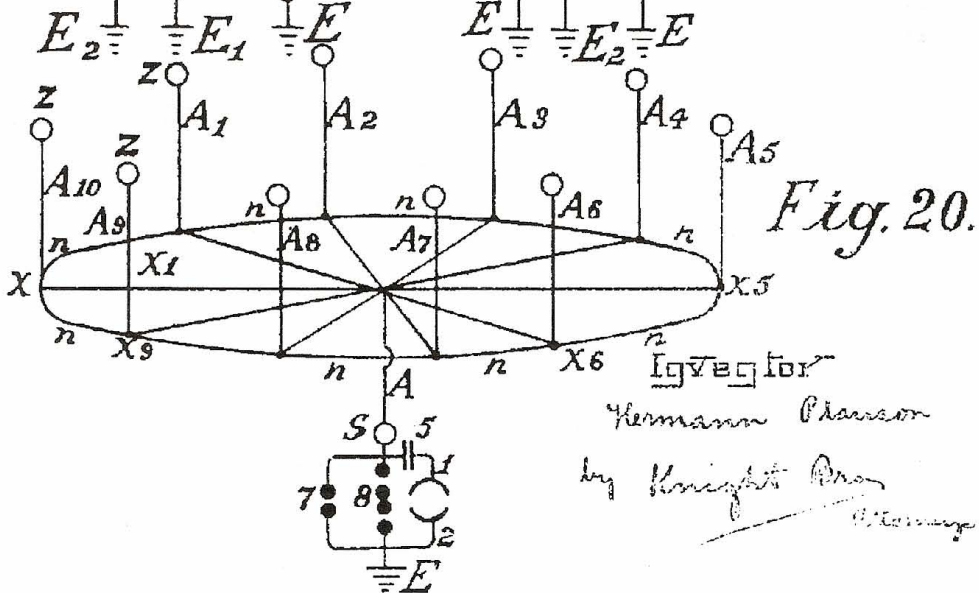

Fig. 20.

Inventor  
 Hermann Plauson  
 by Knight Bros  
 Attorneys



H. PLAUSON

CONVERSION OF ATMOSPHERIC ELECTRIC ENERGY

Filed Jan. 13, 1921

12 Sheets-Sheet 4

Fig. 22.

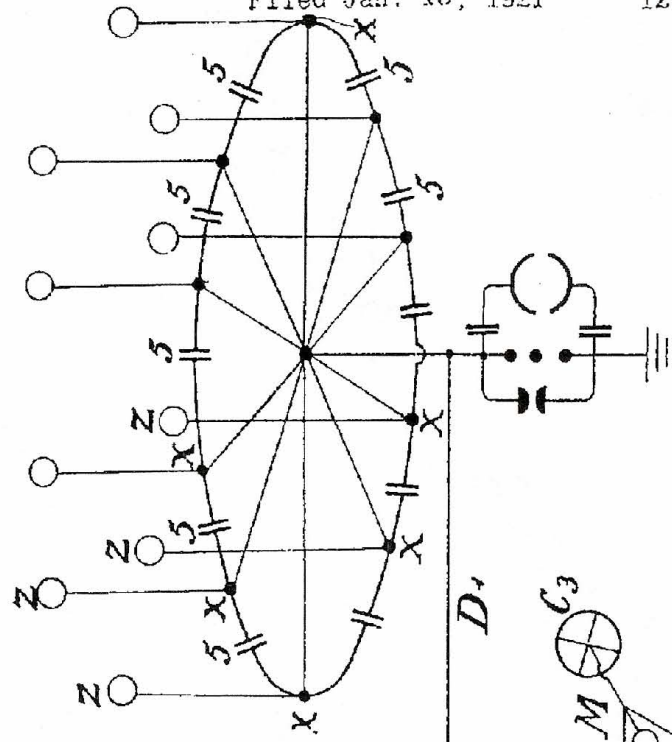

Fig. 21.

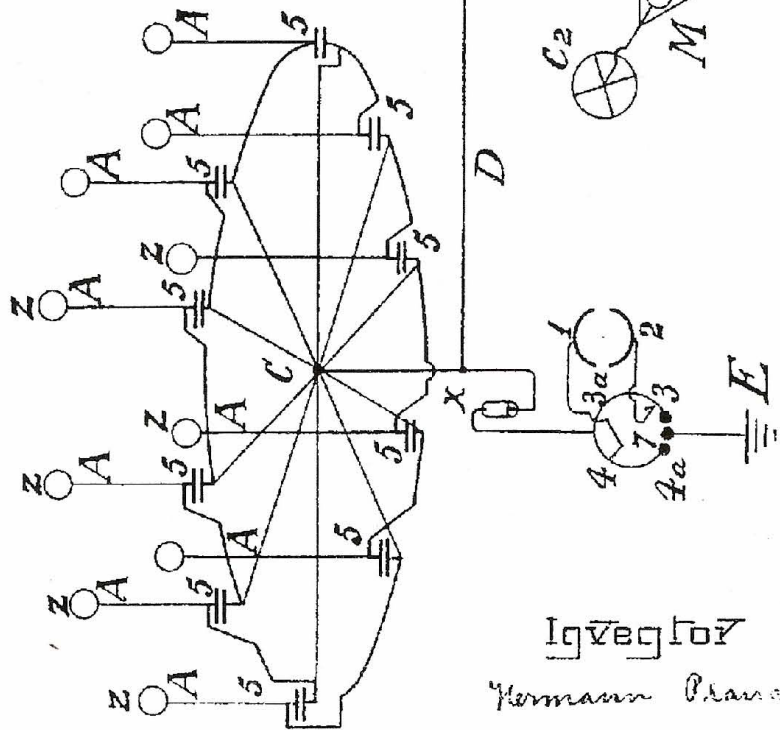
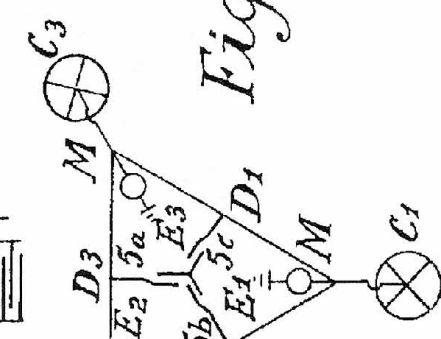

Fig. 23.



Inverted  
 Hermann Plauson  
 by Knight B  
 Attorney

transforming the carbon and oxygen into CO<sub>2</sub>. Pretty much the same fundamental principle must occur when radon gas is released from its heavy metal prison. The reactant in this later case is a neutron from a previous radon gas emission. Radon reacts with a metal, losing a neutron to it. When this occurs, the radon becomes highly unstable, emitting alpha particles and rapidly transforming this gas into stable lead. From this reaction it is clear that radon is not as inert as we were lead to believe. In fact, I say that radon is at the very foundation of all nuclear reactions.

Since the discovery of radium by Madame Curie, the fundamental method of its extraction has not changed. The process utilizes the same methods that were instituted by Madame Curie and M. Debiere. Radioactive ores are first treated with a warm solution of hydrochloric acid that dissolves the metals. The addition of sulfuric acid precipitates the insoluble barite's that are always present, carrying along with them all the radium as barium sulfate. It is necessary that barium is present in the process. If the solution does not contain a sufficient quantity, then some barium has to be added. It is said that the barium acts as a "carrier" to the radium. Can there be any other explanation? It never made much sense to me why the radium would not precipitate out without the barium. I simply could not accept the notion that it only served as the carrier. The answer to this problem becomes relatively simple if you let Nature be your teacher. Forget what the textbooks tell you. We know from her lessons that radiation can be induced into non-radioactive elements, do we not? Could it be then, that something in the separated hydrochloric solution is transforming the barium into what we call radium? Ala-ka-zam, low and behold, there sure is, it is called URANIUM-235.

### **Nu Radium Formula**

Radium may be synthetically manufactured by fusing dry uranium nitrate mixed with about 0.5% of dry barium nitrate. This is done in the heat of an electric arc. The mass is then treated with nitric acid, water and sulfuric acid, successively. Radioactive barium sulfate, possessing all the physical properties of the "element" discovered by Madame Curie, is obtained through this formula. This material will emit ultra-violet rays, x-rays, excite phosphor screens and cause air to conduct electricity. The chloride and the carbonate of radium may also be created by using uranium chloride or uranium carbonate respectively and will display the same properties.

Uranium nitrate typically contains about 0.72 per cent **U235**. The barium reacts with the U235 creating pure radium. We now know for certain that the barium is not just a simple carrier as has been believed. Best results are obtained when 0.72 per cent barium is added, making it equal or less than the amount of U235 contained in the nitrate. If sulfuric acid is added after the reaction takes place, then radium sulfate is precipitated. This material can now be filtered for removal from the solution. A seemingly synthetically created radium salt results when barium forms a double salt with the U235 atom. It can not come into being otherwise. **All other radioisotopes might be called into existence in the presence of U235.** There are other processes involved but this will be explored at a future date. Radioisotopes created by ultra-chemical processes could have far reaching ramifications, if and when it is taken under the wing of mainstream science. Radioisotopes could be made to order literally in a jar. My findings appear to indicate that all radioactive substances originate from the U235 atom. Where did the U235 atom originate? I can only speculate at this point that it is created when a cosmic ray hits a stable U238 atom head-on. If my conclusions turn out to be correct, then the energy stored in radiant matter is a product of an external cosmic force and an internal force without contradiction.



June 9, 1925.

1,540,998

H. PLAUSON

CONVERSION OF ATMOSPHERIC ELECTRIC ENERGY

Filed Jan. 13, 1921

12 Sheets-Sheet 5

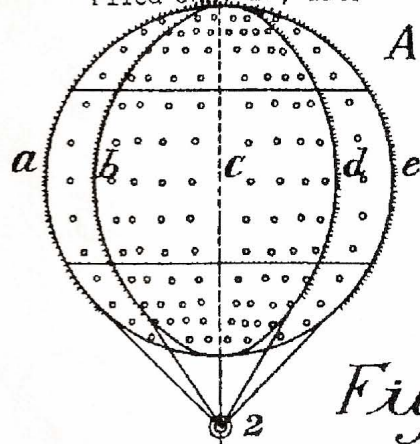
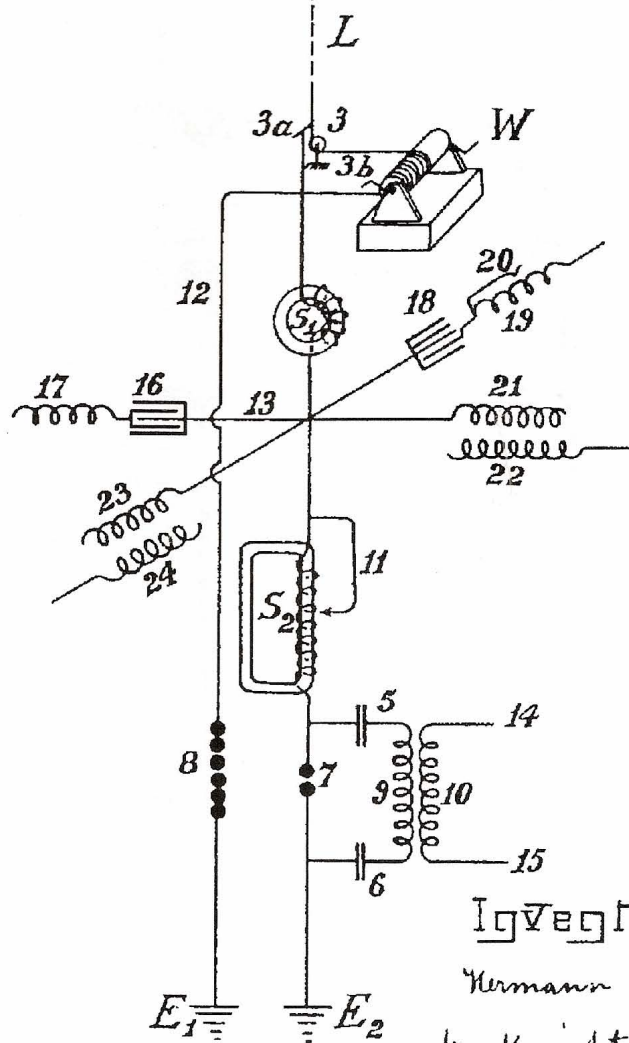

Fig. 24.



*Igvegor*

Hermann Plauson

by Knight Bros

Attorneys

H. PLAUSON

CONVERSION OF ATMOSPHERIC ELECTRIC ENERGY

Filed Jan. 13, 1921

12 Sheets-Sheet 6

Fig. 25.

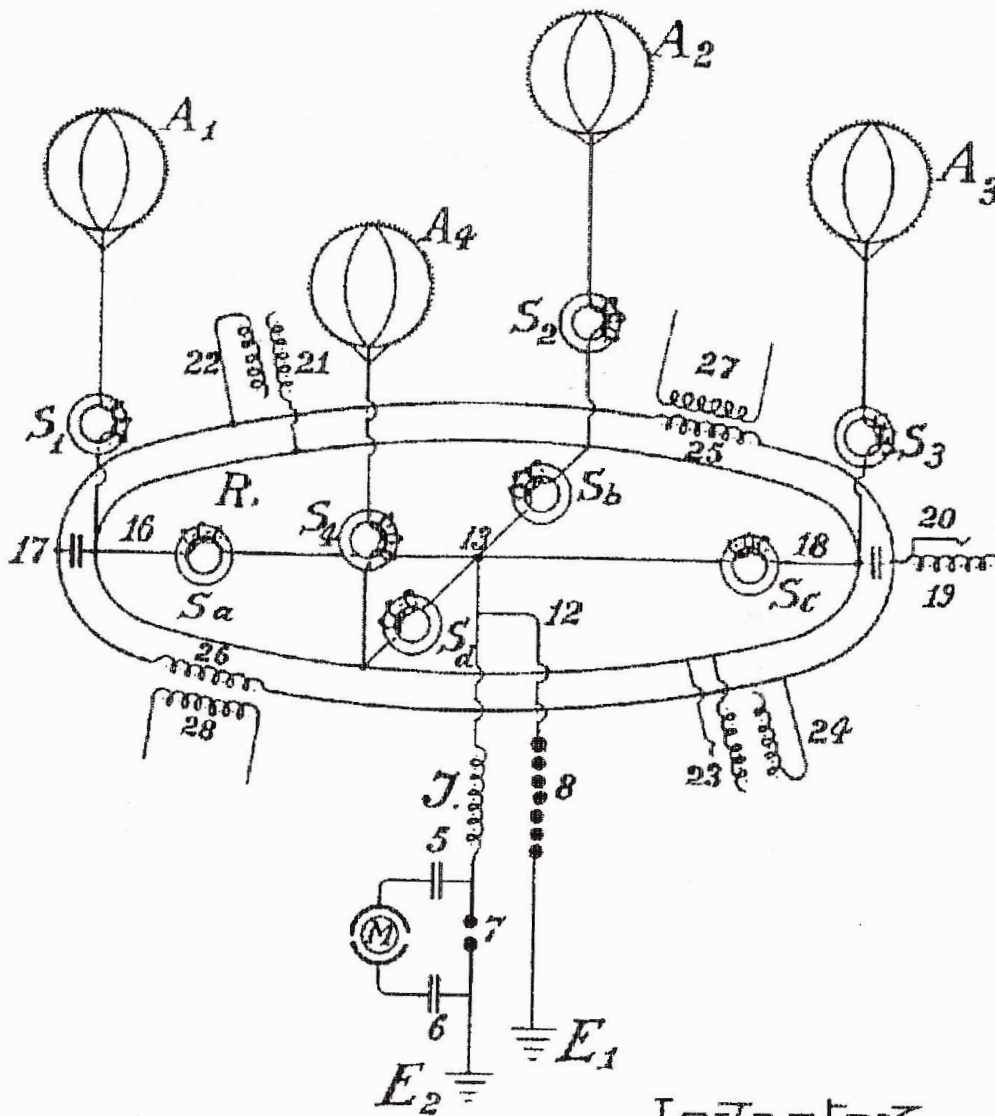

Iqvegtor

Hermann Plauson

by Knight Bros  
attorneys



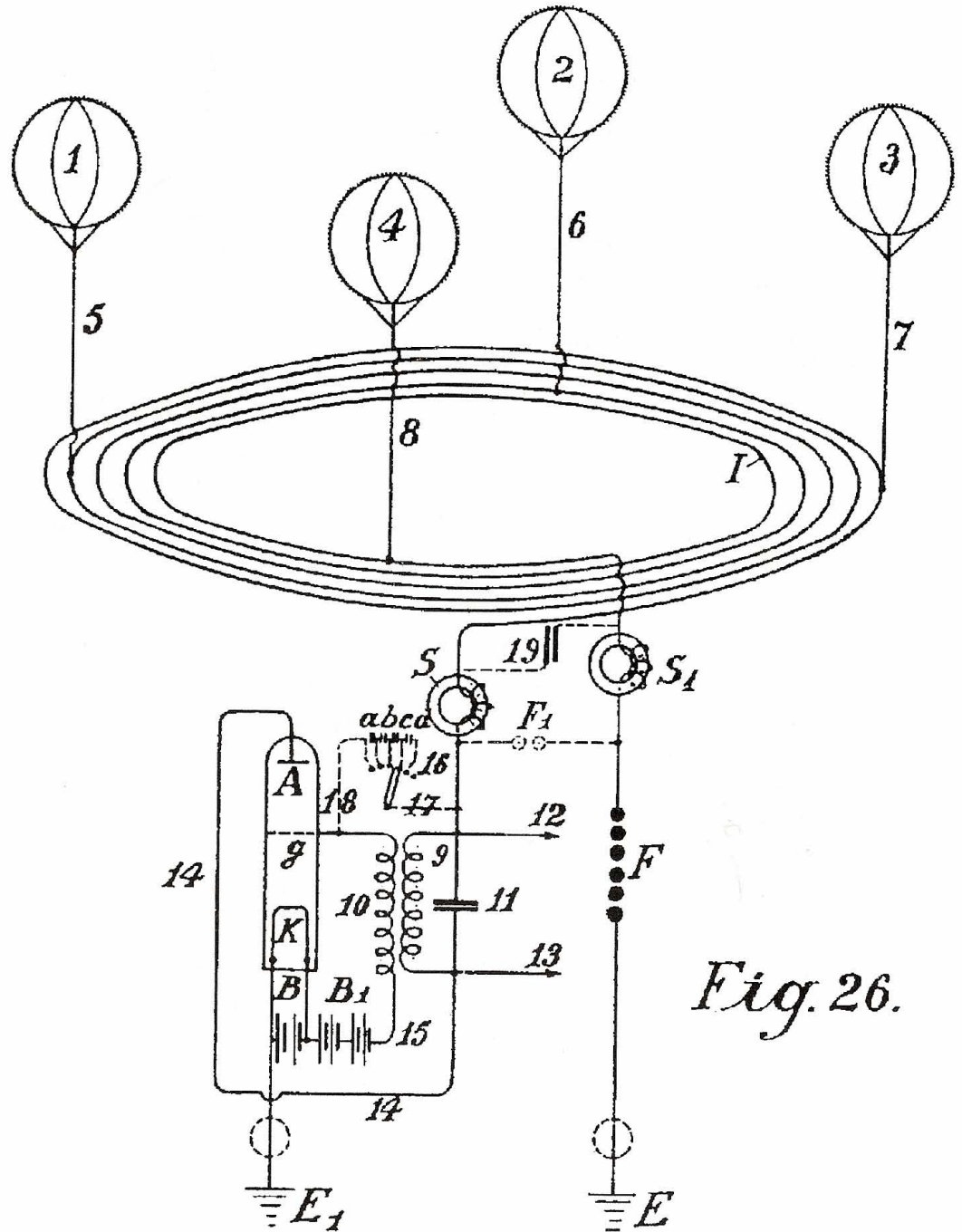

Fig. 26.

IGVeglor

Hermann Plauson

by Knight Bros  
Attorneys





H. PLAUSON

CONVERSION OF ATMOSPHERIC ELECTRIC ENERGY

Filed Jan. 13, 1921

12 Sheets-Sheet 9

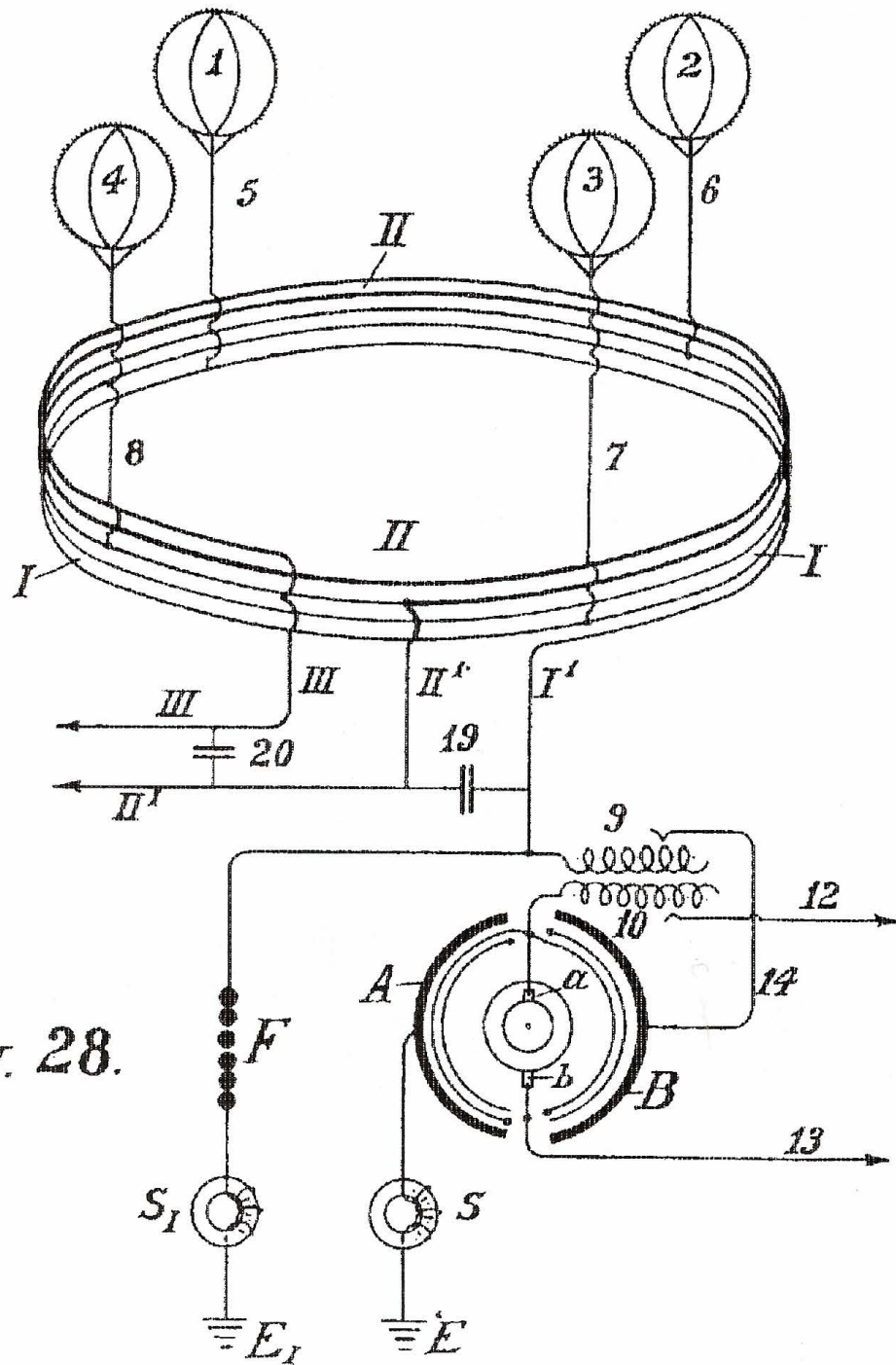

Fig. 28.

Iqvegtor

Hermann Plauson

by  
Knight & Ben  
attorneys

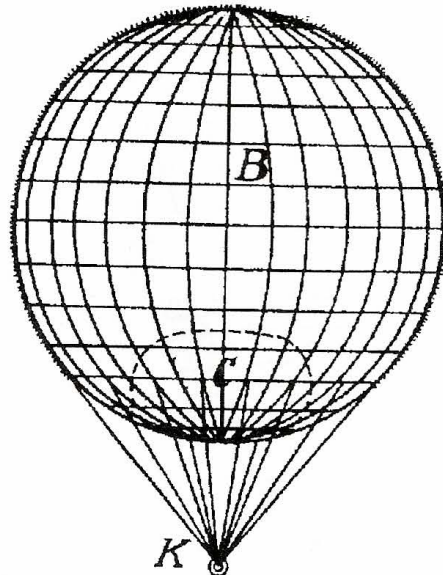

Fig. 29.

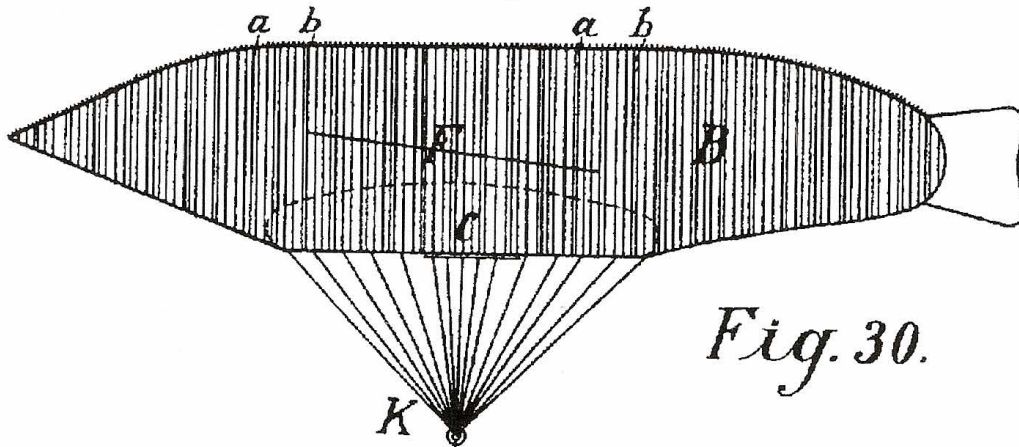
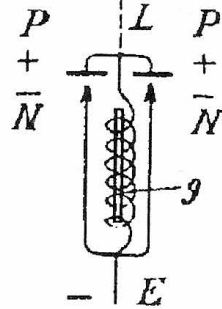
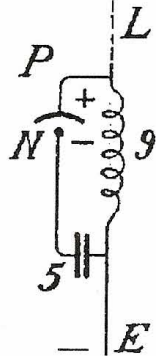

Fig. 30.



Изобретено  
Германом Плаусоном

by  
Knight Bros  
Attorneys



CONVERSION OF ATMOSPHERIC ELECTRIC ENERGY

Filed Jan 13 1921 12 Sheets-Sheet 11

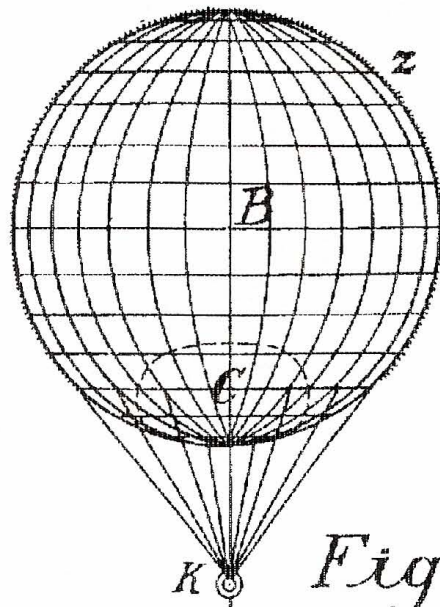

Fig. 31.

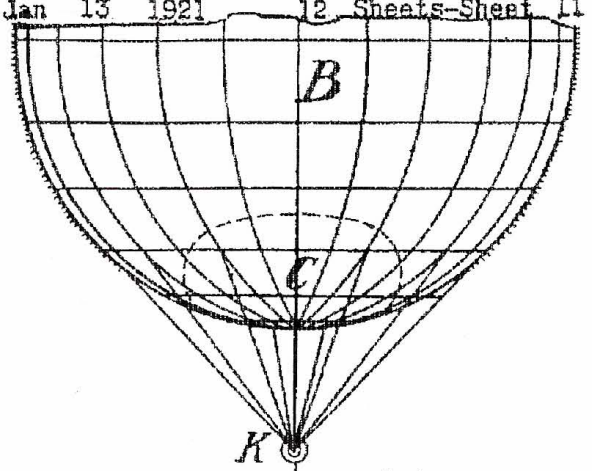
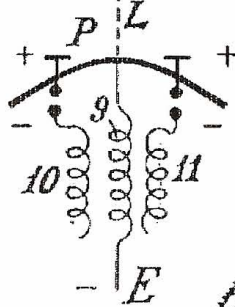

Fig. 32.

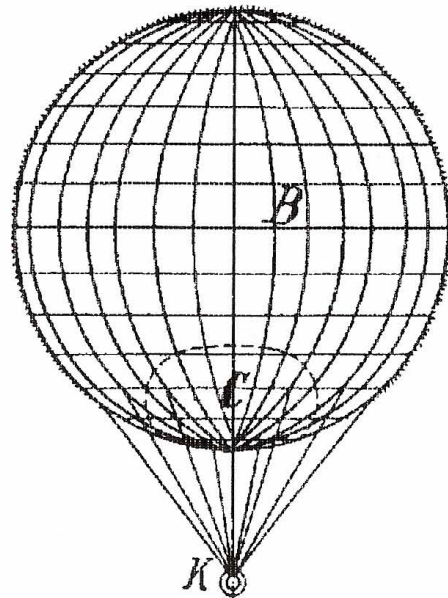
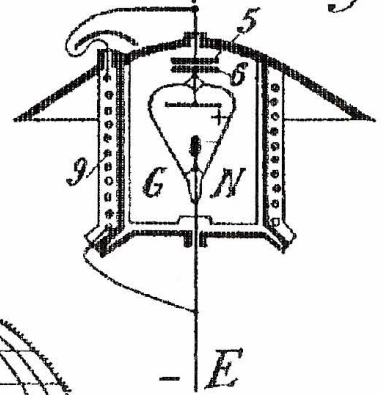
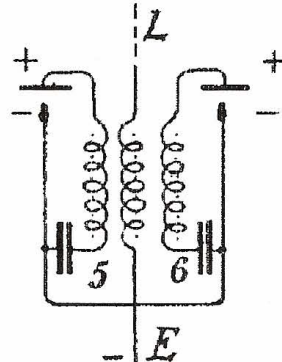

Fig. 33.



IgVogFor  
 Hermann Plauson  
 by Knight Bros  
 Attorneys

CONVERSION OF ATMOSPHERIC ELECTRIC ENERGY

Filed Jan. 13, 1921

12 Sheets-Sheet 12

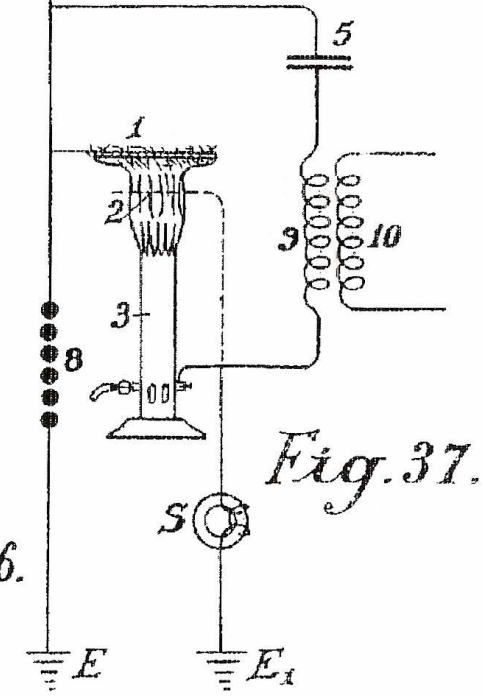
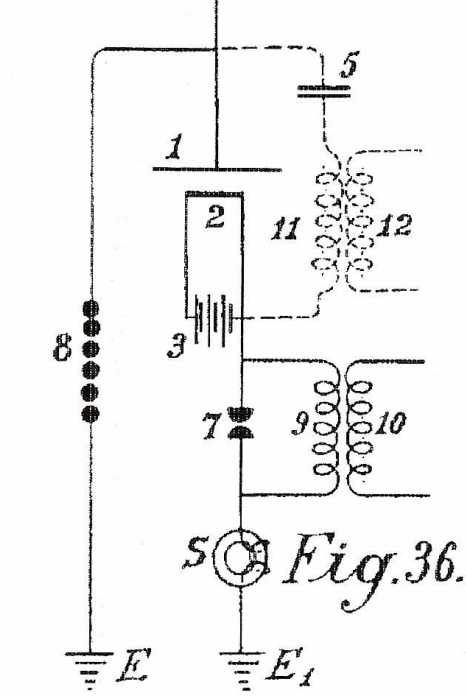
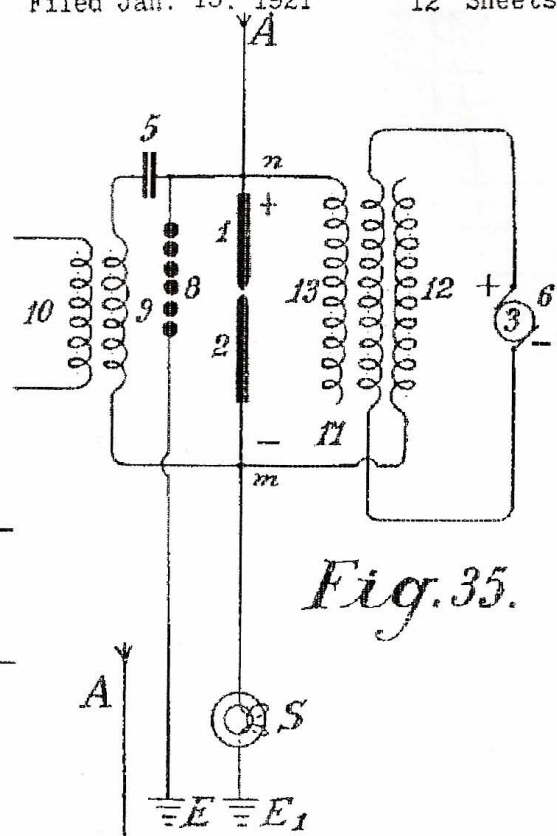
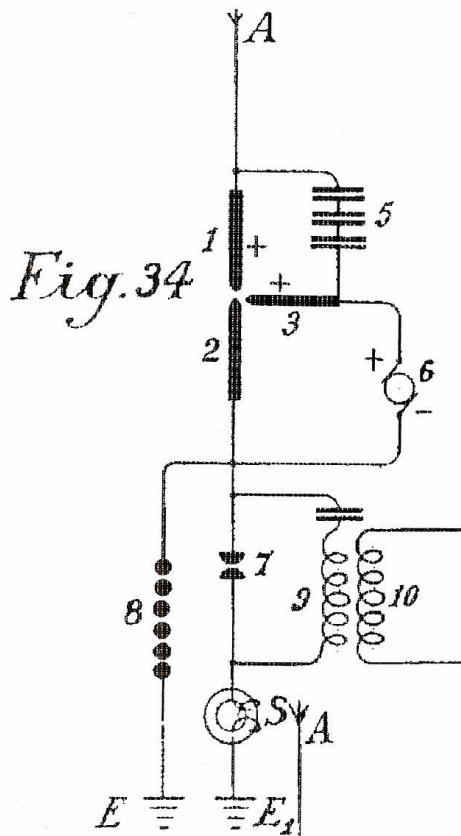

Inventor

Herman Plauson

By *Knight & O'Connell*  
Attorneys



# UNITED STATES PATENT OFFICE.

HERMANN PLAUSON, OF HAMBURG, GERMANY.

CONVERSION OF ATMOSPHERIC ELECTRIC ENERGY.

Application filed January 13, 1921. Serial No. 437,107.

*To all whom it may concern:*

Be it known that I, HERMANN PLAUSON, Esthonian subject, residing in Hamburg, Germany, have invented certain new and useful Improvements in the Conversion of Atmospheric Electric Energy, of which the following is a specification.

Methods of obtaining atmospheric electricity by means of metallic nettings set with spikes which are held by means of ordinary or anchored kite balloons made of fabrics and filled with hydrogen, are in theory already known. Atmospheric electricity obtained in this way has been suggested to be used in the form of direct current for the charging of accumulators. This knowledge however is at present only theoretical as the conversion in practice has hitherto been a failure. No means are known of protecting the apparatus from destruction by lightning. The balloons used for collecting the charge must also be made of very large size in order to be able to support the weight of the metallic netting and the heavy cable connections.

Instead of using heavy metallic netting as collectors attached to single air balloons of non-conducting materials which are liable to be torn and are permeable to the gas, it is proposed to use metallic balloon collectors which have the following important advantages—

(a) The metallic cases are impenetrable to helium and hydrogen; they also represent large metallic weather-proof collecting surfaces.

(b) Radio active means and the like may be easily applied internally or externally; whereby the ionization is considerably increased and therewith also the quantity of atmospheric electricity capable of being collected.

(c) Such balloon collectors of light metal do not require to be of large size as they have to carry only their own moderate weight, and that of the conducting cable or wire.

(d) The entire system therefore offers little surface for the action of storm and wind and is resistant and stable.

(e) Each balloon can be easily raised and lowered by means of a winch so that all repairs, recharging and the like can be carried out without danger during the operation.

It is further proposed to use a collecting aerial network of several separate collectors spread out in the air above the earth, which collectors are interconnected by electrical conductors.

According to this invention charges of atmospheric electricity are not directly converted into mechanical energy, and this forms the main difference from previous inventions, but the static electricity which runs to earth through aerial conductors in the form of direct current of very high voltage and low current strength is converted into electro-dynamic energy in the form of high frequency vibrations. Many advantages are thereby obtained and all disadvantages avoided.

The very high voltage of static electricity of a low current strength can be converted by this invention to voltages more suitable for technical purposes and of greater current strength. By the use of closed oscillatory circuits it is possible to obtain electromagnetic waves of various amplitude and thereby to increase the degree of resonance of such current. Such resonance allows various values of inductance to be chosen whereby again the governing of the starting and stopping of machines driven thereby by simply tuning the resonance between coils of the machine and the transformer circuit forming the resonance can easily be obtained. Further, such currents have the property of being directly available for various uses, even without employing them for driving motors, of which there may be particularly mentioned, lighting, production of heat and use in electro-chemistry.

Further, with such currents a series of apparatus may be fed without direct current supply through conductors and also the electro-magnetic high frequency currents may be converted by means of special motors adapted for electro-magnetic oscillations into mechanical energy, or finally converted by special machines into alternating current of low frequency or even into direct current of high potential.

The invention is more particularly described with reference to the accompanying diagrams in which:—

Figure 1 is an explanatory figure.

Figure 2 is a diagrammatic view of the simplest form.



Figure 3 shows a method of converting atmospheric electrical energy for use with motors.

Figure 4 is a diagram showing the use of protective means.

Figure 5 is a diagram of an arrangement for converting large current strengths.

Figure 6 is a diagram of an arrangement including controlling means.

Figure 7 shows means whereby the spark gap length can be adjusted.

Figure 8 shows a unipolar connection for the motor.

Figure 9 shows a weak coupled system suitable for use with small power motors.

Figures 10, 11 and 12 show modified arrangements.

Figure 13 shows a form of inductive coupling for the motor circuit.

Figure 14 is a modified form of Figure 13 with inductive coupling.

Figure 15 is an arrangement with non-inductive motor.

Figure 16 is an arrangement with coupling by condenser.

Figures 17, 18 and 19 are diagrams of further modifications.

Figure 20 shows a simple form in which the aerial network is combined with special collectors.

Figure 21 shows diagrammatically an arrangement suitable for collecting large quantities of energy.

Figure 22 is a modified arrangement having two rings of collectors.

Figure 23 shows the connections for three rings of collectors.

Figure 24 shows a collecting balloon and diagram of its connection of condenser batteries.

Figures 25 and 26 show modified collector balloon arrangements.

Figure 27 shows a second method of connecting conductor for the balloon aeri-als.

Figure 28 shows an auto-transformer method of connection.

Figure 29 shows the simplest form of construction with incandescent cathode.

Figure 30 shows a form with cigar shaped balloon.

Figure 31 is a modified arrangement.

Figure 32 shows a form with cathode and electrode enclosed in a vacuum chamber.

Figure 33 is a modified form of Figure 32.

Figure 34 shows an arc light collector.

Figure 35 shows such an arrangement for alternating current.

Figure 36 shows an incandescent collector with Nernst lamp.

Figure 37 shows a form with a gas flame.

Figure 1 illustrates a simple diagram for converting static electricity into dynamic energy of a high number of oscillations. For the sake of clearness in the drawings an influence machine is assumed to be employed

and not an aerial antenna. 13 and 14 are combs for collecting the static electricity of the influence machine. 7 and 8 are spark discharging electrodes, 6 and 5 condensers, 9 an inductive primary coil, 10 secondary coil, 11 and 12 ends of conductors of the secondary coil 10. When the disc of the static influence machine is rotated by mechanical means, the combs collect the electric charges one the positive and the other the negative, and charge the condensers 5 and 6 until such a high potential is formed across the spark gap 7—8, that the spark gap is jumped. As the spark gap 7—8 forms a closed circuit with condensers 6 and 5, and inductive resistance 9, as is well known, waves of high frequency electromagnetic oscillations will pass in this circuit.

The high frequency of the oscillations produced in the primary circuit induces waves of the same periodicity in the secondary circuit. Thus in the primary circuit electromagnetic oscillations are formed by the passage of the spark over the spark gap and these waves are maintained by fresh charges of static electricity.

By suitably selecting the ratio between the number of the coils in the primary and secondary circuits with regard to a correct application of the co-efficients of resonance (capacity, inductance, and resistance) the high voltage of the primary circuit may be suitably converted into low voltage and high current strength.

When the oscillatory discharges in the primary circuit becomes weaker or entirely cease, the condensers are charged again by the static electricity until the accumulated charge again breaks down the spark gap. All this is repeated as long as electricity is produced by the static machine by employing mechanical energy.

An elementary form of the invention is shown in Figure 2 in which two spark gaps in parallel are used one of which may be termed the working gap 7 in Figure 2, whilst the second serves as a safety device for excess voltage and consists of a larger number of spark gaps than the working section, which gaps are arranged in series and are bridged by very small capacities as is illustrated in  $a_1, b_1, c_1$ , Figure 2 which allow of uniform sparking in the safety section.

In Figure 2 A is the aerial antenna for collecting charges of atmospheric electricity. 13 is the earth connection of the second part of the spark gap, 5 and 6 are condensers, 9 a primary coil. Now when through the aerial A the positive atmospheric electricity seeks to combine with the negative charge to earth, this is prevented by (the air gap between) the spark gaps. The resistance of the spark gap 7 is, as shown in the drawings, lower than that of the other safety section which consists of three spark gaps connected in



series, and consequently a three times greater air resistance is offered by the latter.

So long therefore, as the resistance of the spark gap 7 is not overloaded, so that the other spark gaps have an equal resistance with it the discharges take place only over spark gap 7. Should however the voltage be increased by any influences so that it might be dangerous for charging the condensers 5 and 6 or for the coil insulation 9 and 10 in consequence of break down, by a correct regulation of this spark gap the second spark gap can discharge free from inductive effects direct to earth without endangering the machine.

Without this second spark gap, arranged in parallel having a higher resistance than the working spark gap it is impossible to collect and render available large quantities of electrical energy.

The action of this closed oscillation circuit consisting of spark gap 7, two condensers 5 and 6, primary coil 9, and also secondary coil 10 is exactly the same as the one described in Figure 1 with the arrangement of the static induction machine with the only difference that here the second spark gap is provided. The electromagnetic high frequency alternating current obtained can be tapped off from the conductors 11 and 12 for lighting and heating purposes. Special kinds of motors adapted for working with these peculiar electrical charges may be connected at 14 and 15 which can work with static electricity charges or with high frequency oscillations.

In addition to the use of spark gaps in parallel a second measure of security is also necessary for taking off the current. This precaution consists according to this invention, in the introduction of and method of connecting certain protective electromagnets or choking coils in the aerial circuit as shown by S in Figure 3.

A single electromagnet only having a core of the thinnest possible separate laminations is connected with the aerial.

In the case of high voltages in the aerial network or at places where there are frequent thunder storms, several such magnets may however be connected in series.

In the case of large units or plants several electromagnets can be employed in parallel or in series parallel.

The windings of these electromagnets may be simply connected in series with the aeriels. In this case the winding preferably consists of several thin parallel wires, which make up together, the necessary section.

The winding may be made of primary and secondary windings in the form of a transformer. The primary winding will be then connected in series with the aerial network, and the secondary winding more or less short-circuited over a regulating resist-

ance or an induction coil. In the latter case it is possible to regulate to a certain extent the effect of the choking coils. In the further description of the connecting and constructional diagrams the aerial electromagnet choke coil is indicated by a simple ring S.

Figure 3 shows the simplest way of converting atmospheric electricity into electromagnetic wave energy by the use of special motors adapted for high oscillatory currents or static charges of electrical energy. Recent improvements in motors for working with static charges and motors working by resonance, that is to say, having groups of tuned electromagnetic cooperating circuits render this possible but such do not form part of the present invention.

A motor adapted to operate with static charges will for the sake of simplicity be diagrammatically indicated by two semi-circles 1 and 2 and the rotor of the motor by a ring M. (Figure 3.) A is a vertical aerial or aerial network. S the safety choke or electromagnet with coil O as may be seen is connected with the aerial A. Adjacent the electromagnet S the aerial conductor is divided into three circuits, the circuit 8 giving the safety spark gap, the circuit 7 with the working spark gap, and then a circuit including the stator terminal 1, the rotor and stator terminal 2 at which a connection is made to the earth wire. The two spark gaps are also connected metallically with the earth wire. The method of working these diagrams is as follows:

The positive atmospheric electric charge collected tends to combine with the negative electricity (or earth electricity) connected with the earth wire. It travels along the aerial A through the electromagnet S without being checked as it flows in the same direction as the direct current. Further, its progress is arrested by two sparks gaps placed in the way and the stator condenser surfaces. The stator condenser surfaces are charged until the charge is greater than the resistance of the spark gap 7, whereupon a spark springs over the spark gap 7 and an oscillatory charge is obtained as by means of the motor M, stator surfaces 1 and 2, and spark gap 7, a closed oscillation circuit is obtained for producing the electromagnetic oscillations. The motor here forms the capacity and the necessary inductance and resistance, which, as is well known, are necessary for converting static electricity into electromagnetic wave energy.

The discharges formed are converted into mechanical energy in special motors and can not reach the aerial network by reason of the electromagnet or choke. If, however, when a spark springs over the spark gap 7 a greater quantity of atmospheric electricity tends to flow to earth, a counter voltage is



induced in the electromagnet, which is greater the more rapidly and strongly the flow of current direct to the earth is. By the formation of this opposing voltage a sufficiently high resistance is offered to the flow of atmospheric electricity direct to earth to prevent a short circuit with the earth.

The circuit containing spark gap 8 having a different wave length which is not in resonance with the natural frequency of the motor, does not endanger the motor and serves as security against excess voltage, which, as practical experiments have shown, may still arise in certain cases, but can be conducted direct to earth through this spark gap.

In the diagram illustrated in Figure 4 the spark gap 7 is shunted across condensers 5 and 6 from the motor M. This construction affords mainly a better insulation of the motor against excess voltage and a uniform excitation through the spark gap 7.

In Figure 5 a diagram is illustrated for transforming large current strengths which may be employed direct without motors, for example, for lighting or heating purposes. The main difference is that here the spark gap consists of a star shaped disc 7 which can rotate on its own axis and is rotated by a motor opposite similarly fitted electrodes 7<sup>a</sup>. When separate points of stars face one another, discharges take place, thus forming an oscillation circuit over condensers 5 and 6 and inductance 9 for oscillatory discharges. It is evident that a motor may also be directly connected to the ends of the spiral 9.

The construction of the diagram shown in Figure 6 permits of the oscillation circuit of the motor being connected with an induction coil. Here a regulating inductive resistance is introduced for counter-acting excess voltages in the motor. By cutting the separate coils 9 (coupled inductively to the aerial) in or out the inductive action on the motor may be more or less increased or variable aerial action may be exerted on the oscillation circuit.

In Figure 7 the oscillation circuit is closed through the earth (E and E<sub>1</sub>). The spark gap 7 may be prolonged or shortened by more or fewer spark gaps being successively connected by means of a contact arm 7<sup>b</sup>.

Diagram 8 shows a unipolar connection of the motor with the aerial network. Here two oscillation circuits are closed through the same motor. The first oscillation circuit passes from aerial A through electromagnet S, point  $x$ , inductance 9<sup>a</sup> to the earth condenser 6 and further, over spark gap 7 to the aerial condenser 5 and back to  $x$ . The second oscillation circuit starts from the aerial condenser 5 at the point  $x^1$  over the inductance 9 to the earth condenser 6 at the point  $x^2$  and through the condenser 6 over

the spark gap 7 back to  $x^1$ . The motor itself is inserted between the two points of the spark gap 7. From this arrangement slightly damped oscillation wave currents are produced.

In the diagram illustrated in Figure 9 a loosely coupled system of connections is illustrated which is assumed to be for small motors for measuring purposes. A indicates the aerial conductor, S the electromagnet in the aerial conductor, 9 the inductance, 7 the spark gap, 5 and 6 condensers, E the earth, M the motor, and 1 and 2 stator connections of the motor. The motor is directly metallicly connected with the oscillation circuit.

In Figure 10 a purely inductive coupling is employed for the motor circuit. The motor is connected with the secondary wire 10 as may be seen in Figure 11 in a somewhat modified diagram connection. The same applies to the diagram of Figure 12.

The diagrams hitherto described preferably allow of motors of small and medium strength to be operated. For large aggregates, however, they are too inconvenient as the construction of two or more oscillation circuits for large amounts of energy is difficult; the governing is still more difficult and the danger in switching on or off is greater.

A means of overcoming such difficulties is shown in Figure 13. The oscillation circuit here runs starting from the point  $x$  over condenser 5, variable inductance 9, spark gap 7 and the two segments (3<sup>a</sup> and 4<sup>a</sup>) forming arms of a Wheatstone bridge, back to  $x$ . If the motor is connected by brushes 3 and 4 transversely to the two arms of the bridge as shown in the drawings, electromagnetic oscillations of equal sign are induced in the stator surfaces 1 and 2 and the motor does not revolve. If however, the brushes 3 and 4 are moved in common with the conducting wires 1 and 2 which connect the brushes with the stator poles a certain alteration or displacement of the polarity is obtained and the motor commences to revolve.

The maximum action will result if one brush 3 comes on the central sparking contact 7 and the other brush 4 on the part  $x$ . They are however, usually in practice not brought on to the central contact 7 but only held in the path of the bridge segments 4<sup>a</sup> and 3<sup>a</sup> in order not to connect the spark gaps with the motor oscillation circuit.

As however, the entire oscillation energy can thereby not act on the motor it is better to carry out the same system according to the diagram 14. The diagram 14 differs from the foregoing only by the motor not being directly metallicly connected with the segments of the commutator, but only a primary coil 9 which induces in a secondary coil 10, current which feeds the motor M and takes the place of the rotor. By this



series, and consequently a three times greater air resistance is offered by the latter.

So long therefore, as the resistance of the spark gap 7 is not overloaded, so that the other spark gaps have an equal resistance with it the discharges take place only over spark gap 7. Should however the voltage be increased by any influences so that it might be dangerous for charging the condensers 5 and 6 or for the coil insulation 9 and 10 in consequence of breakdown, by a correct regulation of this spark gap the second spark gap can discharge free from inductive effects direct to earth without endangering the machine.

Without this second spark gap, arranged in parallel having a higher resistance than the working spark gap it is impossible to collect and render available large quantities of electrical energy.

The action of this closed oscillation circuit consisting of spark gap 7, two condensers 5 and 6, primary coil 9, and also secondary coil 10 is exactly the same as the one described in Figure 1 with the arrangement of the static induction machine with the only difference that here the second spark gap is provided. The electromagnetic high frequency alternating current obtained can be tapped off from the conductors 11 and 12 for lighting and heating purposes. Special kinds of motors adapted for working with these peculiar electrical charges may be connected at 14 and 15 which can work with static electricity charges or with high frequency oscillations.

In addition to the use of spark gaps in parallel a second measure of security is also necessary for taking off the current. This precaution consists according to this invention, in the introduction of and method of connecting certain protective electromagnets or choking coils in the aerial circuit as shown by S in Figure 3.

A single electromagnet only having a core of the thinnest possible separate laminations is connected with the aerial.

In the case of high voltages in the aerial network or at places where there are frequent thunder storms, several such magnets may however be connected in series.

In the case of large units or plants several electromagnets can be employed in parallel or in series parallel.

The windings of these electromagnets may be simply connected in series with the aeriels. In this case the winding preferably consists of several thin parallel wires, which make up together, the necessary section.

The winding may be made of primary and secondary windings in the form of a transformer. The primary winding will be then connected in series with the aerial network, and the secondary winding more or less short-circuited over a regulating resist-

ance or an induction coil. In the latter case it is possible to regulate to a certain extent the effect of the choking coils. In the further description of the connecting and constructional diagrams the aerial electromagnet choke coil is indicated by a simple ring S.

Figure 3 shows the simplest way of converting atmospheric electricity into electromagnetic wave energy by the use of special motors adapted for high oscillatory currents or static charges of electrical energy. Recent improvements in motors for working with static charges and motors working by resonance, that is to say, having groups of tuned electromagnetic cooperating circuits render this possible but such do not form part of the present invention.

A motor adapted to operate with static charges will for the sake of simplicity be diagrammatically indicated by two semi-circles 1 and 2 and the rotor of the motor by a ring M. (Figure 3.) A is a vertical aerial or aerial network. S the safety choke or electromagnet with coil O as may be seen is connected with the aerial A. Adjacent the electromagnet S the aerial conductor is divided into three circuits, the circuit 8 giving the safety spark gap, the circuit 7 with the working spark gap, and then a circuit including the stator terminal 1, the rotor and stator terminal 2 at which a connection is made to the earth wire. The two spark gaps are also connected metallically with the earth wire. The method of working these diagrams is as follows:

The positive atmospheric electric charge collected tends to combine with the negative electricity (or earth electricity) connected with the earth wire. It travels along the aerial A through the electromagnet S without being checked as it flows in the same direction as the direct current. Further, its progress is arrested by two sparks gaps placed in the way and the stator condenser surfaces. The stator condenser surfaces are charged until the charge is greater than the resistance of the spark gap 7, whereupon a spark springs over the spark gap 7 and an oscillatory charge is obtained as by means of the motor M, stator surfaces 1 and 2, and spark gap 7, a closed oscillation circuit is obtained for producing the electromagnetic oscillations. The motor here forms the capacity and the necessary inductance and resistance, which, as is well known, are necessary for converting static electricity into electromagnetic wave energy.

The discharges formed are converted into mechanical energy in special motors and can not reach the aerial network by reason of the electromagnet or choke. If, however, when a spark springs over the spark gap 7 a greater quantity of atmospheric electricity tends to flow to earth, a counter voltage is



arrangement a good transforming action is obtained, a loose coupling and also an oscillation circuit without a spark gap.

In Figure 15 the motor is not purely inductively as in 14, but directly metallicly branched off from the primary coil (at  $x$  and  $x'$ ) after the principle of the auto-transformer.

In Figure 16 instead of an inductance a condenser 6 is in similar manner, and for the same object inserted between the segments 3<sup>a</sup> and 4<sup>a</sup>. This has the advantage that the segments 3<sup>a</sup> and 4<sup>a</sup> need not be made of solid metal but may consist of spiral coils whereby a more exact regulation is possible and further motors of high inductance may be employed.

The arrangements of Figures 17, 18 and 19 may be employed for use with resonance and particularly with induction condenser motors; between the large stator induction condenser surfaces, small reversing pole condensers are connected, which, as may be seen from Figures 17, 18 and 19 are led together to earth. Such reversing poles have the advantage that with large quantities of electrical energy the spark formation between the separate oscillation circuits ceases.

Figure 19 shows a further method which prevents electromagnetic oscillations of high number of alternations formed in the oscillation circuit striking back to the aerial conductor. It is based on the well known principle that a mercury lamp, one electrode of which is formed of mercury, the other of solid metal such as steel allows an electric charge to pass in only one direction from the mercury to the steel and not vice versa. The mercury electrode of the vacuum tube N is therefore connected with the aerial conductor and the steel electrode with the oscillation circuit. From this it results that charges can pass only from the aerial through the vacuum tube to the oscillation circuit, but not vice versa. Oscillations which are formed on being transformed in the oscillation circuit cannot pass to the aerial conductor.

In practice these vacuum tubes must be connected behind an electromagnet as the latter alone affords no protection against the danger of lightning.

As regards the use of spark gaps, all arrangements as used for wireless telegraphy may be used. Of course the spark gaps in large machines must have a sufficiently large surface. In very large stations they are cooled in liquid carbonic acid or better still in liquid nitrogen or hydrogen; in most cases the cooling may also take place by means of liquefied low homologues of the metal series or by means of hydrocarbons the freezing point of which lies at between  $-90^{\circ}$  C. and  $-40^{\circ}$  C. The spark gap casing must also be insulated and be of

sufficient strength to be able to resist any pressure which may arise. Any undesirable excess super-pressure which may be formed must be automatically let off. I have employed with very good results mercury electrodes which were frozen in liquid carbonic acid, the cooling being maintained during the operation from the outside through the walls.

Figure 20 is one of the simplest forms of construction of an aerial network in combination with collectors, transformers and the like illustrated diagrammatically. E is here the earth wire, 8 the safety spark gap, 7 the working spark gap, 1 and 2 the stator surfaces of the motor, 5 a condenser battery, S the protective magnet which is connected with the coil in the aerial conductor, A<sup>1</sup> to A<sup>10</sup> aerial antennae with collecting balloons, N horizontal collecting or connecting wires from which, to the centre a number of connections run.

The actual collectors consist of metal sheaths preferably made of an aluminium magnesium alloy, and are filled with hydrogen or helium and are attached to copper plated steel wires. The size of the balloon is selected so that the actual weight of the balloon and the weight of the conducting wire is supported thereby. On the top of the balloon aluminium spikes, made and gilded in a special manner hereinafter described, are arranged in order to produce a conductor action. Small quantities of radium preparations, more particularly polonium-ironium or mesothorium preparations considerably increase the ionization, and therewith the action of these collectors.

In addition to metal balloons, fabric balloons which are superficially metal coated according to Schoop's metal spraying process, may however also be employed. A metallic surface may also be produced by lacquering with metallic bronzes, preferably according to Schoop's spraying process or lacquering with metallic bronze powders in two electrical series of widely different metals, because thereby the collecting effect is considerably increased.

Instead of the ordinary round balloons, elongated cigar shaped ones may be employed. In order also to utilize the frictional energy of the wind, patches or strips of non-conducting substances which produce electricity by friction, may be attached to the metallized balloon surfaces. The wind will impart a portion of its energy in the form of frictional electricity, to the balloon casing, and thereby the collecting effect is substantially increased.

In practice however, very high towers (up to 300 metres is fully admissible) may be employed as antennae. In these towers copper tubes rise freely further above the top of the tower. A gas lamp secured



against the wind is then lit at the point of the copper tube and a netting is secured to the copper tube over the flame of this lamp to form a collector. The gas is conveyed through the interior of the tube up to the summit. The copper tube must be absolutely protected from moisture at the place at which it enters the tower and also rain must be prevented running down the walls of the tower which might lead to a bad catastrophe. This is done by bell shaped enlargements which expand downwards, being arranged in the tower in the form of high voltage insulators of Siamese pagodas.

Special attention must be devoted to the foundations of such towers. They must be well insulated from the ground, which may be obtained by first embedding a layer of concrete in a box form to a sufficient depth in the ground and inserting in this an asphalt lining and then glass bricks cast about 1 or 2 metres in thickness. Over this in turn there is a ferro-concrete layer in which alone the metal foot of the tube is secured. This concrete block must be at least 2 metres from the ground and be fully protected at the sides by a wooden covering, from moisture. In the lower part of the tower a wood or glass house for the large condenser batteries or for the motors may be constructed. In order to lead the earth connection to the ground water, a well insulated pit constructed of vitreous bricks, must be provided. Several such towers are erected at equal distances apart and connected with a horizontal conductor. The horizontal connecting wires may either run directly from tower to tower or be carried on bell shaped insulators similar to those in use for high voltage conductors. The width of the network may be of any suitable size and the connection of the motors can take place at any suitable places.

In order to collect large quantities of electricity with few aeriels it is well to provide the aerial conductor with batteries of condensers as shown in two methods of construction in Figures 21 and 22. In Figure 21 the batteries of condensers 5 are connected on the one hand with the aerial electricity collectors Z by the aerial conductor A, and on the other hand interconnected in series with an annular conductor from which horizontal conductors run to the connecting points C to which the earth wire is connected.

Figure 22 shows a similar arrangement. Should two such series of antennæ rings be shown by a voltmeter to have a large difference of potential (for example, one in the mountains and one in the plain) or even of different polarity these differences may be compensated for by connecting sufficiently large condenser batteries (5, 5<sup>a</sup>, 5<sup>b</sup>) by means of Maji star conductors D and D'. In Fig-

ure 23 a connection of three such rings of collectors to form a triangle with a central condenser battery is illustrated.

The condenser batteries of such large installations must be embedded in liquefied gases or in liquids freezing at very low temperatures. In such cases a portion of the atmospheric energy must be employed for liquefying these gases. It is also preferable to employ pressure. By this means the condenser surfaces may be diminished, and still allow for large quantities of energy to be stored, secure against breakdown. For smaller installations the immersing of the condensers in well insulated oil or the like, suffices. Solid substances on the other hand cannot be employed as insulators.

The arrangement in the diagrams hitherto described was always such that the condenser batteries were connected with both poles directly to the aerial conductors. An improved diagram of the connections for obtaining atmospheric electricity for the condenser batteries has however, been found to be very advantageous, this arrangement consists in that they are connected by only one pole (unipolar) to the collecting network. Such a method of arrangement is very important, as by means of it a constant current and an increase of the normal working pressure or voltage is obtained. If for example a collecting balloon aerial which is allowed to rise to a height of 300 metres, shows 40,000 volts above earth voltage, in practice it has been found that the working voltage (with a withdrawal of the power according to the method hereinbefore described by means of oscillating spark gaps and the like) is only about 400 volts. If however, the capacity of the condenser surfaces be increased, which capacity in the above mentioned case was equal to that of the collecting surface of the balloon aeriels, to double the amount, by connecting the condenser batteries with only one pole, the voltage rises under an equal withdrawal of current up to and beyond 500 volts. This can only be ascribed to the favourable action of the connecting method.

In addition to this substantial improvement it has also been found preferable to insert double inductances with electromagnets and to place the capacities preferably between two such electromagnets. It has also been found that the useful action of such condensers can be further increased if an induction coil be connected as inductive resistance to the unconnected pole of the condenser, or still better if the condenser itself be made as an induction condenser. Such a condenser may be compared with a spring which when compressed carries in itself accumulated force, which it again gives off when released. In charging, a charge with reversed sign is formed at the



other free condenser pole, and if through the spark gap a short circuit results, the accumulated energy is again given back since now new quantities of energy are induced at the condenser pole connected with the conductor network, which in fact charges with opposite signs to that at the free condenser pole. The new induced charges have of course the same sign as the collector network. The whole voltage energy in the aerial is thereby however increased. In the same space of time larger quantities of energy are accumulated than is the case without such inserted condenser batteries.

In Figures 24 and 25 two different diagrams of connections are more exactly illustrated, Figure 24 shows a collecting balloon and the diagram of the connections to earth. Figure 25 four collecting balloons and the parallel connection of the condenser batteries belonging thereto.

A is the collecting balloon made of an aluminium magnesium alloy (electron metal, magnalium) of a specific gravity of 1.8 and a thickness of plate 0.1 to 0.2 mm. Inside there are eight strong vertical ribs of T shaped section about 10 to 20 mm. in height and about 3 mm. in thickness with the projecting part directed inwards (indicated by *a, b, c, d* and so forth); they are riveted together to form a firm skeleton and are stiffened in a horizontal direction by two cross ribs. The ribs are further connected with one another internally and transversely by means of thin steel wires, whereby the balloon obtains great power of resistance and elasticity. Rolled plates of 0.1 to 0.2 mm. in thickness made of magnalium alloy are then either soldered or riveted on this skeleton so that a fully metallic casing with smooth external surface is obtained. Well silvered or coppered aluminium plated steel wires run from each rib to the fastening ring 2. Further, the coppered steel hawser L preferably twisted out of separate thin wires (shown in dotted lines in Figure 24) and which must be long enough to allow the balloon to rise in the desired height, leads to a metal roller or pulley 3 and from thence to a winch W, well insulated from the earth. By means of this winch, the balloon, which is filled with hydrogen, or helium, can be allowed to rise to a suitable height (300 to 5,000 metres) and brought to the ground for recharging or repairs.

The actual current is taken directly through a friction contact from the metal roller 3 or from the wire, or even from the winch or simultaneously from all three by means of brushes (3, 3<sup>a</sup> and 3<sup>b</sup>). Beyond the brushes the conductor is divided, the paths being:—firstly over 12 to the safety spark gap 8, from thence to the earth conductor E<sup>2</sup>, and secondly over electromagnet S<sup>1</sup>, point 13, to a second loose electromagnet

having an adjustable coil S<sup>2</sup>, then to the spark gap 7 and to the second earth conductor E<sup>2</sup>. The actual working circuit is formed through the spark gap 7, condensers 5 and 6, and through the primary coil 9; here the static electricity formed by oscillatory discharges is accumulated and converted into high frequency electromagnetic oscillations. Between the electromagnets S<sup>1</sup> and S<sup>2</sup> at the crossing point 13, four condenser batteries are introduced which are only indicated diagrammatically in the drawings each by one condenser. Two of these batteries (16 and 18) are made as plate condensers and prolonged by regulating induction coils or spirals 17 and 19 while the two others (21 and 23) are induction condensers. As may be seen from the drawings each of the four condenser batteries 16, 18, 21, 23 is connected only by one pole to the aerial or to the collector conductor. The second poles 17, 19, 22, 24 are open. In the case of plate condensers having no inductive resistance an induction coil is inserted. The object of such a spiral or coil is the displacement of phase of the induction current by  $\frac{1}{4}$  periods, whilst the charging current of the condenser poles which lie free in the air, works back to the collector aerial. The consequence of this is that in discharges in the collector aerial the back inductive action of the free poles allows a higher voltage to be maintained in the aerial collecting conductor than would otherwise be the case. It has also been found that such a back action has an extremely favourable effect on the wear of the contacts. Of course the inductive effect may be regulated at will within the limits of the size of the induction coil, the length of the coil in action being adjustable by means of wire connection without induction (see Fig. 24, No. 20).

S<sup>1</sup> and S<sup>2</sup> may also be provided with such regulating devices in the case of S<sup>2</sup> (illustrated by 11). If excess voltage be formed it is conducted to earth through the wire 12 and spark gap 8 or through any other suitable apparatus, since this formation would be dangerous for the other apparatus.

The action of these condenser batteries has already been hereinbefore described.

The small circles on the collector balloon indicate places at which zinc amalgam or gold amalgam or other photoelectric acting metals in the form of small patches in extremely thin layers (.01 to .05 mm. in thickness) are applied to the balloon casing of light metal. Such metallic patches may also be applied to the entire balloon as well as in greater thickness to the conducting network. The capacity of the collector is thereby considerably strengthened at the surface. The greatest possible effect in collecting may be obtained by polonium amalgams and the like. On the surface of the



collector balloon metal points or spikes are also fixed along the ribs, which spikes serve particularly for collecting the collector charge. Since it is well known that the resistance of the spikes is less the sharper the spike is, for this purpose it is therefore extremely important to employ as sharp spikes as possible. Experiments made as regards these have shown that the formation of the body of the spike or point also plays a large part. For example, spikes made of bars or rollers with smooth surfaces, have a many times greater point resistance as collector accumulator spikes than those with rough surfaces. Various kinds of spike bodies have been experimented with for the collector balloons hereinbefore mentioned. The best results were given by spikes which were made in the following way. Fine points made of steel, copper, nickel, or copper and nickel alloys, were fastened together in bundles and then placed as anode with the points in a suitable electrolyte (preferably in hydrochloric acid or muriate of iron solutions) and so treated with weak current at 2 to 3 volts pressure. After 2 to 3 hours according to the thickness of the spikes or pins the points become extremely sharp and the bodies of the spikes have a rough surface. The bundle can then be removed and the acid washed off with water. The spikes are then placed as cathode in a bath consisting of solution of gold, platinum, iridium, palladium or wolfram salts or their compounds and coated at the cathode galvanically with a thin layer of precious metal, which must however be sufficiently firm to protect them from atmospheric oxidation.

Such spikes act at a 20 fold lower voltage almost as well as the best and finest points made by mechanical means. Still better results are obtained if polonium or radium salts are added to the galvanic bath when forming the protective layer or coating. Such pins have a low resistance at their points and even at one volt and still lower pressures have an excellent collector action.

In Figure 24 the three unconnected poles are not connected with one another in parallel. That is quite possible in practice without altering the principle of the free pole. It is also preferable to interconnect in parallel to a common collector network, a series of collecting aeri-als.

Figure 25 shows a diagram for such an installation.  $A^1, A^2, A^3, A^4$  are four metal collector balloons with gold or platinum coated spikes which are electrolytically made in the presence of polonium emanations or radium salts, which spikes or needles are connected over four electro-magnets  $S^1, S^2, S^3, S^4$ , through an annular conductor R. From this annular conductor four wires run over four further electromagnets  $S^5,$

$S^6, S^7, S^8$ , to the connecting point 13. There the conductor is divided, one branch passing over 12 and the safety spark gap S to the earth at  $E^1$ , the other over inductive resistance J and working spark gap 7 to the earth at  $E^2$ . The working circuit, consisting of the condenser 5 and 6 and a resonance motor or a condenser motor M, such as hereinbefore described, is connected in proximity round the sparking gap section 7.

Instead of directly connecting the condenser motor of course the primary circuit for high frequency oscillatory current may also be inserted.

The condenser batteries are connected by one pole to the annular conductor R and can be either inductionless (16 and 18) or made as induction condensers as shown by 21 and 23. The free poles of the inductionless condensers are indicated by 17 and 19, those of the induction condensers by 22 and 24. As may be seen from the drawings all these poles 17, 22, 19, 24 may be interconnected in parallel through a second annular conductor without any fear that thereby the principle of the free pole connection will be injured. In addition to the advantages already set forth the parallel connection also allows of an equalization of the working pressure in the entire collector network. Suitably constructed and calculated induction coils 25 and 26 may also be inserted in the annular conductor of the free poles, by means of which a circuit may be formed in the secondary coils 27 and 28 which allows current produced in this annular conductor by fluctuations of the charges or the like appearances to be measured or otherwise utilized.

According to what has been hereinbefore stated separate collector balloons may be connected at equidistant stations distributed over the entire country, either connected directly with one another metallically or by means of intermediate suitably connected condenser batteries through high voltage conductors insulated from earth. The static electricity is converted through a spark gap into dynamic energy of a high number of oscillations and may in such form be coupled as a source of energy by means of a suitable method of connecting, various precautions being observed, and with special regulations. The wires leading from the collector balloons have hitherto been connected through an annular conductor without this endless connection, which can be regarded as an endless induction coil, being able to exert any action on the whole conductor system.

It has now been found that if the network conductor connecting the aerial collector balloons with one another is not made as a simple annular conductor, but preferably short circuited in the form of coils over a



condenser battery or spark gap or through thermionic tubes or valves or audions, then the total collecting network exhibits quite new properties. The collection of atmospheric electricity is thereby not only increased but an alternating field may be easily produced in the collector network. Further, the atmospheric electrical forces showing themselves in the higher regions may also be directly obtained by induction. In Figures 26 and 28 a form of construction is shown on the basis of which the further foundations of the method will be more particularly explained.

In Figure 26 1, 2, 3, 4 are metal collector balloons, 5, 6, 7, 8 their metallic aerial conductors and I the actual collector network. This consists of five coils and is mounted on high voltage insulators in the air, on high voltage masts (or with a suitable construction of cable embedded in the earth). One coil has a diameter of 1 to 100 km. or more. S and S' are two protective electromagnets, F the second safety section against excess voltage, E its earth conductor and E' the earth conductor of the working section. When an absorption of static atmospheric electricity is effected through the four balloon collectors, the current in order to reach the earth connection E' must flow spirally through the collector network over the electromagnet S, primary induction coil 9, conductor 14, anode A of the audion tube, incandescent cathode K, as the way over the electromagnet and safety spark gap F offers considerably greater resistance. Owing to the fact that the accumulated current flows in one direction, an electromagnetic alternating field is produced in the interior of the collector network coil, whereby the whole free electrons are directed more or less into the interior of the coil. An increased ionization of the atmosphere is therefore produced. In consequence of this the points mounted on the collector balloon show a considerably reduced resistance and therefore increased static charges between the points on the balloon and the surrounding atmosphere are produced. The result of this is a considerably increased collector effect.

A second effect which could not be obtained otherwise is obtained by the electromagnetic alternating field which running parallel to the earth surface, acts more or less with a diminishing or increasing effect on the earth magnetic field, whereby in the case of fluctuations in the current a return induction current of reversed sign is always produced in the collector coil by earth magnetism. Now if, however, a constantly pulsating continuous alternating field is produced as stated in the above collector network I, an alternating current of the same periodicity is produced also in the collecting

network coil. As the same alternating field is further transmitted to the aerial balloon, the resistance of its points is thereby considerably reduced, whilst the collector action is considerably increased. A further advantage is that positive electrons which collect on the metal surfaces during the conversion into dynamic current produce a so-called drop of potential of the collector area. As an alternating field is present, the negative ions surrounding the collector surfaces, when discharge of the collector surfaces takes place produce by the law of induction, an induction of reversed sign on the collector surface and so forth (that is to say again a positive charge). In addition to the advantages hereinbefore set forth, the construction of connecting conductors in coil form when of sufficiently large diameter, allows of a utilization of energy arising in higher regions also in the simplest way. As is well known electric discharges frequently take place at very great elevations which may be observed, such as St. Elmo's fires or northern lights. These energy quantities have not been able to be utilized up to now. By this invention all kinds of energy, as they are of an electromagnetic nature and the direction of the axis of the collector coils stands at right angles to the earth's surface, can be more or less absorbed in the same way as a receiver in wireless telegraphy absorbs waves coming from a far distance. With a large diameter of the spiral it is possible to connect large surfaces and thereby to take up also large quantities of energy.

It is well known that large wireless stations in the summer months, and also in the tropics are very frequently unable to receive the signals in consequence of interruptions which are caused by atmospheric electricity, and this takes place with vertical coils of only 40 to 100 m. diameter. If on the contrary horizontal coils of 1 to 100 km. diameter be employed very strong currents may be obtained through discharges which are constantly taking place in the atmosphere. Particularly in the tropics or still better in the polar regions where the northern lights are constantly present, large quantities of energy may probably be obtained in this way. A coil with several windings should act the best. In similar manner any alteration of the earth magnetism should act inductively on such a coil.

It is not at all unlikely that earthquakes and spots on the sun will also produce an induction in such collector coils of sufficient size. In similar manner this collector conductor will react on earth currents more particularly when they are near the surface of the earth or even embedded in the earth. By combining the previous kind of current collectors so far as they are adapted for



the improved system with the improved possibilities of obtaining current the quantities of free natural energy which are to be obtained in the form of electricity are considerably increased.

In order to produce in the improved collector coil uniform current oscillations of an undamped nature so-called audion high vacuum or thermionic tubes of suitable connection are employed instead of the previously known spark gaps (Fig. 26, Nos. 9-18). The main aerial current flows through electromagnet S (which in the case of a high number of alternations is not connected here but in the earth conductor  $E^1$ ) and may be conveyed over the primary coils in the induction winding through wire 14 to the anode A of the high vacuum grid tube. Parallel with the induction resistance 9 a regulating capacity of suitable size, such as condenser 11 is inserted. In the lower part of the vacuum grid tube is arranged the incandescent filament or the cathode K which is fed through a battery B. From the battery B two branches run, one to the earth conductor  $E^1$  and the other through battery  $B^1$  and secondary coil 10 to the grid anode  $g$  in the vacuum tube. By the method of connections shown in dotted lines, a desired voltage at the grid electrode  $g$  may also be produced through the wire 17 which is branched off from the main current conductor through switches 16 and some small condensers (*a, b, c, d*) connected in series, and conductor 18, without the battery  $B^1$  being required.

The action of the entire system is somewhat as follows:—

On the connecting conductor of the aerial collector network being short circuited to earth, the condenser pole 11 is charged and slightly damped oscillations are formed in the short circuited existing oscillation circuit formed of the condenser 11 and self inductance 9. In consequence of the coupling through coil 10, fluctuations of voltage take place in the grid circuit 15 with the same frequency, which, fluctuations in turn influence the strength of the electrode current passing through the high vacuum amplifying tube and thus produce current fluctuations of the same frequency in the anode circuit. A permanent supply of energy to the oscillation circuits 9 and 10 consequently takes place, until a condition of balance is set up, in which the consumed oscillation energy is equal to that absorbed. Thereby constant undamped oscillations are now produced in the oscillation circuits 9-11.

For regular working of such oscillation producers high vacuum strengthening tubes are necessary and it is also necessary that the grid and anode voltages shall have a phase difference of  $180^\circ$  so that if the grid is negatively charged, then the anode is

positively charged and vice versa. This necessary difference of phase may be obtained by most varied connections, for example, by placing the oscillation circuit in the grid circuit or by separating the oscillation circuit and inductive coupling from the anodes and the grid circuit and so forth.

A second important factor in this way of converting static atmospheric electricity into undamped oscillations is that care must be taken that the grid and anode voltages have a certain relation to one another; the latter may be obtained by altering the coupling and a suitable selection of the self induction in the grid circuit, or as shown by dotted lines 18, 17, 16 by means of a larger or smaller number of condensers of suitable size connected in series; in this case the battery  $B^1$  may be omitted. With a suitable selection of the grid potential a glow discharge takes place between the grid  $g$  and the anode A, and accordingly at the grid there is a cathode drop and a dark space is formed. The size of this cathode drop is influenced by the ions which are emitted in the lower space in consequence of shock ionization of the incandescent cathodes K and pass through the grid in the upper space. On the other hand the number of the ions passing through the grid is dependent on the voltage between the grid and the cathode. Thus if the grid voltage undergoes periodic fluctuations (as in the present case) the amount of the cathode drop at the grid fluctuates and consequently the internal resistance of the tube correspondingly fluctuates, so that when a back coupling of the feed circuit with the grid circuit takes place, the necessary means are afforded for producing undamped oscillations and of taking current, according to requirements from the collecting conductor.

The frequency of the undamped oscillations produced is with a suitably loose coupling equal to the self frequency of the oscillation circuits 9 and 10. By a suitable selection of the self induction of the coil 9 and capacity 11 it is possible to extend from frequencies which produce electromagnetic oscillations of only a few metres wave length down to the lowest practical alternating current frequency. For large installations a suitable number of frequency producing tubes in the form of the well known high vacuum transmission tubes of .5 to 2 kw. in size may be connected in parallel so that in this respect no difficulty exists.

The use of such tubes for producing undamped oscillations, and also the construction and method of inserting such transmission tubes in an accumulator or dynamo circuit is known and also that such oscillation producing tubes only work well at voltages of 1,000 up to 4,000 volts, so that on the contrary their use at lower voltages is



considerably more difficult. By the use of high voltage static electricity this method of producing undamped oscillations as compared with that through spark gaps must be regarded as an ideal solution particularly for small installations of outputs of from 1 to 100 kw.

By the application of safety spark gaps, with interpolation of electro-magnets, not only is short circuiting avoided but also the taking up of current is regulated. Oscillation producers inserted in the above way form a constantly acting electromagnetic alternating field in the collector coil, whereby as already stated, a considerable accumulating effect takes place. The withdrawal wire or working wire is connected at 12 and 13, but current may be taken by means of a secondary coil which is firmly or movably mounted in any suitable way inside the large collector coil, i. e. in its electromagnetic alternating field, so long as the direction of its axis runs parallel with that of the main current collecting coil.

In producing undamped oscillations of a high frequency (50,000 per second and more) in the oscillation circuits 9 and 11, electromagnets S and S<sup>1</sup> must be inserted if the high frequency oscillations are not to penetrate the collector coil, between the oscillation producers and the collector coil. In all other cases they are connected shortly before the earthing (as in Figs. 27 and 28).

In Figure 27 a second method of construction of the connecting conductor of the balloon aeri-als is illustrated in the form of a coil. The main difference consists in that in addition to the connecting conductor I another annular conductor II is inserted parallel to the former on the high voltage masts in the air (or embedded as a cable in the earth) but both in the form of a coil. The connecting wire of the balloon aeri-als is indicated as a primary conductor and also as a current producing network; the other is the consumption network and is not in unipolar connection with the current producing network.

In Figure 27 the current producing network I is shown with three balloon collectors 1, 2, 3 and aerial conductors 4, 5, 6; it is short circuited through condenser 19 and inductance 9. The oscillation forming circuit consists in this diagram of spark gap f, inductance 10, and condenser 11; the earth wire E, is connected to earth over electromagnet S<sup>1</sup>. F is the safety spark gap which is also connected to earth through a second electromagnet S at E. On connecting up the condenser circuit 11 this is charged over the spark gap f whereby an oscillatory discharge is formed. This discharging current acts through inductance 10 on the inductively coupled secondary 9, whereby in the producing network a modi-

fication of the potential of the condenser 19 is produced. The consequence of this is that oscillations arise in the coil shaped producer network. These oscillations induce a current in the secondary circuit II, which has a smaller number of windings and a less resistance, the voltage of which, according to the proportion of the number of windings and of the ohmic resistance, is considerably lower whilst the current strength is greater.

In order to convert the current thus obtained into current of an undamped character, and to tune its wave lengths, a sufficiently large regulatable capacity 20 is inserted between the ends 12 and 13 of the secondary conductor II. Here also current may be taken without an earth conductor, but it is advisable to insert a safety spark gap E<sup>1</sup> and to connect this with the earth over an electromagnet S<sup>2</sup>.

The producer network may be connected with the working network II over an inductionless condenser 21 or over an induction condenser 22, 23. In this case the secondary conductor is unipolarly connected with the energy conductor.

In Figure 28 the connecting conductor between the separate accumulator balloons is carried out according to the autotransformer principle. The collecting coil connects four aerial balloons 1, 2, 3, 4, the windings of which are not made side by side but one above the other. In Figure 28 the collector coil I is shown with a thin line, the metallicly connected prolongation coils II with a thick line. Between the ends I<sup>1</sup> and II<sup>1</sup> of the energy network I a regulating capacity 19 is inserted. The wire I<sup>1</sup> is connected with the output wire and with the spark gap F.

As transformer of the atmospheric electricity an arrangement is employed which consists in using rotary pairs of condensers in which the one stator surface B is connected with the main current, whilst the other A is connected with the earth pole. Between these pairs of short circuited condensers are caused to rotate from which the converted current can be taken by means of two collector rings and brushes, in the form of an alternating current, the frequency of which is dependent on the number of balloons and the revolutions of the rotor. As the alternating current formed in the rotor can act, in this improved method of connection described in this invention, through coils 10 on the inductance 9, an increase or diminution of the feed current in I can be obtained according to the direction of the current by back induction. Current oscillations of uniform rhythm thereby result in the coil shaped windings of the producer network.

As the ends of this conductor are short cir-



cuted through the regulatable condenser 19 these rhythms produce short circuited undamped oscillations in the energy conductor, the periodicity and wave lengths of which oscillations can be adjusted according to desire by altering the capacity 19 to a given wave length and therewith also to a given frequency. These currents may also be employed in this form directly as working current through the conductors II<sup>1</sup> and III. By inserting the condenser 20 a connection between these conductors may also be made, whereby harmonic oscillations of desired wave length are formed. By this means quite new effects as regards current distribution are obtained. The withdrawal of current can even take place without direct wire connection if, at a suitable point in the interior of the producing network (quite immaterially whether this has a diameter of 1 or 100 km.) a coil tuned to these wave lengths and of the desired capacity is firmly or movably mounted in the aerial conductor in such a way that its axial direction is in parallel with that of the collector coil. In this case a current is induced in the producing network, the size of which is dependent on the total capacity and resistance and also on the periodicity employed. A possibility is thereby afforded in future, of taking energy from the producer network by wireless means. As thereby in addition to atmospheric electricity also magnetic earth currents and the energy from the higher atmosphere (at least partially) may be simultaneously obtained, this last system for collecting the atmospheric energy is of particular importance for the future.

Of course everywhere instead of spark gaps suitable grid vacuum tubes may be employed as producers for undamped oscillations. The separate coils of the producer network with large diameters may be connected with one another through separate conductors all in parallel or all in series or in groups in series. By regulating the number of oscillations and also the extent of the voltage more or less large collector coils of this kind may be employed. The coils may also be divided spirally over the entire section. The coils may be carried out in annular form or also in triangular, quadrangular, hexagonal or octagonal form.

Of course wires may be carried from a suitable place to the centre or also laterally which serve the current waves as guides. This is necessary when the currents have to be conducted over mountains and valleys and so forth. In all these cases the current must be converted into a current of suitable periodicity.

As already hereinbefore mentioned separate collecting balloons may be directly metallicly interconnected at equidistant sta-

tions distributed over the entire country or may be connected by interpolation of suitable condenser batteries by means of high voltage conductors. The static electricity is converted through a spark gap into dynamic energy of a high number of oscillations, and could then in such form, with a suitable arrangement of the connections, observing various measures of precaution, be employed as source of energy after separate or special regulation.

According to this invention in order to increase the collecting effect of the balloon in the aerial collector conductor or in the earth wire, radiating collectors are employed. These consist either of incandescent metal or oxide electrodes in the form of vacuum grid tubes, or electric arcs (mercury and the like electrodes) Nernst lamps, or finally flames of various kinds may be simply connected with the respective conductor.

It is well known that energy can be drawn off from a cathode consisting of an incandescent body opposite an anode charged with positive electricity (vacuum grid tube). Hitherto however, a cathode was always first directly placed opposite an anode, and secondly the system always consisted of a closed circuit.

Now if we dispense with the ordinary ideas in forming light or flame arcs in which a cathode must always stand directly opposite an anode, and if we place an incandescent cathode opposite an anode charged to a high potential or another body freely floating in the air, or regard the incandescent cathode only as a source of unipolar discharge (which represent group and point discharges in electro-static machines similar to unipolar discharges), it may be ascertained that incandescent cathodes and less perfectly all incandescent radiators, flames and the like admit of relatively large current densities and allow large quantities of electric energy to radiate into the open space in the form of electron streams as transmitters.

The object of this invention is as described below, if such incandescent oxide electrodes or other incandescent radiators or flames are not freely suspended in space but connected metallicly with the earth so that they can be charged with negative terrestrial electricity, these radiators possess the property of absorbing the free positive electrical charges contained in the air space surrounding them (that is to say of collecting them and conducting them to earth). They can therefore, serve as collectors and have, in comparison to the action of the spikes, or points, a very large radius of action R; the effective capacity of these collector is much greater than the geometrical capacity ( $R_0$ ) calculated in an electro-static sense.

Now as our earth is surrounded as is well



known, with an electro-static field and the difference of potential

$$\frac{\delta V}{\delta h}$$

of the earth field according to the latest investigations, is in summer about 60 to 100 volts and in winter 300 to 500 volts per metre of difference in height ( $\delta h$ ), a simple calculation gives the result that when such a radiation collector or flame collector is arranged for example on the ground, and a second one is mounted vertically over it at a distance of 2,000 metres and both are connected by a conducting cable, there is a difference of potential in summer of about 2,000,000 volts and in winter even of 6,000,000 volts and more.

According to Stefan Boltzmann's law of radiation, the quantity of energy which an incandescent surface (temperature  $T$ ) of 1 sq. cm. radiates in a unit of time into the open air (temperature  $T_0$ ) is expressed by the following formula:

$$S = \sigma (T^4 - T_0^4) \text{ watt/sq. cm.}$$

and the universal radiation constant  $\sigma$  is according to the latest researches of Ferry (Annales de Chimie et de physique 17 page 267 (1909)) equal to  $6.30 \times 10^{-12}$  watt/sq. cm.

Now if an incandescent surface of 1 sq. cm. shows, as compared with the surrounding space a periodic fall of potential  $\delta V$  it radiates (independent of the current direction, that is to say of the sign) in accordance with the above formula, for example at a temperature of  $3725^\circ$  C. an energy of 1.6 kw. per sq. cm. per second. As for the radiation the same value can be calculated for the collection of energy, but reversed. Now as carbon electrodes at the temperature of the electric arc support on the current basis a current density up to from 60 to 65 amperes per sq. cm. no difficulties will result in this direction in employing radiating collectors as accumulators.

If the earth be regarded as a cosmically insulated condenser in the sense of geometrical electro-statics  $\alpha$  there results from the geometric (compare Ewald Rasch, "das elektrische Bogenlicht" (The electric arc light) page 169) capacity of the earth according to Chwolson:

For negative charging  $1.3 \times 10^6$  Coulomb  
 For negative potential  $V = 10 \times 10^8$  volts.  
 From this there results however,  $EJT \approx 24.7 \times 10^{24}$  watt/Sec. Now if it is desired to make a theoretic short circuit through an earthed flame collector this would represent an electric total work of about 79,500  $10^{10}$  kilowatt years. As the earth must be regarded as a rotating mechanism which is thermo-dynamically, electromagnetically, and also kinematically coupled with the sun and stars system by cosmic radiations and

gravitation a diminution of the electric energy of the earth field is not to be feared. The energies which the incandescent collectors would withdraw from the earth field can only cause by the withdrawal of motor work a lowering of the earth temperature (temperature  $T_E = 300$ ) and reduce this to that of the world space ( $T = 0$ ) by using the entire energy. This is however not the case as the earth does not represent a cosmically entirely insulated system. On the contrary there is conveyed to the same according to the recent value corrected by Ferry for the solar constants through the radiation from the sun an energy of  $18,500 \times 10^{10}$  kw. Accordingly any lowering of the earth temperature ( $T_E$ ) without a simultaneous lowering of the sun's temperature ( $T_S$ ) would contradict Stefan Boltzmann's law of radiation.

$$S = \sigma (T_S^4 - T_E^4).$$

From this it must be concluded that if the earth temperature ( $T_E$ ) sinks, the total radiation  $S$  absorbed by the earth increases, and further also that the secular speed of cooling of the earth is directly dependent on that of the sun and the other radiators cosmically coupled with the sun and is connected most closely with these.

The incandescent radiation collectors may, according to this invention, be employed for collecting atmospheric electricity if they (1) are charged with the negative earth electricity (that is to say when they are directly connected by means of a metallic conductor with the earth) and (2) if large capacities (metal surfaces) charged with electricity are mounted opposite them as positive poles in the air. This is regarded as the main feature of the present invention as without these inventive ideas it would not be possible to collect with an incandescent collector, sufficiently large quantities of the electrical charges contained in the atmosphere as technology requires; the radius of action of the flame collectors would also be too small, especially if it be considered that the very small surface density (energy density) ( $\delta$  about  $= 2 \times 7 \cdot 10^9$  St. E. per sq. cm.) does not allow of large quantities of charge being absorbed from the atmosphere.

$\alpha$ ) Calculated according to Poisson's calculation;

$\Delta V = -4\pi\delta$ ; as here the alteration of the potential or potential gradients only takes place in the direction of the normal, this calculation assumes the simple form

$$\delta = \frac{1}{4\pi} \times \frac{\delta^2 V}{\delta r^2}$$

It has indeed already been proposed to employ flame collectors for collecting atmospheric electricity and it is known that



candescent cathode and also the positive electrode may be enclosed in a vacuum chamber as may be seen in Fig. 32. A cable L is carried well insulated through the cover of a vessel and ends in a condenser disc 5. The cover is arched in order to keep off the rain. The vessel is entirely or partially made of magnetic metal and well insulated inside and outside. Opposite the disc 5 another disc 6 and on this again a metallic positive pole of the vacuum tube *g* with the incandescent cathode (oxide electrode) N is arranged. The negative electrode is on the one hand connected with the earth conductor E, and on the other hand with the inductive resistance 9 which is also connected with the cable L with the positive pole and wound round the vessel in coils. The action is exactly the same as that in Fig. 29 only instead of an open incandescent cathode one enclosed in vacuo is employed. As in such collectors only small bodies can be brought to incandescence in large installations a plurality of such vacuum tubes must be inserted in proximity to one another. According to the previous constructions Figs. 31 and 33 are quite self evident without further explanations.

Figs. 34-37 represent further diagrams of connections over radiating and flame collectors, and in fact, how they are to be arranged on the ground.

Fig. 34 shows an arc light collector with oxide electrodes for direct current and its connection; Fig. 35 a similar one for alternating current, Fig. 36 an incandescent collector with a Nernst lamp and Fig. 37 a similar one with a gas flame.

The positive pole 1 of the radiating collectors is always directly connected to the aerial collecting conductor A. In Fig. 34 this is further connected over the condenser battery 5 with a second positive electrode 3. The direct current dynamo *b* produces current which flows over between the electrodes 3 and 2 as an arc light. On the formation of an arc the negative incandescent electrode 2 absorbs electricity from the positive poles standing opposite it and highly charged with atmospheric electricity and conveys the same to the working circuit. The spark gap 7, inductive resistance 9 and induction coil 10 are like the ones previously described. The protective electromagnet S guards the installation against earth circuiting, the safety spark gap 8 from excess voltage or overcharging.

In Fig. 35 the connection is so far altered that the alternating current dynamo feeds the exciting coil 11 of the induction condenser. 12 is its negative and 13 its positive pole; if the coil 3 on the magnet core of the dynamo is correctly calculated and the periodicity of the alternating current is sufficiently high an arc light can be formed

between the two poles 1 and 2. As the cathode 2 is connected with the negatively charged earth, and therefore always acts as a negative pole, a form of rectification of the alternating current produced by the dynamo 3 is obtained, the second half of the period is always suppressed. The working circuit may be carried out in the same way as in Fig. 34; the working spark gap 7 may however be dispensed with, and instead thereof between the points *n* and *m* a condenser 5 and an induction resistance 9 may be inserted from which the current is taken inductively.

Fig. 36 represents a form of construction similar to Fig. 34 only that here instead of an arc lamp a Nernst incandescent body is employed. The Nernst lamp is fed through the battery 3. The working section is connected with the negative pole, the safety spark gap with the + poles. The working spark gap 7 may also be dispensed with and the current for it taken at 12 over the oscillation circuit 5, 11 (shown in dotted lines).

Flame collectors (Fig. 37) may also be employed according to this invention. The wire network 1 is connected with the aerial collector conductor A and the burner with the earth. At the upper end of the latter, long points are provided which project into the flame. The positive electrode is connected with the negative over a condenser 5 and the induction coil 9 with the earth.

The novelty in this invention is firstly, the use of incandescent cathodes opposite positive poles which are connected with large metallic capacities as automatic collecting surfaces, (2) the connection of the incandescent cathodes with the earth whereby, in addition to the electricity conveyed to them from the battery or machine which causes the incandescing, also the negative charge of the earth potential is conveyed, and (3) the connection of the positive and negative poles of the radiating collectors over a condenser circuit alone or with the introduction of a suitable inductive resistance, whereby simultaneously an oscillatory oscillation circuit may be obtained. The collecting effect is by these methods quite considerably increased.

I declare that what I claim is:—

1. An electrical energy generating system, comprising a conducting surface for static charges, means to support same at a distance above the earth, a conductor leading to the earth level, a spark gap associated with said conductor to convert electrostatic charges into electromagnetic high frequency oscillations means to supply said electromagnetic energy to a net work, and a spark gap of greatly increased relative resistance in parallel therewith.

2. An electrical energy generating system

comprising a conductor, means to support same above the earth level, an inductance therein, a spark gap associated with said conductor, a second spark gap of much higher relative resistance in parallel therewith and an energy receiving circuit coupled with the spark gap of lesser resistance.

3. An electrical energy generating system comprising a collecting surface, means to support same above the earth level, a conductor connecting said collecting surface with the earth level, a choke in said conductor, an electromagnetic resistance converting electrostatic energy to electromagnetic energy, a safety higher resistance in parallel therewith and a net work coupled with the conversion resistance of lesser value.

4. An electrical energy generating system comprising electric conductors spaced above the earth to form electromagnetic oscillating circuits, conductors connecting to earth level, electrostatic to electromagnetic energy conversion means therein, a safety high electrostatic resistance in parallel therewith and means to alter the electromagnetic characteristic of the circuits.

5. An electrical energy generating system comprising in combination a static collecting surface arranged above the earth, conductors connecting to earth level, a pair of

spark gaps in parallel of different electrostatic resistance, a utilization net work shunted across the spark gap of lesser resistance and an electromagnetic choke in said conductors.

6. An electrical energy generating system comprising an open circuit energy collecting aerial, a pair of sparking gaps in parallel of widely different resistance, connected thereto and a closed electric oscillation circuit in shunt across the gap of lesser resistance.

7. An electrical energy generating system comprising an open circuit energy collecting aerial, a pair of sparking gaps in parallel of widely different resistance connected thereto, a closed electric oscillation circuit in shunt across the gap of lesser resistance, a plurality of electrostatic collecting surfaces, means to connect said collecting surfaces in parallel in groups and means to connect said groups symmetrically with said aerial.

In witness whereof, I have hereunto signed my name this 30 day of Dec., 1920, in the presence of two subscribing witnesses.

HERMANN PLAUSON.

Witnesses:

H. F. ARMSTRONG,  
W. H. BEESTON.